



**THE DATASHEET OF
XC6206P302MR**



■ Product introduction

XC6206 series is a CMOS step-down voltage regulator with high ripple rejection, low power consumption, low dropout, overcurrent and short-circuit protection. These devices have a very low static bias current (6.0µA Typ.), which can provide an output current of 250mA even if the difference between the input and output voltages is very small, and still maintain a good regulation rate. Because the voltage difference between input and output is very small and the static bias current is very small, these devices are especially suitable for battery-powered products that want to prolong the battery life, such as computers, consumer products and industrial equipment.

■ Product features

- High precision output voltage: gear A: ±1%, gear B: ±2.5%
- Output voltage: 1.5V~5.0V (step size 0.1V)
- Very low static bias current (Typ.=6.0 µ A)
- Low temperature adjustment coefficient
- The highest input voltage can reach 8V.
- With strong load capacity: when Vin=4.3V and Vout=3.3V, Iout=250mA.
- It can be used as regulator and reference voltage.
- Good input stability: Typ. 0.03%/V
- Package form: SOT89-3, SOT23-3

■ product usage

- Battery power supply system
- Cordless telephone equipment
- Wireless control system
- Portable/palm computer
- Portable consumer equipment
- Portable instrument
- Automobile electronic equipment
- Voltage reference source

■ Package form and pin definition function

Pin serial number		Pin definition	function declaration
MR package	PR package		
SOT23-3	SOT89-3		
1	1	VSS	Chip grounding terminal
2	3	OUT	Output
3	2	VIN	Input

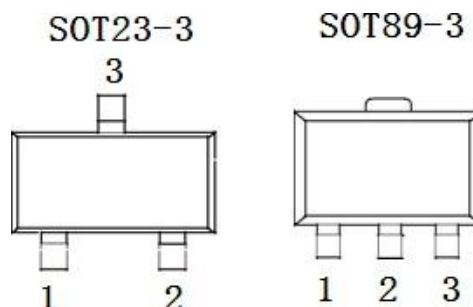

Model description

XC6206P

Representative number	describe	symbol	describe
	Output voltage	12-50	: e.g. output 3.0V =3, =0
	precision	2	: ±2.5%
		1	: ±1%
	package	M	: SOT-23
		P	: SOT-89
	Belt loading	R	: embossed belt, standard inflow

functional block diagram

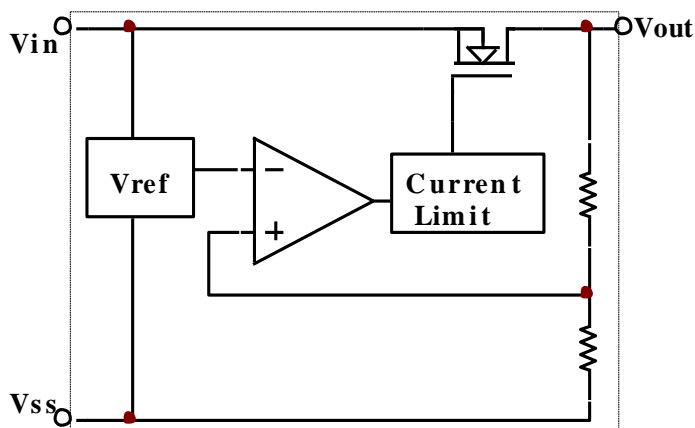

Limit parameter

project	symbol	parameter	limit value	unit
voltage	Vin	input voltage	9	V
	Vout	Output voltage	Vss-0.3 ~Vout+0.3	V
elect ricurrent	Iout	output current	500	mA
power consumption	PD	SOT23	Maximum allowable power consumption	300
		SOT89-3		500
temperature	Tw	Working temperature	-25~+80	°C
	Tc	Storage temperature	-40~+125	°C
	Th	welding temperature	260	°C ,10s

■ Electrical characteristics (C_{in}=C_{out}=10uF, T_a=25°C unless otherwise specified)

trait	symbol	condition	minimum value	typical value	maximum	unit
Output voltage	V _{OUT} (E)	I _{OUT} =1mA, V _{IN} = V _{OUT} (T)+1V	V _{OUT} (T) *0.98	V _{OUT} (T)	V _{OUT} (T)* 1.02	V
Maximum output current	I _{OUT} (max)	V _{IN} =V _{OUT} (T)+1V	100			mA
Drop pressure difference	V _{drop}	I _{OUT} =50mA	1.5V ≤ V _{OUT} (T) ≤ 2.5V	200	280	mV
			2.6V ≤ V _{OUT} (T) ≤ 3.3V	160	240	
			3.4V ≤ V _{OUT} (T) ≤ 5.5V	120	200	
quiescent current	I _{SS}	V _{IN} = V _{OUT} (T)+1V		7		μ A
Load stability	ΔV _{OUT}	V _{IN} = V _{OUT} (T)+1V, 1mA ≤ I _{OUT} ≤ 80mA		20		mV
Input stability	ΔV _{OUT} / (ΔV _{IN} • V _{OUT})	I _{OUT} =1mA, V _{OUT} (T)+0.5V ≤ V _{IN} ≤ 5.5V		0.1	0.2	%/V
Output voltage temperature coefficient	ΔV _{OUT} / (ΔT _a • V _{OUT})	V _{IN} = V _{OUT} (T)+1V, I _{OUT} =10mA -40°C ≤ T _a ≤ 85°C		±100		ppm/°C
input voltage	V _{IN}		1.8	—	8.0	V
Ripple suppression ratio	PSRR	V _{IN} = [V _{OUT} (T)+1]V +1Vp-pAC I _{OUT} =10mA, f=1kHz		40		dB
Short circuit current	I _{short}	V _{IN} = V _{OUT} (T)+1.5V , V _{OUT} =V _{SS}		30		mA
Overcurrent protection current	I _{limit}	V _{IN} = V _{OUT} (T)+1.5V		380		mA

Note:

1. V_{OUT} (T): the specified output voltage.
2. V_{OUT} (E): effective output voltage (that is, the output voltage when I_{OUT} keeps a certain value and V_{IN} = (V_{OUT} (T)+1.0V))
3. I_{OUT} (max): V_{IN}=V_{OUT}(T)+1V, slowly increase the output current, and the current value when the output voltage is ≤ V_{OUT}(E)*95%.
4. V_{drop} = V_{in1} - V_{out} (e) s: V_{in1} = the input voltage when the output voltage drops to 98% of V_{OUT} (E)1. V_{OUT} (E)s= V_{OUT} (E)*98%
V_{OUT} (E)1= the output voltage value when v_{in} = v_{out} (t)+1V and i_{out} = a certain value.

■ test circuit

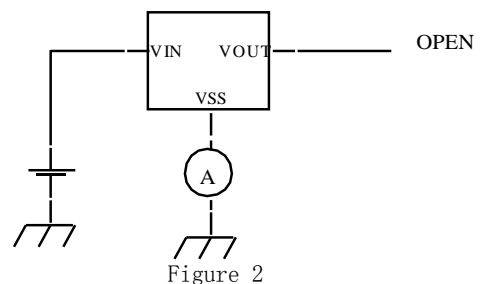
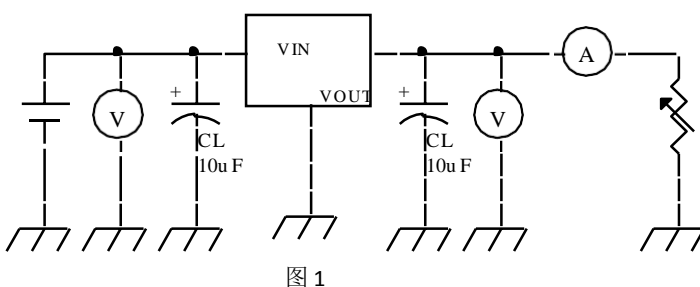

■ Applied circuit

1. Basic circuit

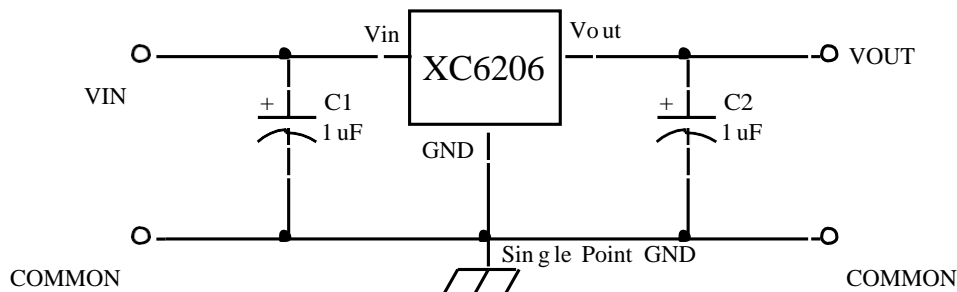

2. Positive voltage regulator with large output current

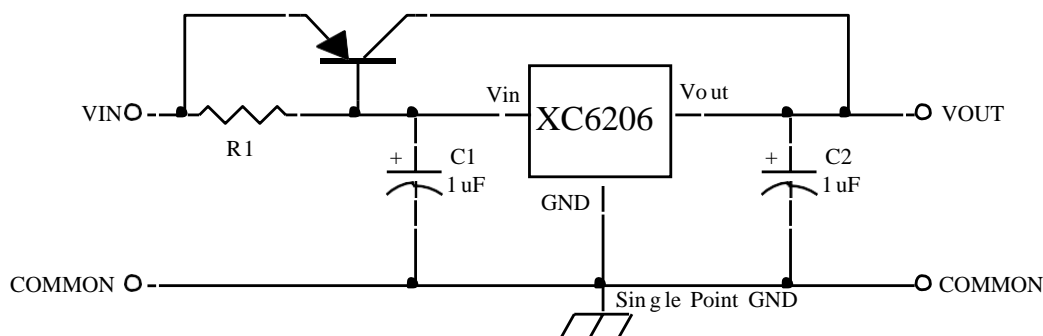

3. Circuit for increasing output voltage (1)

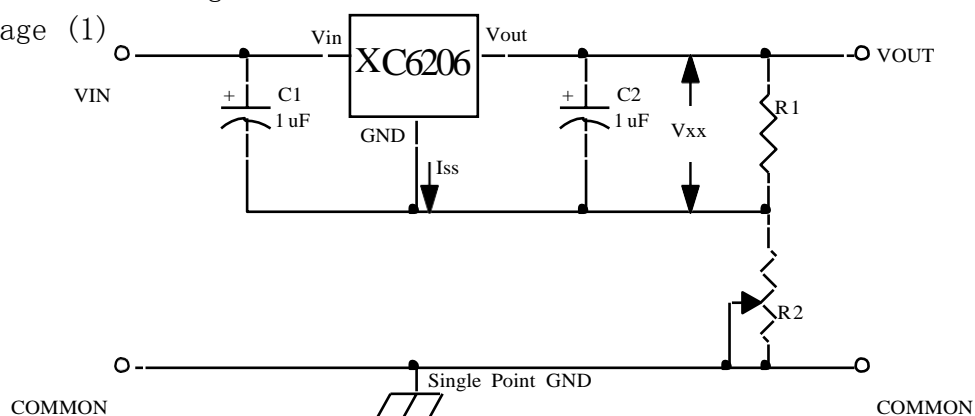

$$V_{out} = V_{xx}(1 + R_2/R_1) + I_{ss}R_2$$

4. Circuit for increasing output voltage (2)

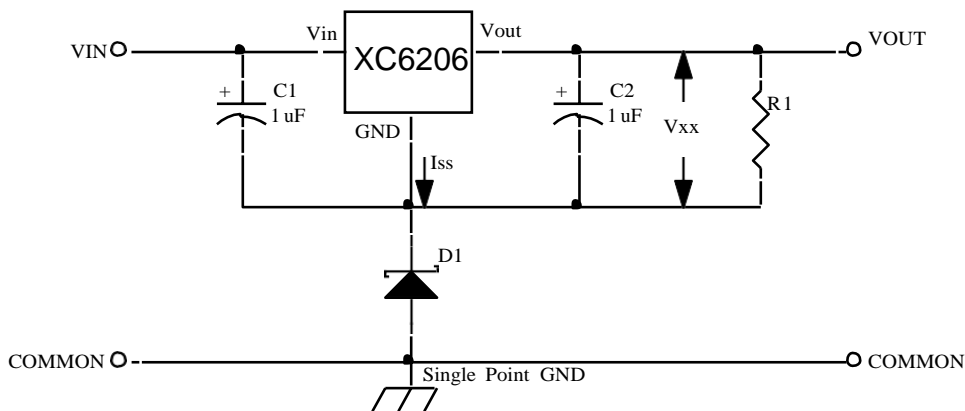

$$V_{out} = V_{xx} + V_{D1}$$

5. Constant current regulator

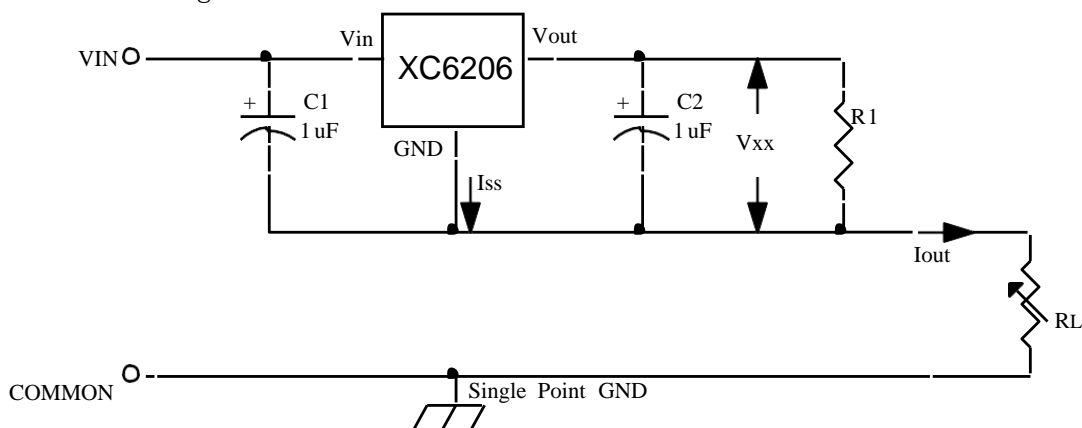

$$I_{out} = V_{xx} / R_A + I_{ss}$$

6. Double output

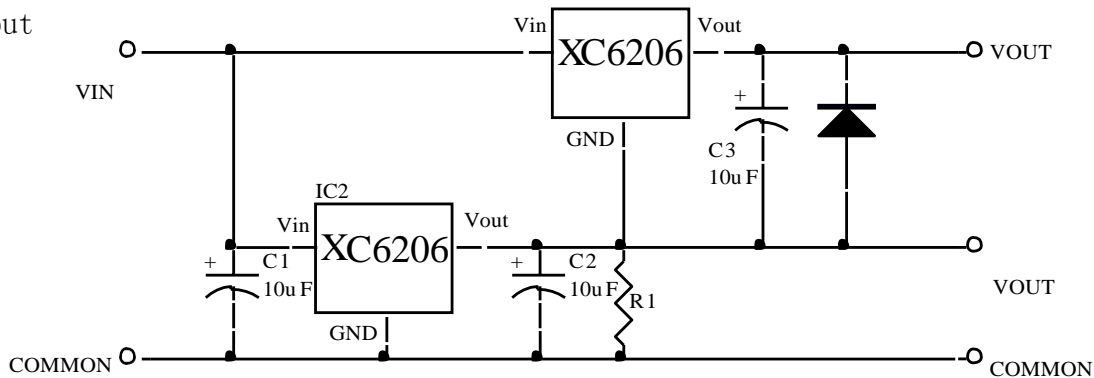

■ Characteristic curve

1. Output voltage-output current (when the load current increases)

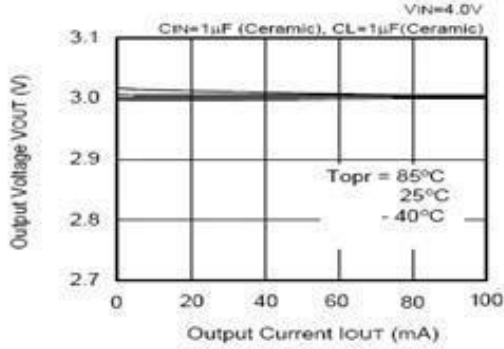

2. Output voltage and input voltage

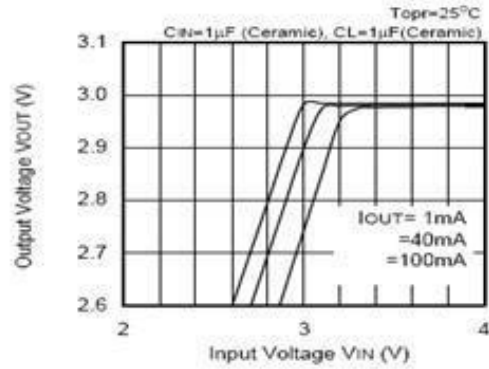

3. Dropout voltage and output current

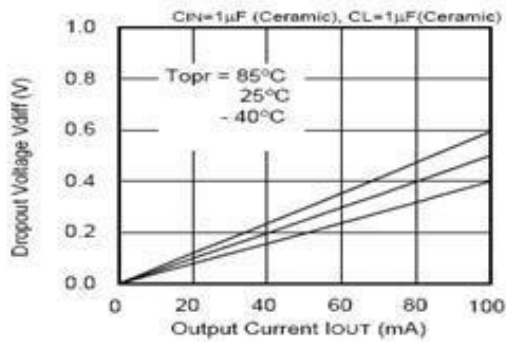

4. Dropout voltage and output voltage

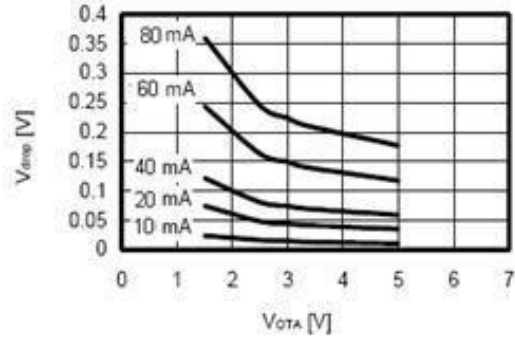

5. Output voltage and temperature

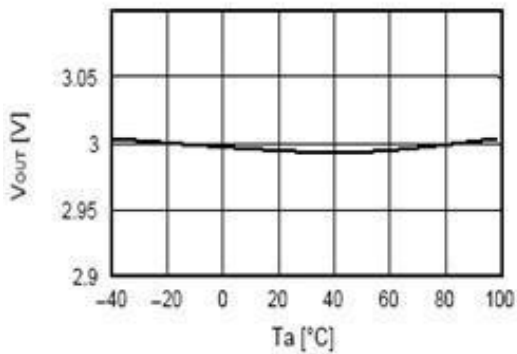

6. Ripple suppression

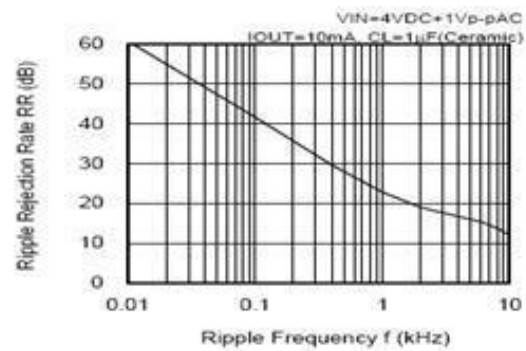

7. Transient response

Input transient response characteristics

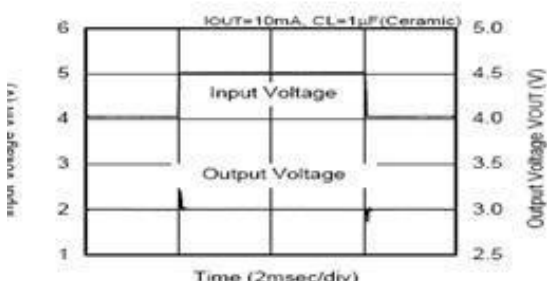

Load transient input response characteristics

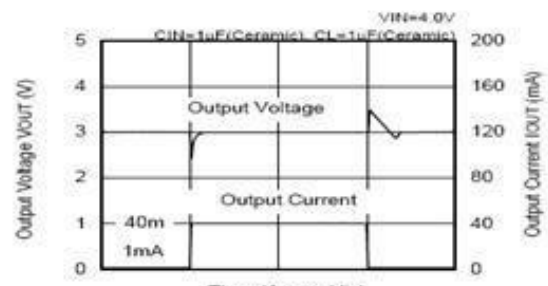

■ Package Information

SOT-89-3

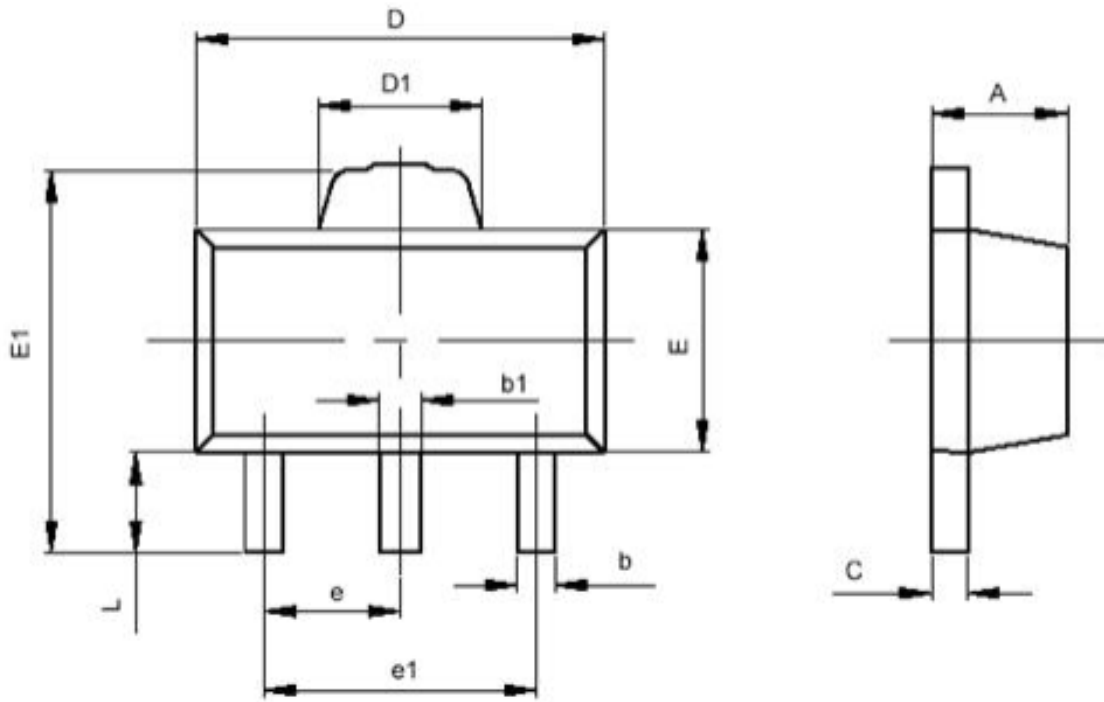

symbol	Minimum (mm)	Maximum (mm)
A	1.400	1.600
b	0.320	0.520
b1	0.360	0.560
c	0.350	0.440
D	4.400	4.600
D1	1.400	1.800
E	2.300	2.600
E1	3.940	4.250
e	1.500TYP	
e1	2.900	3.100
L	0.900	1.100

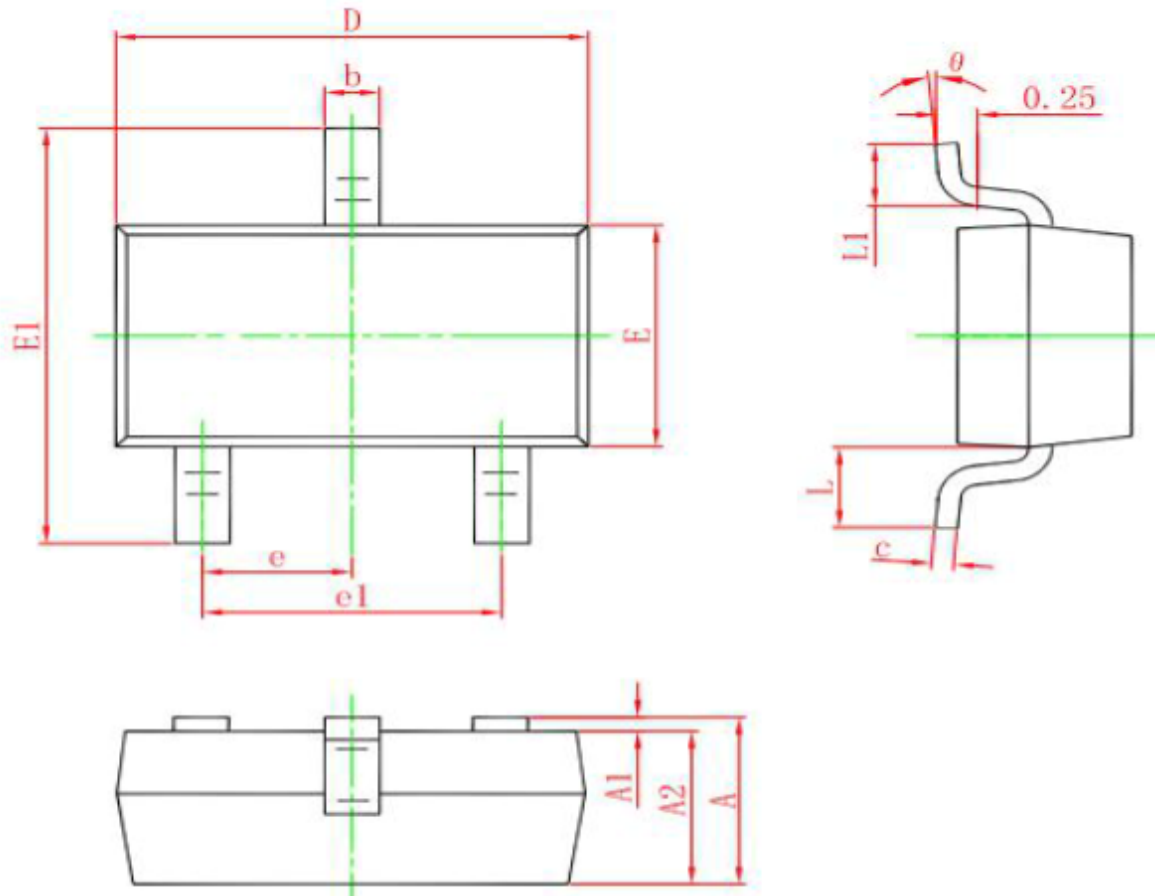

SOT-23







Symbol	Dimensions In Millimeters		Dimensions In Inches	
	Min.	Max.	Min.	Max.
A	0.900	1.150	0.035	0.045
A1	0.000	0.100	0.000	0.004
A2	0.900	1.050	0.035	0.041
b	0.300	0.500	0.012	0.020
c	0.080	0.150	0.003	0.006
D	2.800	3.000	0.110	0.118
E	1.200	1.400	0.047	0.055
E1	2.250	2.550	0.089	0.100
e	0.950 TYP.		0.037 TYP.	
e1	1.800	2.000	0.071	0.079
L	0.550 REF.		0.022 REF.	
L1	0.300	0.500	0.012	0.020
θ	0°	8°	0°	8°

Looking for pricing, stock, or lifecycle information?

Click below to explore more details on WIN SOURCE:

-  [View XC6206P302MR on WIN SOURCE](#)
-  [Torex Semiconductor Ltd Information](#)

Optimize Your Supply Chain with WIN SOURCE Solutions

-  Global Sourcing Solution
-  Obsolete Management
-  Cost Control Management
-  Shortage Management
-  Alternative Solution
-  Excess Inventory Management