



**THE DATASHEET OF
XC6210B322MR**



High Current, High Speed LDO Regulators

GENERAL DESCRIPTION

The XC6210 series are precise, low noise, high current, positive voltage low dropout regulators. They are fabricated using Torex's CMOS process.

The series features a voltage reference, an error amplifier, a current limiter, and a phase compensation circuit plus a driver transistor. With a low ON resistance driver transistor built into, batteries can be used until input-output voltage differential is minimal and can accordingly be used for a longer time.

The series is also compatible with low ESR ceramic capacitors which give added output stability.

The output voltage of the LDO is selectable in 0.05V increments within the range of 0.80V to 5.00V.

The current limiter's foldback circuit also operates as the output current limiter and the output pin protection.

The IC's internal regulator circuit can be placed in stand-by mode via the CE function. In the stand-by mode, power consumption is greatly reduced.

APPLICATIONS

- Optical disk drive
- Magnetic disk drive
- Digital still cameras / Camcorders
- Digital audio equipments
- Multi-function power supplies

FEATURES

- Maximum Output Current** : More than 700mA
(800mA limit, TYP.)
($1.60V \leq V_{OUT} \leq 5.00V$)
- Dropout Voltage** : 50mV @ 100mA
: 100mV @ 200mA
- Operating Voltage Range** : 1.50V ~ 6.00V
- Output Voltage Range** : 0.80V ~ 5.00V (0.05V increments)
- Highly Accurate** : $\pm 2\%$ (1.55V V_{OUT} 5.00V)
: $\pm 30mV$ (0.80V V_{OUT} 1.50V)
- Low Power Consumption** : 35 μA (TYP.)
- High Ripple Rejection** : 60dB @ 1kHz
- Operational Ambient Temperature** : -40 ~ +85

CMOS

Low ESR Capacitor Compatible

- Packages** : SOT-25
: SOT-89-5
: USP-6B

Environmentally Friendly : EU RoHS Compliant, Pb Free

TYPICAL APPLICATION CIRCUIT



TYPICAL PERFORMANCE CHARACTERISTICS

Dropout Voltage vs. Output Current



PIN CONFIGURATION



SOT-25
(TOP VIEW)



SOT-89-5
(TOP VIEW)



USP-6B
(BOTTOM VIEW)

*The dissipation pad for the USP-6B package should be solder-plated in reference mount pattern and metal masking so as to enhance mounting strength and heat release. If the pad needs to be connected to other pins, it should be connected to the V_{SS} pins.

PIN ASSIGNMENT

PIN NUMBER			PIN NAME	FUNCTION
SOT-25	SOT-89-5	USP-6B		
3	1	1	CE	ON/OFF Control
1	4	3	V _{IN}	Power Input
2	2	4	V _{SS}	Ground
5	5	5	V _{OUT}	Output
4	3	2, 6	NC	No Connection

LOGIC CONDIFION FOR THE PIN

PIN NAME	DESIGNATOR	CONDITIONS
CE	H	1.3V V _{CE} 6.0V
	L	V _{CE} 0.25V

* V_{CE} : CE pin voltage

PIN FUNCTION ASSIGNMENT

1) XC6210A Type (CE High Active, CE pull-down resistor)

CE	IC Operation ON/OFF
"H" Level	ON
"L" Level	OFF
"OPEN"	

2) XC6210B Type (CE High Active, CE no pull-down resistor)

CE	IC Operation ON/OFF
"H" Level	ON
"L" Level	OFF
"OPEN"	Undefined state

3) XC6210C Type (CE Low Active, CE pull-up resistor)

CE	IC Operation ON/OFF
"H" Level	OFF
"L" Level	ON
"OPEN"	OFF

4) XC6210D Type (CE Low Active, CE no pull-up resistor)

CE	IC Operation ON/OFF
"H" Level	OFF
"L" Level	ON
"OPEN"	Undefined state

PRODUCT CLASSIFICATION

Ordering Information

XC6210 _____ - ^(*)

DESIGNATOR	ITEM	SYMBOL	DESCRIPTION
	CE Pin Functions	A	High Active with pull-down resistor
		B	High Active with no pull-down resistor
		C	Low Active with pull-up resistor
		D	Low Active with no pull-up resistor
	Output Voltage	08~50	ex.) 3.00V =3, =0
	Output Voltage (The second place of decimal point)	2	0.10V increments ex.) 3.00V =3, =0, =2
		A	0.05V increments ex.) 3.05V =3, =0, =A
- ^(*)	Packages (Oder Unit)	MR	SOT-25 (3,000/Reel)
		MR-G	SOT-25 (3,000/Reel)
		PR	SOT-89-5 (1,000/Reel)
		PR-G	SOT-89-5 (1,000/Reel)
		DR	USP-6B (3,000/Reel)
		DR-G	USP-6B (3,000/Reel)

^(*) The "-G" suffix indicates that the products are Halogen and Antimony free as well as being fully EU RoHS compliant.

BLOCK DIAGRAM



XC6210A Series



XC6210B/D Series



XC6210C Series

*Diodes shown in the above circuit are ESD protection diodes and parasitic diodes

ABSOLUTE MAXIMUM RATINGS

Ta=25

PARAMETER	SYMBOL	RATINGS	UNITS	
Input Voltage	V _{IN}	6.5	V	
Output Current *	I _{OUT}	900	mA	
Output Voltage	V _{OUT}	V _{SS} -0.3 ~ V _{IN} +0.3	V	
CE Pin Voltage	V _{CE}	V _{SS} -0.3 ~ 6.5	V	
Power Dissipation	SOT-25	250	mW	
		600 (PCB mounted) *2		
		SOT-89-5		500
		1300 (PCB mounted) *2		
Power Dissipation	USP-6B	100	mW	
		1000 (PCB mounted) *2		
Operating Temperature Range	T _{opr}	- 40 ~ + 85		
Storage Temperature Range	T _{stg}	- 55 ~ + 125		

*1: I_{OUT}=Pd / (V_{IN} - V_{OUT})

*2: The power dissipation figure shown is PCB mounted. Please refer to pages 22 to 24 for details.

ELECTRICAL CHARACTERISTICS

XC6210 series

Ta=25

PARAMETER	SYMBOL	CONDITIONS	MIN.	TYP.	MAX.	UNIT	CIRCUIT
Output Voltage	V _{OUT(E)} ⁽³⁾	V _{IN} =V _{OUT(T)} +1.0V, I _{OUT} =30mA V _{CE} =ON (V _{IN} or V _{SS}) (V _{OUT(T)} > 1.50V)	x 0.98	V _{OUT(T)} ⁽²⁾	x 1.02	V	
		V _{IN} =V _{OUT(T)} +1.0V, I _{OUT} =30mA, V _{CE} =ON(V _{IN} or V _{SS})(V _{OUT(T)} 1.50V)	(-30mV)	V _{OUT(T)} ⁽²⁾	(+30mV)		
Maximum Output Current	I _{OUTMAX}	V _{IN} =V _{OUT(T)} +1.0V, V _{CE} =ON(V _{IN} or V _{SS}) (V _{OUT(T)} > 1.50V)	700	-	-	mA	
		V _{IN} =V _{OUT(T)} +1.0V, V _{CE} =ON(V _{IN} or V _{SS}) (V _{OUT(T)} 1.50V)	500	-	-		
Load Regulation	V _{OUT}	1mA ≤ I _{OUT} ≤ 100mA, V _{CE} =ON(V _{IN} or V _{SS})	-	15	60	mV	
Dropout Voltage	V _{dif1} ⁽⁴⁾	I _{OUT} =30mA, V _{CE} =ON(V _{IN} or V _{SS})	E-1			mV	
	V _{dif2} ⁽⁴⁾	I _{OUT} =100mA, V _{CE} =ON(V _{IN} or V _{SS})	E-2				
Supply Current (A type)	I _{DD}	V _{IN} =V _{CE} =V _{OUT(T)} +1.0V	E-3			μA	
Supply Current (B type)		V _{IN} =V _{CE} =V _{OUT(T)} +1.0V	-	35	55		
Supply Current (C type)		V _{IN} =V _{OUT(T)} +1.0V, V _{CE} =V _{SS}	E-3				
Supply Current (D type)		V _{IN} =V _{OUT(T)} +1.0V, V _{CE} =V _{SS}	-	35	55		
Stand-by Current	I _{STBY}	V _{IN} =6.0V, V _{CE} =OFF(V _{IN} or V _{SS})	-0.10	-	0.10	μA	
Line Regulation	$\frac{V_{OUT}}{V_{IN} \cdot V_{OUT}}$	V _{OUT(T)} +1.0V V _{IN} 6.0V V _{CE} =ON(V _{IN} or V _{SS}), I _{OUT} =30mA V _{OUT(T)} < 4.50V	-	0.01	0.20	% / V	
		5.5V V _{IN} 6.0V V _{CE} =ON(V _{IN} or V _{SS}), I _{OUT} =30mA V _{OUT(T)} 4.50V					
Input Voltage	V _{IN}	-	1.5	-	6.0	V	-
Output Voltage Temperature Characteristics	$\frac{V_{OUT}}{T_{opr} \cdot V_{OUT}}$	I _{OUT} =30mA, V _{CE} =ON (V _{IN} or V _{SS}) -40 T _{opr} 85	-	± 100	-	ppm/	
Ripple Rejection Rate	PSRR	V _{IN} =[V _{OUT(T)} +1.0]V _{DC} +0.5V _{P-PAC} V _{CE} =ON(V _{IN} or V _{SS}), I _{OUT} =30mA, f=1kHz V _{OUT(T)} < 4.75V	-	60	-	dB	
		V _{IN} =5.75V _{DC} +0.5V _{P-PAC} V _{CE} =ON(V _{IN} or V _{SS}), I _{OUT} =30mA, f=1kHz V _{OUT(T)} 4.75V					
Current Limiter	I _{LIM}	V _{IN} =V _{OUT(T)} +1.0V, V _{CE} =ON(V _{IN} or V _{SS}) V _{OUT(T)} > 1.50V	700	800	-	mA	
		V _{IN} =V _{OUT(T)} +1.0V, V _{CE} =ON(V _{IN} or V _{SS}) V _{OUT(T)} 1.50V	-	800	-		
Short-Circuit Current	I _{SHORT}	V _{IN} =V _{OUT(T)} +1.0V, V _{CE} =ON(V _{IN} or V _{SS})	-	50	-	mA	
CE "High" Level Voltage	V _{CEH}	-	1.3	-	6.0	V	
CE "Low" Level Voltage	V _{CEL}	-	-	-	0.25		
CE "High" Level Current (A type)	I _{CEH}	V _{CE} =V _{IN} =V _{OUT(T)} +1.0V	E-4	-	E-4	μA	
CE "High" Level Current (B / C / D type)		V _{CE} =V _{IN} =V _{OUT(T)} +1.0V	- 0.10	-	0.10		
CE "Low" Level Current (C type)	I _{CEL}	V _{IN} =V _{OUT(T)} +1.0V, V _{CE} =V _{SS}	E-5	-	E-5	μA	
CE "Low" Level Current (A / B / D type)		V _{IN} =V _{OUT(T)} +1.0V, V _{CE} =V _{SS}	- 0.10	-	0.10		

NOTE:

*1: Unless otherwise stated, V_{IN}=V_{OUT(T)}+1.0V

*2: V_{OUT(T)}=Specified output voltage

*3: V_{OUT(E)}=Effective output voltage

(i.e. the output voltage when "V_{OUT(T)}+1.0V" is provided while maintaining a certain I_{OUT} value).

*4: V_{dif}={V_{IN1}⁽⁶⁾-V_{OUT1}⁽⁵⁾}

*5: A voltage equal to 98% of the output voltage whenever a stabilized V_{OUT1}=I_{OUT}{V_{OUT(T)}+1.0V} is input.

*6: V_{IN1}= the input voltage when V_{OUT1}, which appears as input voltage is gradually decreased.

*7: V_{CE} conditions: XC6210A / B type: ON=V_{IN}, OFF=V_{SS}

XC6210C / D type: ON=V_{SS}, OFF=V_{IN}

VOLTAGE CHART

Dropout Voltage, Supply Current, CE "H / L" Level Current Chart

Ta=25

SETTING OUTPUT VOLTAGE	OUTPUT VOLTAGE		E-1		E-2		E-3		E-4		E-5								
			DROPOUT VOLTAGE 1 (I _{OUT} =30mA)		DROPOUT VOLTAGE 2 (I _{OUT} =100mA)		SUPPLY CURRENT		CE "H" LEVEL CURRENT		CE "L" LEVEL CURRENT								
(V)	(V)		(mV)		(mV)		(μA)		(μA)		(μA)								
V _{OUT(T)}	V _{OUT}		V _{dif1}		V _{dif2}		I _{DD}		I _{CEH}		I _{CEL}								
	MIN.	MAX.	TYP.	MAX.	TYP.	MAX.	TYP.	MAX.	MIN.	MAX.	MIN.	MAX.							
0.80	0.770	0.830	100.0	700.0	250.0	800.0	38.0	60.0	1.50	5.00	-5.00	-1.50							
0.85	0.820	0.880		600.0		700.0													
0.90	0.870	0.930		50.0	500.0	150.0							600.0	38.5	61.5	2.00	6.50	-6.50	-2.00
0.95	0.920	0.980			400.0								500.0						
1.00	0.970	1.030	30.0		300.0	100.0	400.0	39.0	63.0	2.50	8.00	-8.00	-2.50						
1.05	1.020	1.080			200.0		300.0												
1.10	1.070	1.130		100.0	250.0														
1.15	1.120	1.180		27.0	41.0		90.0							135.0	39.0	63.0	2.50	8.00	-8.00
1.20	1.170	1.230																	
1.25	1.220	1.280																	
1.30	1.270	1.330																	
1.35	1.320	1.380																	
1.40	1.370	1.430																	
1.45	1.420	1.480																	
1.50	1.470	1.530																	
1.55	1.519	1.581																	
1.60	1.568	1.632																	
1.65	1.617	1.683																	
1.70	1.666	1.734																	
1.75	1.715	1.785																	
1.80	1.764	1.836																	
1.85	1.813	1.887																	
1.90	1.862	1.938																	
1.95	1.911	1.989																	
2.00	1.960	2.040	25.0	37.0	80.0	120.0	39.5	64.5	3.00	9.50	-9.50	-3.00							
2.05	2.009	2.091																	
2.10	2.058	2.142																	
2.15	2.107	2.193																	
2.20	2.156	2.244																	
2.25	2.205	2.295																	
2.30	2.254	2.346																	
2.35	2.303	2.397																	
2.40	2.352	2.448																	
2.45	2.401	2.499																	
2.50	2.450	2.550	18.0	28.0	60.0	90.0	40.0	66.0	3.50	11.00	-11.00	-3.50							
2.55	2.499	2.601																	
2.60	2.548	2.652																	
2.65	2.597	2.703																	
2.70	2.646	2.754																	
2.75	2.695	2.805																	
2.80	2.744	2.856																	
2.85	2.793	2.907																	
2.90	2.842	2.958																	
2.95	2.891	3.009																	

VOLTAGE CHART (Continued)

Dropout Voltage, Supply Current, CE "H / L" Level Current Chart

Ta=25

SETTING OUTPUT VOLTAGE	OUTPUT VOLTAGE		E-1		E-2		E-3		E-4		E-5	
			DROPOUT VOLTAGE 1 (I _{OUT} =30mA)		DROPOUT VOLTAGE 2 (I _{OUT} =100mA)		SUPPLY CURRENT		CE "H" LEVEL CURRENT		CE "L" LEVEL CURRENT	
(V)	(V)		(mV)		(mV)		(μA)		(μA)		(μA)	
V _{OUT(T)}	V _{OUT}		V _{dif1}		V _{dif2}		I _{DD}		I _{CEH}		I _{CEL}	
	MIN.	MAX.	TYP.	MAX.	TYP.	MAX.	TYP.	MAX.	MIN.	MAX.	MIN.	MAX.
3.00	2.940	3.060	15.0	23.0	50.0	75.0	40.5	67.5	4.00	12.50	-12.50	-4.00
3.05	2.989	3.111										
3.10	3.038	3.162										
3.15	3.087	3.213										
3.20	3.136	3.264										
3.25	3.185	3.315										
3.30	3.234	3.366										
3.35	3.283	3.417										
3.40	3.332	3.468										
3.45	3.381	3.519										
3.50	3.430	3.570	15	23	50	75	41.0	69.0	4.40	14.00	-14.00	-4.40
3.55	3.479	3.621										
3.60	3.528	3.672										
3.65	3.577	3.723										
3.70	3.626	3.774										
3.75	3.675	3.825										
3.80	3.724	3.876										
3.85	3.773	3.927										
3.90	3.822	3.978										
3.95	3.871	4.029										
4.00	3.920	4.080	15.0	23.0	50.0	75.0	41.5	70.5	4.85	15.50	-15.50	-4.85
4.05	3.969	4.131										
4.10	4.018	4.182										
4.15	4.067	4.233										
4.20	4.116	4.284										
4.25	4.165	4.335										
4.30	4.214	4.386										
4.30	4.214	4.386										
4.40	4.312	4.488										
4.45	4.361	4.539										
4.50	4.410	4.590										
4.55	4.459	4.641										
4.60	4.508	4.692										
4.65	4.557	4.743										
4.70	4.606	4.794										
4.75	4.655	4.845										
4.80	4.704	4.896										
4.85	4.753	4.947										
4.90	4.802	4.998										
4.95	4.851	5.049										
5.00	4.900	5.100					42.0	72.0	5.30	17.00	-17.00	-5.30

TEST CIRCUITS

Circuit

(Output Voltage, Maximum Output Voltage, Load Regulation, Dropout Voltage, Line Regulation, Output Voltage Temperature Characteristics, Current Limiter, Short-Circuit Current, CE "H" "L" Level Voltage, CE "H" "L" Level Current)



Circuit (Supply Current, Stand-by Current)



Circuit (Ripple Rejection Rate)



Output Capacitor Corresponding Chart

OUTPUT VOLTAGE	CL
0.80V ~ 1.45V	More than 6.8 μ F
1.50V ~ 1.75V	More than 4.7 μ F
1.80V ~ 5.00V	More than 1.0 μ F

OPERATIONAL EXPLANATION

<Output Voltage Regulator Control>

The voltage, divided by resistors R1 & R2, which are connected to the V_{OUT} pin is compared with the internal reference voltage by the error amplifier. The P-channel MOSFET, which is connected to the V_{OUT} pin, is then driven by the subsequent output signal. The output voltage at the V_{OUT} pin is controlled & stabilized by negative feedback. The constant current limit circuit and short circuit protection operate in relation to the level of output current.



<Low ESR Capacitor>

With the XC6210 series regulator, a stable output voltage is achievable even if low ESR capacitors are used, as a phase compensation circuit is built into the regulator. In order to ensure the effectiveness of the phase compensation, we suggest that an output capacitor (C_L) be connected as close as possible, between the output pin (V_{OUT}) and the V_{SS} pin. Please use an output capacitor (C_L) with a capacitance, based on the chart below. We also suggest an input capacitor (C_{IN}) of $1.0\mu\text{F}$: this should be connected between V_{IN} and V_{SS} in order to stabilize input power source.

Output Capacitor Corresponding Chart

V_{OUT}	C_L
0.80V ~ 1.45V	More than $6.8\ \mu\text{F}$
1.50V ~ 1.75V	More than $4.7\ \mu\text{F}$
1.80V ~ 5.00V	More than $1.0\ \mu\text{F}$

<Current Limiter, Short-Circuit Protection>

The XC6210 series regulator offers a combination of current limit and short circuit protection by means of a built-in fixed current limiter circuit and a foldback circuit. When the load current reaches the current limit level, the fixed current limiter circuit operates and output voltage drops. As a result of this drop in output voltage, the foldback circuit operates, the output voltage drops further and output current decreases. When the output pin is shorted, a current of about 50mA flows.

<CE Pin>

The IC's internal regulator circuitry can be shut down via the signal from the CE pin with the XC6210 series. In shutdown mode, output at the V_{OUT} pin will be pulled down to the V_{SS} level via R1 & R2. Options are available for the CE pin logic (See the product classification). Note that as the XC6210B types are 'High Active / No Pull-Down', operations will become unstable with the CE pin open. Although the CE pin is equal to an inverter input with CMOS hysteresis, with either the pull-up or pull-down options, the CE pin input current will increase when the IC is in operation. We suggest that you use this IC with either a V_{IN} voltage or a V_{SS} voltage input at the CE pin. If this IC is used with the correct specifications for the CE pin, the IC will operate normally. However, supply current may increase as a result of through current in the IC's internal circuitry if a voltage other than V_{IN} or V_{SS} is applied.

NOTES ON USE

1. Please use this IC within the stated absolute maximum ratings. For temporary, transitional voltage drop or voltage rising phenomenon, the IC is liable to malfunction should the ratings be exceeded.
2. Where wiring impedance is high, operations may become unstable due to noise and/or phase lag depending on output current. Please strengthen V_{IN} and V_{SS} wiring in particular.
3. Please wire the input capacitor (C_{IN}) and the output capacitor (C_L) as close to the IC as possible. If rapid input fluctuation or load fluctuation should occur, please increase the capacitor value such as C_{IN} or C_L more than the recommended values to stabilize the operation.
4. Torex places an importance on improving our products and its reliability.
However, by any possibility, we would request user fail-safe design and post-aging treatment on system or equipment.

TYPICAL PERFORMANCE CHARACTERISTICS

(1) Output Voltage vs. Output Current

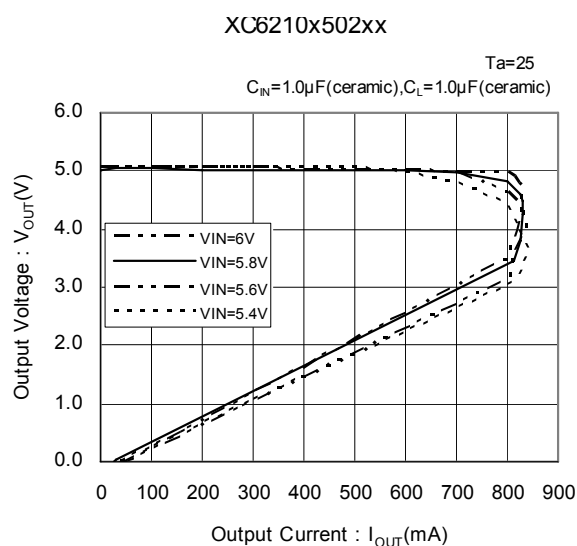

TYPICAL PERFORMANCE CHARACTERISTICS (Continued)

(2) Output Voltage vs. Input Voltage

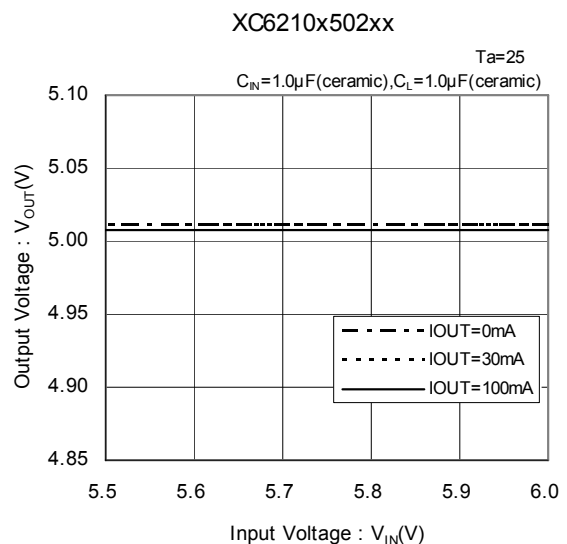
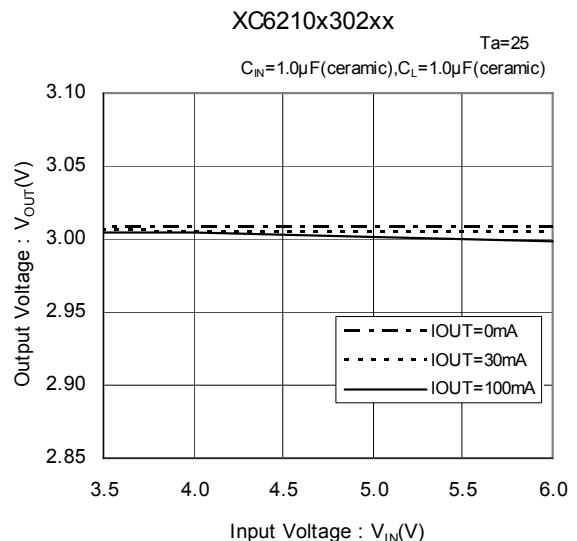
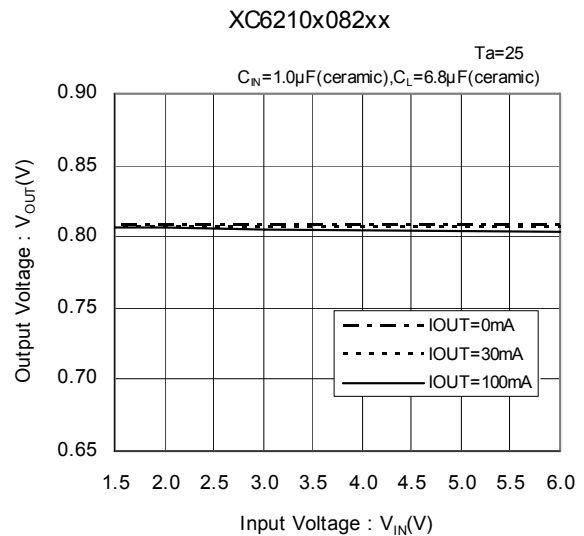

TYPICAL PERFORMANCE CHARACTERISTICS (Continued)

(3) Dropout Voltage vs. Output Current



TYPICAL PERFORMANCE CHARACTERISTICS (Continued)

(4) Supply Current vs. Input Voltage

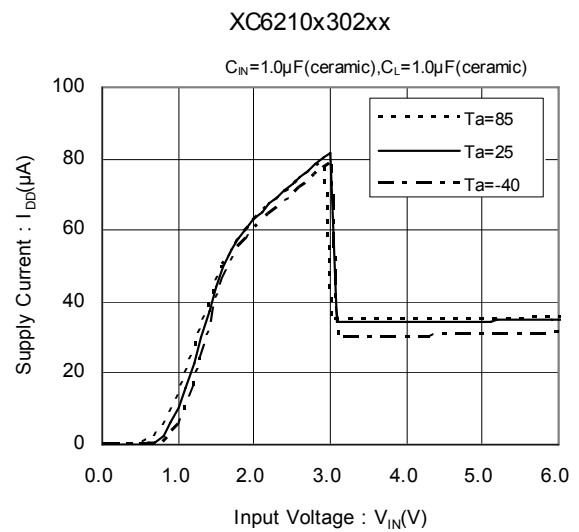
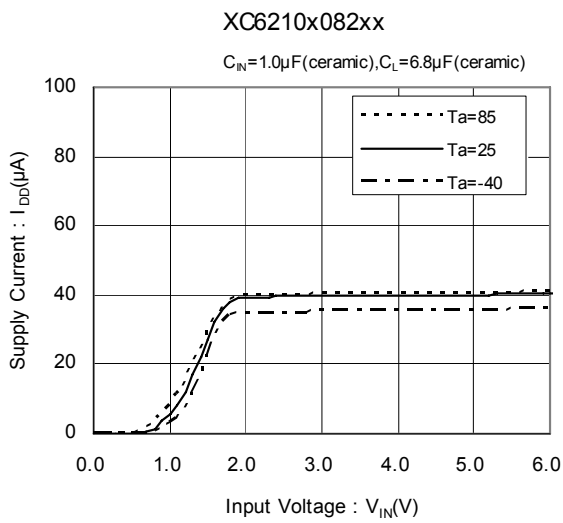

(5) Output Voltage vs. Ambient Temperature

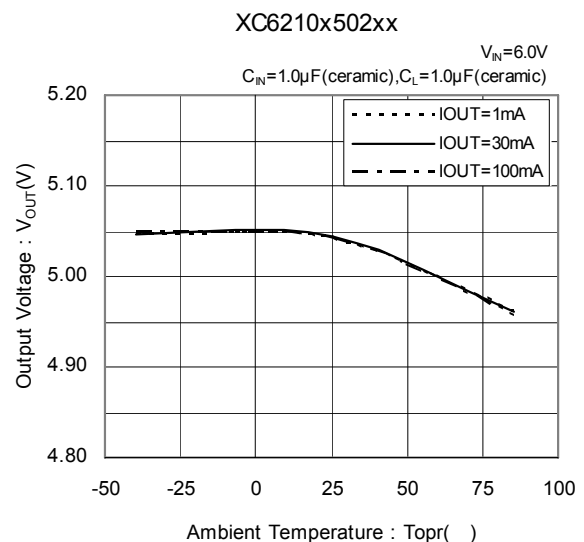
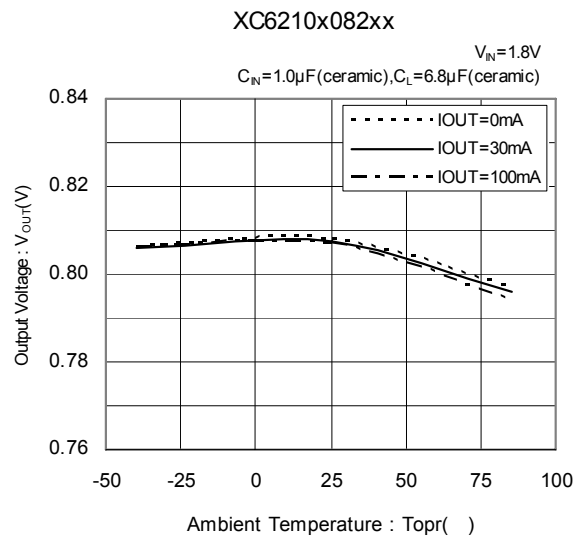

TYPICAL PERFORMANCE CHARACTERISTICS (Continued)

(6) Supply Current vs. Ambient Temperature



(7) CE Pin Threshold Voltage vs. Ambient Temperature



TYPICAL PERFORMANCE CHARACTERISTICS (Continued)

(8) Input Transient Response 1

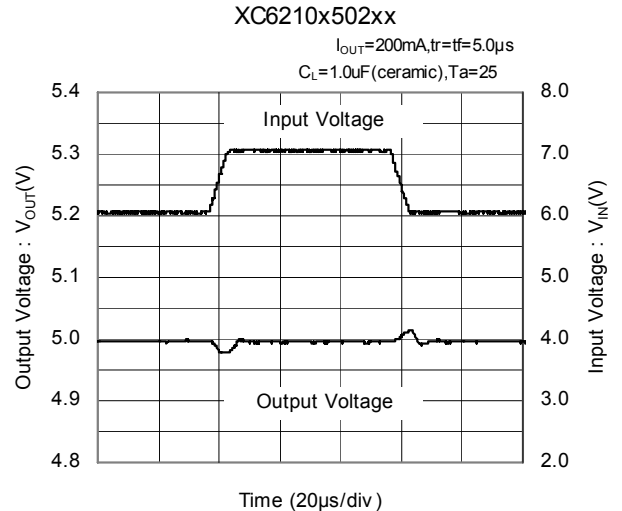
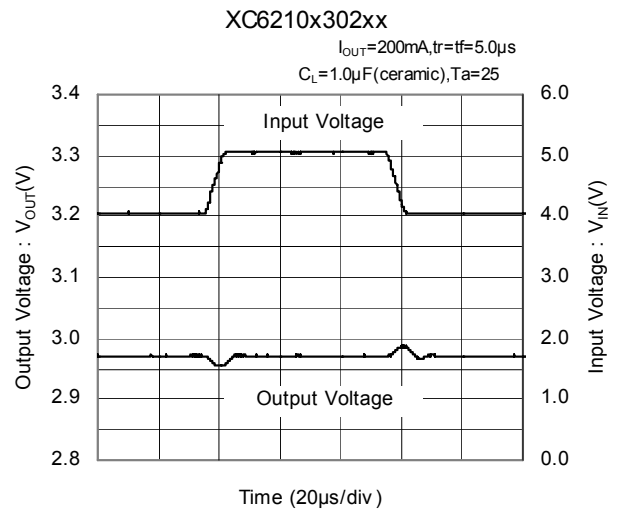
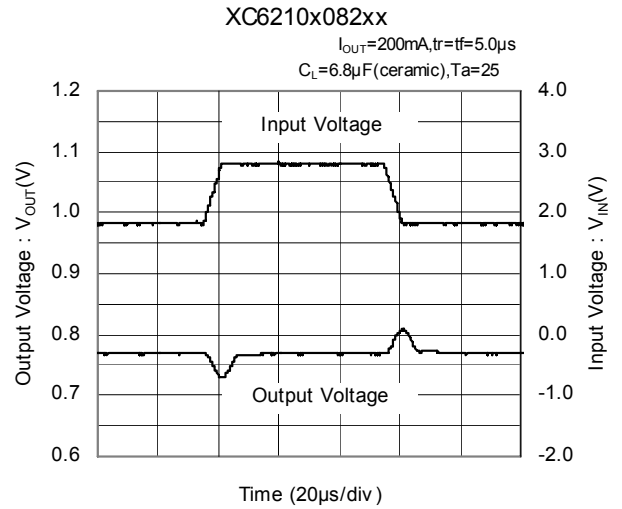

TYPICAL PERFORMANCE CHARACTERISTICS (Continued)

(9) Load Transient Response

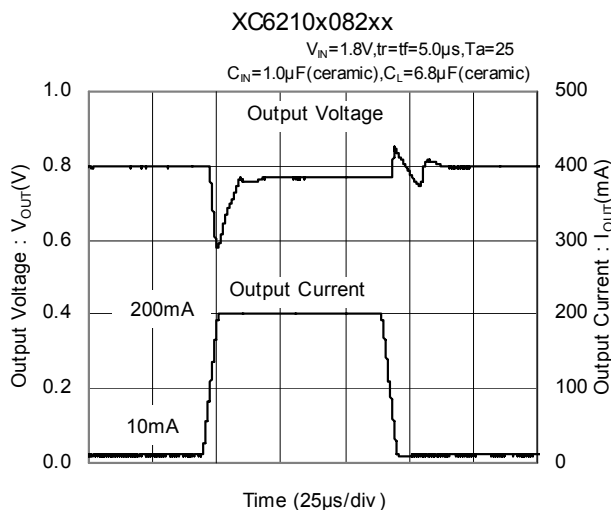
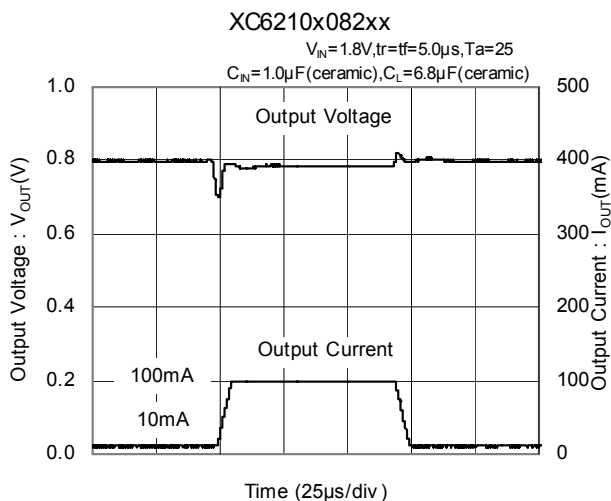

TYPICAL PERFORMANCE CHARACTERISTICS (Continued)

(10) Ripple Rejection Rate

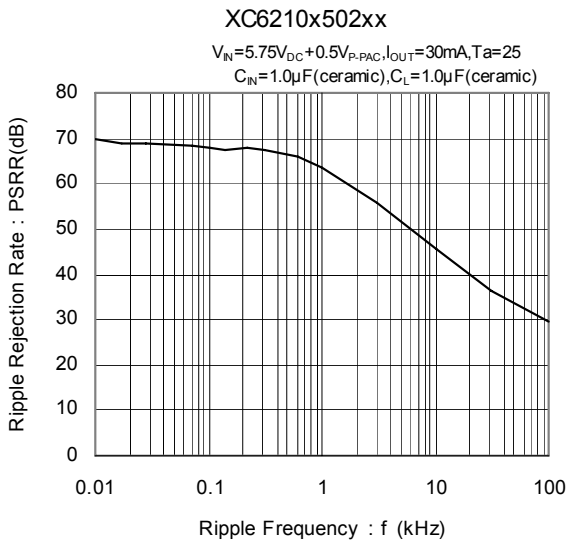
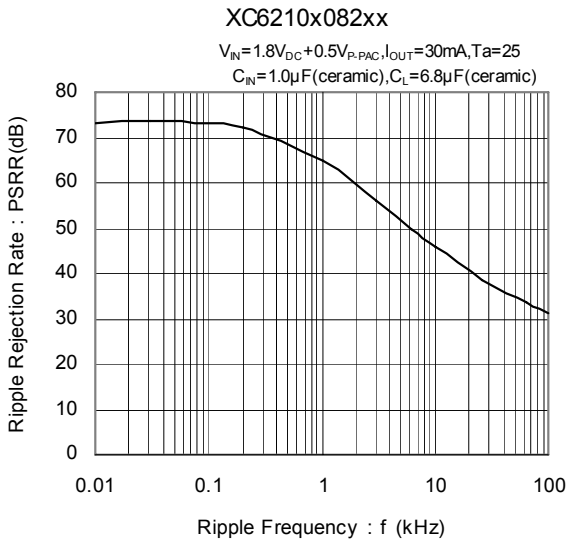

TYPICAL PERFORMANCE CHARACTERISTICS (Continued)

(11) Input Transient Response 2

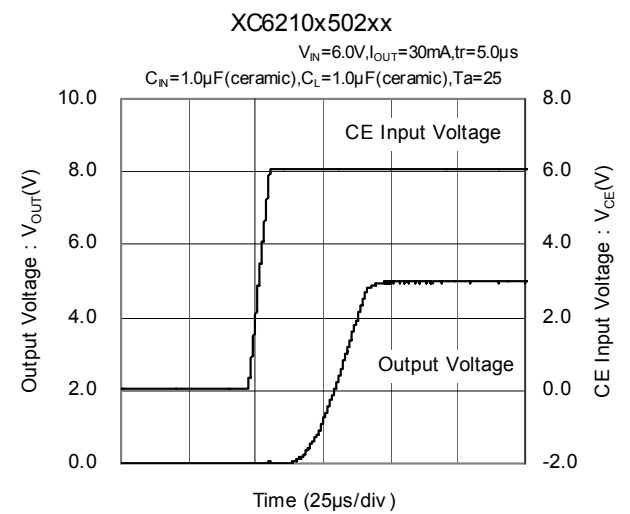
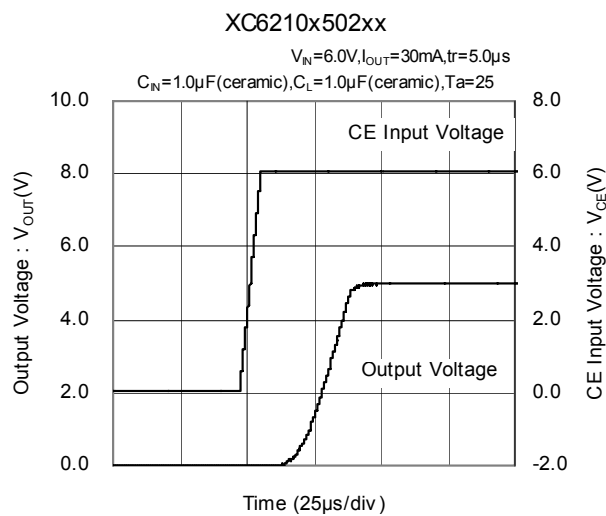
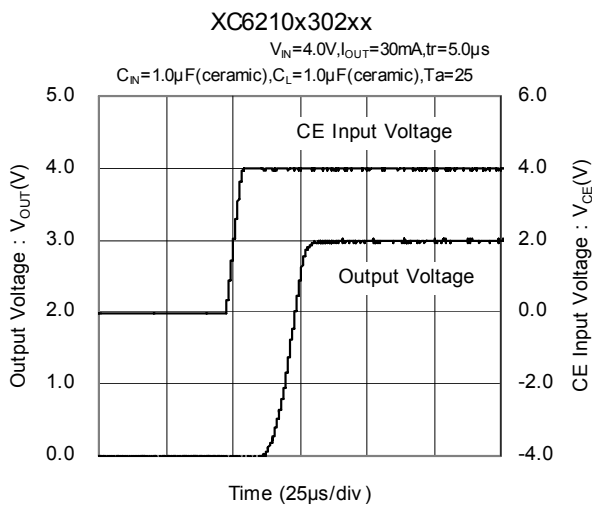
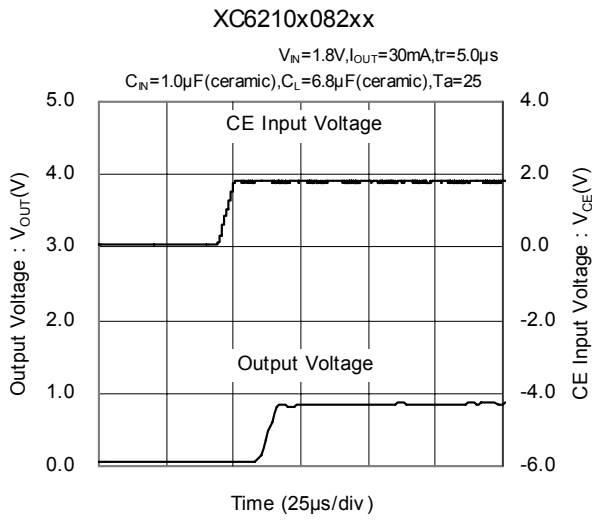

PACKAGING INFORMATION

SOT-25

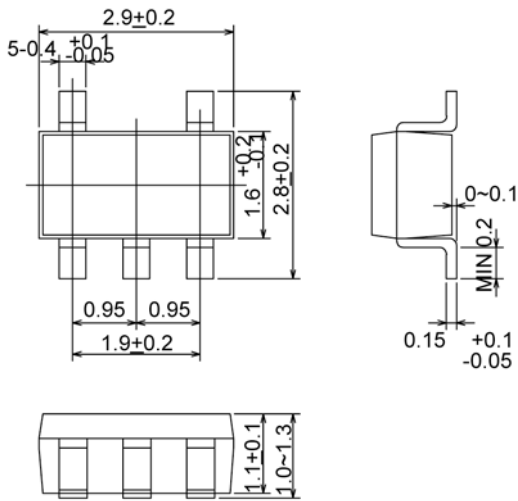

(unit : mm)

SOT-89-5



(unit : mm)

USP-6B

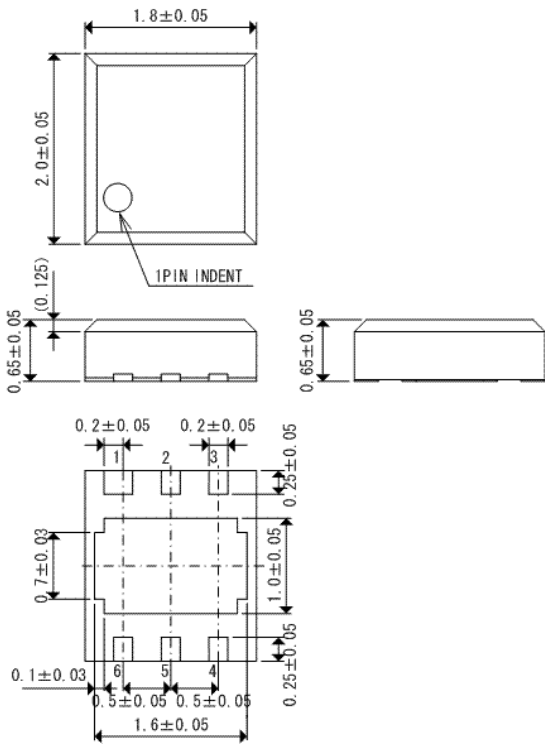

(unit : mm)

PACKAGING INFORMATION (Continued)

USP-6B Reference Pattern Layout



(unit : mm)

USP-6B Reference Metal Mask Design

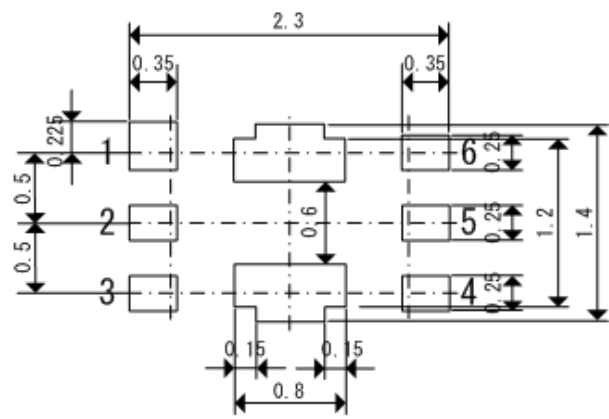

(unit : mm)

PACKAGING INFORMATION (Continued)

SOT-25 Power Dissipation

Power dissipation data for the SOT-25 is shown in this page.
 The value of power dissipation varies with the mount board conditions.
 Please use this data as one of reference data taken in the described condition.

1. Measurement Condition (Reference data)

- Condition: Mount on a board
- Ambient: Natural convection
- Soldering: Lead (Pb) free
- Board: Dimensions 40 x 40 mm (1600 mm² in one side)
 Copper (Cu) traces occupy 50% of the board area
 In top and back faces
 Package heat-sink is tied to the copper traces
 (Board of SOT-26 is used.)
- Material: Glass Epoxy (FR-4)
- Thickness: 1.6 mm
- Through-hole: 4 x 0.8 Diameter



Evaluation Board (Unit: mm)

2. Power Dissipation vs. Ambient temperature

Board Mount ($T_j \text{ max} = 125$)

Ambient Temperature ()	Power Dissipation Pd (mW)	Thermal Resistance (/W)
25	600	166.67
85	240	

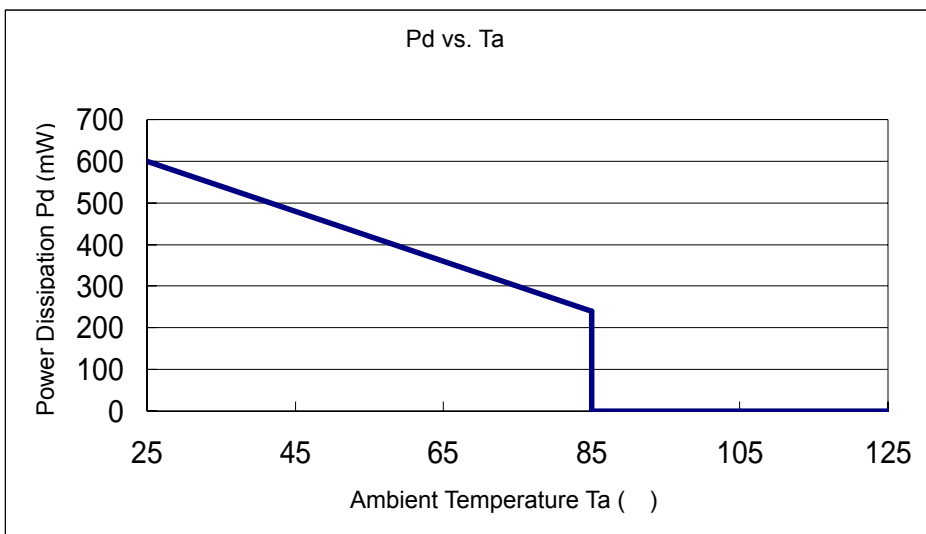

PACKAGING INFORMATION (Continued)

SOT-89-5 Power Dissipation

Power dissipation data for the SOT-89-5 is shown in this page.

The value of power dissipation varies with the mount board conditions.

Please use this data as one of reference data taken in the described condition.

1. Measurement Condition (Reference data)

Condition:	Mount on a board
Ambient:	Natural convection
Soldering:	Lead (Pb) free
Board:	Dimensions 40 x 40 mm (1600 mm ² in one side) Copper (Cu) traces occupy 50% of the board area In top and back faces Package heat-sink is tied to the copper traces
Material:	Glass Epoxy (FR-4)
Thickness:	1.6 mm
Through-hole:	5 x 0.8 Diameter



Evaluation Board (Unit: mm)

2. Power Dissipation vs. Ambient temperature

Board Mount ($T_j \text{ max} = 125$)

Ambient Temperature ()	Power Dissipation Pd (mW)	Thermal Resistance (/W)
25	1300	76.92
85	520	



PACKAGING INFORMATION (Continued)

USP-6B Power Dissipation

Power dissipation data for the USP-6B is shown in this page.
 The value of power dissipation varies with the mount board conditions.
 Please use this data as one of reference data taken in the described condition.

1. Measurement Condition (Reference data)

- Condition: Mount on a board
- Ambient: Natural convection
- Soldering: Lead (Pb) free
- Board: Dimensions 40 x 40 mm (1600 mm² in one side)
 Copper (Cu) traces occupy 50% of the board area
 In top and back faces
 Package heat-sink is tied to the copper traces
- Material: Glass Epoxy (FR-4)
- Thickness: 1.6 mm
- Through-hole: 4 x 0.8 Diameter

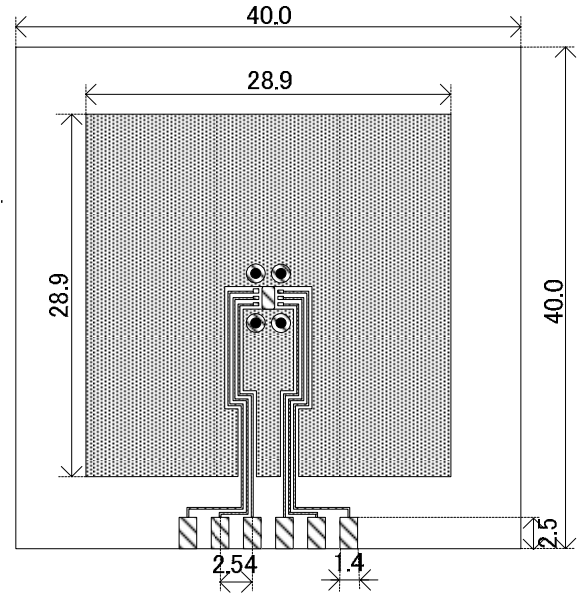

Evaluation Board (Unit: mm)

2. Power Dissipation vs. Ambient temperature

Board Mount ($T_j \text{ max} = 125$)

Ambient Temperature ()	Power Dissipation Pd (mW)	Thermal Resistance (/W)
25	1000	100.00
85	400	



MARKING RULE

SOT-25



SOT-25
(TOP VIEW)

represents product series

MARK	PRODUCT SERIES
0	XC6210xxxxxx

represents CE function

MARK				PRODUCT SERIES
OUTPUT VOLTAGE= 0.80~3.00V	OUTPUT VOLTAGE= 3.10~5.00V	OUTPUT VOLTAGE= 0.85~3.05V	OUTPUT VOLTAGE= 3.15~4.95V	
V	A	E	L	XC6210Axxxxx
X	B	F	M	XC6210Bxxxxx
Y	C	H	N	XC6210Cxxxxx
Z	D	K	P	XC6210Dxxxxx

SOT-89-5



SOT-89-5
(TOP VIEW)

represents output voltage

MARK	OUTPUT VOLTAGE (V)				MARK	OUTPUT VOLTAGE (V)			
0	-	3.10	-	3.15	F	1.60	4.60	1.65	4.65
1	-	3.20	-	3.25	H	1.70	4.70	1.75	4.75
2	-	3.30	-	3.35	K	1.80	4.80	1.85	4.85
3	-	3.40	-	3.45	L	1.90	4.90	1.95	4.95
4	-	3.50	-	3.55	M	2.00	5.00	2.05	-
5	-	3.60	-	3.65	N	2.10	-	2.15	-
6	-	3.70	-	3.75	P	2.20	-	2.25	-
7	0.80	3.80	0.85	3.85	R	2.30	-	2.35	-
8	0.90	3.90	0.95	3.95	S	2.40	-	2.45	-
9	1.00	4.00	1.05	4.05	T	2.50	-	2.55	-
A	1.10	4.10	1.15	4.15	U	2.60	-	2.65	-
B	1.20	4.20	1.25	4.25	V	2.70	-	2.75	-
C	1.30	4.30	1.35	4.35	X	2.80	-	2.85	-
D	1.40	4.40	1.45	4.45	Y	2.90	-	2.95	-
E	1.50	4.50	1.55	4.55	Z	3.00	-	3.05	-

represents production lot number

0 to 9, A to Z reverse character 0 to 9, A to Z repeated (G, I, J, O, Q, W excluded)

MARKING RULE (Continued)

USP-6B

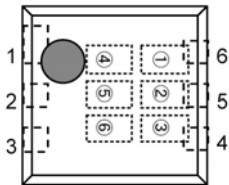

USP-6B
(TOP VIEW)

represents product series

MARK		PRODUCT SERIES
1	0	

represents CE Function

MARK	TYPE	PRODUCT SERIES
A	CE High Active with pull-down resistor	XC6210AxxxDx
B	CE High Active with no pull-down resistor	XC6210BxxxDx
C	CE Low Active with pull-up resistor	XC6210CxxxDx
D	CE Low Active with no pull-up resistor	XC6210DxxxDx

represents the integer number of output voltage
ex.)

MARK	VOLTAGE (V)	PRODUCT SERIES
3	3.x	XC6210x3xxDx
5	5.x	XC6210x5xxDx

represents the decimal point of output voltage

MARK	VOLTAGE (V)	PRODUCT SERIES	MARK	VOLTAGE (V)	PRODUCT SERIES
0	x.00	XC6210xx02Dx	A	x.05	XC6210xx0ADx
1	x.10	XC6210xx12Dx	B	x.15	XC6210xx1ADx
2	x.20	XC6210xx22Dx	C	x.25	XC6210xx2ADx
3	x.30	XC6210xx32Dx	D	x.35	XC6210xx3ADx
4	x.40	XC6210xx42Dx	E	x.45	XC6210xx4ADx
5	x.50	XC6210xx52Dx	F	x.55	XC6210xx5ADx
6	x.60	XC6210xx62Dx	H	x.65	XC6210xx6ADx
7	x.70	XC6210xx72Dx	K	x.75	XC6210xx7ADx
8	x.80	XC6210xx82Dx	L	x.85	XC6210xx8ADx
9	x.90	XC6210xx92Dx	M	x.95	XC6210xx9ADx



represents production lot number
0 to 9, A to Z repeated (G, I, J, O, Q, W, excluded)
Note: No character inversion used.

1. The products and product specifications contained herein are subject to change without notice to improve performance characteristics. Consult us, or our representatives before use, to confirm that the information in this datasheet is up to date.
2. We assume no responsibility for any infringement of patents, patent rights, or other rights arising from the use of any information and circuitry in this datasheet.
3. Please ensure suitable shipping controls (including fail-safe designs and aging protection) are in force for equipment employing products listed in this datasheet.
4. The products in this datasheet are not developed, designed, or approved for use with such equipment whose failure or malfunction can be reasonably expected to directly endanger the life of, or cause significant injury to, the user.
(e.g. Atomic energy; aerospace; transport; combustion and associated safety equipment thereof.)
5. Please use the products listed in this datasheet within the specified ranges.
Should you wish to use the products under conditions exceeding the specifications, please consult us or our representatives.
6. We assume no responsibility for damage or loss due to abnormal use.
7. All rights reserved. No part of this datasheet may be copied or reproduced without the prior permission of TOREX SEMICONDUCTOR LTD.

TOREX SEMICONDUCTOR LTD.

Looking for pricing, stock, or lifecycle information?

Click below to explore more details on WIN SOURCE:

-  [View XC6210B322MR on WIN SOURCE](#)
-  [Torex Semiconductor Ltd Information](#)

Optimize Your Supply Chain with WIN SOURCE Solutions

-  Global Sourcing Solution
-  Obsolete Management
-  Cost Control Management
-  Shortage Management
-  Alternative Solution
-  Excess Inventory Management