



**THE DATASHEET OF  
XC6213B122GR**



## 0.8 $\mu$ A Low Power Consumption Voltage Regulator with ON/OFF Switch

### ■ GENERAL DESCRIPTION

The XC6215 series are highly precise, low noise, positive voltage LDO regulators manufactured using CMOS processes. The series achieves very low supply current, 0.8  $\mu$  A (TYP.) and consists of a reference voltage source, an error amplifier, a current foldback circuit, and a phase compensation circuit plus a driver transistor.

Ultra small packages USP-3, USP-4, USPN-4, USP-6B06 and SSOT-24, and small package SOT-25 packages make high density mounting possible. Therefore, the series is ideal for applications where high density mounting is required such as in mobile phones.

Output voltage is selectable in 0.1V increments within a range of 0.9V ~ 5.0V by laser trimming

The series is also compatible with low ESR ceramic capacitors, which give added output stability.

The current limiter's foldback circuit also operates as a short protect for the output current limiter and the output pin.

Furthermore, the CE function allows the output of the regulator to be turned off, resulting in greatly reduced power consumption.

### ■ APPLICATIONS

- Smart phones / Mobile phones
- Portable game consoles
- Digital still cameras / Camcorders
- Digital audio equipments
- Mobile devices / terminals

### ■ FEATURES

- Maximum Output Current** : 200mA (300mA Limit, TYP.)  
@  $V_{OUT}=3.0V$ ,  $V_{IN}=4.0V$
- Dropout Voltage** : 320mV @  $I_{OUT} = 100mA$   
@  $V_{OUT} = 3.0V$
- Operating Input Voltage** : 1.5V ~ 6.0V
- Output Voltage Range** : 0.9V ~ 5.0V (0.1V Increments)
- Highly Accurate** : Set voltage accuracy  $\pm 2\%$   
( $1.5V < V_{OUT}(T) \leq 5.0V$ )  
Set voltage accuracy  $\pm 30mV$   
( $0.9V \leq V_{OUT}(T) \leq 1.5V$ )
- Low Power Consumption** : 0.8  $\mu$  A (TYP.)
- Stand-by Current** : Less than 0.1  $\mu$  A
- Operating Temperature Range** : - 40°C ~ 85°C
- Low ESR Capacitor Compatible** : Ceramic capacitor
- Current Limiter Circuit Built-In**
- Packages** : USP-4  
SSOT-24  
USP-3 (For the XC6215P series only)  
SOT-25  
USPN-4  
USP-6B06
- Environmentally Friendly** : EU RoHS Compliant, Pb Free

### ■ TYPICAL APPLICATION CIRCUIT

- USP-4, SSOT-24, SOT-25, USPN-4, USP-6B06 packages  
(For the USP-3 package, with no CE pin)



### ■ TYPICAL PERFORMANCE CHARACTERISTICS

- Supply Current vs. Input Voltage  
XC6215x302



## PIN CONFIGURATION



\* For mounting intensity and heat dissipation, please refer to recommended mounting pattern and recommended metal mask when soldering the pad of USP-4 and USP-6B06. Mounting should be electrically isolated or connected to the VSS (No.2) pin.



## PIN ASSIGNMENT

PIN NUMBER						PIN NAME	FUNCTIONS
USPN-4	USP-3	USP-4	SSOT-24	SOT-25	USP-6B06		
4	1	4	4	1	6	VIN	Power Supply
2	3	2	2	2	2	VSS	Ground
3	-	3	1	3	5	CE	ON / Off Switch
1	2	1	3	5	1	VOUT	Output
-	-	-	-	4	3,4	NC	No Connection

## ■ PRODUCT CLASSIFICATION

### ● Ordering Information

XC6215①②③④⑤⑥-⑦<sup>(\*)</sup>

DESIGNATOR	ITEM	SYMBOL	DESCRIPTION
①	Type of Regulator	B	CE logic = High active with no pull-down resistor
		P	3 pin regulator with no CE pin (USP-3 only)
②③	Output Voltage	09 ~ 50	0.9 V ~ 5.0V, 0.1V step e.g. V <sub>OUT</sub> =3.0V⇒②=3, ③=0
④	Output Voltage Accuracy	2	± 2 % accuracy e.g. V <sub>OUT</sub> =3.0V⇒②=3, ③=0, ④=2
⑤⑥-⑦	Packages (Order Unit)	GR-G	USP-4 (3,000pcs/Reel)
		NR	SSOT-24 (3,000pcs/Reel)
		NR-G	SSOT-24 (3,000pcs/Reel)
		MR	SOT-25 (3,000pcs/Reel)
		MR-G	SOT-25 (3,000pcs/Reel)
		HR	USP-3 (for the XC6215P series only) (3,000pcs/Reel)
		HR-G	USP-3 (for the XC6215P series only) (3,000pcs/Reel)
		7R-G	USPN-4 (5,000pcs/Reel)
8R-G	USP-6B06 (5,000pcs/Reel)		

(\*) The "-G" suffix denotes Halogen and Antimony free as well as being fully EU RoHS compliant.

## ■ PIN FUNCTION ASSIGNMENT

XC6215 Series (Type B)

CE	IC OPERATION
H	Operation ON
L	Operation OFF

\*CE pin should not be left open.

## ■ BLOCK DIAGRAMS

### ● XC6215B Series



### ● XC6215P Series



\* Diodes shown in the above circuit are ESD protection diodes and parasitic diodes

## ■ ABSOLUTE MAXIMUM RATINGS

PARAMETER	SYMBOL	RATINGS	UNITS		
Input Voltage	V <sub>IN</sub>	- 0.3 ~ + 7.0	V		
Output Current	I <sub>OUT</sub>	500 <sup>(*)1</sup>	mA		
Output Voltage	V <sub>OUT</sub>	V <sub>SS</sub> - 0.3 ~ V <sub>IN</sub> + 0.3	V		
CE Input Voltage <sup>(*)2</sup>	V <sub>CE</sub>	V <sub>SS</sub> - 0.3 ~ + 7.0	V		
Power Dissipation	SOT-25	Pd	250	mW	
			600(PCB mounted) <sup>(*)3</sup>		
			SSOT-24		150
			500(PCB mounted) <sup>(*)3</sup>		
			USP-4		120
			1000(PCB mounted) <sup>(*)3</sup>		
			USP-3		120
USPN-4	100				
USP-6B06	600(PCB mounted) <sup>(*)3</sup>				
		900(PCB mounted) <sup>(*)3</sup>			
Operating Ambient Temperature	T <sub>opr</sub>	- 40 ~ + 85	°C		
Storage Temperature	T <sub>stg</sub>	- 55 ~ +125	°C		

Note:

<sup>(\*)1</sup>: I<sub>OUT</sub> = Pd / (V<sub>IN</sub> - V<sub>OUT</sub>)

<sup>(\*)2</sup>: Except for the XC6215P series

<sup>(\*)3</sup>: The power dissipation figure shown is PCB mounted. Please refer to pages 34 to 38 for details

## ■ ELECTRICAL CHARACTERISTICS

● XC6215B Series

Ta = 25°C

PARAMETER	SYMBOL	CONDITIONS	MIN.	TYP.	MAX.	UNIT.	CIRCUIT
Output Voltage (*2)	V <sub>OUT(E)</sub>	V <sub>IN</sub> =V <sub>C</sub> E=V <sub>OUT(T)</sub> (*1) + 1.0V, I <sub>OUT</sub> =1mA	E-0(*6)			V	①
Maximum Output Current	I <sub>OUTMAX</sub>	V <sub>IN</sub> =V <sub>C</sub> E=V <sub>OUT(T)</sub> + 1.0V V <sub>OUT(T)</sub> =0.9V	50	70	-	mA	①
		V <sub>IN</sub> =V <sub>C</sub> E=V <sub>OUT(T)</sub> + 1.0V V <sub>OUT(T)</sub> =1.0V ~ 1.1V	60	80	-		
		V <sub>IN</sub> =V <sub>C</sub> E=V <sub>OUT(T)</sub> + 1.0V V V <sub>OUT(T)</sub> =1.2V ~ 1.3V	80	110	-		
		V <sub>IN</sub> =V <sub>C</sub> E=V <sub>OUT(T)</sub> + 1.0V V <sub>OUT(T)</sub> =1.4V ~ 1.6V	100	140	-		
		V <sub>IN</sub> =V <sub>C</sub> E=V <sub>OUT(T)</sub> + 1.0V V <sub>OUT(T)</sub> =1.7V ~ 2.2V	120	150	-		
		V <sub>IN</sub> =V <sub>C</sub> E=V <sub>OUT(T)</sub> + 1.0V V <sub>OUT(T)</sub> =2.3V ~ 2.9V	150	195	-		
		V <sub>IN</sub> =V <sub>C</sub> E=V <sub>OUT(T)</sub> + 1.0V V <sub>OUT(T)</sub> ≥3.0V	200	300	-		
Load Regulation	ΔV <sub>OUT</sub>	V <sub>IN</sub> =V <sub>C</sub> E=V <sub>OUT(T)</sub> + 1.0V V <sub>OUT(T)</sub> =0.9V 1mA ≤ I <sub>OUT</sub> ≤ 50mA	-	15	70	mV	①
		V <sub>IN</sub> =V <sub>C</sub> E=V <sub>OUT(T)</sub> + 1.0V V <sub>OUT(T)</sub> = 1.0V ~ 1.1V 1mA ≤ I <sub>OUT</sub> ≤ 60mA					
		V <sub>IN</sub> =V <sub>C</sub> E=V <sub>OUT(T)</sub> + 1.0V V <sub>OUT(T)</sub> =1.2V~1.3V 1mA ≤ I <sub>OUT</sub> ≤ 80mA					
		V <sub>IN</sub> =V <sub>C</sub> E=V <sub>OUT(T)</sub> + 1.0V V <sub>OUT(T)</sub> ≥ 1.4V 1mA ≤ I <sub>OUT</sub> ≤ 100mA					
Dropout Voltage (*3)	V <sub>dif</sub>	V <sub>C</sub> E=V <sub>IN</sub> , V <sub>OUT(T)</sub> =0.9V I <sub>OUT</sub> =50mA	E-1(*6)			mV	①
		V <sub>C</sub> E=V <sub>IN</sub> , V <sub>OUT(T)</sub> =1.0V ~ 1.1V I <sub>OUT</sub> =60mA					
		V <sub>C</sub> E=V <sub>IN</sub> , V <sub>OUT(T)</sub> =1.2V ~ 1.3V I <sub>OUT</sub> =80mA					
		V <sub>C</sub> E=V <sub>IN</sub> , V <sub>OUT(T)</sub> ≥1.4V I <sub>OUT</sub> =100mA					
Supply Current	I <sub>DD</sub>	V <sub>IN</sub> =V <sub>C</sub> E=V <sub>OUT(T)</sub> + 1.0V V <sub>OUT(T)</sub> ≤3.9V	-	0.8	1.5	μA	②
		V <sub>IN</sub> =V <sub>C</sub> E=V <sub>OUT(T)</sub> + 1.0V V <sub>OUT(T)</sub> ≥4.0V	-	1.0	1.8		
Stand-by Current	I <sub>stby</sub>	V <sub>IN</sub> =V <sub>OUT(T)</sub> + 1.0V, V <sub>C</sub> E=V <sub>SS</sub>	-	0.01	0.10	μA	②

## ELECTRICAL CHARACTERISTICS (Continued)

●XC6215B Series (Continued)

Ta = 25°C

PARAMETER	SYMBOL	CONDITIONS	MIN.	TYP.	MAX.	UNIT.	CIRCUIT
Line Regulation	$\Delta V_{OUT}/(\Delta V_{IN} \cdot V_{OUT})$	$V_{OUT(T)}=0.9V, V_{CE}=V_{IN}$ $1.5V \leq V_{IN} \leq 6.0V$ $I_{OUT}=1mA$	-	0.05	0.15	%V	①
		$V_{OUT(T)}=1.0V \sim 1.2V, V_{CE}=V_{IN}$ $V_{OUT(T)}+0.5V \leq V_{IN} \leq 6.0V$ $I_{OUT}=1mA$					
		$V_{OUT(T)} \geq 1.3V, V_{CE}=V_{IN}$ $V_{OUT(T)}+0.5V \leq V_{IN} \leq 6.0V$ $I_{OUT}=30mA$					
Input Voltage	$V_{IN}$	-	1.5	-	6.0	V	-
Output Voltage Temperature Characteristics	$\Delta V_{OUT}/(\Delta T_{opr} \cdot V_{OUT})$	$V_{IN}=V_{CE}=V_{OUT(T)}+1.0V, I_{OUT}=30mA$ $-40^{\circ}C \leq T_{opr} \leq 85^{\circ}C$	-	$\pm 100$	-	ppm /°C	①
Current Limit	$I_{lim}$	$V_{OUT}=V_{OUT(E)} \times 0.95$ $V_{OUT(T)}=0.9V$ $V_{IN}=V_{CE}=V_{OUT(T)}+2.0V$	100	300	-	mA	①
		$V_{OUT}=V_{OUT(E)} \times 0.95$ $V_{OUT(T)}=1.0V \sim 1.1V$ $V_{IN}=V_{CE}=V_{OUT(T)}+2.0V$	120	300	-		
		$V_{OUT}=V_{OUT(E)} \times 0.95$ $V_{OUT(T)}=1.2V \sim 1.3V$ $V_{IN}=V_{CE}=V_{OUT(T)}+2.0V$	160	300	-		
		$V_{OUT}=V_{OUT(E)} \times 0.95$ $V_{OUT(T)}=1.4V \sim 2.9V$ $V_{IN}=V_{CE}=V_{OUT(T)}+2.0V$	200	300	-		
		$V_{OUT}=V_{OUT(E)} \times 0.95$ $V_{OUT(T)} \geq 3.0V$ $V_{IN}=V_{CE}=V_{OUT(T)}+1.0V$	200	300	-		
Short Circuit Current	$I_{short}$	$V_{IN}=V_{CE}=V_{OUT(T)}+1.0V,$ $V_{OUT}=0V$	-	50	-	mA	①
CE 'H' Level Voltage	$V_{CEH}$	$V_{IN}=V_{OUT(T)}+1.0V$	1.0	-	6.0	V	①
CE 'L' Level Voltage	$V_{CEL}$	$V_{IN}=V_{OUT(T)}+1.0V$	-	-	0.3		
CE 'H' Level Current	$I_{CEH}$	$V_{IN}=V_{CE}=V_{OUT(T)}+1.0V$	-0.1	-	0.1	$\mu A$	②
CE 'L' Level Current	$I_{CEL}$	$V_{IN}=V_{OUT(T)}+1.0V, V_{CE}=V_{SS}$	-0.1	-	0.1		

NOTE:

- \*1:  $V_{OUT(T)}$ : Fixed output voltage
- \*2:  $V_{OUT(E)}$  = Effective output voltage  
(i.e. the output voltage when "V<sub>OUT(T)</sub> + 1.0V" is provided at the V<sub>IN</sub> pin while maintaining a certain I<sub>OUT</sub> value).
- \*3:  $V_{dif} = \{ V_{IN1}^{(*)} - V_{OUT1}^{(*)} \}$
- \*4:  $V_{IN1}$  = The input voltage when  $V_{OUT1}$  appears as input voltage is gradually decreased.
- \*5:  $V_{OUT1}$  = A voltage equal to 98% of the output voltage whenever an amply stabilized I<sub>OUT</sub> {  $V_{OUT(T)} + 1.0V$  } is input.
- \*6: Refer to "VOLTAGE CHART".

■ **ELECTRICAL CHARACTERISTICS (Continued)**

● XC6215P Series

Ta = 25°C

PARAMETER	SYMBOL	CONDITIONS	MIN.	TYP.	MAX.	UNIT.	CIRCUIT
Output Voltage (*2)	V <sub>OUT(E)</sub>	V <sub>IN</sub> =V <sub>OUT(T)</sub> (*1) + 1.0V, I <sub>OUT</sub> =1mA	E-0 (*6)			V	①
Maximum Output Current	I <sub>OUTMAX</sub>	V <sub>IN</sub> =V <sub>OUT(T)</sub> + 1.0V V <sub>OUT(T)</sub> =0.9V	50	70	-	mA	①
		V <sub>IN</sub> =V <sub>OUT(T)</sub> + 1.0V V <sub>OUT(T)</sub> =1.0V ~ 1.1V	60	80	-		
		V <sub>IN</sub> =V <sub>OUT(T)</sub> + 1.0V V <sub>OUT(T)</sub> =1.2V ~ 1.3V	80	110	-		
		V <sub>IN</sub> =V <sub>OUT(T)</sub> + 1.0V V <sub>OUT(T)</sub> =1.4V ~ 1.6V	100	140	-		
		V <sub>IN</sub> =V <sub>OUT(T)</sub> + 1.0V V <sub>OUT(T)</sub> =1.7V ~ 2.2V	120	150	-		
		V <sub>IN</sub> =V <sub>OUT(T)</sub> + 1.0V V <sub>OUT(T)</sub> =2.3V ~ 2.9V	150	195	-		
		V <sub>IN</sub> =V <sub>OUT(T)</sub> + 1.0V V <sub>OUT(T)</sub> ≥3.0V	200	300	-		
Load Regulation	ΔV <sub>OUT</sub>	V <sub>IN</sub> =V <sub>OUT(T)</sub> + 1.0V V <sub>OUT(T)</sub> =0.9V 1mA ≤ I <sub>OUT</sub> ≤ 50mA	-	15	70	mV	①
		V <sub>IN</sub> =V <sub>OUT(T)</sub> + 1.0V V <sub>OUT(T)</sub> = 1.0V~1.1V 1mA ≤ I <sub>OUT</sub> ≤ 60mA					
		V <sub>IN</sub> =V <sub>OUT(T)</sub> + 1.0V V <sub>OUT(T)</sub> =1.2V~1.3V 1mA ≤ I <sub>OUT</sub> ≤ 80mA					
		V <sub>IN</sub> =V <sub>OUT(T)</sub> + 1.0V V <sub>OUT(T)</sub> ≥1.4V 1mA ≤ I <sub>OUT</sub> ≤ 100mA					
Dropout Voltage (*3)	V <sub>dif</sub>	V <sub>OUT(T)</sub> =0.9V I <sub>OUT</sub> =50mA	E-1 (*6)			mV	①
		V <sub>OUT(T)</sub> =1.0V ~ 1.1V I <sub>OUT</sub> =60mA					
		V <sub>OUT(T)</sub> =1.2V ~ 1.3V I <sub>OUT</sub> =80mA					
		V <sub>OUT(T)</sub> ≥1.4V I <sub>OUT</sub> =100mA					
Supply Current	I <sub>DD</sub>	V <sub>IN</sub> =V <sub>OUT(T)</sub> =1.0V V <sub>OUT(T)</sub> ≤3.9V	-	0.8	1.5	μA	②
		V <sub>IN</sub> = V <sub>OUT(T)</sub> +1.0V V <sub>OUT(T)</sub> ≥4.0V	-	1.0	1.8		

## ■ ELECTRICAL CHARACTERISTICS (Continued)

● XC6215P Series (Continued)

Ta = 25°C

PARAMETER	SYMBOL	CONDITIONS	MIN.	TYP.	MAX.	UNIT.	CIRCUIT
Line Regulation	$\frac{\Delta V_{OUT}}{\Delta V_{IN} \cdot V_{OUT}}$	$V_{OUT(T)}=0.9V$ $1.5V \leq V_{IN} \leq 6.0V$ $I_{OUT}=1mA$	-	0.05	0.15	%V	①
		$V_{OUT(T)}=1.0V \sim 1.2V$ $V_{OUT(T)}+0.5V \leq V_{IN} \leq 6.0V$ $I_{OUT}=1mA$					
		$V_{OUT(T)} \geq 1.3V$ $V_{OUT(T)}+0.5V \leq V_{IN} \leq 6.0V$ $I_{OUT}=30mA$					
Input Voltage	$V_{IN}$	-	1.5	-	6.0	V	-
Output Voltage Temperature Characteristics	$\frac{\Delta V_{OUT}}{\Delta T_{opr} \cdot V_{OUT}}$	$V_{IN}=V_{OUT(T)}+1.0V, I_{OUT}=30mA$ $-40^{\circ}C \leq T_{opr} \leq 85^{\circ}C$	-	$\pm 100$	-	ppm /°C	①
Current Limit	$I_{lim}$	$V_{OUT}=V_{OUT(E)} \times 0.95$ $V_{OUT(T)}=0.9V$ $V_{IN}=V_{OUT(T)}+2.0V$	100	300	-	mA	①
		$V_{OUT}=V_{OUT(E)} \times 0.95$ $V_{OUT(T)}=1.0V \sim 1.1V$ $V_{IN}=V_{OUT(T)}+2.0V$	120	300	-		
		$V_{OUT}=V_{OUT(E)} \times 0.95$ $V_{OUT(T)}=1.2V \sim 1.3V$ $V_{IN}=V_{OUT(T)}+2.0V$	160	300	-		
		$V_{OUT}=V_{OUT(E)} \times 0.95$ $V_{OUT(T)}=1.4V \sim 2.9V$ $V_{IN}=V_{OUT(T)}+2.0V$	200	300	-		
		$V_{OUT}=V_{OUT(E)} \times 0.95$ $V_{OUT(T)} \geq 3.0V$ $V_{IN}=V_{OUT(T)}+1.0V$	200	300	-		
Short Circuit Current	$I_{short}$	$V_{IN}=V_{OUT(T)}+1.0V, V_{OUT}=0V$	-	50	-	mA	①

NOTE:

\*1:  $V_{OUT(T)}$ : Fixed output voltage

\*2:  $V_{OUT(E)}$  = Effective output voltage

(i.e. the output voltage when " $V_{OUT(T)} + 1.0V$ " is provided at the  $V_{IN}$  pin while maintaining a certain  $I_{OUT}$  value).

\*3:  $V_{dif} = \{ V_{IN1}^{(*)4} - V_{OUT1}^{(*)5} \}$

\*4:  $V_{IN1}$  = The input voltage when  $V_{OUT1}$  appears as input voltage is gradually decreased.

\*5:  $V_{OUT1}$  = A voltage equal to 98% of the output voltage whenever an amply stabilized  $I_{OUT} \{ V_{OUT(T)} + 1.0V \}$  is input.

\*6: Refer to "VOLTAGE CHART".

## ■ VOLTAGE CHART

### ● Dropout Voltage Chart

Ta = 25°C

SETTING OUTPUT VOLTAGE	E-0		E-1	
	OUTPUT VOLTAGE (V)		DROPOUT VOLTAGE (mV)	
VOUT(T)	VOUT		Vdif	
	MIN.	MAX.	TYP.	MAX.
0.9	0.870	0.930	870	1000
1.0	0.970	1.030	860	1000
1.1	1.070	1.130	780	950
1.2	1.170	1.230	800	1000
1.3	1.270	1.330	720	900
1.4	1.370	1.430	750	960
1.5	1.470	1.530	700	890
1.6	1.568	1.632	680	860
1.7	1.666	1.734	650	830
1.8	1.764	1.836	630	800
1.9	1.862	1.938	610	780
2.0	1.960	2.040	580	740
2.1	2.058	2.142	580	740
2.2	2.156	2.244	580	740
2.3	2.254	2.346	510	650
2.4	2.352	2.448	510	650
2.5	2.450	2.550	450	580
2.6	2.548	2.652	450	580
2.7	2.646	2.754	450	580
2.8	2.744	2.856	450	580
2.9	2.842	2.958	450	580
3.0	2.940	3.060	320	420
3.1	3.038	3.162	320	420
3.2	3.136	3.264	320	420
3.3	3.234	3.366	320	420
3.4	3.332	3.468	320	420
3.5	3.430	3.570	320	420
3.6	3.528	3.672	320	420
3.7	3.626	3.774	320	420
3.8	3.724	3.876	320	420
3.9	3.822	3.978	320	420
4.0	3.920	4.080	290	380
4.1	4.018	4.182	290	380
4.2	4.116	4.284	290	380
4.3	4.214	4.386	290	380
4.4	4.312	4.488	290	380
4.5	4.410	4.590	290	380
4.6	4.508	4.692	290	380
4.7	4.606	4.794	290	380
4.8	4.704	4.896	290	380
4.9	4.802	4.998	290	380
5.0	4.900	5.100	230	310

## TEST CIRCUITS

### ● Circuit ①



### ● Circuit ②



## ■ OPERATIONAL EXPLANATION

● XC6215B Series (As for the XC6215P Series, with no CE pin)

### <Output Voltage Control>

The voltage divided by resistors R1 & R2 is compared with the internal reference voltage by the error amplifier. The P-channel MOSFET, which is connected to the V<sub>OUT</sub> pin, is then driven by the subsequent output signal. The output voltage at the V<sub>OUT</sub> pin is controlled and stabilized by a system of negative feedback. The current limit circuit and short protect circuit operate in relation to the level of output current. Further, the IC's internal circuitry can be operated or shutdown via the CE pin's signal.

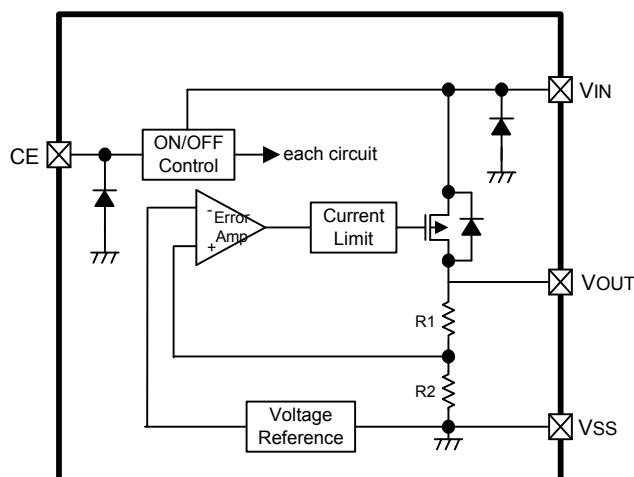

### <Short Protection Circuit>

The XC6215 series' regulator offers circuit protection by means of a built-in foldback circuit. When the load current reaches the current limit level, the fixed current limiter circuit operates and output voltage drops. As a result of this drop in output voltage, the foldback circuit operates, the output voltage drops further and output current decreases. When the output pin is shorted, a current of about 50mA flows.

### <CE Pin>

The IC's internal circuitry can be operated or shutdown via the signal from the CE pin with the XC6215B series. In shutdown mode, output at the V<sub>OUT</sub> pin will be pulled down to the V<sub>SS</sub> level via R1 & R2. Note that the XC6215 series' regulator is "High Active/No Pull-Down", operations will become unstable with the CE pin open. We suggest that you use this IC with either a V<sub>IN</sub> voltage or a V<sub>SS</sub> voltage input at the CE pin. If this IC is used with the correct specifications for the CE pin, the operational logic is fixed and the IC will operate normally. However, supply current may increase as a result of through current in the IC's internal circuitry.

## ■ NOTES ON USE

1. For temporary, transitional voltage drop or voltage rising phenomenon, the IC is liable to malfunction should the ratings be exceeded.
2. Where wiring impedance is high, operations may become unstable due to noise and/or phase lag depending on output current.
3. As for the XC6215 series, internally achieved phase compensation makes a stable operation of the IC possible even when there is no output capacitor (C<sub>L</sub>). In order to stabilize the V<sub>IN</sub>'s voltage level, we recommend that an input capacitor (C<sub>IN</sub>) of about 0.1 to 1.0 μF be connected between the V<sub>IN</sub> pin and the V<sub>SS</sub> pin. Moreover, during transient response, so as to prevent an undershoot or overshoot, we recommend that the output capacitor (C<sub>L</sub>) of about 0.1 to 1.0 μF be connected between the V<sub>OUT</sub> pin and the V<sub>SS</sub> pin. However, please wire the input capacitor (C<sub>IN</sub>) and the output capacitor (C<sub>L</sub>) as close to the IC as possible.
4. Torex places an importance on improving our products and its reliability. However, by any possibility, we would request user fail-safe design and post-aging treatment on system or equipment.

## TYPICAL PERFORMANCE CHARACTERISTICS

### (1) Output Voltage vs. Output Current



## ■ TYPICAL PERFORMANCE CHARACTERISTICS (Continued)

### (1) Output Voltage vs. Output Current (Continued)



### (2) Output Voltage vs. Input Voltage

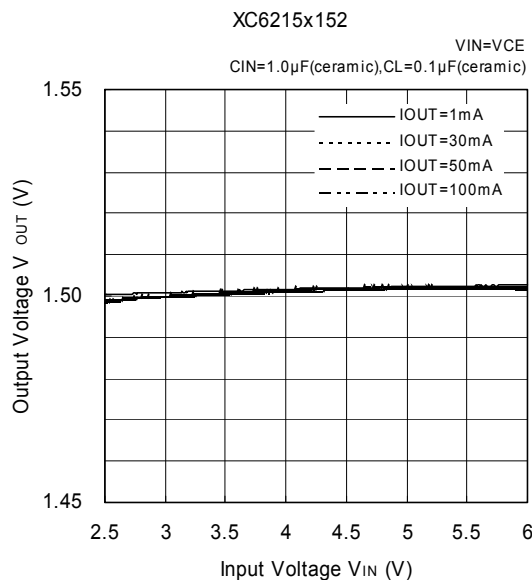

## TYPICAL PERFORMANCE CHARACTERISTICS (Continued)

### (2) Output Voltage vs. Input Voltage (Continued)

XC6215x302



XC6215x302



XC6215x502



XC6215x502



### (3) Dropout Voltage vs. Output Current

XC6215x092



XC6215x152



## ■ TYPICAL PERFORMANCE CHARACTERISTICS (Continued)

### (3) Dropout Voltage vs. Output Current (Continued)

XC6215x302



XC6215x502



### (4) Supply Current vs. Input Voltage

XC6215x092



XC6215x152



XC6215x302



XC6215x502

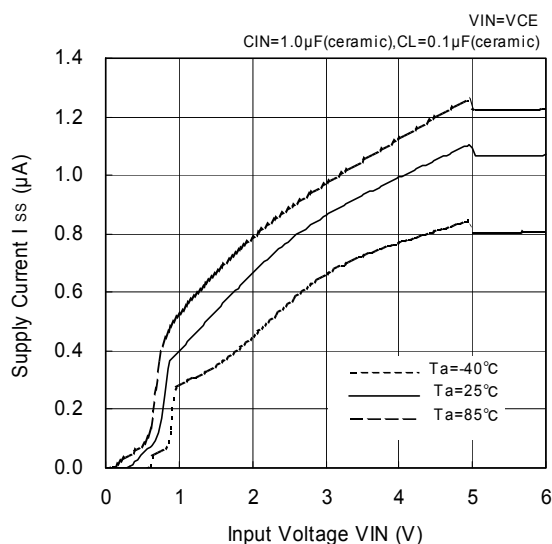

## TYPICAL PERFORMANCE CHARACTERISTICS (Continued)

### (5) Output Voltage vs. Ambient Temperature

XC6215x092



XC6215x152



XC6215x302

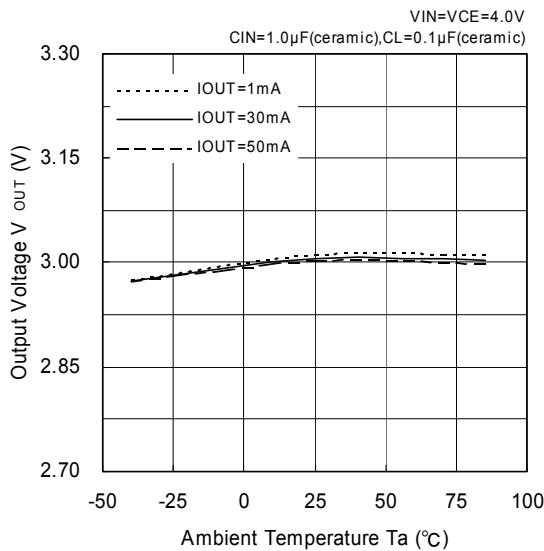

XC6215x502



### (6) Supply Current vs. Ambient Temperature

XC6215x092

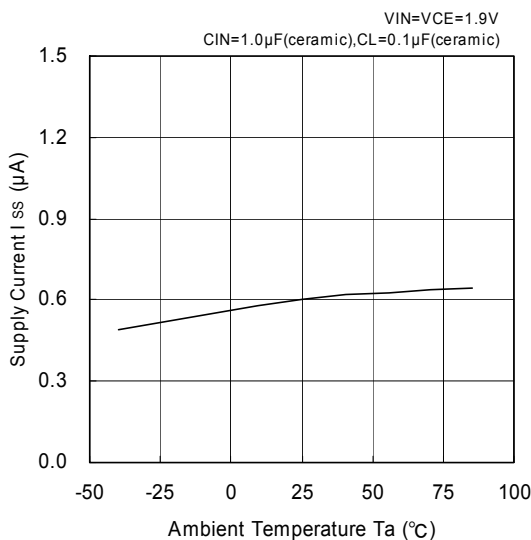

XC6215x152



## ■ TYPICAL PERFORMANCE CHARACTERISTICS (Continued)

### (6) Supply Current vs. Ambient Temperature (Continued)

XC6215x302



XC6215x502



### (7) CE Threshold Voltage vs. Ambient Temperature

XC6215x092



XC6215x152



XC6215x302



XC6215x502



## TYPICAL PERFORMANCE CHARACTERISTICS (Continued)

### (8) Input Transient Response



## ■ TYPICAL PERFORMANCE CHARACTERISTICS (Continued)

### (8) Input Transient Response (Continued)

XC6215x152

$t_r=t_f=5\mu\text{sec}$   $V_{IN}=V_{CE}$ ,  
 $I_{OUT}=1\text{mA}$ ,  $C_L=0.1\mu\text{F}$ (ceramic)



XC6215x152

$t_r=t_f=5\mu\text{sec}$ ,  $V_{IN}=V_{CE}$ ,  
 $I_{OUT}=1\text{mA}$ ,  $C_L=1.0\mu\text{F}$ (セラミック)



XC6215x152

$t_r=t_f=5\mu\text{sec}$   $V_{IN}=V_{CE}$ ,  
 $I_{OUT}=30\text{mA}$ ,  $C_L=0.1\mu\text{F}$ (ceramic)



XC6215x152

$t_r=t_f=5\mu\text{sec}$ ,  $V_{IN}=V_{CE}$ ,  
 $I_{OUT}=30\text{mA}$ ,  $C_L=1.0\mu\text{F}$ (ceramic)



XC6215x152

$t_r=t_f=5\mu\text{sec}$ ,  $V_{IN}=V_{CE}$ ,  
 $I_{OUT}=100\text{mA}$ ,  $C_L=0.1\mu\text{F}$ (ceramic)



XC6215x152

$t_r=t_f=5\mu\text{sec}$ ,  $V_{IN}=V_{CE}$ ,  
 $I_{OUT}=100\text{mA}$ ,  $C_L=1.0\mu\text{F}$ (ceramic)



## TYPICAL PERFORMANCE CHARACTERISTICS (Continued)

### (8) Input Transient Response (Continued)



## ■ TYPICAL PERFORMANCE CHARACTERISTICS (Continued)

### (8) Input Transient Response (Continued)



## TYPICAL PERFORMANCE CHARACTERISTICS (Continued)

### (9) Load Transient Response



## ■ TYPICAL PERFORMANCE CHARACTERISTICS (Continued)

### (9) Load Transient Response (Continued)



## TYPICAL PERFORMANCE CHARACTERISTICS (Continued)

### (9) Load Transient Response (Continued)



### (10) Rising Response Time

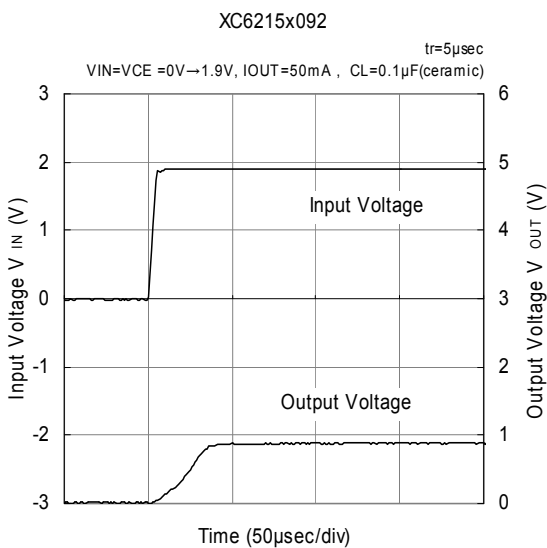
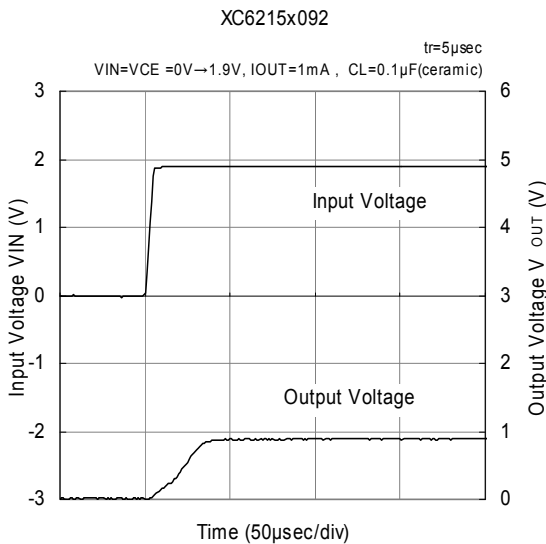

## ■ TYPICAL PERFORMANCE CHARACTERISTICS (Continued)

### (10) Rising Response Time (Continued)

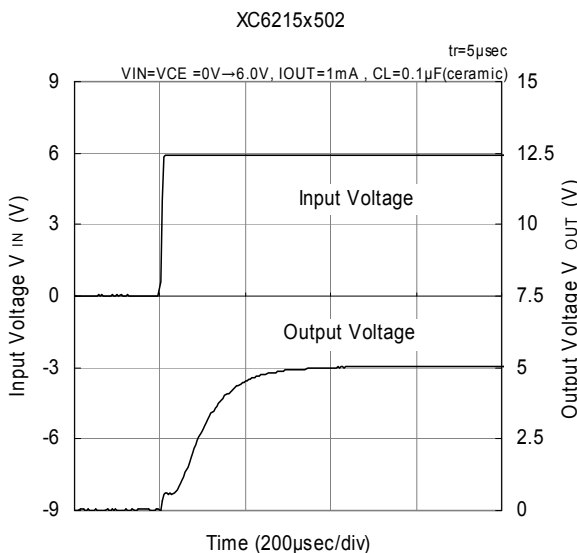
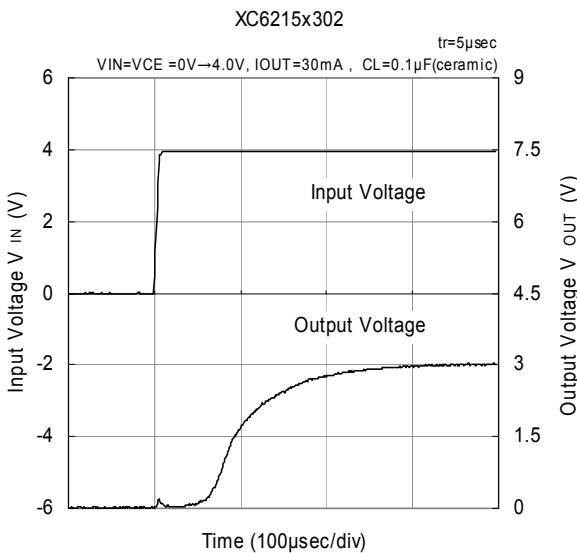
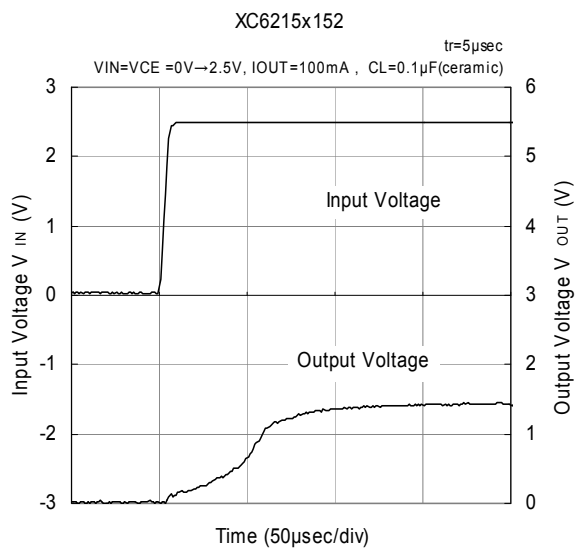

## TYPICAL PERFORMANCE CHARACTERISTICS (Continued)

### (10) Rising Response Time (Continued)



### (11) CE Rising Response Time (For XC6215B Type)



## ■ TYPICAL PERFORMANCE CHARACTERISTICS (Continued)

### (11) CE Rising Response Time (Continued)

XC6215B152



XC6215B152



XC6215B302



XC6215B302



XC6215B302



XC6215B502



## TYPICAL PERFORMANCE CHARACTERISTICS (Continued)

(11) CE Rising Response Time (For XC6215 Type)

XC6215B502



XC6215B502

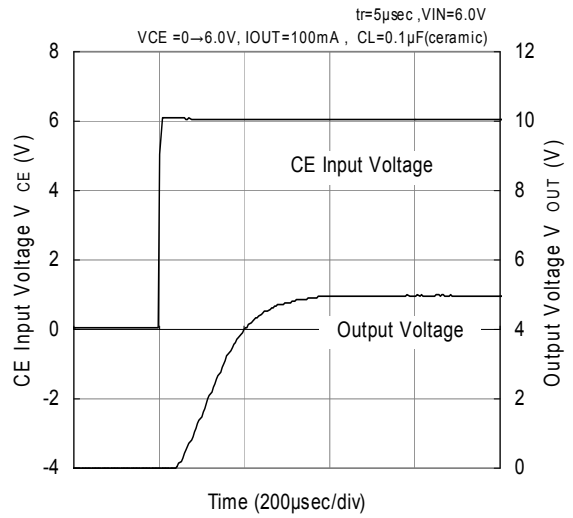

(12) Ripple Rejection Rate

XC6215x092



XC6215x152



XC6215x302



XC6215x502



**PACKAGING INFORMATION**

● USP-4



(Unit : mm)

Reference pattern Layout



Reference metal mask design



● USP-3



(Unit : mm)

Reference pattern Layout



Reference metal mask design



## PACKAGING INFORMATION (Continued)

### ● SOT-25



### ● SSOT-24



### ● USP-4



### Reference pattern Layout



### Reference metal mask design



■ PACKAGING INFORMATION (Continued)

● USP-6B06



Reference pattern Layout



Reference metal mask design



## MARKING RULE

### ●SSOT-24



① represents type of regulator and output voltage range

MARK	TYPE	OUTPUT VOLTAGE RANGE	PRODUCT SERIES
T	CE pin, High Active with no pull-down resistor built in	0.9V ~ 3.0V	XC6215Bxxxxx
U		3.1V ~ 5.0V	

② represents decimal point of output voltage

MARK	OUTPUT VOLTAGE (V)		MARK	OUTPUT VOLTAGE (V)			
0	-	3.1	-	F	1.6	4.6	-
1	-	3.2	-	H	1.7	4.7	-
2	-	3.3	-	K	1.8	4.8	-
3	-	3.4	-	L	1.9	4.9	-
4	-	3.5	-	M	2.0	5.0	-
5	-	3.6	-	N	2.1	-	-
6	-	3.7	-	P	2.2	-	-
7	-	3.8	-	R	2.3	-	-
8	0.9	3.9	-	S	2.4	-	-
9	1.0	4.0	-	T	2.5	-	-
A	1.1	4.1	-	U	2.6	-	-
B	1.2	4.2	-	V	2.7	-	-
C	1.3	4.3	-	X	2.8	-	-
D	1.4	4.4	-	Y	2.9	-	-
E	1.5	4.5	-	Z	3.0	-	-

③ represents production lot number  
0 to 9, A to Z repeated. (G, I, J, O, Q, W excluded)  
NOTE: No character inversion used.

### ●USP-4, USP-3



① represents product series

MARK	PRODUCT SERIES
E	XC6215xxxxxx

② represents type of regulator and output voltage range

MARK	TYPE	OUTPUT VOLTAGE RANGE	PRODUCT SERIES
T	CE pin, High Active with no pull-down resistor built in	0.9V ~ 3.0V	XC6215xxxxxx
U		3.1V ~ 5.0V	



③ represents output voltage

MARK	OUTPUT VOLTAGE (V)		MARK	OUTPUT VOLTAGE (V)			
0	-	3.1	-	F	1.6	4.6	-
1	-	3.2	-	H	1.7	4.7	-
2	-	3.3	-	K	1.8	4.8	-
3	-	3.4	-	L	1.9	4.9	-
4	-	3.5	-	M	2.0	5.0	-
5	-	3.6	-	N	2.1	-	-
6	-	3.7	-	P	2.2	-	-
7	-	3.8	-	R	2.3	-	-
8	0.9	3.9	-	S	2.4	-	-
9	1.0	4.0	-	T	2.5	-	-
A	1.1	4.1	-	U	2.6	-	-
B	1.2	4.2	-	V	2.7	-	-
C	1.3	4.3	-	X	2.8	-	-
D	1.4	4.4	-	Y	2.9	-	-
E	1.5	4.5	-	Z	3.0	-	-

④ represents production lot number  
0 to 9, A to Z repeated. (G, I, J, O, Q, W excluded)  
NOTE: No character inversion used.

## MARKING RULE (Continued)

### ● SOT-25



SOT-25  
(TOP VIEW)

### ● USPN-4



USPN-4  
(TOP VIEW)

### ● USP-6B06

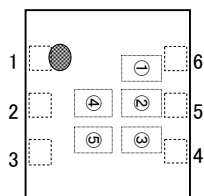

USP-6B06  
(TOP VIEW)

① represents product series

MARK	PRODUCT SERIES
E	XC6215xxxxxx

② represents type of regulators and output voltage range

MARK	TYPE	OUTPUT VOLTAGE RANGE	PRODUCT SERIES
T	CE pin, High Active with no pull-down resistor built in	0.9V~3.0V	XC6215xxxxxx
U		3.1V~5.0V	

③ represents output voltage

MARK	OUTPUT VOLTAGE (V)			MARK	OUTPUT VOLTAGE (V)		
0	-	3.1	-	F	1.6	4.6	-
1	-	3.2	-	H	1.7	4.7	-
2	-	3.3	-	K	1.8	4.8	-
3	-	3.4	-	L	1.9	4.9	-
4	-	3.5	-	M	2.0	5.0	-
5	-	3.6	-	N	2.1	-	-
6	-	3.7	-	P	2.2	-	-
7	-	3.8	-	R	2.3	-	-
8	0.9	3.9	-	S	2.4	-	-
9	1.0	4.0	-	T	2.5	-	-
A	1.1	4.1	-	U	2.6	-	-
B	1.2	4.2	-	V	2.7	-	-
C	1.3	4.3	-	X	2.8	-	-
D	1.4	4.4	-	Y	2.9	-	-
E	1.5	4.5	-	Z	3.0	-	-

④⑤ represents production lot number  
0 to 9, A to Z repeated. (G, I, J, O, Q, W excluded)  
NOTE: No character inversion used.

● SOT-25 Power Dissipation

Power dissipation data for the SOT-25 is shown in this page.  
The value of power dissipation varies with the mount board conditions.  
Please use this data as one of reference data taken in the described condition.

1. Measurement Condition (Reference data)

- Condition: Mount on a board
- Ambient: Natural convection
- Soldering: Lead (Pb) free
- Board: Dimensions 40 x 40 mm (1600 mm<sup>2</sup> in one side)  
Copper (Cu) traces occupy 50% of the board area  
In top and back faces  
Package heat-sink is tied to the copper traces  
(Board of SOT-26 is used.)
- Material: Glass Epoxy (FR-4)
- Thickness: 1.6 mm
- Through-hole: 4 x 0.8 Diameter



Evaluation Board (Unit: mm)

2. Power Dissipation vs. Ambient temperature

Board Mount (T<sub>j</sub> max = 125°C)

Ambient Temperature (°C)	Power Dissipation Pd (mW)	Thermal Resistance (°C/W)
25	600	166.67
85	240	



● SSOT-24 Power Dissipation

Power dissipation data for the SSOT-24 is shown in this page.  
The value of power dissipation varies with the mount board conditions.  
Please use this data as one of reference data taken in the described condition.

1. Measurement Condition (Reference data)

- Condition: Mount on a board
- Ambient: Natural convection
- Soldering: Lead (Pb) free
- Board: Dimensions 40 x 40 mm (1600 mm<sup>2</sup> in one side)  
Copper (Cu) traces occupy 50% of the board area  
In top and back faces  
Package heat-sink is tied to the copper traces
- Material: Glass Epoxy (FR-4)
- Thickness: 1.6 mm
- Through-hole: 4 x 0.8 Diameter



Evaluation Board (Unit: mm)

2. Power Dissipation vs. Ambient temperature

Board Mount (T<sub>j</sub> max = 125°C)

Ambient Temperature (°C)	Power Dissipation Pd (mW)	Thermal Resistance (°C/W)
25	500	200.00
85	200	

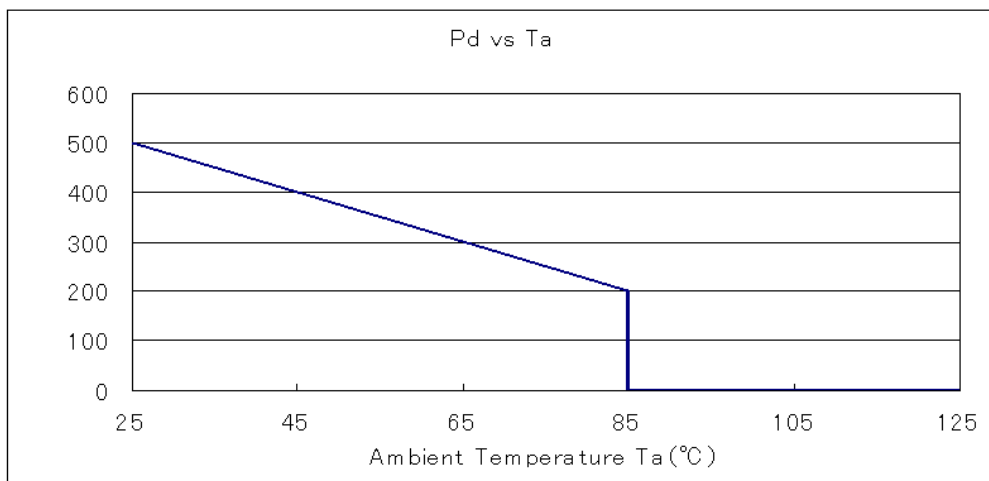

● USP-4 Power Dissipation

Power dissipation data for the USP-4 is shown in this page.  
 The value of power dissipation varies with the mount board conditions.  
 Please use this data as one of reference data taken in the described condition.

1. Measurement Condition (Reference data)

- Condition: Mount on a board
- Ambient: Natural convection
- Soldering: Lead (Pb) free
- Board: Dimensions 40 x 40 mm (1600 mm<sup>2</sup> in one side)  
 Copper (Cu) traces occupy 50% of the board area  
 In top and back faces  
 Package heat-sink is tied to the copper traces
- Material: Glass Epoxy (FR-4)
- Thickness: 1.6 mm
- Through-hole: 4 x 0.8 Diameter



Evaluation Board (Unit: mm)

2. Power Dissipation vs. Ambient temperature

Board Mount ( $T_j \text{ max} = 125^\circ\text{C}$ )

Ambient Temperature (°C)	Power Dissipation Pd (mW)	Thermal Resistance (°C/W)
25	1000	100.00
85	400	



● **USPN-4 Power Dissipation**

Power dissipation data for the USPN-4 is shown in this page.  
The value of power dissipation varies with the mount board conditions.  
Please use this data as one of reference data taken in the described condition.



Evaluation Board (Unit: mm)

1. Measurement Condition (Reference data)

- Condition: Mount on a board
- Ambient: Natural convection
- Soldering: Lead (Pb) free
- Board: Dimensions 40 x 40 mm (1600 mm<sup>2</sup> in one side)  
Copper (Cu) traces occupy 50% of the front and 50% of the back.  
The copper area is divided into four block, one block is 12.5% of total.  
The USPN-4 package has for terminals.  
Each terminal connects one copper block in the front and one in the back.

- Material: Glass Epoxy (FR-4)
- Thickness: 1.6 mm
- Through-hole: 4 x 0.8 Diameter

2. Power Dissipation vs. Ambient temperature

Board Mount (T<sub>j</sub> max = 125°C)

Ambient Temperature (°C)	Power Dissipation Pd (mW)	Thermal Resistance (°C/W)
25	600	166.67
85	240	



● USP-6B06 Power Dissipation

Power dissipation data for the USP-6B06 is shown in this page.  
 The value of power dissipation varies with the mount board conditions.  
 Please use this data as the reference data taken in the following condition.

1. Measurement Condition

- Condition: Mount on a board
- Ambient: Natural convection
- Soldering: Lead (Pb) free
- Board: Dimensions 40 x 40 mm (1600 mm<sup>2</sup> in one side)  
 Copper (Cu) traces occupy 50% of the board area  
 In top and back faces  
 Package heat-sink is tied to the copper traces
- Material: Glass Epoxy (FR-4)
- Thickness: 1.6 mm
- Through-hole: 4 x 0.8 Diameter



Evaluation Board (Unit: mm)

2. Power Dissipation vs. Ambient Temperature

Board Mount (T<sub>j</sub> max = 125°C)

Ambient Temperature (°C)	Power Dissipation Pd (mW)	Thermal Resistance (°C/W)
25	900	111.11
85	360	



1. The product and product specifications contained herein are subject to change without notice to improve performance characteristics. Consult us, or our representatives before use, to confirm that the information in this datasheet is up to date.
2. The information in this datasheet is intended to illustrate the operation and characteristics of our products. We neither make warranties or representations with respect to the accuracy or completeness of the information contained in this datasheet nor grant any license to any intellectual property rights of ours or any third party concerning with the information in this datasheet.
3. Applicable export control laws and regulations should be complied and the procedures required by such laws and regulations should also be followed, when the product or any information contained in this datasheet is exported.
4. The product is neither intended nor warranted for use in equipment of systems which require extremely high levels of quality and/or reliability and/or a malfunction or failure which may cause loss of human life, bodily injury, serious property damage including but not limited to devices or equipment used in 1) nuclear facilities, 2) aerospace industry, 3) medical facilities, 4) automobile industry and other transportation industry and 5) safety devices and safety equipment to control combustions and explosions. Do not use the product for the above use unless agreed by us in writing in advance.
5. Although we make continuous efforts to improve the quality and reliability of our products; nevertheless Semiconductors are likely to fail with a certain probability. So in order to prevent personal injury and/or property damage resulting from such failure, customers are required to incorporate adequate safety measures in their designs, such as system fail safes, redundancy and fire prevention features.
6. Our products are not designed to be Radiation-resistant.
7. Please use the product listed in this datasheet within the specified ranges.
8. We assume no responsibility for damage or loss due to abnormal use.
9. All rights reserved. No part of this datasheet may be copied or reproduced unless agreed by Torex Semiconductor Ltd in writing in advance.

TOREX SEMICONDUCTOR LTD.

## Looking for pricing, stock, or lifecycle information?

Click below to explore more details on WIN SOURCE:

-  [View XC6213B122GR on WIN SOURCE](#)
-  [Torex Semiconductor Ltd Information](#)

## Optimize Your Supply Chain with WIN SOURCE Solutions

-  Global Sourcing Solution
-  Obsolete Management
-  Cost Control Management
-  Shortage Management
-  Alternative Solution
-  Excess Inventory Management