



**THE DATASHEET OF
XC6217A282GRN**



200mA High Speed "Green Operation" LDO Voltage Regulators

■ GENERAL DESCRIPTION

☆GreenOperation Compatible

The XC6217 series are precise, low noise, high speed, low dropout regulators with green operation (GO) function. They are fabricated using Torex's CMOS process. Performance features of the series include high ripple rejection and low dropout voltage, and the series include a reference voltage source, an error amplifier, a current limiter, and a phase compensation circuit.

GO provides high speed operation, low power consumption and high efficiencies by automatically switching between a high speed mode (HS) and a power save mode (PS) depending upon the load current level. The switching point of the GO to the output current is being fixed inside the IC. When only high-speed operation is required, it can be fixed by inputting a high level signal to the GO pin, thus providing operating conditions with the most suitable level of supply current for the application.

The CE function enables the output to be turned off resulting in greatly reduced power consumption. In this state, with the XC6217 series B/D Type, the IC turns on the internal switch located between the V_{OUT} and V_{SS} pins. This short enables the electric charge at the output capacitor (C_L) to be discharged via the internal auto-discharge resistance, and as a result the V_{OUT} pin quickly returns to the V_{SS} level. The series' output stabilization capacitor (C_L) is also compatible with low ESR ceramic capacitors.

Output voltage is selectable in 0.05V increments within a range of 0.80V~4.00V, using laser trimming technologies.

The current limiter's foldback circuit also operates as a short circuit protection for the output current limiter and the output pin.

■ APPLICATIONS

- Smart phones / Mobile phones
- Portable game consoles
- Digital still cameras / Camcorders
- Digital audio equipments

■ FEATURES

Output Current	: 200mA <Limit: 250mA TYP.>
Dropout Voltage	: 80mV@ $I_{OUT}=100mA$, $V_{OUT}=3.0V$
Operating Voltage Range	: 1.6V ~ 6.0V ($0.8V \leq V_{OUT} \leq 1.55V$) 1.8V ~ 6.0V ($1.6V \leq V_{OUT} \leq 4.0V$)
Output Voltage Range	: 0.80V~4.00V (0.05V increments)
Accuracy	: $\pm 2\%$ (HS: $V_{OUT} \geq 2.00V$) (Standard) $\pm 30mV$ (HS: $V_{OUT} \leq 1.95V$) (Standard) $+2.5\%$, -3.5% (PS: $V_{OUT} \geq 2.60V$) (Standard) $+3.5\%$, -4.5% (PS: $1.60 \leq V_{OUT} \leq 2.55V$) (Standard) $+70mV$, $-90mV$ (PS: $0.80 \leq V_{OUT} \leq 1.55V$) (Standard) $\pm 1\%$ (HS: $V_{OUT} \geq 2.00V$) (High Accuracy) $\pm 20mV$ (HS: $V_{OUT} \leq 1.95V$) (High Accuracy) $+1.5\%$, -2.5% (PS: $V_{OUT} \geq 2.60V$) (High Accuracy) $+2.5\%$, -3.5% (PS: $1.60 \leq V_{OUT} \leq 2.55V$) (High Accuracy) $+50mV$, $-70mV$ (PS: $0.80 \leq V_{OUT} \leq 1.55V$) (High Accuracy)
Low Power Consumption	: TYP. $4.5 \mu A$ when PS mode TYP. $25 \mu A$ when HS mode
Standby Current	: Less than $0.1 \mu A$
High Ripple Rejection	: 70dB @ 1kHz (When HS mode)
Low ESR Capacitor	: $1.0 \mu F$ Ceramic capacitor
Regulators with Green Operation (GO) Function	
C_L High-Speed-Discharge (XC6217B/D)	
Operating Ambient Temperature	: $-40^\circ C \sim +85^\circ C$
Packages	: USP-4D, SOT-25(XC6217 Series A/B Type) SSOT-24,USPN-4(XC6217 Series C/D Type)
Environmentally Friendly	: EU RoHS Compliant, Pb Free

■ TYPICAL APPLICATION CIRCUIT

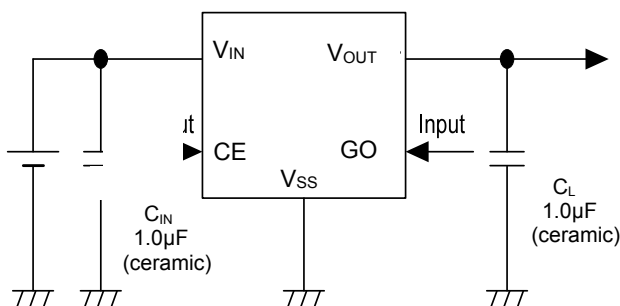

■ TYPICAL PERFORMANCE CHARACTERISTICS



BLOCK DIAGRAMS

●XC6217 Series A Type



●XC6217 Series B Type



●XC6217 Series C Type



●XC6217 Series D Type



*Diodes inside the circuit are an ESD protection diode and a parasitic diode.

■ PRODUCT CLASSIFICATION

● Ordering Information

XC6217①②③④⑤⑥-⑦^(*)

DESIGNATOR	DESCRIPTION	SYMBOL	DESCRIPTION															
①	Type of Regulator	A	CE High Active, no C _L discharge resistor															
		B	CE High Active, with C _L discharge resistor															
		C	CE High Active, no C _L discharge resistor, no GO pin															
		D	CE High Active, with C _L discharge resistor, no GO pin															
②③	Output Voltage	08 ~ 40	ex.) V _{OUT(T)} = 3.00V → ② = 3, ③ = 0															
④	Output Accuracy	2	0.1V increments (Standard)															
			<table border="1"> <thead> <tr> <th>V_{OUT}^(*)</th> <th>HS mode</th> <th>PS mode</th> </tr> </thead> <tbody> <tr> <td>0.80V ~ 1.50V</td> <td>V_{OUT(T)} ± 30mV</td> <td>V_{OUT(T)}+70mV, V_{OUT(T)}-90mV</td> </tr> <tr> <td>1.60V ~ 1.90V</td> <td>V_{OUT(T)} ± 30mV</td> <td>V_{OUT(T)}+3.5%, V_{OUT(T)}-4.5%</td> </tr> <tr> <td>2.00V ~ 2.50V</td> <td>V_{OUT(T)} ± 2%</td> <td>V_{OUT(T)}+3.5%, V_{OUT(T)}-4.5%</td> </tr> <tr> <td>2.60V ~ 4.00V</td> <td>V_{OUT(T)} ± 2%</td> <td>V_{OUT(T)}+2.5%, V_{OUT(T)}-3.5%</td> </tr> </tbody> </table>	V _{OUT} ^(*)	HS mode	PS mode	0.80V ~ 1.50V	V _{OUT(T)} ± 30mV	V _{OUT(T)} +70mV, V _{OUT(T)} -90mV	1.60V ~ 1.90V	V _{OUT(T)} ± 30mV	V _{OUT(T)} +3.5%, V _{OUT(T)} -4.5%	2.00V ~ 2.50V	V _{OUT(T)} ± 2%	V _{OUT(T)} +3.5%, V _{OUT(T)} -4.5%	2.60V ~ 4.00V	V _{OUT(T)} ± 2%	V _{OUT(T)} +2.5%, V _{OUT(T)} -3.5%
			V _{OUT} ^(*)	HS mode	PS mode													
			0.80V ~ 1.50V	V _{OUT(T)} ± 30mV	V _{OUT(T)} +70mV, V _{OUT(T)} -90mV													
			1.60V ~ 1.90V	V _{OUT(T)} ± 30mV	V _{OUT(T)} +3.5%, V _{OUT(T)} -4.5%													
			2.00V ~ 2.50V	V _{OUT(T)} ± 2%	V _{OUT(T)} +3.5%, V _{OUT(T)} -4.5%													
		2.60V ~ 4.00V	V _{OUT(T)} ± 2%	V _{OUT(T)} +2.5%, V _{OUT(T)} -3.5%														
		ex.) 2.00V Standard → ②=2, ③=0, ④=2																
		A	0.05V increments (Standard)															
			<table border="1"> <thead> <tr> <th>V_{OUT}^(*)</th> <th>HS mode</th> <th>PS mode</th> </tr> </thead> <tbody> <tr> <td>0.85V ~ 1.55V</td> <td>V_{OUT(T)} ± 30mV</td> <td>V_{OUT(T)}+70mV, V_{OUT(T)}-90mV</td> </tr> <tr> <td>1.65V ~ 1.95V</td> <td>V_{OUT(T)} ± 30mV</td> <td>V_{OUT(T)}+3.5%, V_{OUT(T)}-4.5%</td> </tr> <tr> <td>2.05V ~ 2.55V</td> <td>V_{OUT(T)} ± 2%</td> <td>V_{OUT(T)}+3.5%, V_{OUT(T)}-4.5%</td> </tr> <tr> <td>2.65V ~ 3.95V</td> <td>V_{OUT(T)} ± 2%</td> <td>V_{OUT(T)}+2.5%, V_{OUT(T)}-3.5%</td> </tr> </tbody> </table>	V _{OUT} ^(*)	HS mode	PS mode	0.85V ~ 1.55V	V _{OUT(T)} ± 30mV	V _{OUT(T)} +70mV, V _{OUT(T)} -90mV	1.65V ~ 1.95V	V _{OUT(T)} ± 30mV	V _{OUT(T)} +3.5%, V _{OUT(T)} -4.5%	2.05V ~ 2.55V	V _{OUT(T)} ± 2%	V _{OUT(T)} +3.5%, V _{OUT(T)} -4.5%	2.65V ~ 3.95V	V _{OUT(T)} ± 2%	V _{OUT(T)} +2.5%, V _{OUT(T)} -3.5%
			V _{OUT} ^(*)	HS mode	PS mode													
			0.85V ~ 1.55V	V _{OUT(T)} ± 30mV	V _{OUT(T)} +70mV, V _{OUT(T)} -90mV													
1.65V ~ 1.95V	V _{OUT(T)} ± 30mV		V _{OUT(T)} +3.5%, V _{OUT(T)} -4.5%															
2.05V ~ 2.55V	V _{OUT(T)} ± 2%		V _{OUT(T)} +3.5%, V _{OUT(T)} -4.5%															
2.65V ~ 3.95V	V _{OUT(T)} ± 2%	V _{OUT(T)} +2.5%, V _{OUT(T)} -3.5%																
ex.) 2.05V Standard → ②=2, ③=0, ④=A																		
1	0.1V increments (High Accuracy)																	
	<table border="1"> <thead> <tr> <th>V_{OUT}^(*)</th> <th>HS mode</th> <th>PS mode</th> </tr> </thead> <tbody> <tr> <td>0.80V ~ 1.50V</td> <td>V_{OUT(T)} ± 20mV</td> <td>V_{OUT(T)}+50mV, V_{OUT(T)}-70mV</td> </tr> <tr> <td>1.60V ~ 1.90V</td> <td>V_{OUT(T)} ± 20mV</td> <td>V_{OUT(T)}+2.5%, V_{OUT(T)}-3.5%</td> </tr> <tr> <td>2.00V ~ 2.50V</td> <td>V_{OUT(T)} ± 1%</td> <td>V_{OUT(T)}+2.5%, V_{OUT(T)}-3.5%</td> </tr> <tr> <td>2.60V ~ 4.00V</td> <td>V_{OUT(T)} ± 1%</td> <td>V_{OUT(T)}+1.5%, V_{OUT(T)}-2.5%</td> </tr> </tbody> </table>	V _{OUT} ^(*)	HS mode	PS mode	0.80V ~ 1.50V	V _{OUT(T)} ± 20mV	V _{OUT(T)} +50mV, V _{OUT(T)} -70mV	1.60V ~ 1.90V	V _{OUT(T)} ± 20mV	V _{OUT(T)} +2.5%, V _{OUT(T)} -3.5%	2.00V ~ 2.50V	V _{OUT(T)} ± 1%	V _{OUT(T)} +2.5%, V _{OUT(T)} -3.5%	2.60V ~ 4.00V	V _{OUT(T)} ± 1%	V _{OUT(T)} +1.5%, V _{OUT(T)} -2.5%		
	V _{OUT} ^(*)	HS mode	PS mode															
	0.80V ~ 1.50V	V _{OUT(T)} ± 20mV	V _{OUT(T)} +50mV, V _{OUT(T)} -70mV															
	1.60V ~ 1.90V	V _{OUT(T)} ± 20mV	V _{OUT(T)} +2.5%, V _{OUT(T)} -3.5%															
	2.00V ~ 2.50V	V _{OUT(T)} ± 1%	V _{OUT(T)} +2.5%, V _{OUT(T)} -3.5%															
2.60V ~ 4.00V	V _{OUT(T)} ± 1%	V _{OUT(T)} +1.5%, V _{OUT(T)} -2.5%																
ex.) 2.00V High Accuracy → ②=2, ③=0, ④=1																		
B	0.05V increments (High Accuracy)																	
	<table border="1"> <thead> <tr> <th>V_{OUT}^(*)</th> <th>HS mode</th> <th>PS mode</th> </tr> </thead> <tbody> <tr> <td>0.85V ~ 1.55V</td> <td>V_{OUT(T)} ± 20mV</td> <td>V_{OUT(T)}+50mV, V_{OUT(T)}-70mV</td> </tr> <tr> <td>1.65V ~ 1.95V</td> <td>V_{OUT(T)} ± 20mV</td> <td>V_{OUT(T)}+2.5%, V_{OUT(T)}-3.5%</td> </tr> <tr> <td>2.05V ~ 2.55V</td> <td>V_{OUT(T)} ± 1%</td> <td>V_{OUT(T)}+2.5%, V_{OUT(T)}-3.5%</td> </tr> <tr> <td>2.65V ~ 3.95V</td> <td>V_{OUT(T)} ± 1%</td> <td>V_{OUT(T)}+1.5%, V_{OUT(T)}-2.5%</td> </tr> </tbody> </table>	V _{OUT} ^(*)	HS mode	PS mode	0.85V ~ 1.55V	V _{OUT(T)} ± 20mV	V _{OUT(T)} +50mV, V _{OUT(T)} -70mV	1.65V ~ 1.95V	V _{OUT(T)} ± 20mV	V _{OUT(T)} +2.5%, V _{OUT(T)} -3.5%	2.05V ~ 2.55V	V _{OUT(T)} ± 1%	V _{OUT(T)} +2.5%, V _{OUT(T)} -3.5%	2.65V ~ 3.95V	V _{OUT(T)} ± 1%	V _{OUT(T)} +1.5%, V _{OUT(T)} -2.5%		
	V _{OUT} ^(*)	HS mode	PS mode															
	0.85V ~ 1.55V	V _{OUT(T)} ± 20mV	V _{OUT(T)} +50mV, V _{OUT(T)} -70mV															
	1.65V ~ 1.95V	V _{OUT(T)} ± 20mV	V _{OUT(T)} +2.5%, V _{OUT(T)} -3.5%															
	2.05V ~ 2.55V	V _{OUT(T)} ± 1%	V _{OUT(T)} +2.5%, V _{OUT(T)} -3.5%															
2.65V ~ 3.95V	V _{OUT(T)} ± 1%	V _{OUT(T)} +1.5%, V _{OUT(T)} -2.5%																
ex.) 2.05V High Accuracy → ②=2, ③=0, ④=B																		
⑤⑥-⑦	Packages (Order Unit)	GR	USP-4D (XC6217 Series A/B type) (3,000pcs/Reel)															
		GR-G	USP-4D (XC6217 Series A/B type) (3,000pcs/Reel)															
		MR	SOT-25 (XC6217 Series A/B type) (3,000pcs/Reel)															
		MR-G	SOT-25 (XC6217 Series A/B type) (3,000pcs/Reel)															
		NR	SSOT-24 (XC6217 Series C/D type) (3,000pcs/Reel)															
		NR-G	SSOT-24 (XC6217 Series C/D type) (3,000pcs/Reel)															
		7R-G	USPN-4 (XC6217 Series C/D type) ^(*) (5,000pcs/Reel)															

^(*) The "-G" suffix denotes Halogen and Antimony free as well as being fully EU RoHS compliant.

^(*) Output Range of USPN-4 1.6V ≤ V_{OUT} ≤ 4.00V

● Selection Guide

Type	GO Pin	C _L Discharge
A	YES	NO
B	YES	YES
C	NO	NO
D	NO	YES

PIN CONFIGURATION



The USP-4D, USPN-4 heat dissipation pad is recommended to solder in use of the reference mount pattern and metal mask pattern for the mounting strength and heat dissipation.

PIN ASSIGNMENT

PIN NUMBER				PIN NAME	FUNCTION
USP-4D	SOT-25	SSOT-24	USPN-4		
4	1	4	4	V _{IN}	Power Input
1	5	3	1	V _{OUT}	Output
2	4	-	-	GO	Green Operation Mode Switch
5	2	2	2	V _{SS}	Ground
3	3	1	3	CE	ON/OFF Control

* XC6217 Series A/B type: USP-4D package
 XC6217 Series A/B type: SOT-25 package
 XC6217 Series C/D type: SSOT-24 package
 XC6217 Series C/D type: USPN-4 package

FUNCTION CHART

PIN NAME	LOGIC	IC CONDITION
CE	L	OFF
	H	ON
	OPEN	Undefined operation
GO ^(*1)	L	GO Mode ^(*2)
	H	HS Mode
	OPEN	Undefined operation

^(*1) Since there is no GO pin about SSOT-24 and USPN-4, they always operate by GO Mode.

^(*2) GO mode = PS/HS auto switching

PowerSave(PS) mode : Low supply current

HighSpeed(HS) mode : High Speed

^(*3) CE pin and GO pin should not be left open. Each should have a certain voltage.

■ ABSOLUTE MAXIMUM RATINGS

Ta=25°C

PARAMETER		SYMBOL	RATINGS	UNITS
Input Voltage		V _{IN}	V _{SS} - 0.3 ~ +6.5	V
Output Current		I _{OUT}	400 ^(*)	mA
Output Voltage		V _{OUT}	V _{SS} - 0.3 ~ V _{IN} + 0.3	V
CE/GO Input Voltage		V _{CE/VGO}	V _{SS} - 0.3 ~ +6.5	V
Power Dissipation	USP-4D	Pd	120	mW
			650 (40mmx40mm Standard board) ^(**)	
	SOT-25		250	
			600 (40mmx40mm Standard board) ^(**)	
	SSOT-24		150	
			500 (40mmx40mm Standard board) ^(**)	
USPN-4	100			
	600 (40mmx40mm Standard board) ^(**)			
Operating Ambient Temperature		T _{opr}	- 40 ~ + 85	°C
Storage Temperature		T _{stg}	- 55 ~ +125	°C

^(*): I_{OUT} ≤ Pd / (V_{IN} - V_{OUT})

^(**): The power dissipation figure shown is PCB mounted and is for reference only.

Please see the power dissipation page for the mounting condition.

ELECTRICAL CHARACTERISTICS

●XC6217 series A/B Type

Ta=25°C

PARAMETER	SYMBOL	CONDITIONS	MIN.	TYP.	MAX.	UNITS	CIRCUIT
Output Voltage (Standard)	$V_{OUT(E)}$ (*2)	High Speed Mode (HS) $V_{OUT(T)} \geq 2.00V$ $V_{GO} = V_{IN}, V_{CE} = V_{IN}, I_{OUT} = 10mA$	$V_{OUT(T)}$ $\times 0.98$	$V_{OUT(T)}$ (*3)	$V_{OUT(T)}$ $\times 1.02$	V	①
		High Speed Mode (HS) $V_{OUT(T)} \leq 1.95V$ $V_{GO} = V_{IN}, V_{CE} = V_{IN}, I_{OUT} = 10mA$	$V_{OUT(T)}$ -0.03		$V_{OUT(T)}$ +0.03		
		Power Save Mode (PS) $V_{OUT(T)} \geq 2.60V$ $V_{GO} = V_{SS}, V_{CE} = V_{IN}, I_{OUT} = 0.1mA$	$V_{OUT(T)}$ $\times 0.965$		$V_{OUT(T)}$ $\times 1.025$		
		Power Save Mode (PS) $1.60V \leq V_{OUT(T)} \leq 2.55V$ $V_{GO} = V_{SS}, V_{CE} = V_{IN}, I_{OUT} = 0.1mA$	$V_{OUT(T)}$ $\times 0.955$		$V_{OUT(T)}$ $\times 1.035$		
		Power Save Mode (PS) $0.80V \leq V_{OUT(T)} \leq 1.55V$ $V_{GO} = V_{SS}, V_{CE} = V_{IN}, I_{OUT} = 0.1mA$	$V_{OUT(T)}$ -0.09		$V_{OUT(T)}$ +0.07		
Output Voltage (High Accuracy)	$V_{OUT(E)}$ (*2)	High Speed Mode (HS) $V_{OUT(T)} \geq 2.00V$ $V_{GO} = V_{IN}, V_{CE} = V_{IN}, I_{OUT} = 10mA$	$V_{OUT(T)}$ $\times 0.99$	$V_{OUT(T)}$ (*3)	$V_{OUT(T)}$ $\times 1.01$	V	①
		High Speed Mode (HS) $V_{OUT(T)} \leq 1.95V$ $V_{GO} = V_{IN}, V_{CE} = V_{IN}, I_{OUT} = 10mA$	$V_{OUT(T)}$ -0.02		$V_{OUT(T)}$ +0.02		
		Power Save Mode (PS) $V_{OUT(T)} \geq 2.60V$ $V_{GO} = V_{SS}, V_{CE} = V_{IN}, I_{OUT} = 0.1mA$	$V_{OUT(T)}$ $\times 0.975$		$V_{OUT(T)}$ $\times 1.015$		
		Power Save Mode (PS), $1.60V \leq V_{OUT(T)} \leq 2.55V$ $V_{GO} = V_{SS}, V_{CE} = V_{IN}, I_{OUT} = 0.1mA$	$V_{OUT(T)}$ $\times 0.965$		$V_{OUT(T)}$ $\times 1.025$		
		Power save mode (PS), $0.80V \leq V_{OUT(T)} \leq 1.55V$ $V_{GO} = V_{SS}, V_{CE} = V_{IN}, I_{OUT} = 0.1mA$	$V_{OUT(T)}$ -0.07		$V_{OUT(T)}$ +0.05		
Output Current	I_{OUTMAX}	$V_{GO} = V_{IN}(HS), V_{CE} = V_{IN}$ $V_{IN} = V_{OUT(T)} + 1.0V$ $0.80V \leq V_{OUT(T)} \leq 4.00V$	200	250	-	mA	①
Load Regulation	ΔV_{OUT}	$V_{GO} = V_{IN}(HS), V_{CE} = V_{IN}$ $0.1mA \leq I_{OUT} \leq 100mA$		10	40	mV	①
Dropout Voltage (*4)	V_{dif}	$V_{GO} = V_{IN}(HS), V_{CE} = V_{IN}, I_{OUT} = 100mA$		[E-2]		mV	①
Supply Current 1	I_{SS1}	$V_{CE} = V_{IN}, V_{GO} = V_{IN}(HS), I_{OUT} = 0mA$	-	25	50	μA	②
Supply Current 2	I_{SS2}	$V_{CE} = V_{IN}, V_{GO} = V_{SS}(PS), I_{OUT} = 0mA$	-	4.5	8.0	μA	②
Standby Current	I_{STB}	$V_{IN} = 6.0V, V_{CE} = V_{SS}$	-	0.01	0.10	μA	②
Line Regulation	ΔV_{OUT} ($\Delta V_{IN} \cdot V_{OUT}$)	$V_{OUT(T)} + 0.5V \leq V_{IN} \leq 6.0V$ $V_{OUT(T)} \geq 1.10V$ $V_{GO} = V_{IN}(HS), V_{CE} = V_{IN}, I_{OUT} = 10mA$	-	0.01	0.20	%V	①
		$1.6V \leq V_{IN} \leq 6.0V$ $V_{OUT(T)} \leq 1.05V$ $V_{GO} = V_{IN}(HS), V_{CE} = V_{IN}, I_{OUT} = 10mA$					
Input Voltage	V_{IN}	$0.80V \leq V_{OUT(T)} \leq 1.55V$	1.6	-	6.0	V	①
Output Voltage Temperature Characteristics	$\Delta V_{OUT}/$ ($\Delta T_{opr} \cdot V_{OUT}$)	$V_{GO} = V_{IN}, V_{CE} = V_{IN}$ $I_{OUT} = 30mA$ $-40^\circ C \leq T_{opr} \leq 85^\circ C$	-	± 100	-	ppm/°C	①

■ ELECTRICAL CHARACTERISTICS (Continued)

● XC6217 series A/B Type (Continued)

Ta=25°C

PARAMETER	SYMBOL	CONDITIONS	MIN.	TYP.	MAX.	UNITS	CIRCUIT
Ripple Rejection Rate	PSRR	V _{IN} ={V _{OUT(T)} +1.0}V _{DC} +0.5V _{p-pAC} 0.85V ≤ V _{OUT(T)} ≤ 4.00V V _{GO} =V _{IN} (HS), V _{CE} =V _{IN} I _{OUT} =30mA, f=1kHz	-	70	-	dB	③
		V _{IN} =1.85V _{DC} +0.5V _{p-pAC} V _{OUT(T)} =0.80V V _{GO} =V _{IN} (HS), V _{CE} =V _{IN} I _{OUT} =30mA, f=1kHz					
Limit Current	I _{LIM}	V _{GO} =V _{IN} (HS), V _{CE} =V _{IN}	200	250	-	mA	①
Short Current	I _{SHORT}	V _{GO} =V _{IN} (HS), V _{CE} =V _{IN} V _{OUT} is short-circuited to the V _{SS} level.	-	30	-	mA	①
PS Switching Current	I _{GOR}	V _{CE} =V _{IN} V _{GO} =V _{SS} (GO mode), I _{OUT} : heavy to light load	0.5	-	-	mA	④
HS Switching Current	I _{GO}	V _{CE} =V _{IN} , V _{GO} =V _{SS} (GO mode), I _{OUT} : light to heavy load	-	-	8.0	mA	④
Switch Current Hysteresis Range	I _{GOhys}	I _{GOhys} =I _{GO} - I _{GOR}	-	3.5	-	mA	④
PS Switching Delay Time	t _{DPS}	V _{CE} =V _{IN} , V _{GO} =V _{SS} (GO mode)	-	-	[E-3]	μs	④
CE High Level Voltage	V _{CEH}		1.2	-	6.0	V	④
GO High Level Voltage	V _{GOH}	V _{CE} =V _{IN} , I _{SS} Search, I _{OUT} =0mA	1.2	-	6.0	V	④
CE Low Level Voltage	V _{CEL}		-	-	0.3	V	④
GO Low Level Voltage	V _{GOL}	V _{CE} =V _{IN} , I _{SS} Search, I _{OUT} =0mA	-	-	0.3	V	④
CE High Level Current	I _{CEH}	V _{GO} =V _{IN} , V _{CE} =V _{IN}	-0.1	-	0.1	μA	④
GO High Level Current	I _{GOH}	V _{GO} =V _{IN} , V _{CE} =V _{IN}	-0.1	-	0.1	μA	④
CE Low Level Current	I _{CEL}	V _{CE} =V _{SS} , V _{GO} =V _{SS}	-0.1	-	0.1	μA	④
GO Low Level Current	I _{GOL}	V _{CE} =V _{SS} , V _{GO} =V _{SS}	-0.1	-	0.1	μA	④
CL Auto-Discharge Resistance (*7)	R _{DCHG}	V _{IN} =6.0V, V _{OUT} =4.00V, V _{CE} =V _{GO} =V _{SS}	-	780	-	Ω	①

NOTE:

- * 1: Unless otherwise stated regarding input voltage conditions, V_{IN}=V_{OUT(T)}+1.0V.
- * 2: V_{OUT(E)} = Effective output voltage (Refer to the voltage chart E-1)
(I.e. the output voltage when an amply stabilized "V_{OUT(T)} +1.0V" is provided at the V_{IN} pin while maintaining a certain I_{OUT} value.)
- * 3: V_{OUT(T)} = Nominal output voltage
- * 4: V_{dif} = {V_{IN1} (*6)-V_{OUT1} (*5)}
- * 5: V_{OUT1}=A voltage equal to 98% of the output voltage whenever an amply stabilized I_{OUT} {V_{OUT(T)} +1.0V} is input in the HS mode.
- * 6: V_{IN1}=the input voltage when V_{OUT1} appears as input voltage is gradually decreased.
- * 7: For the XC6217 series B type only. The XC6217 series A type discharges by resistors R1 and R2 only as shown in the block diagrams.

ELECTRICAL CHARACTERISTICS (Continued)

●XC6217 series C/D Type

Ta=25°C

PARAMETER	SYMBOL	CONDITIONS	MIN.	TYP.	MAX.	UNITS	CIRCUIT
Output Voltage (Standard)	$V_{OUT(E)}$ (*2)	High Speed Mode (HS) $V_{OUT(T)} \geq 2.00V$ $V_{CE} = V_{IN}, I_{OUT} = 10mA$	$V_{OUT(T)}$ $\times 0.98$ (*3)	$V_{OUT(T)}$ (*3)	$V_{OUT(T)}$ $\times 1.02$	V	①
		High Speed Mode(HS) $V_{OUT(T)} \leq 1.95V$ $V_{CE} = V_{IN}, I_{OUT} = 10mA$	$V_{OUT(T)}$ -0.03 (*3)		$V_{OUT(T)}$ $+0.03$		
		Power Save Mode (PS) $V_{OUT(T)} \geq 2.60V$ $V_{CE} = V_{IN}, I_{OUT} = 0.1mA$	$V_{OUT(T)}$ $\times 0.965$ (*3)		$V_{OUT(T)}$ $\times 1.025$		
		Power Save Mode (PS) $1.60V \leq V_{OUT(T)} \leq 2.55V$ $V_{CE} = V_{IN}, I_{OUT} = 0.1mA$	$V_{OUT(T)}$ $\times 0.955$ (*3)		$V_{OUT(T)}$ $\times 1.035$		
		Power Save Mode(PS) $0.80V \leq V_{OUT(T)} \leq 1.55V$ $V_{CE} = V_{IN}, I_{OUT} = 0.1mA$	$V_{OUT(T)}$ -0.09 (*3)		$V_{OUT(T)}$ $+0.07$		
Output Voltage (High Accuracy)	$V_{OUT(E)}$ (*2)	High Speed Mode (HS) $V_{OUT(T)} \geq 2.00V$ $V_{CE} = V_{IN}, I_{OUT} = 10mA$	$V_{OUT(T)}$ $\times 0.99$	$V_{OUT(T)}$ (*3)	$V_{OUT(T)}$ $\times 1.01$	V	①
		High Speed Mode(HS) $V_{OUT(T)} \leq 1.95V$ $V_{CE} = V_{IN}, I_{OUT} = 10mA$	$V_{OUT(T)}$ -0.02		$V_{OUT(T)}$ $+0.02$		
		Power Save Mode (PS) $V_{OUT(T)} \geq 2.60V$ $V_{CE} = V_{IN}, I_{OUT} = 0.1mA$	$V_{OUT(T)}$ $\times 0.975$		$V_{OUT(T)}$ $\times 1.015$		
		Power Save Mode (PS) $1.60V \leq V_{OUT(T)} \leq 2.55V$ $V_{CE} = V_{IN}, I_{OUT} = 0.1mA$	$V_{OUT(T)}$ $\times 0.965$		$V_{OUT(T)}$ $\times 1.025$		
		Power Save Mode(PS) $0.80V \leq V_{OUT(T)} \leq 1.55V$ $V_{CE} = V_{IN}, I_{OUT} = 0.1mA$	$V_{OUT(T)}$ -0.07		$V_{OUT(T)}$ $+0.05$		
Output Current	I_{OUTMAX}	$V_{CE} = V_{IN}, V_{IN} = V_{OUT(T)} + 1.0V,$ $0.80V \leq V_{OUT(T)} \leq 4.00V$	200	250	-	mA	①
Load Regulation	ΔV_{OUT}	$V_{CE} = V_{IN}, 8mA \leq I_{OUT} \leq 100mA$	-	10	40	mV	①
Dropout Voltage (*4)	V_{dif}	$V_{CE} = V_{IN}, I_{OUT} = 100mA$	[E-2]			mV	①
Supply Current 1	I_{SS1}	$V_{CE} = V_{IN}, I_{OUT} = 8mA$	-	25	50	μA	④
Supply Current 2	I_{SS2}	$V_{CE} = V_{IN}, I_{OUT} = 0mA$	-	4.5	8.0	μA	②
Standby Current	I_{STBY}	$V_{IN} = 6.0V, V_{CE} = V_{SS}$	-	0.01	0.10	μA	②
Line Regulation	$\frac{\Delta V_{OUT}}{(\Delta V_{IN} \cdot V_{OUT})}$	$V_{OUT(T)} + 0.5V \leq V_{IN} \leq 6.0V$ $V_{OUT(T)} \geq 1.10V$ $V_{CE} = V_{IN}, I_{OUT} = 10mA$	-	0.01	0.20	%V	①
		$1.6V \leq V_{IN} \leq 6.0V$ $V_{OUT(T)} \leq 1.05V$ $V_{CE} = V_{IN}, I_{OUT} = 10mA$					
Input Voltage	V_{IN}		1.6	-	6.0	V	①
Output Voltage Temperature Characteristics	$\frac{\Delta V_{OUT}}{(\Delta T_{opr} \cdot V_{OUT})}$	$V_{CE} = V_{IN}, I_{OUT} = 30mA$ $-40^\circ C \leq T_{opr} \leq 85^\circ C$	-	± 100	-	ppm/°C	①

■ ELECTRICAL CHARACTERISTICS (Continued)

● XC6217 series C/D Type (Continued)

Ta=25°C

PARAMETER	SYMBOL	CONDITIONS	MIN.	TYP.	MAX.	UNITS	CIRCUIT
Ripple Rejection Rate	PSRR	$V_{IN}=\{V_{OUT(T)}+1.0\}V_{DC}+0.5V_{P-PAC}$ $0.85V \leq V_{OUT(T)} \leq 4.00V$ $V_{CE}=V_{IN}, I_{OUT}=30mA, f=1kHz$	-	70	-	dB	③
		$V_{IN}=1.85V_{DC}+0.5V_{P-PAC}$ $V_{OUT(T)}=0.80V$ $V_{CE}=V_{IN}, I_{OUT}=30mA, f=1kHz$					
Limit Current	I _{LIM}	$V_{CE}=V_{IN}$	200	250	-	mA	①
Short Current	I _{SHORT}	$V_{CE}=V_{IN}$ V _{OUT} is short-circuited at the V _{SS} level.		30	-	mA	①
PS Switching Current	I _{GOR}	$V_{CE}=V_{IN}, I_{OUT}$: heavy to light load	0.5	-	-	mA	④
HS Switching Current	I _{GO}	$V_{CE}=V_{IN}, I_{OUT}$: light to heavy load	-	-	8.0	mA	④
Switch Current Hysteresis Range	I _{GOhys}	$I_{GOhys}=I_{GO}-I_{GOR}$	-	3.5	-	mA	④
PS Switching Delay Time	t _{DPS}	$V_{CE}=V_{IN}$	-	-	[E-3]	μs	④
CE High Level Voltage	V _{CEH}		1.2		6.0	V	④
CE Low Level Voltage	V _{CEL}		-	-	0.3	V	④
CE High Level Current	I _{CEH}	$V_{CE}=V_{IN}$	-0.1	-	0.1	μA	④
CE Low Level Current	I _{CEL}	$V_{CE}=V_{SS}$	-0.1	-	0.1	μA	④
CL Auto-Discharge Resistance (*7)	R _{DCHG}	$V_{IN}=6.0V, V_{OUT}=4.00V, V_{CE}=V_{SS}$	-	780	-	Ω	①

NOTE:

- * 1: Unless otherwise stated regarding input voltage conditions, $V_{IN}=V_{OUT(T)}+1.0V$.
- * 2: $V_{OUT(E)}$ = Effective output voltage (Refer to the voltage chart E-1)
(I.e. the output voltage when an amply stabilized " $V_{OUT(T)} + 1.0V$ " is provided at the V_{IN} pin while maintaining a certain I_{OUT} value.)
- * 3: $V_{OUT(T)}$ = Nominal output voltage
- * 4: $V_{dif} = \{V_{IN1}^{(*)6} - V_{OUT1}^{(*)5}\}$
- * 5: V_{OUT1} = A voltage equal to 98% of the output voltage whenever an amply stabilized $I_{OUT} \{V_{OUT(T)} + 1.0V\}$ is input in the HS mode.
- * 6: V_{IN1} = the input voltage when V_{OUT1} appears as input voltage is gradually decreased.
- * 7: For the XC6217 series D Type only. The XC6217 series C Type discharges by resistors R1 and R2 only as shown in the block diagrams.

● OUTPUT VOLTAGE CHART (Continued)

Ta=25°C

OUTPUT VOLTAGE (V)	OUTPUT VOLTAGE (HS MODE) Standard (V)		OUTPUT VOLTAGE (PS MODE) Standard (V)		OUTPUT VOLTAGE (HS MODE) High Accuracy (V)		OUTPUT VOLTAGE (PS MODE) High Accuracy (V)		DROPOUT VOLTAGE I _{OUT} =100mA (mV)		PS SWITCH DELAY TIME (GOMode) (μs)			
	V _{OUT(E)}		V _{OUT(E)}		V _{OUT(E)}		V _{OUT(E)}		V _{dif}		t _{DPS}			
	MIN.	MAX.	MIN.	MAX.	MIN.	MAX.	MIN.	MAX.	TYP.	MAX.	MAX.			
0.80	0.77000	0.83000	0.71000	0.87000	0.78000	0.82000	0.73000	0.85000	500	850	650			
0.85	0.82000	0.88000	0.76000	0.92000	0.83000	0.87000	0.78000	0.90000						
0.90	0.87000	0.93000	0.81000	0.97000	0.88000	0.92000	0.83000	0.95000	410	750		650		
0.95	0.92000	0.98000	0.86000	1.02000	0.93000	0.97000	0.88000	1.00000						
1.00	0.97000	1.03000	0.91000	1.07000	0.98000	1.02000	0.93000	1.05000	330	650			650	
1.05	1.02000	1.08000	0.96000	1.12000	1.03000	1.07000	0.98000	1.10000						
1.10	1.07000	1.13000	1.01000	1.17000	1.08000	1.12000	1.03000	1.15000						
1.15	1.12000	1.18000	1.06000	1.22000	1.13000	1.17000	1.08000	1.20000	230	410				650
1.20	1.17000	1.23000	1.11000	1.27000	1.18000	1.22000	1.13000	1.25000						
1.25	1.22000	1.28000	1.16000	1.32000	1.23000	1.27000	1.18000	1.30000						
1.30	1.27000	1.33000	1.21000	1.37000	1.28000	1.32000	1.23000	1.35000	200	360	650			
1.35	1.32000	1.38000	1.26000	1.42000	1.33000	1.37000	1.28000	1.40000						
1.40	1.37000	1.43000	1.31000	1.47000	1.38000	1.42000	1.33000	1.45000	180	290		650		
1.45	1.42000	1.48000	1.36000	1.52000	1.43000	1.47000	1.38000	1.50000						
1.50	1.47000	1.53000	1.41000	1.57000	1.48000	1.52000	1.43000	1.55000	160	250			850	
1.55	1.52000	1.58000	1.46000	1.62000	1.53000	1.57000	1.48000	1.60000						
1.60	1.57000	1.63000	1.52800	1.65600	1.58000	1.62000	1.54400	1.64000	125	210				
1.65	1.62000	1.68000	1.57575	1.70775	1.63000	1.67000	1.59225	1.69125						
1.70	1.67000	1.73000	1.62350	1.75950	1.68000	1.72000	1.64050	1.74250						
1.75	1.72000	1.78000	1.67125	1.81125	1.73000	1.77000	1.68875	1.79375	115	195				850
1.80	1.77000	1.83000	1.71900	1.86300	1.78000	1.82000	1.73700	1.84500						
1.85	1.82000	1.88000	1.76675	1.91475	1.83000	1.87000	1.78525	1.89625						
1.90	1.87000	1.93000	1.81450	1.96650	1.88000	1.92000	1.83350	1.94750	115	195	850			
1.95	1.92000	1.98000	1.86225	2.01825	1.93000	1.97000	1.88175	1.99875						
2.00	1.96000	2.04000	1.91000	2.07000	1.98000	2.02000	1.93000	2.05000	115	195		850		
2.05	2.00900	2.09100	1.95775	2.12175	2.02950	2.07050	1.97825	2.10125						
2.10	2.05800	2.14200	2.00550	2.17350	2.07900	2.12100	2.02650	2.15250						
2.15	2.10700	2.19300	2.05325	2.22525	2.12850	2.17150	2.07475	2.20375						
2.20	2.15600	2.24400	2.10100	2.27700	2.17800	2.22200	2.12300	2.25500						
2.25	2.20500	2.29500	2.14875	2.32875	2.22750	2.27250	2.17125	2.30625						
2.30	2.25400	2.34600	2.19650	2.38050	2.27700	2.32300	2.21950	2.35750						
2.35	2.30300	2.39700	2.24425	2.43225	2.32650	2.37350	2.26775	2.40875						
2.40	2.35200	2.44800	2.29200	2.48400	2.37600	2.42400	2.31600	2.46000						
2.45	2.40100	2.49900	2.33975	2.53575	2.42550	2.47450	2.36425	2.51125						

*USPN-4 1.6V ≤ V_{OUT(T)} ≤ 4.00V。

● OUTPUT VOLTAGE CHART (Continued)

SYMBOL	E-1								E-2		E-3
	NOMINAL OUTPUT VOLTAGE (V)	OUTPUT VOLTAGE (HS MODE) Standard (V)		OUTPUT VOLTAGE (PS MODE) Standard (V)		OUTPUT VOLTAGE (HS MODE) High Accuracy (V)		OUTPUT VOLTAGE (PS MODE) High Accuracy (V)		DROPOUT VOLTAGE $I_{OUT}=100mA(mV)$	PS SWITCH DELAY TIME (GO MODE) (μs)
		$V_{OUT(E)}$		$V_{OUT(E)}$		$V_{OUT(E)}$		$V_{OUT(E)}$			
$V_{OUT(T)}$	MIN.	MAX.	MIN.	MAX.	MIN.	MAX.	MIN.	MAX.	TYP.	MAX.	MAX.
2.50	2.45000	2.55000	2.38750	2.58750	2.47500	2.52500	2.41250	2.56250	95	170	850
2.55	2.49900	2.60100	2.43525	2.63925	2.52450	2.57550	2.46075	2.61375			
2.60	2.54800	2.65200	2.50900	2.66500	2.57400	2.62600	2.53500	2.63900			
2.65	2.59700	2.70300	2.55725	2.71625	2.62350	2.67650	2.58375	2.68975			
2.70	2.64600	2.75400	2.60550	2.76750	2.67300	2.72700	2.63250	2.74050			
2.75	2.69500	2.80500	2.65375	2.81875	2.72250	2.77750	2.68125	2.79125			
2.80	2.74400	2.85600	2.70200	2.87000	2.77200	2.82800	2.73000	2.84200			
2.85	2.79300	2.90700	2.75025	2.92125	2.82150	2.87850	2.77875	2.89275			
2.90	2.84200	2.95800	2.79850	2.97250	2.87100	2.92900	2.82750	2.94350			
2.95	2.89100	3.00900	2.84675	3.02375	2.92050	2.97950	2.87625	2.99425			
3.00	2.94000	3.06000	2.89500	3.07500	2.97000	3.03000	2.92500	3.04500	80	140	1200
3.05	2.98900	3.11100	2.94325	3.12625	3.01950	3.08050	2.97375	3.09575			
3.10	3.03800	3.16200	2.99150	3.17750	3.06900	3.13100	3.02250	3.14650			
3.15	3.08700	3.21300	3.03975	3.22875	3.11850	3.18150	3.07125	3.19725			
3.20	3.13600	3.26400	3.08800	3.28000	3.16800	3.23200	3.12000	3.24800			
3.25	3.18500	3.31500	3.13625	3.33125	3.21750	3.28250	3.16875	3.29875			
3.30	3.23400	3.36600	3.18450	3.38250	3.26700	3.33300	3.21750	3.34950			
3.35	3.28300	3.41700	3.23275	3.43375	3.31650	3.38350	3.26625	3.40025			
3.40	3.33200	3.46800	3.28100	3.48500	3.36600	3.43400	3.31500	3.45100			
3.45	3.38100	3.51900	3.32925	3.53625	3.41550	3.48450	3.36375	3.50175			
3.50	3.43000	3.57000	3.37750	3.58750	3.46500	3.53500	3.41250	3.55250			
3.55	3.47900	3.62100	3.42575	3.63875	3.51450	3.58550	3.46125	3.60325			
3.60	3.52800	3.67200	3.47400	3.69000	3.56400	3.63600	3.51000	3.65400			
3.65	3.57700	3.72300	3.52225	3.74125	3.61350	3.68650	3.55875	3.70475			
3.70	3.62600	3.77400	3.57050	3.79250	3.66300	3.73700	3.60750	3.75550			
3.75	3.67500	3.82500	3.61875	3.84375	3.71250	3.78750	3.65625	3.80625			
3.80	3.72400	3.87600	3.66700	3.89500	3.76200	3.83800	3.70500	3.85700			
3.85	3.77300	3.92700	3.71525	3.94625	3.81150	3.88850	3.75375	3.90775			
3.90	3.82200	3.97800	3.76350	3.99750	3.86100	3.93900	3.80250	3.95850			
3.95	3.87100	4.02900	3.81175	4.04875	3.91050	3.98950	3.85125	4.00925			
4.00	3.92000	4.08000	3.86000	4.10000	3.96000	4.04000	3.90000	4.06000			

*USPN-4 $1.6V \leq V_{OUT(T)} \leq 4.00V$

OPERATIONAL EXPLANATION

<Output Voltage Control>

The voltage divided by resistors R1 & R2 is compared with the internal reference voltage by the error amplifier. The P-channel MOSFET, which is connected to the V_{OUT} pin, is then driven by the subsequent output signal. The output voltage at the V_{OUT} pin is controlled & stabilized by a system of negative feedback. The current limit circuit and short protect circuit operate in relation to the level of output current. The GO function monitors the output current and switches a supply current to two values according to the level of output current. Further, the IC's internal circuitry can be shutdown via the CE pin's signal.

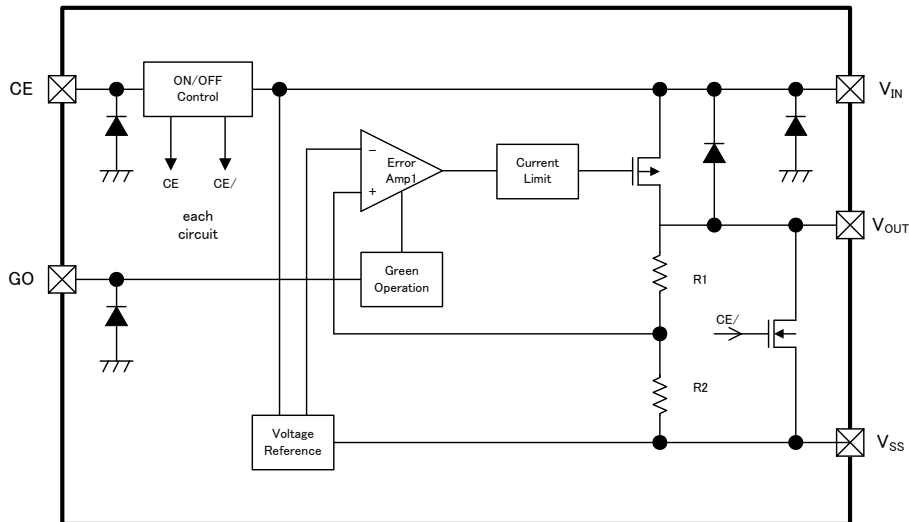

<Green Operation>

XC6217 series A/B types can be set as a fixed high-speed mode or a green operation (GO) mode via a signal to the green operation (GO) pin. Under the condition that the GO pin becomes low level, the IC operates in the GO mode and the IC operates in the fixed high-speed mode when the GO pin is at high level. The XC6217 series C/D types always operates in GO mode (= PS/HS automatic change).

The GO mode enables the IC to switch automatically the supply current to the high speed (HS) mode or the power save (PS) mode according to the level of output current. While having both high-speed operation and low supply current state, the series can acquire high efficiency. At the HS/PS automatic switching mode (GO mode), the switching point of the HS mode and the PS mode is being fixed inside the IC. When the output current becomes I_{GOR} 0.5mA (MIN.) or below, the mode changes automatically to the PS mode after the delay time of hundreds [sec(s)], and it can reduce supply current in light load.

Also when the output current becomes I_{GO} 8mA (MAX.) or more, the mode changes automatically to the HS mode and the IC becomes high speed operation.

When the XC6217 is used in the GO mode, stable operation range is over 8.0mA is HS mode and below 0.5mA in PS mode.

<Low ESR capacitor>

With the XC6217 series, a stable output voltage is achievable even if used with low ESR capacitors, as a phase compensation circuit is built-in. Values required for the phase compensation are as the chart below. In order to ensure the stable phase compensation while avoiding run-out of values, please use the capacitor which does not depend on bias or temperature too much. For a stable power input, please connect an input capacitor (C_{IN}) of 1.0 μF between the V_{IN} pin and the V_{SS} pin.

• Excluding USPN-4

OUTPUT VOLTAGE (V)	OUTPUT CAPACITOR VALUE
0.8 ~ 1.15	More than C _L =4.7 μF
1.2 ~ 1.35	More than C _L =2.2 μF
1.4 ~ 4.0	More than C _L =1.0 μF

• USPN-4

OUTPUT VOLTAGE (V)	OUTPUT CAPACITOR VALUE
1.6 ~ 4.0	More than C _L =2.2 μF

■ OPERATIONAL EXPLANATION (Continued)

<C_L Auto-Discharge Function>

XC6217 series B/D type can quickly discharge the electric charge at the output capacitor (C_L), when a low signal to the CE pin, which enables a whole IC circuit put into OFF state, is inputted via the N-channel transistor located between the V_{OUT} pin and the V_{SS} pin (cf. BLOCK DIAGRAM). The C_L auto-discharge resistance value is fixed to 780 Ω (V_{IN}=6.0V, V_{OUT}=4.0V at typical). The discharge time of the output capacitor (C_L) is set by the C_L auto-discharge resistance (R) and the output capacitor (C_L). By setting time constant of a C_L auto-discharge resistance value [R_{DCHG}] and an output capacitor value (C_L) as τ ($\tau = C \times R_{DCHG}$), the output voltage after discharge via the N channel transistor is calculated by the following formulas.

$$V = V_{OUT(E)} \times e^{-t/\tau}, \text{ or } t = \tau \ln (V_{OUT(E)} / V)$$

(V: Output voltage after discharge, V_{OUT(E)}: Output voltage, t: Discharge time,
 τ : C_L auto-discharge resistance R_{DCHG} × Output capacitor (C_L) value C)

<Current Limiter, Short-Circuit Protection>

The XC6217 series' foldback circuit operates as an output current limiter and a short protection of the output pin. When the load current reaches the current limit level, the fixed current limiter circuit operates and output voltage drops. As a result of this drop in output voltage, the foldback circuit operates, output voltage drops further and output current decreases. When the output pin is shorted to the V_{SS} level, a current of about 30mA flows.

<CE Pin>

The IC's internal circuitry can be shutdown via the signal from the CE pin with the XC6217 series. In shutdown mode, output at the V_{OUT} pin will be pulled down to the V_{SS} level via R1 & R2. However, as for the XC6217 series B/D type, the C_L auto-discharge resistor is connected in parallel to R1 and R2 while the power supply is applied to the V_{IN} pin. Therefore, time until the V_{OUT} pin reaches the V_{SS} level becomes short. The output voltage becomes unstable, when the CE pin is open. Please input a certain voltage within an electrical characteristic into CE pin.

If this IC is used with the correct output voltage for the CE pin, the logic is fixed and the IC will operate normally. However, supply current may increase as a result of through current in the IC's internal circuitry when medium voltage is input.

■ NOTES ON USE

1. Please use this IC within the stated absolute maximum ratings. The IC is liable to malfunction should the ratings be exceeded.
2. Where wiring impedance is high, operations may become unstable due to noise and/or phase lag depending on output current. Please strengthen V_{IN} and V_{SS} wiring in particular.
3. Please wire the input capacitor (C_{IN}) and the output capacitor (C_L) as close to the IC as possible.
4. Capacitances of these capacitors (C_{IN}, C_L) are decreased by the influences of bias voltage and ambient temperature. Care shall be taken for capacitor selection to ensure stability of phase compensation from the point of ESR influence.
5. When the IC is used under the condition of very small dropout voltage, an output may carry out unstable operation. Please use it after evaluating enough under the conditions to be used.
6. Torex places an importance on improving our products and their reliability.

We request that users incorporate fail-safe designs and post-aging protection treatment when using Torex products in their systems.

TEST CIRCUITS

Circuit 1: Output Voltage, Output Current, Dropout Voltage, Input/Operating Voltage, Line Regulation, Load Regulation, Current Limit, Short Current, C_L Discharge Resistance



*No GO pin with the XC6217C/D type.

Circuit 2: Supply Current, Standby Current

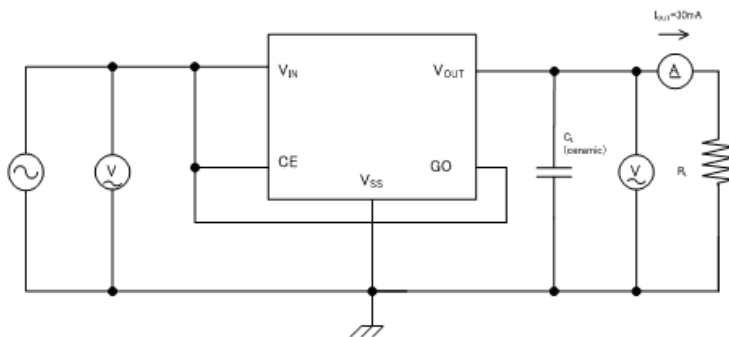

*No GO pin with the XC6217C/D type.

Circuit 3: Ripple Rejection Rate



*No GO pin with the XC6217C/D type.

Circuit 4: Supply Current, HS/PS Switching Current, PS Switching Delay Time, CE/GO "H" "L" Level Voltage, CE/GO "H" "L" Level Current



*No GO pin with the XC6217C/D type.

TYPICAL PERFORMANCE CHARACTERISTICS

(1) Output Voltage vs. Output Current



(2) Output Voltage vs. Input Voltage

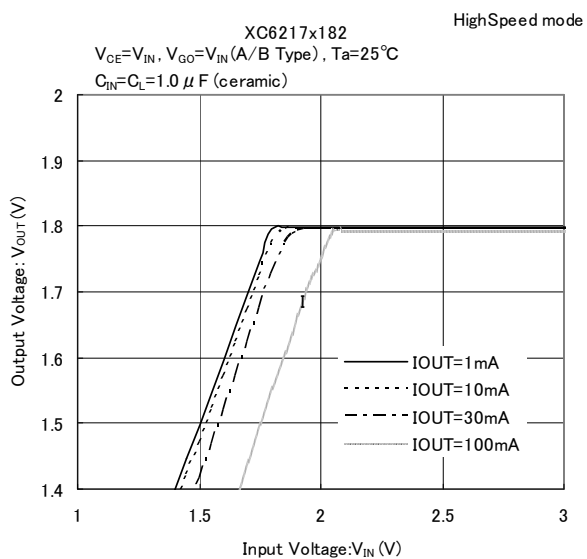

TYPICAL PERFORMANCE CHARACTERISTICS (Continued)

(2) Output Voltage vs. Input Voltage (Continued)



(3) Dropout Voltage vs. Output Current

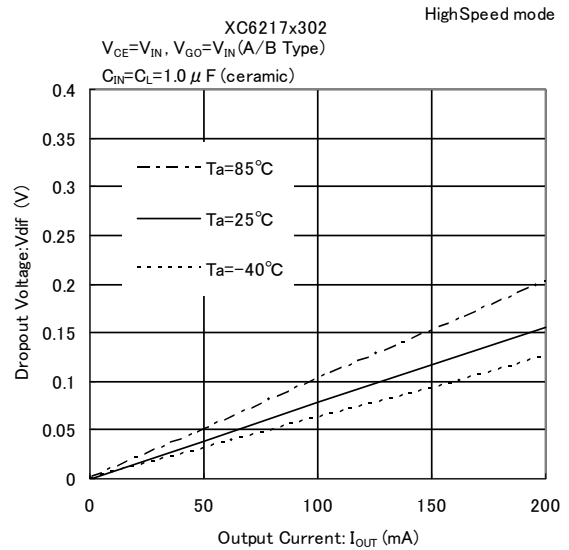

(4) Output Voltage vs. Ambient Temperature

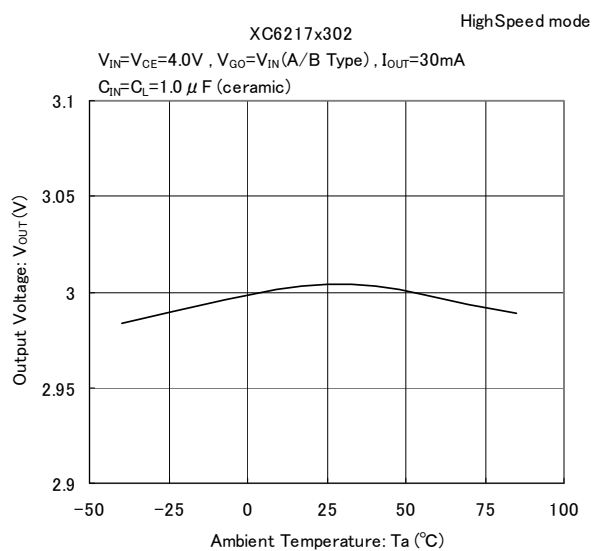
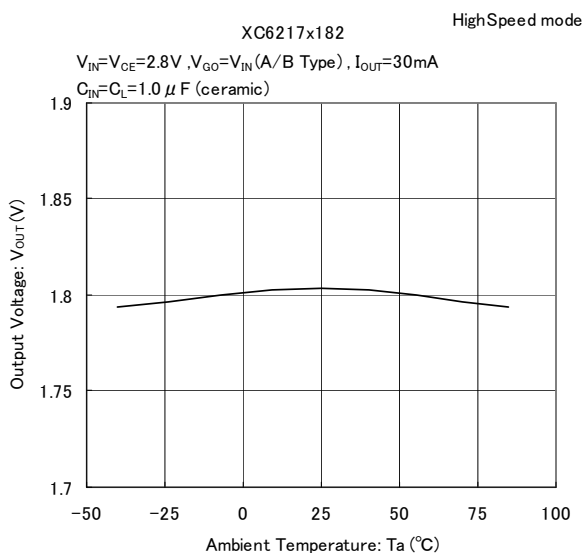

TYPICAL PERFORMANCE CHARACTERISTICS (Continued)

(5) Supply Current vs. Input Voltage



(6) PS Switching Delay Time vs. Ambient Temperature

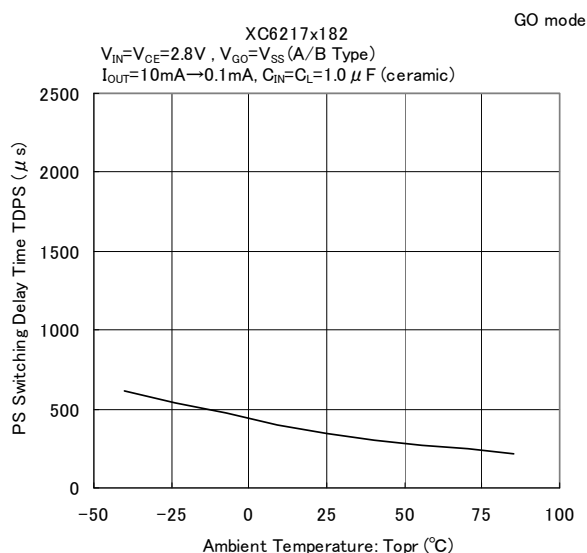

TYPICAL PERFORMANCE CHARACTERISTICS (Continued)

(7) CL Auto-Discharge Resistance vs. Ambient



(8) PS/HS Switching Current vs. Ambient Temperature



(9) Load Transient Response

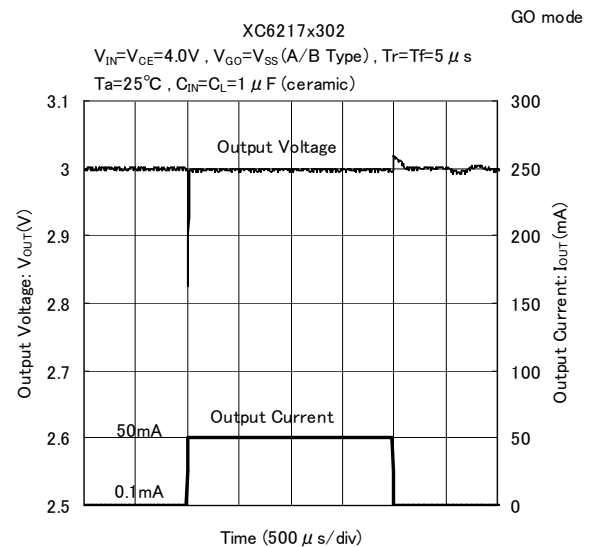

■ TYPICAL PERFORMANCE CHARACTERISTICS (Continued)

(9) Load Transient Response



(10) Line Transient Response

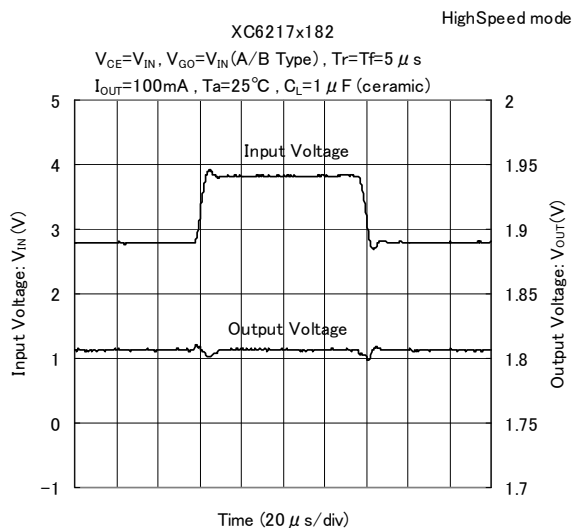

TYPICAL PERFORMANCE CHARACTERISTICS (Continued)

(10) Line Transient Response

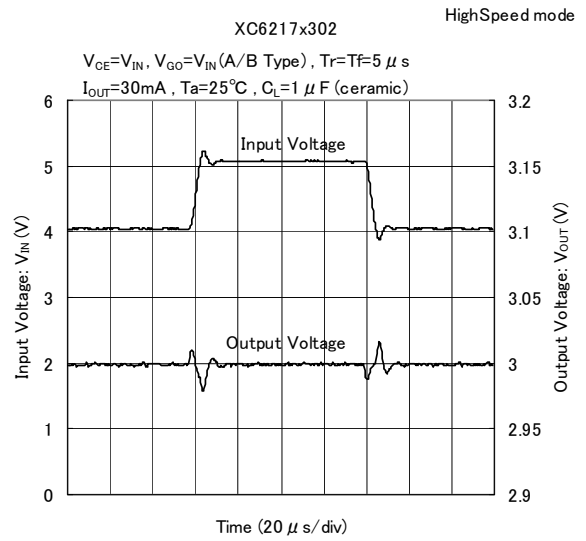

(11) Turn-On Response



■ TYPICAL PERFORMANCE CHARACTERISTICS (Continued)

(11) Turn-On Response (Continued)

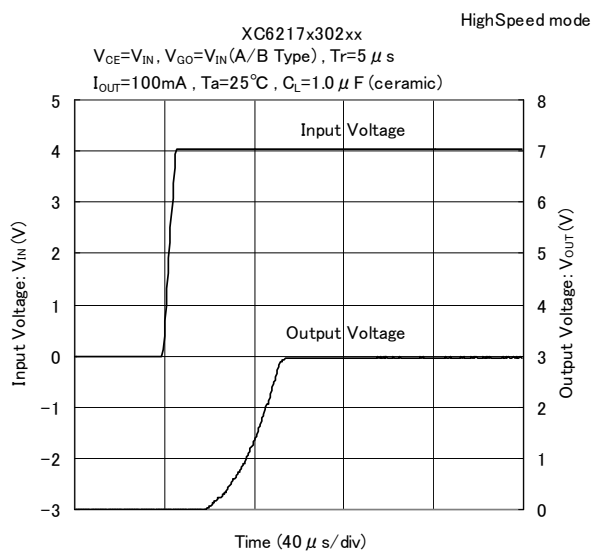
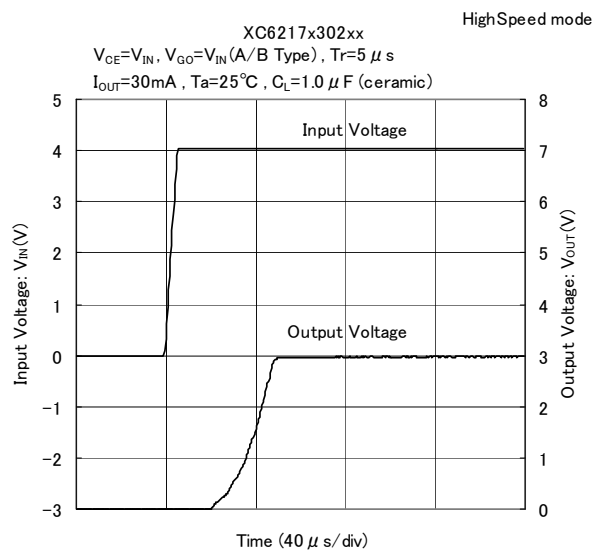
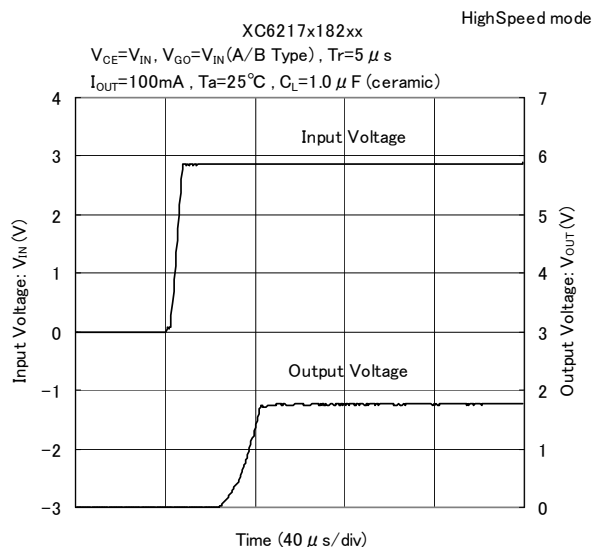

(12) CE Turn-On Response

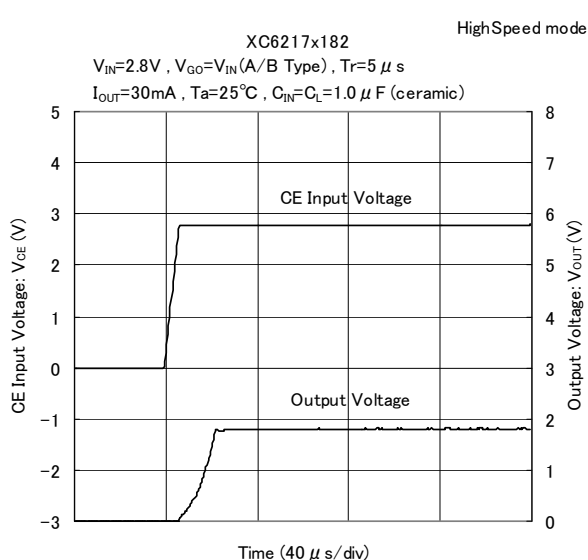
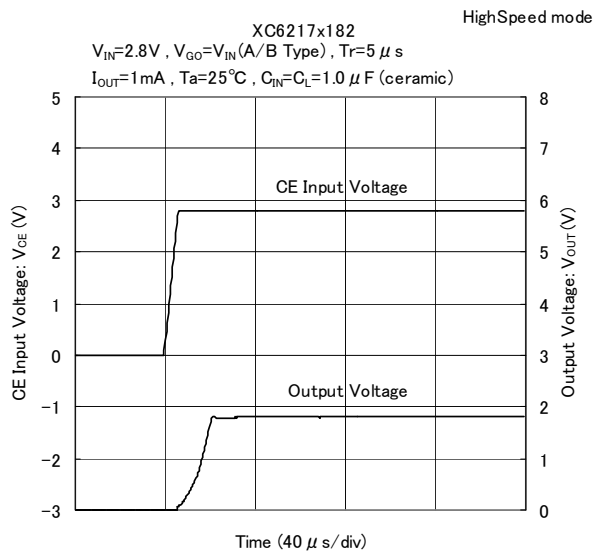

TYPICAL PERFORMANCE CHARACTERISTICS (Continued)

(12) CE Turn-On Response (Continued)



■ TYPICAL PERFORMANCE CHARACTERISTICS (Continued)

(13) Ripple Rejection Rate

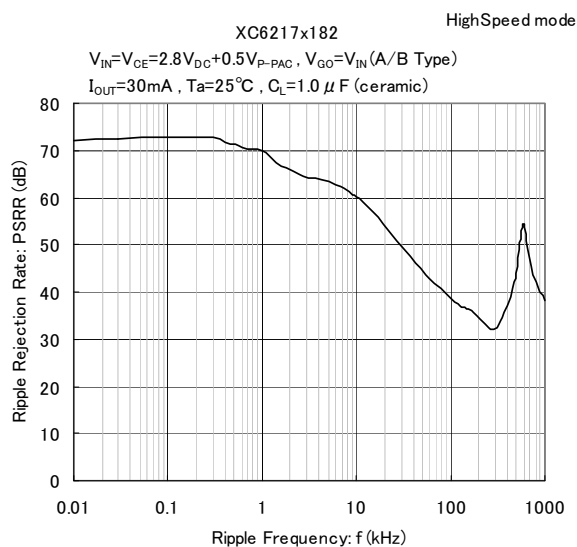

PACKAGING INFORMATION

● USP-4D

(unit : mm)



● SOT-25

(unit : mm)



*Soldering fillet surface is not formed because the sides of the pins

● SSOT-24

(unit : mm)

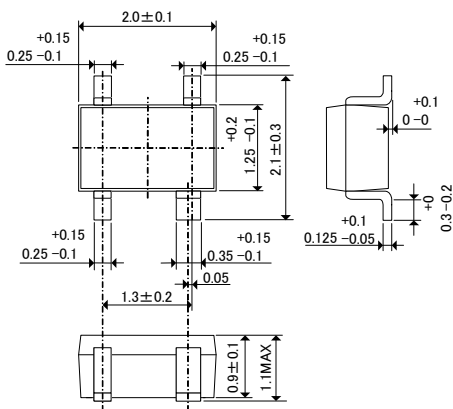

● USPN-4

(unit : mm)



■ PACKAGING INFORMATION (Continued)

● USP-4D Reference Pattern Layout Dimension (unit : mm)

● USP-4D Reference metal mask design (unit : mm)



● USPN-4 Reference Pattern Layout Dimension (unit : mm)

● USPN-4 Reference metal mask design (unit : mm)

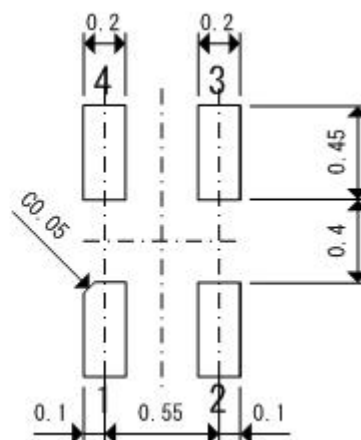

●USP4D Power Dissipation (40mm x 40mm Standard board)

Power dissipation data for the USP4D is shown in this page.

The value of power dissipation varies with the mount board conditions.

Please use this data as the reference data taken in the following condition.

1. Measurement Condition

Condition : Mount on a board

Ambient : Natural convection

Soldering : Lead (Pb) free

Board : Dimensions 40 x 40 mm

(1600 mm² in one side)

Copper (Cu) traces occupy 50% of the board

area in top and back faces

Package heat-sink is tied to the copper traces

Material : Glass Epoxy (FR-4)

Thickness : 1.6mm

Through-hole : 4 x 0.8 Diameter

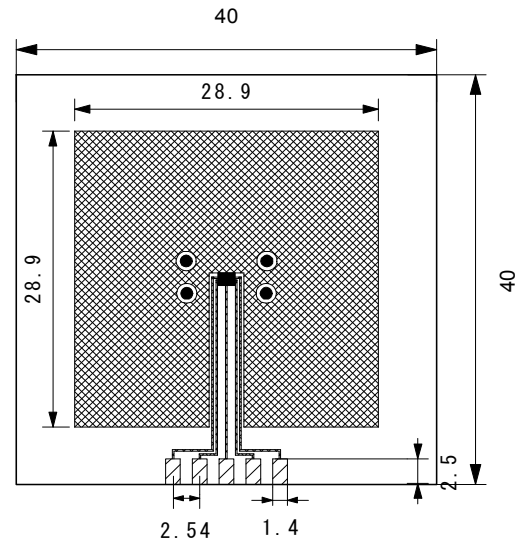

Evaluation Board (Unit: mm)

2. Power Dissipation vs. Ambient Temperature

Board Mount ($T_j \text{ max} = 125^\circ\text{C}$)

Ambient Temperature ($^\circ\text{C}$)	Power Dissipation Pd (mW)	Thermal Resistance ($^\circ\text{C}/\text{W}$)
25	650	153.85
85	260	



●USPN-4 Power Dissipation (40mm x 40mm Standard board)

Power dissipation data for the USPN-4 is shown in this page.

The value of power dissipation varies with the mount board conditions.

Please use this data as the reference data taken in the following condition.

1. Measurement Condition

Condition : Mount on a board

Ambient : Natural convection

Soldering : Lead (Pb) free

Board: Dimensions 40 x 40 mm
(1600 mm² in one side)

Copper (Cu) traces occupy 50% of the front and 50% of the back.

The copper area is divided into four block, one block is 12.5% of total.

The USPN-4 package has for terminals.

Each terminal connects one copper block in the front and one in the back.

Material: Glass Epoxy (FR-4)

Thickness: 1.6 mm

Through-hole: 4 x 0.8 Diameter



Evaluation Board (Unit: mm)

2. Power Dissipation vs. Ambient Temperature

Board Mount (T_j max = 125°C)

Ambient Temperature (°C)	Power Dissipation Pd (mW)	Thermal Resistance (°C/W)
25	600	166.67
85	240	

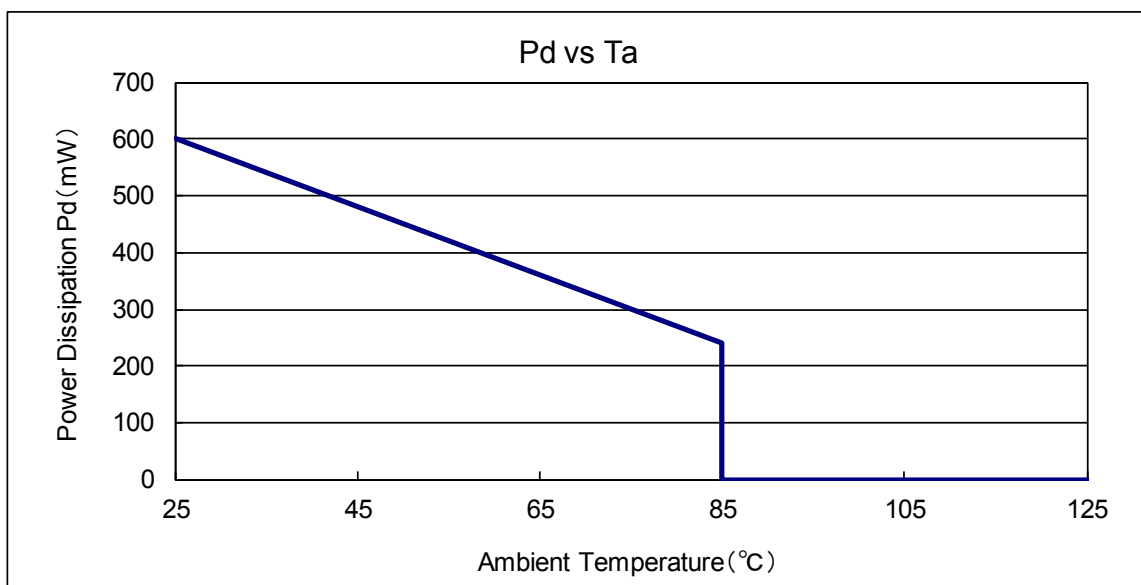

● SSOT-24 Power Dissipation(40mm x 40mm Standard board)

Power dissipation data for the SSOT-24 is shown in this page.

The value of power dissipation varies with the mount board conditions.

Please use this data as the reference data taken in the following condition.

1. Measurement Condition

Condition : Mount on a board

Ambient : Natural convection

Soldering : Lead (Pb) free

Board : Dimensions 40 x 40 mm
(1600 mm² in one side)

Copper (Cu) traces occupy 50% of the board
area in top and back faces

Package heat-sink is tied to the copper traces

Material : Glass Epoxy (FR-4)

Thickness : 1.6mm

Through-hole : 4 x 0.8 Diameter



Evaluation Board (Unit: mm)

2. Power Dissipation vs. Ambient Temperature

Board Mount (T_j max = 125°C)

Ambient Temperature (°C)	Power Dissipation Pd (mW)	Thermal Resistance (°C/W)
25	500	200.00
85	200	



● SOT-25 Power Dissipation (40mm x 40mm Standard board)

Power dissipation data for the SOT-25 is shown in this page.
The value of power dissipation varies with the mount board conditions.
Please use this data as the reference data taken in the following condition.

1. Measurement Condition

- Condition: Mount on a board
- Ambient: Natural convection
- Soldering: Lead (Pb) free
- Board: Dimensions 40 x 40 mm
(1600 mm² in one side)
- Copper (Cu) traces occupy 50% of the board area in top and back faces
- Package heat-sink is tied to the copper traces
(Board of SOT-26 is used.)
- Material: Glass Epoxy (FR-4)
- Thickness: 1.6mm
- Through-hole: 4 x 0.8 Diameter



Evaluation Board (Unit: mm)

2. Power Dissipation vs. Ambient Temperature

Board Mount (T_j max = 125°C)

Ambient Temperature (°C)	Power Dissipation Pd (mW)	Thermal Resistance (°C/W)
25	600	166.67
85	240	



MARKING RULE

● SOT-25



SOT-25
(TOP VIEW)

① represents product series

MARK	PRODUCT SERIES
1	XC6217xxxxxx

② represents type of regulators

MARK				PRODUCT SERIES
OUTPUT VOLTAGE 0.1V INCREMENTS		OUTPUT VOLTAGE 0.05V INCREMENTS		
0.80V~3.00V	3.10V~4.00V	0.85V~3.05V	3.15V~3.95V	
V	A	E	L	XC6217Axxxxx
X	B	F	M	XC6217Bxxxxx

□ represents output voltage numbers after the decimal point.

③ represents output voltage

MARK	OUTPUT VOLTAGE (V)				MARK	OUTPUT VOLTAGE (V)			
0	-	3.10	-	3.15	F	1.60	-	1.65	-
1	-	3.20	-	3.25	H	1.70	-	1.75	-
2	-	3.30	-	3.35	K	1.80	-	1.85	-
3	-	3.40	-	3.45	L	1.90	-	1.95	-
4	-	3.50	-	3.55	M	2.00	-	2.05	-
5	-	3.60	-	3.65	N	2.10	-	2.15	-
6	-	3.70	-	3.75	P	2.20	-	2.25	-
7	0.80	3.80	0.85	3.85	R	2.30	-	2.35	-
8	0.90	3.90	0.95	3.95	S	2.40	-	2.45	-
9	1.00	4.00	1.05	-	T	2.50	-	2.55	-
A	1.10	-	1.15	-	U	2.60	-	2.65	-
B	1.20	-	1.25	-	V	2.70	-	2.75	-
C	1.30	-	1.35	-	X	2.80	-	2.85	-
D	1.40	-	1.45	-	Y	2.90	-	2.95	-
E	1.50	-	1.55	-	Z	3.00	-	3.05	-

① represents type of regulators and output voltage range

SSOT-24
(TOP VIEW)

② represents output voltage numbers after the decimal point.

MARK	OUTPUT VOLTAGE (V)				MARK	OUTPUT VOLTAGE (V)			
0	-	3.10	-	3.15	F	1.60	-	1.65	-
1	-	3.20	-	3.25	H	1.70	-	1.75	-
2	-	3.30	-	3.35	K	1.80	-	1.85	-
3	-	3.40	-	3.45	L	1.90	-	1.95	-
4	-	3.50	-	3.55	M	2.00	-	2.05	-
5	-	3.60	-	3.65	N	2.10	-	2.15	-
6	-	3.70	-	3.75	P	2.20	-	2.25	-
7	0.80	3.80	0.85	3.85	R	2.30	-	2.35	-
8	0.90	3.90	0.95	3.95	S	2.40	-	2.45	-
9	1.00	4.00	1.05	-	T	2.50	-	2.55	-
A	1.10	-	1.15	-	U	2.60	-	2.65	-
B	1.20	-	1.25	-	V	2.70	-	2.75	-
C	1.30	-	1.35	-	X	2.80	-	2.85	-
D	1.40	1.45	1.50	1.55	Y	2.90	-	2.95	-
E	1.60	1.65	1.70	1.75	Z	3.00	-	3.05	-
0.80V~3.0V		3.10V~4.00V		0.85V~3.05V		3.15V~3.95V		PRODUCT SERIES	
③④ represents production lot number		2		6		XC6217Cxxxx			
01~09, 0A~0Z, 11~19Z, A1~A9, AA~AZ, ZA~ZZ in order.		3		8		XC6217Dxxxx			

■ MARKING RULE (Continued)

● SSOT-24



④⑤ represents production lot number

01~09, 0A~0Z, 11~19Z, A1~A9, AA~AZ, ZA~ZZ in order.

(G, I, J, O, Q, W excluded) Note: No character inversion used.

MARKING RULE (Continued)

● USP-4D



USP-4D
(TOP VIEW)

① represents product series

MARK	PRODUCT SERIES
1	XC6217xxxxxx

② represents type of regulators

③ represents integer number of output voltage
ex.)

④ represents output voltage numbers after the decimal point.

MARK	TYPE OF REGULATORS	PRODUCT SERIES
A	CE High Active, without CL-Discharge	XC6217Axxxxx
B	CE High Active, with CL-Discharge	XC6217Bxxxxx

MARK	VOLTAGE (V)	PRODUCT SERIES
3	3.X	XC6217x3xxGx
5	5.X	XC6217x5xxGx

MARK	VOLTAGE(V)	PRODUCT SEIRES	MARK	VOLTAGE (V)	PRODUCT SEIRES
0	X.0	XC6217xx02/1Gx	A	x.05	XC6217xx0A/1Gx
1	X.1	XC6217xx12/1Gx	B	x.15	XC6217xx1A/1Gx
2	X.2	XC6217xx22/1Gx	C	x.25	XC6217xx2A/1Gx
3	X.3	XC6217xx32/1Gx	D	x.35	XC6217xx3A/1Gx
4	X.4	XC6217xx42/1Gx	E	x.45	XC6217xx4A/1Gx
5	X.5	XC6217xx52/1Gx	F	x.55	XC6217xx5A/1Gx
6	X.6	XC6217xx62/1Gx	H	x.65	XC6217xx6A/1Gx
7	X.7	XC6217xx72/1Gx	K	x.75	XC6217xx7A/1Gx
8	X.8	XC6217xx82/1Gx	L	x.85	XC6217xx8A/1Gx
9	X.9	XC6217xx92/1Gx	M	x.95	XC6217xx9A/1Gx

⑤⑥ represents production lot number
01~09, 0A~0Z, 11~19, A1~A9, AA~AZ, ZA~ZZ in order.
(G, I, J, O, Q, W excluded) Note: No character inversion used.

MARKING RULE (Continued)

●USPN-4



USPN-4
(TOP
VIEW)

① represents type of regulators and output voltage range

MARK				PRODUCT SERIES
OUTPUT VOLTAGE 0.10V INCREMENTS		OUTPUT VOLTAGE 0.05V INCREMENTS		
0.80V~3.00V	3.10V~4.00V	0.85V~3.05V	3.15V~3.95V	
1	5	2	6	XC6217Cxxxxx
3	7	4	8	XC6217Dxxxxx

② represents output voltage numbers after the decimal point.

MARK	OUTPUT VOLTAGE (V)				MARK	OUTPUT VOLTAGE (V)			
0	-	3.10	-	3.15	F	1.60	-	1.65	-
1	-	3.20	-	3.25	H	1.70	-	1.75	-
2	-	3.30	-	3.35	K	1.80	-	1.85	-
3	-	3.40	-	3.45	L	1.90	-	1.95	-
4	-	3.50	-	3.55	M	2.00	-	2.05	-
5	-	3.60	-	3.65	N	2.10	-	2.15	-
6	-	3.70	-	3.75	P	2.20	-	2.25	-
7	0.80	3.80	0.85	3.85	R	2.30	-	2.35	-
8	0.90	3.90	0.95	3.95	S	2.40	-	2.45	-
9	1.00	4.00	1.05	-	T	2.50	-	2.55	-
A	1.10	-	1.15	-	U	2.60	-	2.65	-
B	1.20	-	1.25	-	V	2.70	-	2.75	-
C	1.30	-	1.35	-	X	2.80	-	2.85	-
D	1.40	-	1.45	-	Y	2.90	-	2.95	-
E	1.50	-	1.55	-	Z	3.00	-	3.05	-

*USPN-4 $0.80V \leq V_{OUT(T)} \leq 1.55V$ underdevelopment.

③ represents production lot number

1 to 9, A to Z, repeated. (G, I, J, O, Q, W excluded)



Note: No character inversion used.

1. The product and product specifications contained herein are subject to change without notice to improve performance characteristics. Consult us, or our representatives before use, to confirm that the information in this datasheet is up to date.
2. The information in this datasheet is intended to illustrate the operation and characteristics of our products. We neither make warranties or representations with respect to the accuracy or completeness of the information contained in this datasheet nor grant any license to any intellectual property rights of ours or any third party concerning with the information in this datasheet.
3. Applicable export control laws and regulations should be complied and the procedures required by such laws and regulations should also be followed, when the product or any information contained in this datasheet is exported.
4. The product is neither intended nor warranted for use in equipment of systems which require extremely high levels of quality and/or reliability and/or a malfunction or failure which may cause loss of human life, bodily injury, serious property damage including but not limited to devices or equipment used in 1) nuclear facilities, 2) aerospace industry, 3) medical facilities, 4) automobile industry and other transportation industry and 5) safety devices and safety equipment to control combustions and explosions. Do not use the product for the above use unless agreed by us in writing in advance.
5. Although we make continuous efforts to improve the quality and reliability of our products; nevertheless Semiconductors are likely to fail with a certain probability. So in order to prevent personal injury and/or property damage resulting from such failure, customers are required to incorporate adequate safety measures in their designs, such as system fail safes, redundancy and fire prevention features.
6. Our products are not designed to be Radiation-resistant.
7. Please use the product listed in this datasheet within the specified ranges.
8. We assume no responsibility for damage or loss due to abnormal use.
9. All rights reserved. No part of this datasheet may be copied or reproduced unless agreed by Torex Semiconductor Ltd in writing in advance.

TOREX SEMICONDUCTOR LTD.

Looking for pricing, stock, or lifecycle information?

Click below to explore more details on WIN SOURCE:

-  [View XC6217A282GRN on WIN SOURCE](#)
-  [Torex Semiconductor Ltd Information](#)

Optimize Your Supply Chain with WIN SOURCE Solutions

-  Global Sourcing Solution
-  Obsolete Management
-  Cost Control Management
-  Shortage Management
-  Alternative Solution
-  Excess Inventory Management