



**THE DATASHEET OF
XC6219B332MR**



■ Product introduction

XC6219 series is a high precision, low noise and fast response low dropout linear voltage regulator manufactured by CMOS process. This series of voltage regulators has built-in fixed reference voltage, error correction circuit, current limiting circuit, phase compensation circuit and MOSFET with low internal resistance, which achieves high ripple suppression, low output noise and quick response to low dropout.

XC6219 series is compatible with ceramic capacitors with smaller volume than tantalum capacitors, and does not need to use 0.1 μF By-pass capacitors, which can save space and reduce cost. Because of its high-precision output stability and fast transient response, it can cope with the fluctuation of load current, so it is especially suitable for handheld devices and RF products.

By controlling the CE pin on the chip, the output can be turned off, and the static current after turning off the output is only 0.1uA(Typ value), thus greatly reducing the power consumption.

■ Product features

- High precision output voltage: 2.0%;
- Selectable output voltage: 1.8V~5.0V;
- Very low static current (Typ.=15μ A);
- Very low turn-off current (Typ.=0.1 μ A);
- Good input stability: Typ.=0.2%/V;
- Strong carrying capacity:when Vin=4.3V and Vout=3.3V, Iout=300mA
- Built-in overcurrent protection and load short circuit protection;
- Compatible ceramic capacitor;
- Package form: SOT89-5, SOT23-5

■ product usage

- Smart phone/mobile phone
- Bluetooth and other RF products
- Digital camera/video camera
- Portable consumer equipment
- Battery powered equipment

■ Package form and pin definition function

Pin serial number		Pin definition	function declaration
MR package	PR package		
SOT23-3	SOT89-3		
1	4	VIN	Input
2	2	VSS	Grounding terminal
3	3	CE	Enable side
4	1	NC	empty
5	5	VOUT	Output

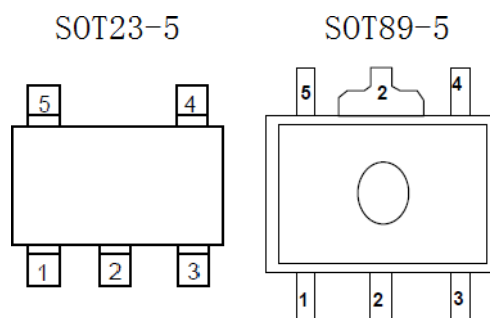

■ functional block diagram

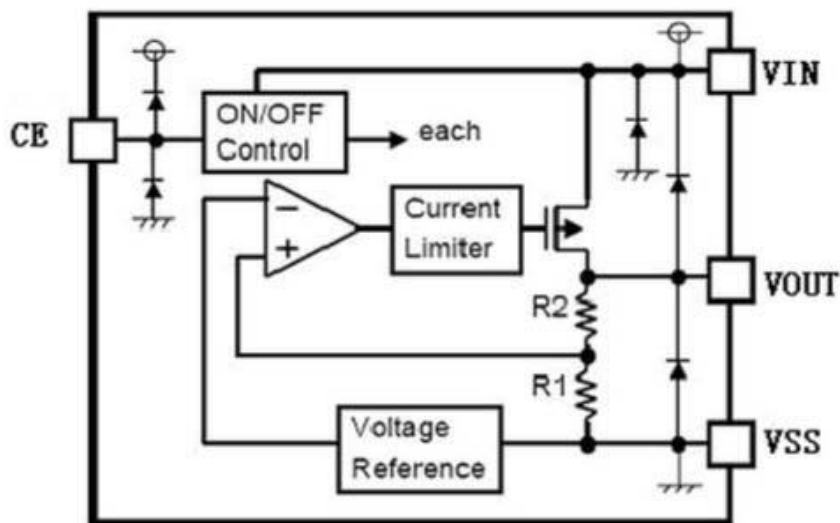

■ Limit parameter

project	symbol	explain		limit value	unit
voltage	Vin	input voltage		9	V
	Vout	Output voltage		Vss-0.3~ Vin+0.3	V
electric current	Iout	output current		500	mA
Power Consumption	PD	SOT23-5	Maximum allowable power consumption	200	mW
		SOT89-5		300	
Temperature	T _{OPR}	Working temperature		- 20~ +60	°C
	T _{stg}	Storage temperature		- 40~ +125	°C
	T _{solder}	welding temperature		260°C, 10s	

Note: The limit parameter refers to the limit value that can't be exceeded under any conditions. If it exceeds this limit value, it may cause physical damage such as product deterioration; At the same time, when the parameters are close to the limit, the chip can't work normally.

■ Typical application

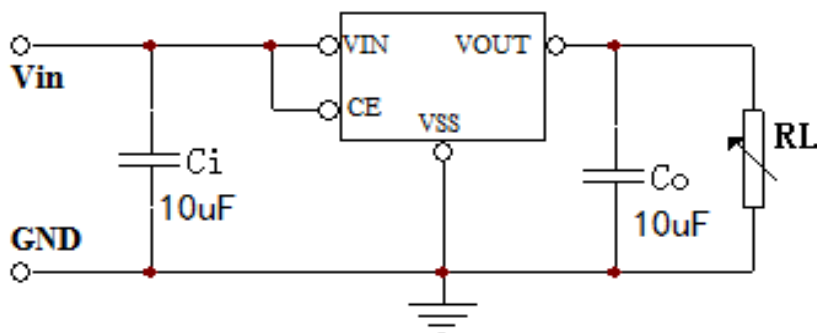

Electrical characteristics

 XC6219 $V_{OUT}(T)=3.3V$ ($C_i=C_o=10\mu F, T_a=25^\circ C$ unless otherwise specified)

trait	symbol	test condition	minimum value	typical value	maximum	unit
Output voltage	$V_{OUT}(E)$	$I_{OUT}=1mA, V_{IN}=5V, V_{CE}=1.6V$	3.24	3.300	3.360	V
Maximum output current	$I_{OUT}(\max)$	$V_{IN}=4.3V$	300			mA
Load stability	ΔV_{OUT}	$V_{IN}=V_{CE}=4.3V, 1mA \leq I_{OUT} \leq 100mA$		12		mV
Input stability	$\Delta V_{OUT}/(\Delta V_{IN} \bullet V_{OUT})$	$I_{OUT}=10mA, 4.3V \leq V_{IN} \leq 7V$		0.2		%/V
Drop pressure difference	V_{drop1}	$V_{IN}=4.3V, I_{OUT}=10mA$		35		mV
	V_{drop2}	$V_{IN}=4.3V, I_{OUT}=100mA$		280		mV
quiescent current	I_{SS1}	$V_{IN}=V_{CE}=5V$	—	15	—	μA
	I_{SS2}	$V_{IN}=5V, V_{CE}=V_{SS}$			0.5	μA
CE input voltage	V_{CEH}		1.6		V_{IN}	V
	V_{CEL}		0		0.5	V
CE input current	I_{CE}	$V_{CE}=0V$ to V_{IN}			0.5	μA
Ripple suppression ratio	PSRR	$V_{IN}=V_{CE}=4.3V+1V_{p-pAC}, I_{OUT}=10mA, f=1kHz$		40		dB
Output voltage temperature coefficient	$\Delta V_{OUT}/(\Delta T_a \bullet V_{OUT})$	$V_{IN}=V_{CE}=4.3V, I_{OUT}=3.3mA, 0^\circ C \leq T_a \leq 60^\circ C$		± 290		ppm/ $^\circ C$
input voltage	V_{IN}		1.8		7	V

Note:

- $V_{OUT}(T)$: the specified output voltage.
- $V_{OUT}(E)$: effective output voltage.
- $I_{OUT}(\max)$: slowly increase the output current, and the current value when the output voltage is $\leq V_{OUT}(E) \cdot 95\%$.
- $V_{drop} = V_{IN1} - V_{OUT}(E)$
 V_{IN1} = gradually reduce the input voltage, and the input voltage when the output voltage drops to 98% of $V_{OUT}(E)$.
 $V_{OUT}(E)_{98} = V_{OUT}(E) \cdot 98\%$
 $V_{OUT}(E)_{98}$ = the output voltage value when $V_{IN} = V_{OUT}(T) + 1V$ and I_{out} = a certain value.

■ Characteristic curve (3.3V output)

1. Output voltage and output current

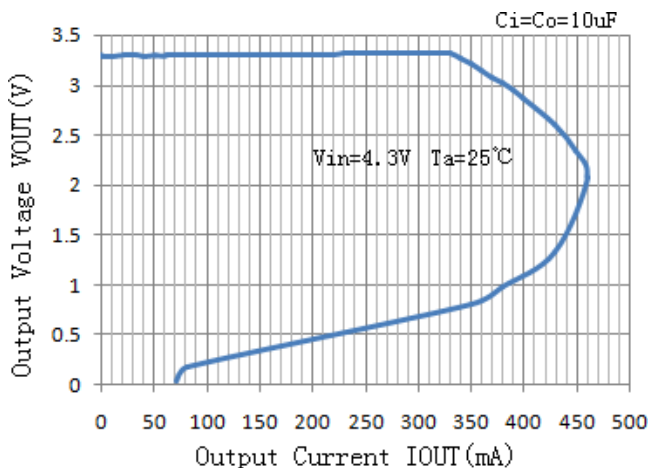

2. Output voltage and input voltage

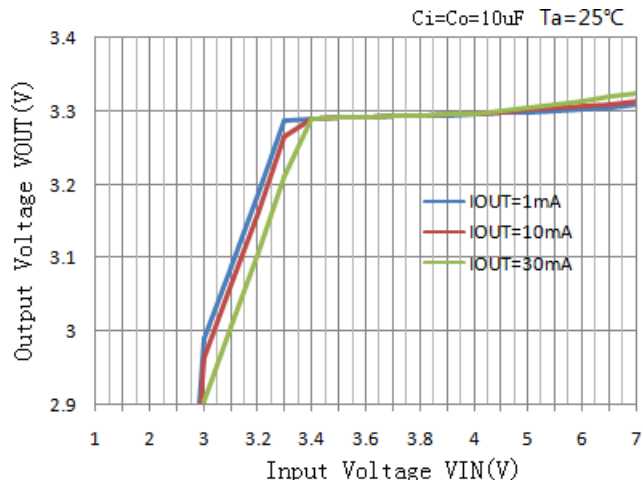

3. Dropout voltage and output current

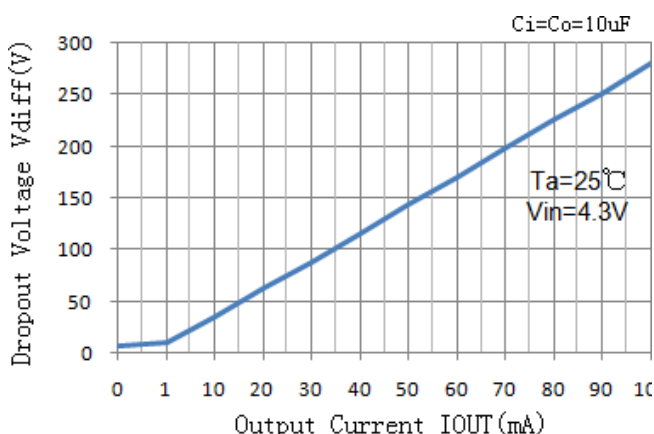

4. Input voltage and static current

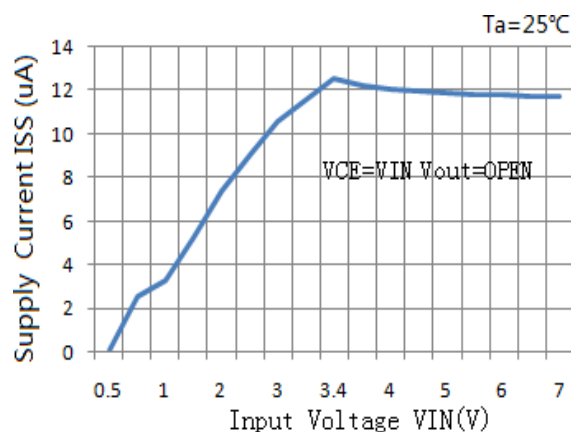

5. Ripple suppression

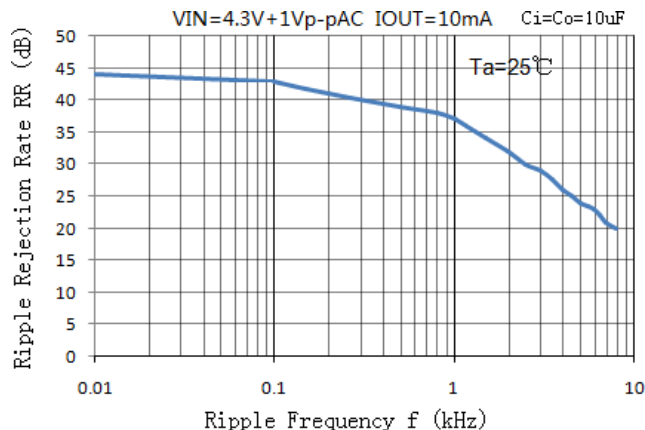

6. Output voltage and temperature

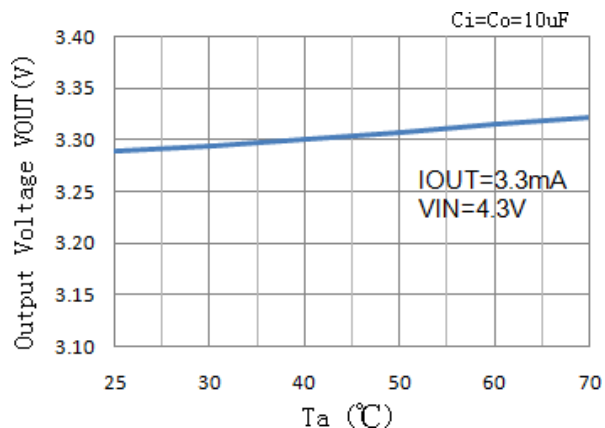

■ Package Information

SOT23-5

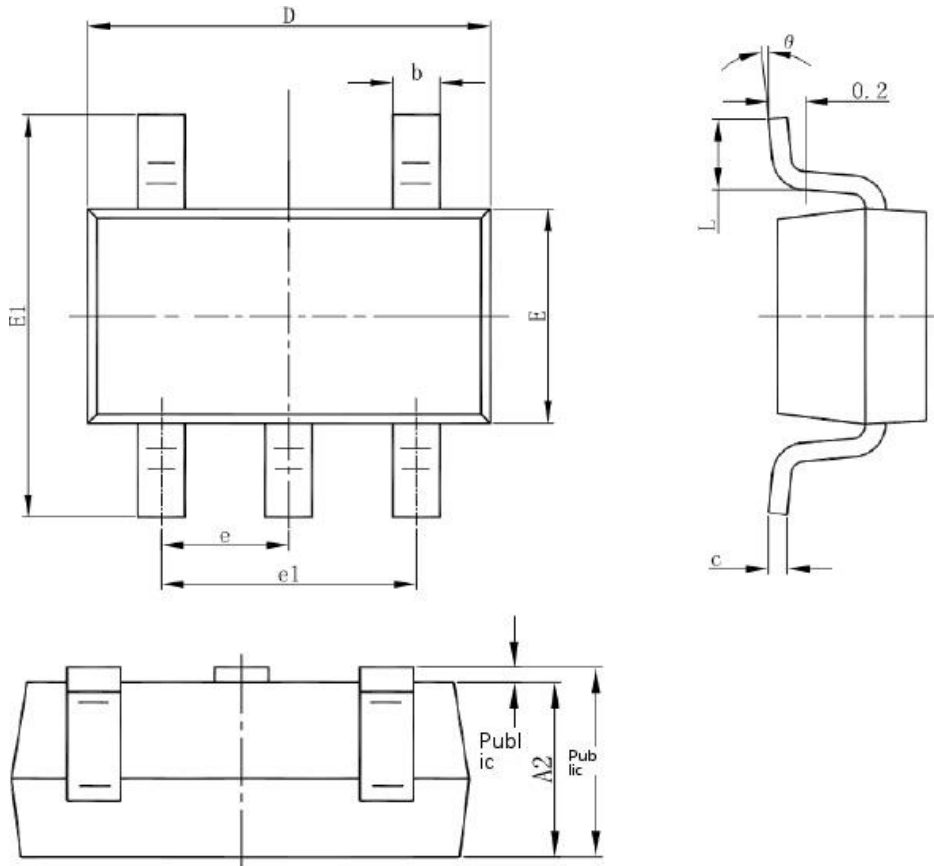

Symbol	Dimensions In Millimeters		Dimensions In Inches	
	Min	Max	Min	Max
A	1.050	1.250	0.041	0.049
A1	0.000	0.100	0.000	0.004
A2	1.050	1.150	0.041	0.045
b	0.300	0.500	0.012	0.020
c	0.100	0.200	0.004	0.008
D	2.820	3.020	0.111	0.119
E	1.500	1.700	0.059	0.067
E1	2.650	2.950	0.104	0.116
e	0.950(BSC)		0.037(BSC)	
e1	1.800	2.000	0.071	0.079
L	0.300	0.600	0.012	0.024
θ	0°	8°	0°	8°

SOT89-5

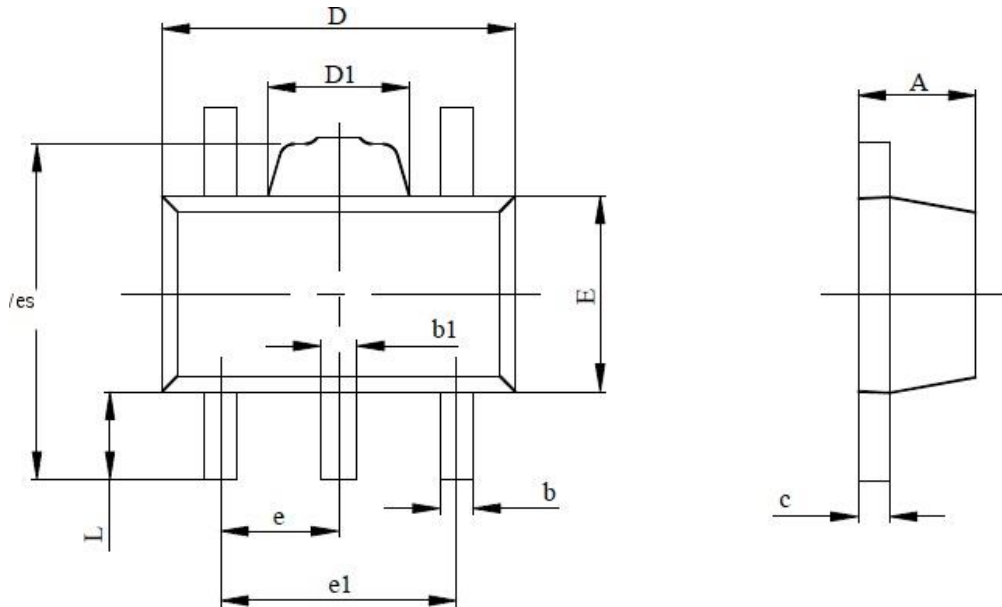

SYMBOL	MILLIMETERS		INCHES	
	MIN	MAX	MIN	MAX
A	1.400	1.600	0.055	0.063
b	0.320	0.520	0.013	0.020
b1	0.360	0.560	0.014	0.022
c	0.350	0.440	0.014	0.017
D	4.400	4.600	0.173	0.181
D1	1.400	1.800	0.055	0.071
E	2.300	2.600	0.091	0.102
E1	3.940	4.250	0.155	0.167
e	1.500 TYP.		0.060 TYP.	
e1	2.900	3.100	0.114	0.122
L	0.900	1.100	0.035	0.043







Looking for pricing, stock, or lifecycle information?

Click below to explore more details on WIN SOURCE:

 [View XC6219B332MR on WIN SOURCE](#)

 [NXP / Nexperia Information](#)

Optimize Your Supply Chain with WIN SOURCE Solutions

-  Global Sourcing Solution
-  Obsolete Management
-  Cost Control Management
-  Shortage Management
-  Alternative Solution
-  Excess Inventory Management