



**THE DATASHEET OF  
XC6219D252MR**



## 300mA High Speed LDO Regulators with ON/OFF Switch

### ■ GENERAL DESCRIPTION

The XC6219 series are highly accurate, low noise, CMOS LDO Voltage Regulators. Offering low output noise, high ripple rejection ratio, low dropout and very fast turn-on times, the XC6219 series is ideal for today's cutting edge mobile phone. Internally the XC6219/XC6211 includes a reference voltage source, error amplifiers, driver transistors, current limiters and phase compensators. The XC6219/XC6211's current limiters' foldback circuit also operates as a short protect for the output current limiter and the output pin. The output voltage is set by laser trimming. Voltages are selectable in 50mV steps within a range of 0.9V to 5.0V. The XC6219 series is also fully compatible with low ESR ceramic capacitors, reducing cost and improving output stability. This high level of output stability is maintained even during frequent load fluctuations, due to the excellent transient response performance and high PSRR achieved across a broad range of frequencies. The CE function allows the output of regulator to be turned off, resulting in greatly reduced power consumption.

### ■ APPLICATIONS

- Smart phones / Mobile phones
- Portable games
- Digital still cameras / Camcorders
- Reference voltage sources
- Multi-function power supplies

### ■ FEATURES

- Maximum Output Current** : 150mA ( $V_{OUT} < 1.75V$ , A~D type)  
240mA ( $V_{OUT} \geq 1.8V$ , A~D type)  
300mA ( $V_{OUT} \geq 1.3V$ , E~H type)
- Dropout Voltage** : 200mV @ 100mA
- Operating Voltage Range** : 2.0V ~ 6.0V
- Output Voltage Range** : 0.9V ~ 5.0V (0.05V steps)
- Highly Accuracy** :  $\pm 2\%$  ( $V_{OUT} > 1.5V$ )  
 $\pm 30mV$  ( $V_{OUT} \leq 1.5V$ )  
 $\pm 1\%$  ( $V_{OUT} \geq 3.0V$ )
- Low Power Consumption** : 25  $\mu A$  (TYP.)
- Standby Current** : Less than 0.1  $\mu A$  (TYP.)
- High Ripple Rejection** : 65dB @ 10kHz
- Operating Ambient Temperature** :  $-40^{\circ}C \sim 85^{\circ}C$
- Low ESR Capacitor** : Ceramic capacitor compatible
- Ultra Small Packages** : SOT-25  
SOT-89-5  
USP-6B
- Environmentally Friendly** : EU RoHS Compliant, Pb Free

### ■ TYPICAL APPLICATION CIRCUIT

- XC6219 series



SOT-25

### ■ TYPICAL PERFORMANCE CHARACTERISTICS

- Ripple Rejection Rate



## PIN CONFIGURATION



\* The dissipation pad for the USP-6B package should be solder-plated in recommended mount pattern and metal masking so as to enhance mounting strength and heat release. If the pad needs to be connected to other pins, it should be connected to the VSS pin.

## PIN ASSIGNMENT

PIN NUMBER			PIN NAME	FUNCTIONS
SOT-25	SOT-89-5	USP-6B		
1	4	1	VIN	Power Input
2	2	5	VSS	Ground
3	3	6	CE	ON / OFF Control
4	1	2, 4	NC	No Connection
5	5	3	VOUT	Output

## FUNCTION

TYPE A,E

PIN NAME	SIGNAL	STATUS
CE	L	Stand-by
	H	Active
	OPEN	Stand-by

TYPE B,F

PIN NAME	SIGNAL	STATUS
CE	L	Stand-by
	H	Active
	OPEN	Undefined state

TYPE C,G

PIN NAME	SIGNAL	STATUS
CE	L	Active
	H	Stand-by
	OPEN	Stand-by

TYPE D,H

PIN NAME	SIGNAL	STATUS
CE	L	Active
	H	Stand-by
	OPEN	Undefined state

\*If XC6219 B,D,F,H types are used with the CE pin opened, the IC goes into "Undefined state".

The CE pin voltage should be fixed in low or high for stable operation.

## ■ PRODUCT CLASSIFICATION

### ● Ordering Information

XC6219 ①②③④⑤⑥-⑦<sup>(\*)</sup>

DESIGNATOR	ITEM	SYMBOL	DESCRIPTION
①	CE Pin Logic	A	150mA, Active high, pull-down resistor built in (Semi-custom)
		B	150mA, Active high, no pull-down resistor built in (Standard)
		C	150mA, Active low, pull-up resistor built in (Semi-custom)
		D	150mA, Active low, no pull-up resistor built in (Semi-custom)
		E	300mA, Active high, pull-down resistor built in (Semi-custom)
		F	300mA, Active high, no pull-down resistor built in (Standard)
		G	300mA, Active low, pull-up resistor built in (Semi-custom)
		H	300mA, Active low, no pull-up resistor built in (Semi-custom)
②③	Output Voltage	09~50	e.g. ②=3, ③=0, → 3.0V
④	Output Voltage Accuracy	2 <sup>(*)</sup>	0.1V increments, ±2% accuracy e.g. ②=2, ③=8, ④=2 → 2.80V, ±2%
		1 <sup>(*)</sup>	0.1V increments, ±1% accuracy e.g. ②=3, ③=0, ④=1 → 3.00V, ±1%
		A <sup>(*)</sup>	0.05V increments, ±2% accuracy e.g. ②=2, ③=8, ④=A → 2.85V, ±2%
		B <sup>(*)</sup>	0.05V increments, ±1% accuracy e.g. ②=3, ③=0, ④=B → 3.05V, ±1%
⑤⑥-⑦	Packages (Order Unit)	MR-G	SOT-25 (3,000/Reel)
		PR-G	SOT-89-5 (1,000/Reel)
		DR-G	USP-6B (3,000/Reel)

<sup>(\*)</sup> The "-G" suffix denotes Halogen and Antimony free as well as being fully EU RoHS compliant.

<sup>(\*)</sup> Output voltage of the ±1% accuracy product is 3.0V or more.

<sup>(\*)</sup> Output voltage accuracy of the  $V_{OUT} \leq 1.5V$  is ±30mV.

## ■ BLOCK DIAGRAM

XC6219 series Type A,E



XC6219 series Type B,D,F,H



XC6219 series Type C,G



\*Diode inside the circuit are an ESD protection diode and a parasitic diode.

## ■ ABSOLUTE MAXIMUM RATINGS

Ta=25°C

PARAMETER		SYMBOL	RATINGS	UNITS
Input Voltage		V <sub>IN</sub>	7	V
Output Current		I <sub>OUT</sub>	500 <sup>(*)</sup>	mA
Output Voltage		V <sub>OUT</sub>	V <sub>SS</sub> - 0.3 ~ V <sub>IN</sub> + 0.3	V
CE Pin Voltage		V <sub>CE</sub>	V <sub>SS</sub> - 0.3 ~ V <sub>IN</sub> + 0.3	V
Power Dissipation	SOT-25	P <sub>d</sub>	250	mW
			600 (PCB mounted) <sup>(**)</sup>	
	SOT-89		500	
			1300 (PCB mounted) <sup>(**)</sup>	
USP-6B	120	1000 (PCB mounted) <sup>(**)</sup>		
Operating Ambient Temperature		T <sub>opr</sub>	- 40 ~ + 85	°C
Storage Temperature		T <sub>stg</sub>	- 55 ~ + 125	°C

All voltages are described based on the V<sub>SS</sub> pin.

<sup>(\*)</sup> I<sub>OUT</sub> ≤ P<sub>d</sub> / (V<sub>IN</sub> - V<sub>OUT</sub>)

<sup>(\*\*)</sup> The power dissipation figure shown is PCB mounted and is for reference only. Please refer to page 24~26 for details.

## ELECTRICAL CHARACTERISTICS

●XC6219 Type A,B

Ta=25°C

PARAMETER	SYMBOL	CONDITIONS	MIN.	TYP.	MAX.	UNITS	CIRCUIT
Output Voltage <sup>(*5)</sup> (2%)	V <sub>OUT(E)</sub> <sup>(*3)</sup>	I <sub>OUT</sub> =30mA	V <sub>OUT(T)</sub> <sup>(*2)</sup> ×0.98	V <sub>OUT(T)</sub> <sup>(*2)</sup>	V <sub>OUT(T)</sub> <sup>(*2)</sup> ×1.02	V	①
Output Voltage <sup>(*6)</sup> (1%)			V <sub>OUT(T)</sub> <sup>(*2)</sup> ×0.99	V <sub>OUT(T)</sub> <sup>(*2)</sup>	V <sub>OUT(T)</sub> <sup>(*2)</sup> ×1.01		
Maximum Output Current	I <sub>OUTMAX</sub>	0.9V ≤ V <sub>OUT(T)</sub> ≤ 1.75V	150	-	-	mA	①
		1.8V ≤ V <sub>OUT(T)</sub> ≤ 5.0V	240	-	-		
Load Regulation	ΔV <sub>OUT</sub>	1mA ≤ I <sub>OUT</sub> ≤ 100mA	-	15	50	mV	①
Dropout Voltage <sup>(*4)</sup>	V <sub>dif1</sub>	I <sub>OUT</sub> =30mA	-	E-1		mV	①
	V <sub>dif2</sub>	I <sub>OUT</sub> =100mA	-	E-2			
Supply Current (Type A)	I <sub>DD</sub>	V <sub>CE</sub> =V <sub>IN</sub> =V <sub>OUT(T)</sub> +1.0V	-	28	55	μA	②
Supply Current (Type B)		V <sub>OUT</sub> ≤ 0.95V, V <sub>IN</sub> =V <sub>CE</sub> =2.0V	-	25	50		
Stand-by Current	I <sub>STB</sub>	V <sub>IN</sub> =V <sub>OUT(T)</sub> +1.0V, V <sub>CE</sub> =V <sub>SS</sub> V <sub>OUT</sub> ≤ 0.95V, V <sub>IN</sub> =2.0V	-	0.01	0.10	μA	②
Line Regulation	ΔV <sub>OUT</sub> / (ΔV <sub>IN</sub> ·V <sub>OUT</sub> )	V <sub>OUT(T)</sub> +1.0V ≤ V <sub>IN</sub> ≤ 6.0V V <sub>OUT</sub> ≤ 0.95V, 2.0V ≤ V <sub>IN</sub> ≤ 6.0V I <sub>OUT</sub> =30mA V <sub>OUT</sub> ≤ 1.75V, I <sub>OUT</sub> =10mA	-	0.01	0.20	%/V	①
Input Voltage	V <sub>IN</sub>	-	2	-	6	V	-
Output Voltage Temperature Characteristics	ΔV <sub>OUT</sub> / (ΔT <sub>opr</sub> ·V <sub>OUT</sub> )	I <sub>OUT</sub> =30mA -40°C ≤ T <sub>opr</sub> ≤ 85°C	-	±100	-	ppm/°C	①
Power Supply Rejection Ratio	PSRR	V <sub>IN</sub> =[V <sub>OUT(T)</sub> +1.0]V+1.0V <sub>p-pAC</sub> V <sub>OUT</sub> ≤ 1.5, V <sub>IN</sub> =2.5V+1.0V <sub>p-pAC</sub> I <sub>OUT</sub> =50mA, f=10kHz	-	E-3	-	dB	④
Current Limiter	I <sub>lim</sub>	V <sub>IN</sub> =V <sub>OUT(T)</sub> +2.0V, V <sub>CE</sub> =V <sub>IN</sub> 0.9V ≤ V <sub>OUT(T)</sub> ≤ 1.75V	-	300	-	mA	①
		V <sub>IN</sub> =V <sub>OUT(T)</sub> +1.0V, V <sub>CE</sub> =V <sub>IN</sub> 1.8V ≤ V <sub>OUT(T)</sub> ≤ 5.0V	240	300	-		
Short Circuit Current	I <sub>SHORT</sub>	V <sub>IN</sub> =V <sub>OUT(T)</sub> +1.0V, V <sub>CE</sub> =V <sub>IN</sub> V <sub>OUT</sub> ≤ 1.75V, V <sub>IN</sub> =V <sub>OUT(T)</sub> +2.0V	-	50	-	mA	①
CE 'High' Level Voltage	V <sub>CEH</sub>	-	1.6	-	V <sub>IN</sub>	V	①
CE 'Low' Level Voltage	V <sub>CEL</sub>	-	-	-	0.25	V	①
CE 'High' Level Current (Type A)	I <sub>CEH</sub>	V <sub>IN</sub> =V <sub>CE</sub> =V <sub>OUT(T)</sub> +1.0V V <sub>OUT</sub> ≤ 0.95V, V <sub>IN</sub> =V <sub>CE</sub> =2.0V	-0.10	-	5.0	μA	②
CE 'High' Level Current (Type B)			-0.10	-	0.10		
CE 'Low' Level Current	I <sub>CEL</sub>	V <sub>IN</sub> =V <sub>OUT(T)</sub> +1.0V, V <sub>CE</sub> =V <sub>SS</sub> V <sub>OUT</sub> ≤ 0.95V, V <sub>IN</sub> =2.0V	-0.10	-	0.10	μA	②

(\*1) Unless otherwise stated, V<sub>IN</sub>=V<sub>OUT(T)</sub>+1.0V. If V<sub>OUT</sub> is less than 0.95V, V<sub>IN</sub>= 2.0V.

(\*2) V<sub>OUT(T)</sub> = Specified output voltage

(\*3) V<sub>OUT(E)</sub> = Effective output voltage

The output voltage when "V<sub>OUT(T)</sub>+1.0V" is provided at the V<sub>IN</sub> pin while maintaining a certain I<sub>OUT</sub> value.

(\*4) V<sub>dif</sub>={V<sub>IN1</sub>-V<sub>OUT1</sub>}

V<sub>OUT1</sub>=A voltage equal to 98% of the output voltage whenever an amply stabilized I<sub>OUT</sub> {V<sub>OUT(T)</sub>+1.0V} is input.

V<sub>IN1</sub>=The Input Voltage when V<sub>OUT1</sub> appears as Input Voltage is gradually decreased.

(\*5) If V<sub>OUT(T)</sub> is less than 1.45V, V<sub>OUT(T)</sub>-30mV (MIN.), V<sub>OUT(T)</sub>+ 30mV (MAX.)

(\*6) Only for the V<sub>OUT(T)</sub> is more than 3.0V products.

## ELECTRICAL CHARACTERISTICS

●XC6219 Type C,D

Ta=25°C

PARAMETER	SYMBOL	CONDITIONS	MIN.	TYP.	MAX.	UNITS	CIRCUIT
Output Voltage (*5) (2%)	V <sub>OUT(E)</sub> (*3)	I <sub>OUT</sub> =30mA	V <sub>OUT(T)</sub> (*2) ×0.98	V <sub>OUT(T)</sub> (*2)	V <sub>OUT(T)</sub> (*2) ×1.02	V	①
Output Voltage (*6) (1%)			V <sub>OUT(T)</sub> (*2) ×0.99	V <sub>OUT(T)</sub> (*2)	V <sub>OUT(T)</sub> (*2) ×1.01		
Maximum Output Current	I <sub>OUTMAX</sub>	0.9V ≤ V <sub>OUT(T)</sub> ≤ 1.75V	150	-	-	mA	①
		1.8V ≤ V <sub>OUT(T)</sub> ≤ 5.0V	240	-	-		
Load Regulation	ΔV <sub>OUT</sub>	1mA ≤ I <sub>OUT</sub> ≤ 100mA	-	15	50	mV	①
Dropout Voltage (*4)	V <sub>dif1</sub>	I <sub>OUT</sub> =30mA	-	E-1		mV	①
	V <sub>dif2</sub>	I <sub>OUT</sub> =100mA	-	E-2			
Supply Current (Type C)	I <sub>DD</sub>	V <sub>IN</sub> =V <sub>OUT(T)</sub> +1.0V V <sub>OUT</sub> ≤ 0.95V, V <sub>IN</sub> =2.0V V <sub>CE</sub> =V <sub>SS</sub>	-	28	55	μA	②
Supply Current (Type D)		V <sub>IN</sub> =V <sub>OUT(T)</sub> +1.0V, V <sub>CE</sub> =V <sub>IN</sub> V <sub>OUT</sub> ≤ 0.95V, V <sub>IN</sub> =V <sub>CE</sub> =2.0V	-	25	50		
Stand-by Current	I <sub>STB</sub>	V <sub>IN</sub> =V <sub>OUT(T)</sub> +1.0V, V <sub>CE</sub> =V <sub>IN</sub> V <sub>OUT</sub> ≤ 0.95V, V <sub>IN</sub> =V <sub>CE</sub> =2.0V	-	0.01	0.10	μA	②
Line Regulation	ΔV <sub>OUT</sub> / (ΔV <sub>IN</sub> ·V <sub>OUT</sub> )	V <sub>OUT(T)</sub> +1.0V ≤ V <sub>IN</sub> ≤ 6.0V V <sub>OUT</sub> ≤ 0.95V, 2.0V ≤ V <sub>IN</sub> ≤ 6.0V I <sub>OUT</sub> =30mA V <sub>OUT</sub> ≤ 1.75V, I <sub>OUT</sub> =10mA	-	0.01	0.20	%/V	①
Input Voltage	V <sub>IN</sub>	-	2	-	6	V	-
Output Voltage Temperature Characteristics	ΔV <sub>OUT</sub> / (ΔT <sub>opr</sub> ·V <sub>OUT</sub> )	I <sub>OUT</sub> =30mA -40°C ≤ T <sub>opr</sub> ≤ 85°C	-	±100	-	ppm/°C	①
Power Supply Rejection Ratio	PSRR	V <sub>IN</sub> =[V <sub>OUT(T)</sub> +1.0]V+1.0Vp-p <sub>AC</sub> V <sub>OUT</sub> ≤ 1.5, V <sub>IN</sub> =2.5V+1.0Vp-p <sub>AC</sub> I <sub>OUT</sub> =50mA, f=10kHz	-	E-3	-	dB	④
Current Limiter	I <sub>lim</sub>	V <sub>IN</sub> =V <sub>OUT(T)</sub> +2.0V, V <sub>CE</sub> =V <sub>SS</sub> 0.9V ≤ V <sub>OUT(T)</sub> ≤ 1.75V	-	300	-	mA	①
		V <sub>IN</sub> =V <sub>OUT(T)</sub> +1.0V, V <sub>CE</sub> =V <sub>SS</sub> 1.8V ≤ V <sub>OUT(T)</sub> ≤ 5.0V	240	300	-		
Short Circuit Current	I <sub>SHORT</sub>	V <sub>IN</sub> =V <sub>OUT(T)</sub> +1.0V, V <sub>CE</sub> =V <sub>IN</sub> V <sub>OUT</sub> ≤ 1.75V, V <sub>IN</sub> =V <sub>OUT(T)</sub> +2.0V	-	50	-	mA	①
CE 'High' Level Voltage	V <sub>CEH</sub>	-	1.6	-	V <sub>IN</sub>	V	①
CE 'Low' Level Voltage	V <sub>CEL</sub>	-	-	-	0.25	V	①
CE 'High' Level Current	I <sub>CEH</sub>	V <sub>CE</sub> =V <sub>IN</sub> =V <sub>OUT(T)</sub> +1.0V V <sub>OUT</sub> ≤ 0.95V, V <sub>CE</sub> =V <sub>IN</sub> =2.0V	-0.10	-	0.10	μA	②
CE 'Low' Level Current (Type C)	I <sub>CEL</sub>	V <sub>IN</sub> =V <sub>OUT(T)</sub> +1.0V, V <sub>CE</sub> =V <sub>SS</sub> V <sub>OUT</sub> ≤ 0.95V, V <sub>IN</sub> =2.0V	-5.0	-	0.10	μA	②
CE 'Low' Level Current (Type D)		V <sub>IN</sub> =V <sub>OUT(T)</sub> +1.0V, V <sub>CE</sub> =V <sub>IN</sub> V <sub>OUT</sub> ≤ 1.75V, V <sub>IN</sub> =V <sub>OUT(T)</sub> +2.0V	-0.10	-	0.10		

(\*1) Unless otherwise stated, V<sub>IN</sub>=V<sub>OUT(T)</sub>+1.0V. If V<sub>OUT</sub> is less than 0.95V, V<sub>IN</sub>= 2.0V.

(\*2) V<sub>OUT(T)</sub> = Specified output voltage

(\*3) V<sub>OUT(E)</sub> = Effective output voltage

The output voltage when "V<sub>OUT(T)</sub>+1.0V" is provided at the V<sub>IN</sub> pin while maintaining a certain I<sub>OUT</sub> value.

(\*4) V<sub>dif</sub>={V<sub>IN1</sub>-V<sub>OUT1</sub>}

V<sub>OUT1</sub>=A voltage equal to 98% of the output voltage whenever an amply stabilized I<sub>OUT</sub> {V<sub>OUT(T)</sub>+1.0V} is input.

V<sub>IN1</sub>=The Input Voltage when V<sub>OUT1</sub> appears as Input Voltage is gradually decreased.

(\*5) If V<sub>OUT(T)</sub> is less than 1.45V, V<sub>OUT(T)</sub>-30mV (MIN.), V<sub>OUT(T)</sub>+ 30mV (MAX.)

(\*6) Only for the V<sub>OUT(T)</sub> is more than 3.0V products.

## ELECTRICAL CHARACTERISTICS

●XC6219 Type E,F

Ta=25°C

PARAMETER	SYMBOL	CONDITIONS	MIN.	TYP.	MAX.	UNITS	CIRCUIT
Output Voltage <sup>(*5)</sup> (2%)	V <sub>OUT(E)</sub> <sup>(*3)</sup>	I <sub>OUT</sub> =30mA	V <sub>OUT(T)</sub> <sup>(*2)</sup> ×0.98	V <sub>OUT(T)</sub> <sup>(*2)</sup>	V <sub>OUT(T)</sub> <sup>(*2)</sup> ×1.02	V	①
Output Voltage <sup>(*6)</sup> (1%)			V <sub>OUT(T)</sub> <sup>(*2)</sup> ×0.99		V <sub>OUT(T)</sub> <sup>(*2)</sup> ×1.01		
Maximum Output Current	I <sub>OUTMAX</sub>	V <sub>IN</sub> =E-5 <sup>(*7)</sup>	E-4	-	-	mA	①
Load Regulation	ΔV <sub>OUT</sub>	1mA ≤ I <sub>OUT</sub> ≤ 100mA	-	15	50	mV	①
Load Regulation2	ΔV <sub>OUT2</sub>	1mA ≤ I <sub>OUT</sub> ≤ 300mA	-	-	100	mV	①
Dropout Voltage <sup>(*4)</sup>	V <sub>dif1</sub>	I <sub>OUT</sub> =30mA	-	E-1		mV	①
	V <sub>dif2</sub>	I <sub>OUT</sub> =100mA	-	E-2			
Supply Current (Type E)	I <sub>DD</sub>	V <sub>CE</sub> =V <sub>IN</sub> =V <sub>OUT(T)</sub> +1.0V	-	28	55	μA	②
Supply Current (Type F)		V <sub>OUT</sub> ≤ 0.95V, V <sub>CE</sub> =V <sub>IN</sub> =2.0V	-	25	50		
Stand-by Current	I <sub>STB</sub>	V <sub>IN</sub> =V <sub>OUT(T)</sub> +1.0V, V <sub>CE</sub> =V <sub>SS</sub> V <sub>OUT</sub> ≤ 0.95V, V <sub>CE</sub> =V <sub>IN</sub> =2.0V	-	0.01	0.10	μA	②
Line Regulation	ΔV <sub>OUT</sub> / (ΔV <sub>IN</sub> ·V <sub>OUT</sub> )	V <sub>OUT(T)</sub> +1.0V ≤ V <sub>IN</sub> ≤ 6.0V V <sub>OUT</sub> ≤ 0.95V, 2.0V ≤ V <sub>IN</sub> ≤ 6.0V I <sub>OUT</sub> =30mA V <sub>OUT</sub> ≤ 1.75V, I <sub>OUT</sub> =10mA	-	0.01	0.20	%/V	①
Input Voltage	V <sub>IN</sub>	-	2	-	6	V	-
Output Voltage Temperature Characteristics	ΔV <sub>OUT</sub> / (ΔT <sub>OP</sub> ·V <sub>OUT</sub> )	I <sub>OUT</sub> =30mA -40°C ≤ T <sub>OP</sub> ≤ 85°C	-	±100	-	ppm/°C	①
Power Supply Rejection Ratio	PSRR	V <sub>IN</sub> =[V <sub>OUT(T)</sub> +1.0]V+1.0Vp-p <sub>AC</sub> V <sub>OUT</sub> ≤ 1.5, V <sub>IN</sub> =2.5V+1.0Vp-p <sub>AC</sub> I <sub>OUT</sub> =50mA, f=10kHz	-	70	-	dB	④
Current Limiter	I <sub>lim</sub>	V <sub>IN</sub> =V <sub>OUT(T)</sub> +2.0V, V <sub>CE</sub> =V <sub>IN</sub> 0.9V ≤ V <sub>OUT(T)</sub> ≤ 1.75V	-	380	-	mA	①
		V <sub>IN</sub> =V <sub>OUT(T)</sub> +1.0V, V <sub>CE</sub> =V <sub>IN</sub> 1.8V ≤ V <sub>OUT(T)</sub> ≤ 5.0V					
Short Circuit Current	I <sub>SHORT</sub>	V <sub>IN</sub> =V <sub>OUT(T)</sub> +1.0V, V <sub>CE</sub> =V <sub>IN</sub> V <sub>OUT</sub> ≤ 1.75V, V <sub>IN</sub> =V <sub>OUT(T)</sub> +2.0V	-	50	-	mA	①
CE 'High' Level Voltage	V <sub>CEH</sub>	-	1.6	-	V <sub>IN</sub>	V	①
CE 'Low' Level Voltage	V <sub>CEL</sub>	-	-	-	0.25	V	①
CE 'High' Level Current (Type E)	I <sub>CEH</sub>	V <sub>IN</sub> =V <sub>CE</sub> =V <sub>OUT(T)</sub> +1.0V	-0.10	-	5.0	μA	②
CE 'High' Level Current (Type F)		V <sub>OUT</sub> ≤ 0.95V, V <sub>IN</sub> =V <sub>CE</sub> =2.0V	-0.10	-	0.10		
CE 'Low' Level Current	I <sub>CEL</sub>	V <sub>IN</sub> =V <sub>OUT(T)</sub> +1.0V, V <sub>CE</sub> =V <sub>SS</sub> V <sub>OUT</sub> ≤ 0.95V, V <sub>IN</sub> =2.0V	-0.1	-	0.1	μA	②

(\*1) Unless otherwise stated, V<sub>IN</sub>=V<sub>OUT(T)</sub>+1.0V. If V<sub>OUT</sub> is less than 0.95V, V<sub>IN</sub>=2.0V.

(\*2) V<sub>OUT(T)</sub> = Specified output voltage

(\*3) V<sub>OUT(E)</sub> = Effective output voltage

The output voltage when "V<sub>OUT(T)</sub>+1.0V" is provided at the V<sub>IN</sub> pin while maintaining a certain I<sub>OUT</sub> value.

(\*4) V<sub>dif</sub>={V<sub>IN1</sub>-V<sub>OUT1</sub>}

V<sub>OUT1</sub>=A voltage equal to 98% of the output voltage whenever an amply stabilized I<sub>OUT</sub> {V<sub>OUT(T)</sub>+1.0V} is input.

V<sub>IN1</sub>=The Input Voltage when V<sub>OUT1</sub> appears as Input Voltage is gradually decreased.

(\*5) If V<sub>OUT(T)</sub> is less than 1.45V, V<sub>OUT(T)</sub>-30mV (MIN.), V<sub>OUT(T)</sub>+30mV (MAX.)

(\*6) Only for the V<sub>OUT(T)</sub> is more than 3.0V products.

(\*7) Please refer to the "Voltage Chart" table.

## ELECTRICAL CHARACTERISTICS

●XC6219 Type G,H

Ta=25°C

PARAMETER	SYMBOL	CONDITIONS	MIN.	TYP.	MAX.	UNITS	CIRCUIT
Output Voltage <sup>(*)5)</sup> (2%)	V <sub>OUT(E)</sub> <sup>(*)3)</sup>	I <sub>OUT</sub> =30mA	V <sub>OUT(T)</sub> <sup>(*)2)</sup> ×0.98	V <sub>OUT(T)</sub> <sup>(*)2)</sup>	V <sub>OUT(T)</sub> <sup>(*)2)</sup> ×1.02	V	①
Output Voltage <sup>(*)6)</sup> (1%)			V <sub>OUT(T)</sub> <sup>(*)2)</sup> ×0.99	V <sub>OUT(T)</sub> <sup>(*)2)</sup>	V <sub>OUT(T)</sub> <sup>(*)2)</sup> ×1.01		
Maximum Output Current	I <sub>OUTMAX</sub>	V <sub>IN</sub> =E-5 <sup>(*)7)</sup>	E-4	-	-	mA	①
Load Regulation	ΔV <sub>OUT</sub>	1mA ≤ I <sub>OUT</sub> ≤ 100mA	-	15	50	mV	①
Load Regulation2	ΔV <sub>OUT2</sub>	1mA ≤ I <sub>OUT</sub> ≤ 300mA	-	-	100	mV	①
Dropout Voltage <sup>(*)4)</sup>	V <sub>dif1</sub>	I <sub>OUT</sub> =30mA	-	E-1		mV	①
	V <sub>dif2</sub>	I <sub>OUT</sub> =100mA	-	E-2			
Supply Current (Type G)	I <sub>DD</sub>	V <sub>CE</sub> =V <sub>IN</sub> =V <sub>OUT(T)</sub> +1.0V V <sub>OUT</sub> ≤ 0.95V, V <sub>IN</sub> =2.0V	-	28	55	μA	②
Supply Current (Type H)		V <sub>CE</sub> =V <sub>SS</sub>	-	25	50		
Stand-by Current	I <sub>STB</sub>	V <sub>IN</sub> =V <sub>OUT(T)</sub> +1.0V, V <sub>CE</sub> =V <sub>IN</sub> V <sub>OUT</sub> ≤ 0.95V, V <sub>CE</sub> =V <sub>IN</sub> =2.0V	-	0.01	0.10	μA	②
Line Regulation	ΔV <sub>OUT</sub> / (ΔV <sub>IN</sub> ·V <sub>OUT</sub> )	V <sub>OUT(T)</sub> +1.0V ≤ V <sub>IN</sub> ≤ 6.0V V <sub>OUT</sub> ≤ 0.95V, 2.0V ≤ V <sub>IN</sub> ≤ 6.0V I <sub>OUT</sub> =30mA V <sub>OUT</sub> ≤ 1.75V, I <sub>OUT</sub> =10mA	-	0.01	0.20	%/V	①
Input Voltage	V <sub>IN</sub>	-	2	-	6	V	-
Output Voltage Temperature Characteristics	ΔV <sub>OUT</sub> / (ΔTopr·V <sub>OUT</sub> )	I <sub>OUT</sub> =30mA -40°C ≤ Topr ≤ 85°C	-	±100	-	ppm/°C	①
Power Supply Rejection Ratio	PSRR	V <sub>IN</sub> =[V <sub>OUT(T)</sub> +1.0]V+1.0Vp-p <sub>AC</sub> V <sub>OUT</sub> ≤ 1.5, V <sub>IN</sub> =2.5V+1.0Vp-p <sub>AC</sub> I <sub>OUT</sub> =50mA, f=10kHz	-	70	-	dB	④
Current Limiter	I <sub>lim</sub>	V <sub>IN</sub> =V <sub>OUT(T)</sub> +2.0V, V <sub>CE</sub> =V <sub>SS</sub> 0.9V ≤ V <sub>OUT(T)</sub> ≤ 1.75V	-	380	-	mA	①
		V <sub>IN</sub> =V <sub>OUT(T)</sub> +1.0V, V <sub>CE</sub> =V <sub>SS</sub> 1.8V ≤ V <sub>OUT(T)</sub> ≤ 5.0V					
Short Circuit Current	I <sub>SHORT</sub>	V <sub>IN</sub> =V <sub>OUT(T)</sub> +1.0V, V <sub>CE</sub> =V <sub>SS</sub> V <sub>OUT</sub> ≤ 1.75V, V <sub>IN</sub> =V <sub>OUT(T)</sub> +2.0V	-	50	-	mA	①
CE 'High' Level Voltage	V <sub>CEH</sub>	-	1.6	-	V <sub>IN</sub>	V	①
CE 'Low' Level Voltage	V <sub>CEL</sub>	-	-	-	0.25	V	①
CE 'High' Level Current	I <sub>CEH</sub>	V <sub>CE</sub> =V <sub>IN</sub> =V <sub>OUT(T)</sub> +1.0V V <sub>OUT</sub> ≤ 0.95V, V <sub>CE</sub> =V <sub>IN</sub> =2.0V	-0.10	-	0.10	μA	②
CE 'Low' Level Current (Type G)	I <sub>CEL</sub>	V <sub>IN</sub> =V <sub>OUT(T)</sub> +1.0V, V <sub>CE</sub> =V <sub>SS</sub>	-5.0	-	0.10	μA	②
CE 'Low' Level Current (Type H)		V <sub>OUT</sub> ≤ 0.95V, V <sub>IN</sub> =2.0V	-0.10	-	0.10		

(\*1) Unless otherwise stated, V<sub>IN</sub>=V<sub>OUT(T)</sub>+1.0V. If V<sub>OUT</sub> is less than 0.95V, V<sub>IN</sub>= 2.0V.

(\*2) V<sub>OUT(T)</sub> = Specified output voltage

(\*3) V<sub>OUT(E)</sub> = Effective output voltage

The output voltage when "V<sub>OUT(T)</sub>+1.0V" is provided at the V<sub>IN</sub> pin while maintaining a certain I<sub>OUT</sub> value.

(\*4) V<sub>dif</sub>={V<sub>IN1</sub>-V<sub>OUT1</sub> }

V<sub>OUT1</sub>=A voltage equal to 98% of the output voltage whenever an amply stabilized I<sub>OUT</sub> {V<sub>OUT(T)</sub>+1.0V} is input.

V<sub>IN1</sub>=The Input Voltage when V<sub>OUT1</sub> appears as Input Voltage is gradually decreased.

(\*5) If V<sub>OUT(T)</sub> is less than 1.45V, V<sub>OUT(T)</sub>-30mV (MIN.), V<sub>OUT(T)</sub>+ 30mV (MAX.)

(\*6) Only for the V<sub>OUT(T)</sub> is more than 3.0V products.

(\*7) Please refer to the "Voltage Chart" table.

## ■ ELECTRICAL CHARACTERISTICS (Continued)

### ● Voltage Chart

SYMBOL PARAMETER	E-0				E-1		E-2		E-3
	OUTPUT VOLTAGE (2%) (V)		OUTPUT VOLTAGE (1%) (V)		DROPOUT VOLTAGE1 (mV) (I <sub>OUT</sub> =30mA)		DROPOUT VOLTAGE2 (mV) (I <sub>OUT</sub> =100mA)		Power Supply Rejection Ratio
OUTPUT VOLTAGE					Ta=25°C		Ta=25°C		Ta=25°C
V <sub>OUT(T)</sub>	V <sub>OUT</sub>		V <sub>OUT</sub>		Vdif1		Vdif2		PSRR
	MIN	MAX	MIN	MAX	TYP	MAX	TYP	MAX	TYP
0.90	0.870	0.930	-	-	1100	1110	1150	1200	65
0.95	0.920	0.980	-	-					
1.00	0.970	1.030	-	-	1000	1010	1050	1100	
1.05	1.020	1.080	-	-					
1.10	1.070	1.130	-	-	900	910	950	1000	
1.15	1.120	1.180	-	-					
1.20	1.170	1.230	-	-	800	810	850	900	
1.25	1.220	1.280	-	-					
1.30	1.270	1.330	-	-	700	710	750	800	
1.35	1.320	1.380	-	-					
1.40	1.370	1.430	-	-	600	610	650	700	
1.45	1.420	1.480	-	-					
1.50	1.470	1.530	-	-	500	510	550	600	
1.55	1.519	1.581	-	-					
1.60	1.568	1.632	-	-	400	410	500	550	
1.65	1.617	1.683	-	-					
1.70	1.666	1.734	-	-	300	310	400	450	
1.75	1.715	1.785	-	-					
1.80	1.764	1.836	-	-	200	210	300	400	
1.85	1.813	1.887	-	-					
1.90	1.862	1.938	-	-	120	150	280	380	
1.95	1.911	1.989	-	-					
2.00	1.960	2.040	-	-	80	120	240	350	
2.05	2.009	2.091	-	-				330	
2.10	2.058	2.142	-	-					
2.15	2.107	2.193	-	-					
2.20	2.156	2.244	-	-					
2.25	2.205	2.295	-	-					
2.30	2.254	2.346	-	-					
2.35	2.303	2.397	-	-				310	
2.40	2.352	2.448	-	-					
2.45	2.401	2.499	-	-					
2.50	2.450	2.550	-	-	70	100	220	290	
2.55	2.499	2.601	-	-					
2.60	2.548	2.652	-	-					
2.65	2.597	2.703	-	-					
2.70	2.646	2.754	-	-					
2.75	2.695	2.805	-	-					
2.80	2.744	2.856	-	-				270	
2.85	2.793	2.907	-	-					
2.90	2.842	2.958	-	-					
2.95	2.891	3.009	-	-					

## ■ ELECTRICAL CHARACTERISTICS (Continued)

### ● Voltage Chart

SYMBOL	E-0				E-1		E-2		E-3
PARAMETER	OUTPUT VOLTAGE (2%) (V)		OUTPUT VOLTAGE (1%) (V)		DROPOUT VOLTAGE1 (mV) (I <sub>OUT</sub> =30mA)		DROPOUT VOLTAGE2 (mV) (I <sub>OUT</sub> =100mA)		Power Supply Rejection Ratio
OUTPUT VOLTAGE					Ta=25°C		Ta=25°C		Ta=25°C
V <sub>OUT(T)</sub>	V <sub>OUT</sub>		V <sub>OUT</sub>		Vdif1		Vdif2		PSRR
	MIN	MAX	MIN	MAX	TYP	MAX	TYP	MAX	TYP
3.00	2.940	3.060	2.970	3.030	60	90	200	270	70
3.05	2.989	3.111	3.020	3.081				250	
3.10	3.038	3.162	3.069	3.131					
3.15	3.087	3.213	3.119	3.182					
3.20	3.136	3.264	3.168	3.232					
3.25	3.185	3.315	3.218	3.283					
3.30	3.234	3.366	3.267	3.333					
3.35	3.283	3.417	3.317	3.384					
3.40	3.332	3.468	3.366	3.434					
3.45	3.381	3.519	3.416	3.485					
3.50	3.430	3.570	3.465	3.535					
3.55	3.479	3.621	3.515	3.586					
3.60	3.528	3.672	3.564	3.636					
3.65	3.577	3.723	3.614	3.687					
3.70	3.626	3.774	3.663	3.737					
3.75	3.675	3.825	3.713	3.788					
3.80	3.724	3.876	3.762	3.838					
3.85	3.773	3.927	3.812	3.889					
3.90	3.822	3.978	3.861	3.939					
3.95	3.871	4.029	3.911	3.990					
4.00	3.920	4.080	3.960	4.040	80	180	230		
4.05	3.969	4.131	4.010	4.091					
4.10	4.018	4.182	4.059	4.141					
4.15	4.067	4.233	4.109	4.192					
4.20	4.116	4.284	4.158	4.242					
4.25	4.165	4.335	4.208	4.293					
4.30	4.214	4.386	4.257	4.343					
4.35	4.263	4.437	4.307	4.394					
4.40	4.312	4.488	4.356	4.444					
4.45	4.361	4.539	4.405	4.494					
4.50	4.410	4.590	4.455	4.545					
4.55	4.459	4.641	4.504	4.595					
4.60	4.508	4.692	4.554	4.646					
4.65	4.557	4.743	4.603	4.696					
4.70	4.606	4.794	4.653	4.747					
4.75	4.655	4.845	4.702	4.797					
4.80	4.704	4.896	4.752	4.848					
4.85	4.753	4.947	4.801	4.898					
4.90	4.802	4.998	4.851	4.949					
4.95	4.851	5.049	4.900	4.999					
5.00	4.900	5.100	4.950	5.050	50	70	160	210	

## ■ ELECTRICAL CHARACTERISTICS (Continued)

● Specification & Condition by Series

SYMBOL	E-5	E-4
CONDITION, RATINGS	INPUT VOLTAGE (V)	MAX. OUTPUT CURRENT (mA)
OUTPUT VOLTAGE (V)	$V_{IN}$	MIN
0.90~0.95	2.5	260
1.00~1.05	2.5	260
1.10~1.15	2.6	270
1.20~1.25	2.7	290
1.30~1.35	2.8	300
1.40~1.45	2.9	
1.50~1.95	3.0	
2.00~6.00	$V_{OUT(T)}+1.0$	

\*  $V_{OUT(T)}$ =Nominal output voltage

## TEST CIRCUITS

Circuit ①



Circuit ②



Circuit ③



Circuit ④



\*TEST CIRCUIT  $V_{CE}$  (CE Pin Voltage)

ACTIVE

XC6219 Type A,B,E,F:  $V_{CE} = V_{IN}$

XC6219 Type C,D,G,H:  $V_{CE} = V_{SS}$

STANDBY

XC6219 Type A,B,E,F:  $V_{CE} = V_{SS}$

XC6219 Type C,D,G,H:  $V_{CE} = V_{IN}$

## OPERATIONAL EXPLANATION

### <Output Voltage Control>

The voltage divided by resistors R1 & R2 is compared with the internal reference voltage by the error amplifier. The P-channel MOSFET, which is connected to the V<sub>OUT</sub> pin, is then driven by the subsequent output signal. The output voltage at the V<sub>OUT</sub> pin is controlled and stabilized by a system of negative feedback. The current limit circuit and short protect circuit operate in relation to the level of output current. Further, the IC's internal circuitry can be shutdown via the CE pin's signal



### <Low ESR Capacitors>

With the XC6219 series, a stable output voltage is achievable even if used with low ESR capacitors as a phase compensation circuit is built-in. In order to ensure the effectiveness of the phase compensation, we suggest that an output capacitor (C<sub>L</sub>) is connected as close as possible to the output pin (V<sub>OUT</sub>) and the V<sub>SS</sub> pin. Please use an output capacitor with a capacitance value of at least 1.0 μF. Also, please connect an input capacitor (C<sub>IN</sub>) of 1.0 μF between the V<sub>IN</sub> pin and the V<sub>SS</sub> pin in order to ensure a stable power input.

Stable phase compensation may not be ensured if the capacitor runs out capacitance when depending on bias and temperature. In case the capacitor depends on the bias and temperature, please make sure the capacitor can ensure the actual capacitance.

### <Current Limiter, Short-Circuit Protection>

The XC6219 series includes a combination of a fixed current limiter circuit & a foldback circuit, which aid the operations of the current limiter and circuit protection. When the load current reaches the current limit level, the fixed current limiter circuit operates and output voltage drops. As a result of this drop in output voltage, the foldback circuit operates, output voltage drops further and output current decreases. When the output pin is shorted, a current of about 50mA flows.

### <CE Pin>

The IC's internal circuitry can be shutdown via the signal from the CE pin with the XC6219 series. In shutdown mode, output at the V<sub>OUT</sub> pin will be pulled down to the V<sub>SS</sub> level via R1 & R2. The operational logic of the IC's CE pin is selectable (please refer to the selection guide). Note that as the standard XC6219B type's regulator 1 and 2 are both 'High Active/No Pull-Down', operations will become unstable with the CE pin open. Although the CE pin is equal to an inverter input with CMOS hysteresis, with either the pull-up or pull-down options, the CE pin input current will increase when the IC is in operation. We suggest that you use this IC with either a V<sub>IN</sub> voltage or a V<sub>SS</sub> voltage input at the CE pin. If this IC is used with the correct specifications for the CE pin, the operational logic is fixed and the IC will operate normally. However, supply current may increase as a result of through current in the IC's internal circuitry.

## NOTES ON USE

1. For temporary, transitional voltage drop or voltage rising phenomenon, the IC is liable to malfunction should the ratings be exceeded.
2. Where wiring impedance is high, operations may become unstable due to noise and/or phase lag depending on output current. Please keep the resistance low between V<sub>IN</sub> and V<sub>SS</sub> wiring in particular.
3. Please wire the input capacitor (C<sub>IN</sub>) and the output capacitor (C<sub>L</sub>) as close to the IC as possible.
4. The IC is controlled with constant current start-up. Start-up sequence control is requested to draw a load current after even nominal output voltage rising up the output voltage.
5. Torex places an importance on improving our products and their reliability.

We request that users incorporate fail-safe designs and post-aging protection treatment when using Torex products in their systems.

## TYPICAL PERFORMANCE CHARACTERISTICS

### (1) Output Voltage vs. Output Current



## ■ TYPICAL PERFORMANCE CHARACTERISTICS (Continued)

### (2) Output Voltage vs. Input Voltage

**XC6219x182**



**XC6219x182**



**XC6219x252**



**XC6219x252**



**XC6219x302**



**XC6219x302**



## TYPICAL PERFORMANCE CHARACTERISTICS (Continued)

### (3) Dropout Voltage vs. Output Current



### (4) Supply Current vs. Input Voltage



## ■ TYPICAL PERFORMANCE CHARACTERISTICS (Continued)

### (4) Supply Current vs. Input Voltage (Continued)

**XC6219x302**



### (5) Output Voltage vs. Ambient Temperature

**XC6219x182**



**XC6219x252**

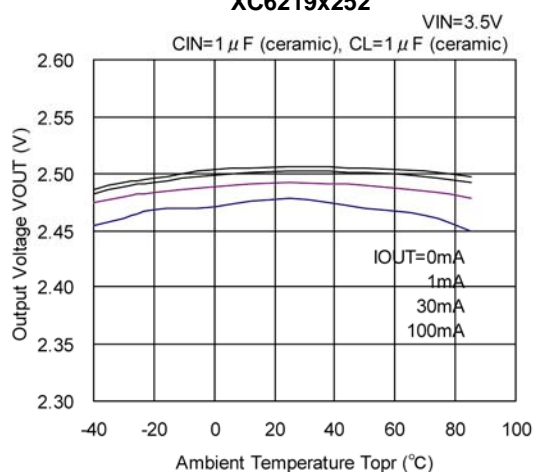

**XC6219x302**



## TYPICAL PERFORMANCE CHARACTERISTICS (Continued)

(6) Supply Current vs. Ambient Temperature



■ TYPICAL PERFORMANCE CHARACTERISTICS (Continued)

(7) Input Transient Response

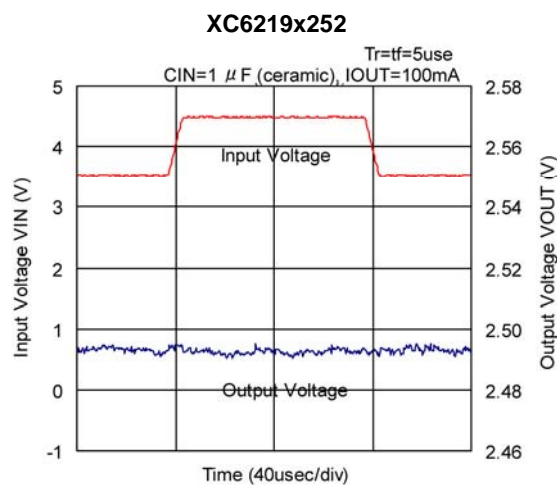
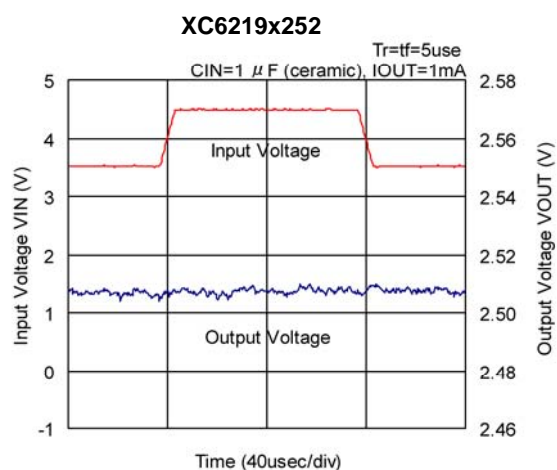
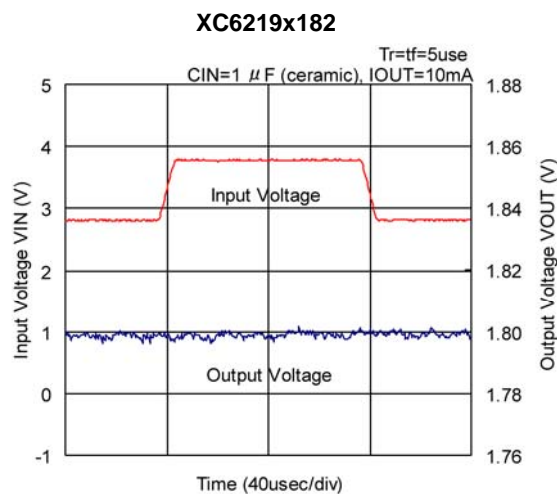

## TYPICAL PERFORMANCE CHARACTERISTICS (Continued)

### (7) Input Transient Response (Continued)

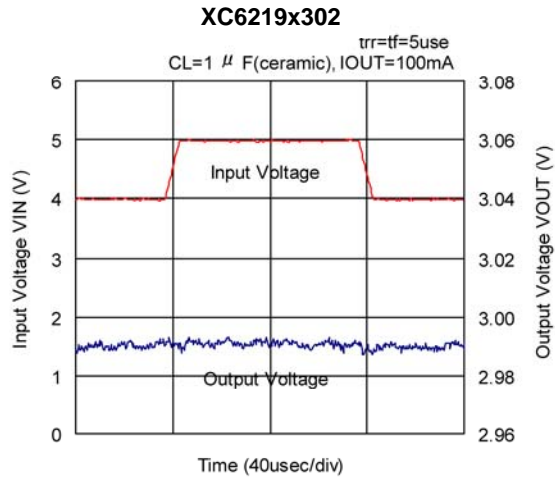
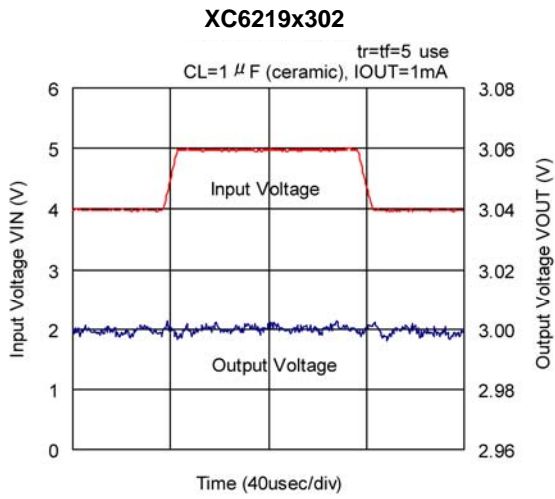

### (8) Load Transient Response

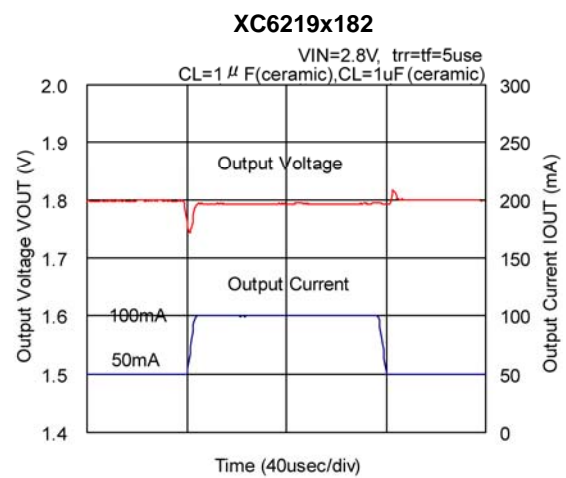
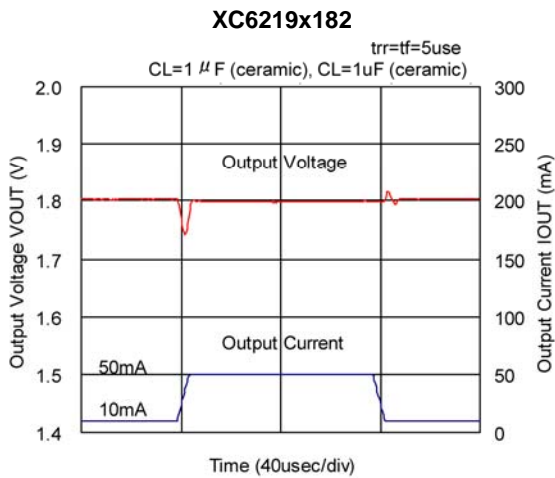

## ■ TYPICAL PERFORMANCE CHARACTERISTICS (Continued)

### (8) Load Transient Response (Continued)



## TYPICAL PERFORMANCE CHARACTERISTICS (Continued)

### (8) Load Transient Response (Continued)



### (9) Ripple Rejection Rate



**PACKAGING INFORMATION**

● SOT-25



● SOT-89-5



● USP-6B



● USP-6B Reference Pattern Layout



● USP-6B Reference Metal Mask Design



## ● SOT-25 Power Dissipation

Power dissipation data for the SOT-25 is shown in this page.  
The value of power dissipation varies with the mount board conditions.  
Please use this data as the reference data taken in the following condition.

### 1. Measurement Condition

Condition:	Mount on a board
Ambient:	Natural convection
Soldering:	Lead (Pb) free
Board Dimensions:	40 x 40 mm (1600 mm <sup>2</sup> in one side)
Metal Area :	Copper (Cu) traces occupy 50% of the board area in top and back faces. Package heat-sink is tied to the copper traces
Material:	Glass Epoxy (FR-4)
Thickness:	1.6 mm
Through-hole:	4 x 0.8 Diameter

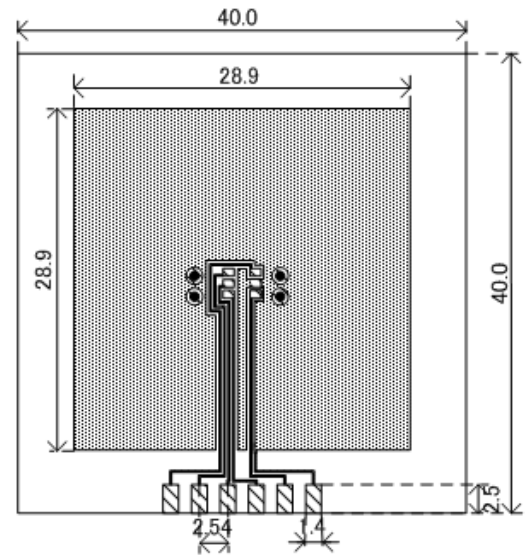

Evaluation Board (Unit: mm)

### 2. Power Dissipation vs. Ambient Temperature ( 85°C )

Board Mount ( Tjmax=125°C )

Ambient Temperature (°C)	Power Dissipation Pd (mW)	Thermal Resistance (°C/W)
25	600	166.67
85	240	



● **SOT-89-5 Power Dissipation**

Power dissipation data for the SOT-89-5 is shown in this page.  
The value of power dissipation varies with the mount board conditions.  
Please use this data as the reference data taken in the following condition.

1. Measurement Condition

Condition: Mount on a board  
 Ambient: Natural convection  
 Soldering: Lead (Pb) free  
 Board Dimensions: 40 x 40 mm (1600 mm<sup>2</sup> in one side)  
 Metal Area : Copper (Cu) traces occupy 50% of the board area in top and back faces.  
 Package heat-sink is tied to the copper traces  
 Material: Glass Epoxy (FR-4)  
 Thickness: 1.6 mm  
 Through-hole: 5 x 0.8 Diameter



Evaluation Board (Unit: mm)

2. Power Dissipation vs. Ambient Temperature ( 85°C )

Board Mount ( Tjmax=125°C)

Ambient Temperature (°C)	Power Dissipation Pd (mW)	Thermal Resistance (°C/W)
25	1300	76.92
85	520	



## ● USP-6B Power Dissipation

Power dissipation data for the USP-6B is shown in this page.  
 The value of power dissipation varies with the mount board conditions.  
 Please use this data as the reference data taken in the following condition.

### 1. Measurement Condition

Condition: Mount on a board  
 Ambient: Natural convection  
 Soldering: Lead (Pb) free  
 Board Dimensions: 40 x 40 mm (1600 mm<sup>2</sup> in one side)  
 Metal Area: Copper (Cu) traces occupy 50% of the board area in top and back faces.  
 Package heat-sink is tied to the copper traces  
 Material: Glass Epoxy (FR-4)  
 Thickness: 1.6 mm  
 Through-hole: 4 x 0.8 Diameter



Evaluation Board (Unit: mm)

### 2. Power Dissipation vs. Ambient Temperature

Board Mount ( $T_j \text{ max} = 125^\circ\text{C}$ )

Ambient Temperature (°C)	Power Dissipation Pd (mW)	Thermal Resistance(°C/W)
25	1000	100.00
85	400	



## MARKING RULE

### ● SOT-25, SOT-89-5



① represents product series

MARK	PRODUCT SERIES
L	XC6219xxxxxx

② represents type of regulator

MARK				PRODUCT SERIES
V <sub>OUT</sub> 100mV INCREMENTS		V <sub>OUT</sub> 50mV INCREMENTS		
V <sub>OUT</sub> :0.1~3.0V	V <sub>OUT</sub> :3.1~6.0V	V <sub>OUT</sub> :0.15~3.05V	V <sub>OUT</sub> :3.15~6.05V	
V	A	E	L	XC6219Axxxxx
X	B	F	M	XC6219Bxxxxx
Y	C	H	N	XC6219Cxxxxx
Z	D	K	P	XC6219Dxxxxx
<u>V</u>	<u>A</u>	<u>E</u>	<u>L</u>	XC6219Exxxxx
<u>X</u>	<u>B</u>	<u>F</u>	<u>M</u>	XC6219Fxxxxx
<u>Y</u>	<u>C</u>	<u>H</u>	<u>N</u>	XC6219Gxxxxx
<u>Z</u>	<u>D</u>	<u>K</u>	<u>P</u>	XC6219Hxxxxx

③ represents output voltage

MARK	OUTPUT VOLTAGE (V)				MARK	OUTPUT VOLTAGE (V)			
0	-	3.1	-	3.15	F	1.6	4.6	1.65	4.65
1	-	3.2	-	3.25	H	1.7	4.7	1.75	4.75
2	-	3.3	-	3.35	K	1.8	4.8	1.85	4.85
3	-	3.4	-	3.45	L	1.9	4.9	1.95	4.95
4	-	3.5	-	3.55	M	2.0	5.0	2.05	-
5	-	3.6	-	3.65	N	2.1	-	2.15	-
6	-	3.7	-	3.75	P	2.2	-	2.25	-
7	-	3.8	-	3.85	R	2.3	-	2.35	-
8	0.9	3.9	0.95	3.95	S	2.4	-	2.45	-
9	1.0	4.0	1.05	4.05	T	2.5	-	2.55	-
A	1.1	4.1	1.15	4.15	U	2.6	-	2.65	-
B	1.2	4.2	1.25	4.25	V	2.7	-	2.75	-
C	1.3	4.3	1.35	4.35	X	2.8	-	2.85	-
D	1.4	4.4	1.45	4.45	Y	2.9	-	2.95	-
E	1.5	4.5	1.55	4.55	Z	3.0	-	3.05	-

④ represents production lot number

0 to 9, A to Z reverse character of 0 to 9, A to Z repeated (G, I, J, O, Q, W excluded)

## MARKING RULE (Continued)

### ● USP-6B



USP-6B  
(TOP VIEW)

①② represents product series

MARK		PRODUCT SERIES
①	②	
1	9	XC6219xxxxDx

③ represents type of regulator

MARK	TYPE	PRODUCT SERIES
A	High Active, pull-down resistor built-in (semi-custom)	XC6219AxxxMx
B	High Active, no pull-down resistor built-in (standard)	XC6219BxxxMx
C	Low Active, pull-up resistor built-in (semi-custom)	XC6219CxxxMx
D	Low Active, no pull-up resistor built-in (semi-custom)	XC6219DxxxMx
E	High Active, pull-down resistor built-in (semi-custom)	XC6219ExxxDx
F	High Active, no pull-down resistor built-in (standard)	XC6219FxxxDx
Z	Low Active, pull-up resistor built-in (semi-custom)	XC6219GxxxDx
H	Low Active, no pull-up resistor built-in (semi-custom)	XC6219HxxxDx

④ represents product series

MARK	VOLTAGE (V)	PRODUCT SERIES
3	3.X	XC6219x3xxDx
5	5.X	XC6219x5xxDx

⑤ represents output voltage

MARK	VOLTAGE	PRODUCT SERIES	SYMBOL	VOLTAGE	PRODUCT SERIES
0	X.0	XC6219xx0xDx	A	X.05	XC6219xx0ADx
1	X.1	XC6219xx1xDx	B	X.15	XC6219xx1ADx
2	X.2	XC6219xx2xDx	C	X.25	XC6219xx2ADx
3	X.3	XC6219xx3xDx	D	X.35	XC6219xx3ADx
4	X.4	XC6219xx4xDx	E	X.45	XC6219xx4ADx
5	X.5	XC6219xx5xDx	F	X.55	XC6219xx5ADx
6	X.6	XC6219xx6xDx	H	X.65	XC6219xx6ADx
7	X.7	XC6219xx7xDx	K	X.75	XC6219xx7ADx
8	X.8	XC6219xx8xDx	L	X.85	XC6219xx8ADx
9	X.9	XC6219xx9xDx	M	X.95	XC6219xx9ADx

⑥ represents production lot number

0 to 9, A to Z repeated (G, I, J, O, Q, W excluded)



\* No character inversion used.

1. The products and product specifications contained herein are subject to change without notice to improve performance characteristics. Consult us, or our representatives before use, to confirm that the information in this datasheet is up to date.
2. We assume no responsibility for any infringement of patents, patent rights, or other rights arising from the use of any information and circuitry in this datasheet.
3. Please ensure suitable shipping controls (including fail-safe designs and aging protection) are in force for equipment employing products listed in this datasheet.
4. The products in this datasheet are not developed, designed, or approved for use with such equipment whose failure or malfunction can be reasonably expected to directly endanger the life of, or cause significant injury to, the user.  
(e.g. Atomic energy; aerospace; transport; combustion and associated safety equipment thereof.)
5. Please use the products listed in this datasheet within the specified ranges.  
Should you wish to use the products under conditions exceeding the specifications, please consult us or our representatives.
6. We assume no responsibility for damage or loss due to abnormal use.
7. All rights reserved. No part of this datasheet may be copied or reproduced without the prior permission of TOREX SEMICONDUCTOR LTD.

**TOREX SEMICONDUCTOR LTD.**

## Looking for pricing, stock, or lifecycle information?

Click below to explore more details on WIN SOURCE:

-  [View XC6219D252MR on WIN SOURCE](#)
-  [Torex Semiconductor Ltd Information](#)

## Optimize Your Supply Chain with WIN SOURCE Solutions

-  Global Sourcing Solution
-  Obsolete Management
-  Cost Control Management
-  Shortage Management
-  Alternative Solution
-  Excess Inventory Management