



**THE DATASHEET OF
XC6220B331PR-G**



1A LDO Voltage Regulator with “GreenOperation”

☆GreenOperation-Compatible

■ GENERAL DESCRIPTION

The XC6220 series is a highly accurate, low noise, high speed, low dropout, and large current CMOS voltage regulator with GreenOperation function. The series consists of a voltage reference, an error amplifier, a current limiter, an inrush current prevention circuit and a phase compensation circuit plus a driver transistor.

With a 0.2Ω on-resistance driver transistor integrated and with output currents up to 1A, the ultra low dropout voltage performance greatly extends battery life as does the GreenOperation function which can switch between high speed and power save modes automatically. Low ESR ceramic capacitors can be used for the output stabilization capacitor (C_L).

Output voltage is selectable in 0.05V increments within the range of 0.8V~5.0V, using laser trimming technologies.

An over current protection circuit and a thermal shutdown circuit are built in. The over current protection circuit will operate when the output current reaches its limit current. The thermal shutdown circuit will operate when the junction temperature reaches its limit temperature. The inrush protection circuit works by controlling the inrush current which is charged to C_L when the IC starts up. In this way, any fluctuations to V_{IN} caused by inrush current during system start up can be minimized.

The CE function enables the output to be turned off and the IC becomes a stand-by mode resulting in greatly reduced power consumption.

■ APPLICATIONS

- CD-ROM, CD-R/RW drives
- DVD drives
- HDD drives
- MIDs, UMPCs
- Digital still cameras, Video cameras
- Portable AV equipment

■ FEATURES

Maximum Output Current	: 1000mA (TYP.:1200mA limit) ($1.2V \leq V_{OUT} \leq 5.0V$)
Dropout Voltage	: 20mV @ 100mA ($V_{OUT}=3.0V$) : 60mV @ 300mA ($V_{OUT}=3.0V$)
Operating Voltage Range	: 1.6V ~ 6.0V
Output Voltage Range	: 0.8V ~ 5.0V (0.05V increments)
Accuracy	: $\pm 1\%$ ($V_{OUT} \geq 2.0V$) : $\pm 20mV$ ($V_{OUT} < 2.0V$)
Low Power Consumption	: 8 μA (TYP.) in PS mode : 50 μA (TYP.) in HS mode
Operating Temperature	: - 40°C ~ +85°C
Thermal Shutdown	: Detect 150°C, Release 135°C(TYP.)
Inrush Current Protection	: 700mA (MAX.)
C_L Auto Discharge	: XC6220B/D Series
CE Pull-Down Resistor	: XC6220C/D Series
Output Capacitor	: Ceramic Capacitor Compatible
Packages	: USP-6C, SOT-25, SOT-89-5
Environmentally Friendly	: EU RoHS Compliant, Pb Free

■ TYPICAL APPLICATION CIRCUIT

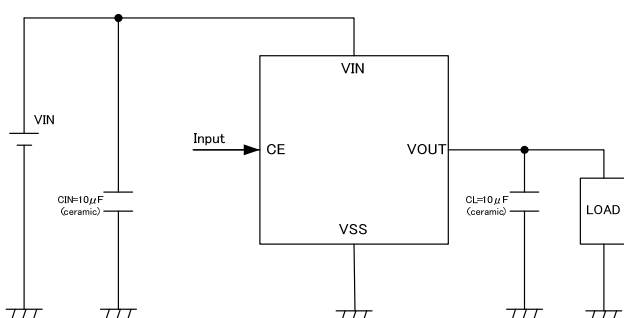

■ TYPICAL PERFORMANCE CHARACTERISTICS

XC6220x181

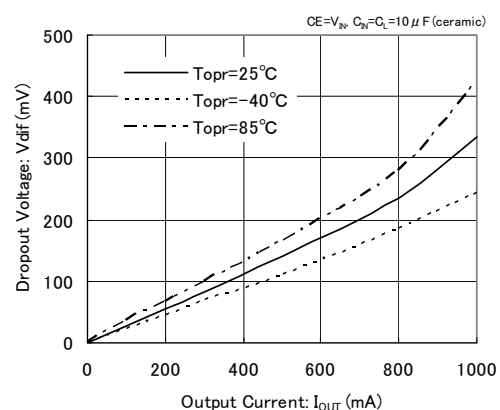

PIN CONFIGURATION

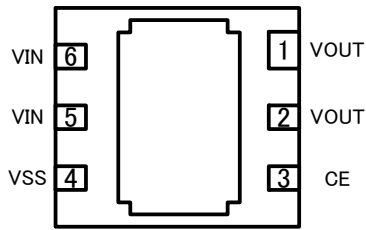

USP-6C
(BOTTOM VIEW)

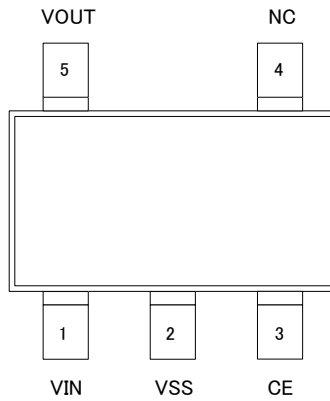

SOT-25
(TOP VIEW)

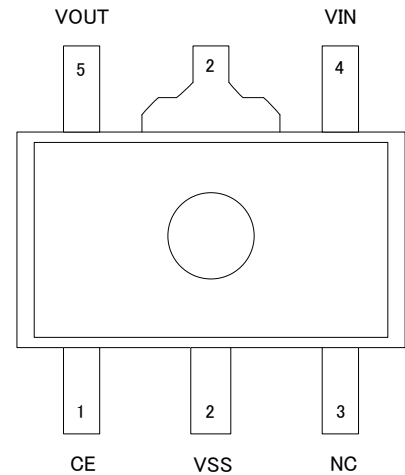

SOT-89-5
(TOP VIEW)

* The No.5 and 6 V_{IN} pins should be connected. The No.1 and 2 pins V_{OUT} pins should be connected. The dissipation pad for the USP-6C package should be solder-plated in recommended mount pattern and metal masking so as to enhance mounting strength and heat release. If the pad needs to be connected to other pins, it should be connected to the V_{SS} (No. 4)

PIN ASSIGNMENT

PIN NUMBER			PIN NAME	FUNCTIONS
SOT-25	SOT-89-5	USP-6C		
3	1	3	CE	ON/OFF Control
1	4	6 & 5	V_{IN}	Power Input
2	2	4	V_{SS}	Ground
5	5	1 & 2	V_{OUT}	Output
4	3	-	NC	No connection

■ PRODUCT CLASSIFICATION

● Selection Guide

Please see the optional setting for C_L discharge and internal CE pull-down.

PRODUCT NAME	CONDITIONS
XC6220A	without CE Pull-down resistor, without C_L auto discharge (Semi-custom)
XC6220B	without CE Pull-down resistor, with C_L auto discharge (Standard)
XC6220C	with CE Pull-down resistor, without C_L auto discharge (Semi-custom)
XC6220D	with CE Pull-down resistor, with C_L auto discharge (Semi-custom)

● Ordering Information

XC6220 ①②③④⑤⑥-⑦^(*)

DESIGNATOR	DESCRIPTION	SYMBOL	DESCRIPTION
①	Type of CE	A	without CE Pull-down resistor, without C_L discharge (Semi-custom)
		B	without CE Pull-down resistor, with C_L discharge (Standard)
		C	with CE Pull-down resistor, without C_L discharge (Semi-custom)
		D	with CE Pull-down resistor, with C_L discharge (Semi-custom)
② ③	Output Voltage	08~50	e.g. 3.0V → ①=3, ②=0
④	Output Voltage Accuracy	1	Output voltage {O.O0v} (the 2 nd decimal place is "0") :HS Mode Accuracy $\pm 1\%$ ($V_{OUT(T)} \geq 2.1V$), within 0.02V ($V_{OUT(T)} \leq 2.0V$) :PS Mode Accuracy $\pm 2\%$ ($V_{OUT(T)} \geq 2.1V$), within 0.04V ($V_{OUT(T)} \leq 2.0V$)
		B	Output voltage {O.O5v} (the 2 nd decimal place is "5") :HS Mode Accuracy $\pm 1\%$ ($V_{OUT(T)} \geq 2.05V$), within 0.02V ($V_{OUT(T)} \leq 1.95V$) :PS Mode Accuracy $\pm 2\%$ ($V_{OUT(T)} \geq 2.05V$), within 0.04V ($V_{OUT(T)} \leq 1.95V$)
⑤⑥-⑦	Packages Taping Type ^(*)	MR	SOT-25
		MR-G	SOT-25
		PR	SOT-89-5
		PR-G	SOT-89-5
		ER	USP-6C
		ER-G	USP-6C

^(*) The "-G" suffix indicates that the products are Halogen and Antimony free as well as being fully RoHS compliant.

^(*) The device orientation is fixed in its embossed tape pocket. For reverse orientation, please contact your local Torex sales office or representative. (Standard orientation: ⑤R-⑦, Reverse orientation: ⑤L-⑦)

■ ELECTRICAL CHARACTERISTICS

●XC6220A/B/C/D Series

Ta=25°C

PARAMETER	SYMBOL	CONDITIONS	MIN.	TYP.	MAX.	UNITS	CIRCUIT
Output Voltage	$V_{OUT(E)}$ (2)	High Speed Mode (HS) $2.0V \leq V_{OUT(T)} \leq 5.0V$ $V_{CE}=V_{IN}, I_{OUT}=30mA$	×0.99	$V_{OUT(T)}$ (3)	×1.01	V	①
		High Speed Mode (HS) $0.8V \leq V_{OUT(T)} \leq 1.95V$ $V_{CE}=V_{IN}, I_{OUT}=30mA$	-0.02		+0.02		
		Power Save Mode (PS) $2.0V \leq V_{OUT(T)} \leq 5.0V$ $V_{CE}=V_{IN}, I_{OUT}=0.1mA$	×0.98		×1.02		
		Power Save Mode (PS) $0.8V \leq V_{OUT(T)} \leq 1.95V$ $V_{CE}=V_{IN}, I_{OUT}=0.1mA$	-0.04		+0.04		
Output Current	I_{OUTMAX}	High Speed Mode(HS), $V_{CE}=V_{IN}$ $V_{IN}=V_{OUT(T)}+1.0V$ $0.8V \leq V_{OUT(T)} \leq 1.15V$	700	1200	-	mA	①
		High Speed Mode(HS), $V_{CE}=V_{IN}$ $V_{IN}=V_{OUT(T)}+1.0V$ $1.2V \leq V_{OUT(T)} \leq 5.0V$	1000	1200	-		
Load Regulation	ΔV_{OUT}	High Speed Mode (HS), $V_{CE}=V_{IN}$ $10mA \leq I_{OUT} \leq 300mA$	-	10	45	mV	①
Dropout Voltage1 ^(*)	Vdif	High Speed Mode (HS) $I_{OUT}=300mA, V_{CE}=V_{IN}$	see the Voltage Chart			mV	①
Dropout Voltage2 ^(*)	Vdif	High Speed Mode(HS) $I_{OUT}=1000mA, V_{CE}=V_{IN}$	see the Voltage Chart			mV	①
Supply Current 1	I_{SS1}	High Speed Mode(HS) $V_{IN}=V_{CE}=V_{OUT(T)}+1.0V$ $I_{OUT}=10mA$ (A/B Series)	-	50	108	μA	②
		High Speed Mode(HS) $V_{IN}=V_{CE}=V_{OUT(T)}+1.0V$ $I_{OUT}=10mA$ (C/D Series)	-	50	see the Voltage Chart		
Supply Current 2	I_{SS2}	Power Save Mode(PS) $V_{IN}=V_{CE}=V_{OUT(T)}+1.0V$ $I_{OUT}=0.1mA$	-	8	18	μA	②
		Power Save Mode(PS) $V_{IN}=V_{CE}=V_{OUT(T)}+1.0V$ $I_{OUT}=0.1mA$	-	8	see the Voltage Chart		
Stand-by Current	I_{STBY}	$V_{IN}=6.0V, V_{CE}=V_{SS}$	-0.1	0.01	0.1	μA	②
Line Regulation	$\frac{\Delta V_{OUT}}{(\Delta V_{IN} \cdot V_{OUT})}$	$V_{OUT(T)}+0.5V \leq V_{IN} \leq 6.0V$: $1.1V \leq V_{OUT(T)} \leq 5.0V$ High Speed Mode (HS), $V_{CE}=V_{IN}$ $I_{OUT}=100mA$	-	0.01	0.20	%V	①
		$1.6V \leq V_{IN} \leq 6.0V$: $0.8V \leq V_{OUT(T)} \leq 1.05V$ High Speed Mode (HS), $V_{CE}=V_{IN}$ $I_{OUT}=100mA$					
Input Voltage	V_{IN}		1.6	-	6.0	V	
Output Voltage Temperature Characteristics	$\frac{\Delta V_{OUT}}{(\Delta Ta \cdot V_{OUT})}$	High Speed Mode (HS), $V_{CE}=V_{IN}$ $I_{OUT}=30mA$ $-40^\circ C \leq Ta \leq 85^\circ C$	-	±100	-	ppm/°C	①

ELECTRICAL CHARACTERISTICS (Continued)

PARAMETER	SYMBOL	CONDITIONS	MIN.	TYP.	MAX.	UNITS	CIRCUIT
Ripple Rejection Rate	PSRR	$V_{IN}=5.75V_{DC}+0.5V_{p-pAC}$: $4.75V \leq V_{OUT(T)} \leq 5.0V$ High Speed Mode (HS), $V_{CE}=V_{IN}$ $I_{OUT}=30mA$, $f=1kHz$					
		$V_{IN}=\{V_{OUT(T)}+1.0\}$ $V_{DC}+0.5V_{p-pAC}$: $0.85V \leq V_{OUT(T)} \leq 4.7V$ High Speed Mode (HS), $V_{CE}=V_{IN}$ $I_{OUT}=30mA$, $f=1kHz$	-	50	-	dB	③
		$V_{IN}=1.85V_{DC}+0.5V_{p-pAC}$: $V_{OUT(T)}=0.8V$ High Speed Mode (HS), $V_{CE}=V_{IN}$ $I_{OUT}=30mA$, $f=1kHz$					
Limit Current	I_{LIM}	$V_{CE}=V_{IN}=V_{OUT(T)}+1.0V$ $0.8V \leq V_{OUT(T)} \leq 1.15V$	705	1200	-	mA	①
		$V_{CE}=V_{IN}$ $V_{IN}=V_{OUT(T)}+1.0V$ $1.2V \leq V_{OUT(T)} \leq 5.0V$	1005	1200	-		
Short Current	I_{SHORT}	$V_{CE}=V_{IN}$ Short V_{OUT} to V_{SS} level	-	180	-	mA	①
PS Switching Current	I_{GOR}	: $1.45V \leq V_{OUT(T)} \leq 5.0V$ $V_{IN}=V_{OUT(T)}+1.0V$, $V_{CE}="H"$ Level : $0.8V \leq V_{OUT(T)} \leq 1.4V$ $V_{IN}=1.6V$, $V_{CE}="H"$ Level $I_{OUT}=\text{heavy to light load}$	1.0	2.0	-	mA	⑤
HS Switching Current	I_{GO}	: $1.45V \leq V_{OUT(T)} \leq 5.0V$ $V_{IN}=V_{OUT(T)}+1.0V$, $V_{CE}="H"$ Level : $0.8V \leq V_{OUT(T)} \leq 1.4V$ $V_{IN}=1.6V$, $V_{CE}="H"$ Level $I_{OUT}=\text{light to heavy load}$	-	5.0	10	mA	⑤
Switch Current Hysteresis Range	I_{GOhys}	$I_{GOhys}=I_{GO}-I_{GOR}$	-	3.0	-	mA	⑤
PS Switching Delay Time	t_{DPS}	$V_{CE}=V_{IN}=V_{OUT(T)}+1.0V$, (HS/PS Auto-Switching) Time until HS mode is changed-over to PS mode by I_{GOR} .	see the Voltage Chart			μs	⑤
CE High Level Voltage	V_{CEH}	$V_{CE}=V_{IN}$	1.2	-	6.0	V	④
CE Low Level Voltage	V_{CEL}	$V_{CE}=V_{SS}$	-	-	0.4	V	④
CE High Level Current	I_{CEH}	$V_{CE}=V_{IN}$ (A/B series)	-0.1	-	0.1	μA	④
		$V_{CE}=V_{IN}=6.0V$ (C/D series)	-	9	15	μA	
CE Low Level Current	I_{CEL}	$V_{CE}=V_{SS}$	-0.1	-	0.1	μA	④
CL Discharge Resistance ⁽⁷⁾	R_{DCHG}	$V_{IN}=6.0V$, $V_{OUT}=5.0V$, $V_{CE}=V_{SS}$	-	460	-	Ω	①
Thermal Shutdown Detect Temperature	T_{TSD}	Junction Temperature	-	150	-	$^{\circ}C$	
Thermal Shutdown Release Temperature	T_{TSR}	Junction Temperature	-	135	-	$^{\circ}C$	
Inrush Current	I_{RUSH}	$V_{IN}=V_{OUT(T)}+1.0V$, $C_L=22\mu F$ $V_{CE}=0V \rightarrow V_{OUT(T)}+1.0V$ (Only when rising and within 1ms)	-	-	700	mA	⑥

NOTE:

- *1: Unless otherwise stated, $V_{IN}=V_{OUT(T)}+1.0V$.
- *2: $V_{OUT(E)}$ = Effective output voltage (see the voltage chart)
(ie. The output voltage when " $V_{OUT(T)}+1.0V$ " is provided at the V_{IN} pin while maintaining a certain I_{OUT} value.
- *3: $V_{OUT(T)}$: Nominal output voltage
- *4: $V_{dif}=\{V_{IN1}^{(6)} - V_{OUT1}^{(5)}\}$
- *5: V_{OUT1} =A voltage equal to 98% of the $V_{OUT(T)}$ when an amply stabilized I_{OUT} $\{V_{OUT(T)}+1.0V\}$ is input in the HS mode.
- *6: V_{IN1} =The input voltage when V_{OUT1} appears as input voltage is gradually decreased.
- *7: For the XC6220B/D series only. The XC6220A/C series (semi-custom) discharges by resistors R1 and R2 only as shown in the block diagrams.
- *8: For the XC6220A/C series, output voltage rises when the IC is in the high temperature stand-by mode.

■ ELECTRICAL CHARACTERISTICS (Continued)

● Voltage Chart 1

NOMINAL OUTPUT VOLTAGE (V)	OUTPUT VOLTAGE 1 (HS Mode) (V)		OUTPUT VOLTAGE 2 (PS Mode) (V)		DROPOUT VOLTAGE 1 Vdif 1 (mV) I _{OUT} =300mA		DROPOUT VOLTAGE 2 Vdif 2 (mV) I _{OUT} =1000mA		SUPPLY CURRENT 1 (XC6220C/D) (μ A)	SUPPLY CURRENT 2 (XC6220C/D) (μ A)	PS SWITCH DELAY TIME (μ s)
	V _{OUT}		V _{OUT}		Vdif		Vdif		I _{SS1}	I _{SS2}	t _{DPS}
	V _{OUT(T)}	MIN.	MAX.	MIN.	MAX.	TYP.	MAX.	MAX.	MAX.	MAX.	MAX.
0.80	0.7800	0.8200	0.7600	0.8400	400	575	-	112.500	22.500	650	
0.85	0.8300	0.8700	0.8100	0.8900				112.625	22.625		
0.90	0.8800	0.9200	0.8600	0.9400				112.750	22.750		
0.95	0.9300	0.9700	0.9100	0.9900				112.875	22.875		
1.00	0.9800	1.0200	0.9600	1.0400	240	405		113.000	23.000		
1.05	1.0300	1.0700	1.0100	1.0900				113.125	23.125		
1.10	1.0800	1.1200	1.0600	1.1400				180	305		113.250
1.15	1.1300	1.1700	1.1100	1.1900	113.375	23.375					
1.20	1.1800	1.2200	1.1600	1.2400	150	215		460	113.500		23.500
1.25	1.2300	1.2700	1.2100	1.2900					113.625		23.625
1.30	1.2800	1.3200	1.2600	1.3400			113.750		23.750		
1.35	1.3300	1.3700	1.3100	1.3900			113.875		23.875		
1.40	1.3800	1.4200	1.3600	1.4400			114.000		24.000		
1.45	1.4300	1.4700	1.4200	1.4800			114.125		24.125		
1.50	1.4800	1.5200	1.4700	1.5300	100	150	655	114.250	24.250		
1.55	1.5300	1.5700	1.5100	1.5900				114.375	24.375		
1.60	1.5800	1.6200	1.5600	1.6400				114.500	24.500		
1.65	1.6300	1.6700	1.6100	1.6900				114.625	24.625		
1.70	1.6800	1.7200	1.6600	1.7400				114.750	24.750		
1.75	1.7300	1.7700	1.7100	1.7900				114.875	24.875		
1.80	1.7800	1.8200	1.7600	1.8400	85	130	115.000	25.000			
1.85	1.8300	1.8700	1.8100	1.8900			115.125	25.125			
1.90	1.8800	1.9200	1.8600	1.9400			115.250	25.250			
1.95	1.9300	1.9700	1.9100	1.9900			115.375	25.375			
2.00	1.9800	2.0200	1.9600	2.0400			115.500	25.500			
2.05	2.0295	2.0705	2.0090	2.0910			115.625	25.625			
2.10	2.0790	2.1210	2.0580	2.1420			115.750	25.750			
2.15	2.1285	2.1715	2.1070	2.1930			115.875	25.875			
2.20	2.1780	2.2220	2.1560	2.2440			116.000	26.000			
2.25	2.2275	2.2725	2.2050	2.2950			116.125	26.125			
2.30	2.2770	2.3230	2.2540	2.3460	116.250	26.250					
2.35	2.3265	2.3735	2.3030	2.3970	116.375	26.375					
2.40	2.3760	2.4240	2.3520	2.4480	116.500	26.500					
2.45	2.4255	2.4745	2.4010	2.4990	116.625	26.625					
2.50	2.4750	2.5250	2.4500	2.5500	116.750	26.750					
2.55	2.5245	2.5755	2.4990	2.6010	116.875	26.875					
2.60	2.5740	2.6260	2.5480	2.6520	117.000	27.000					
2.65	2.6235	2.6765	2.5970	2.7030	117.125	27.125					
2.70	2.6730	2.7270	2.6460	2.7540	117.250	27.250					
2.75	2.7225	2.7775	2.6950	2.8050	117.375	27.375					
2.80	2.7720	2.8280	2.7440	2.8560	117.500	27.500					
2.85	2.8215	2.8785	2.7930	2.9070	117.625	27.625					
2.90	2.8710	2.9290	2.8420	2.9580	117.750	27.750					
2.95	2.9205	2.9795	2.8910	3.0090	117.875	27.875					
					65	110	655	117.000	27.000	1200	
								117.125	27.125		
								117.250	27.250		
								117.375	27.375		
								117.500	27.500		
								117.625	27.625		
					117.750	27.750					
					117.875	27.875					

ELECTRICAL CHARACTERISTICS (Continued)

● Voltage Chart 2

NOMINAL OUTPUT VOLTAGE (V)	OUTPUT VOLTAGE (HS Mode) (V)		OUTPUT VOLTAGE (PS Mode) (V)		DROPOUT VOLTAGE 1 Vdif 1 (mV) I _{OUT} =300mA		DROPOUT VOLTAGE 2 Vdif 2 (mV) I _{OUT} =1000mA		SUPPLY CURRENT 1 (XC6220C/D) (μ A)	SUPPLY CURRENT 2 (XC6220C/D) (μ A)	PS SWITCH DELAY TIME (μ s)
	V _{OUT}		V _{OUT}		Vdif		Vdif		I _{SS1}	I _{SS2}	t _{DPS}
V _{OUT(T)}	MIN.	MAX.	MIN.	MAX.	TYP.	MAX.	MAX.		MAX.	MAX.	MAX.
3.00	2.9700	3.0300	2.9400	3.0600	60	95			118.000	28.000	1200
3.05	3.0195	3.0805	2.9890	3.1110					118.125	28.125	
3.10	3.0690	3.1310	3.0380	3.1620					118.250	28.250	
3.15	3.1185	3.1815	3.0870	3.2130					118.375	28.375	
3.20	3.1680	3.2320	3.1360	3.2640					118.500	28.500	
3.25	3.2175	3.2825	3.1850	3.3150					118.625	28.625	
3.30	3.2670	3.3330	3.2340	3.3660					118.750	28.750	
3.35	3.3165	3.3835	3.2830	3.4170					118.875	28.875	
3.40	3.3660	3.4340	3.3320	3.4680					119.000	29.000	
3.45	3.4155	3.4845	3.3810	3.5190					119.125	29.125	
3.50	3.4650	3.5350	3.4300	3.5700					119.250	29.250	
3.55	3.5145	3.5855	3.4790	3.6210					119.375	29.375	
3.60	3.5640	3.6360	3.5280	3.6720					119.500	29.500	
3.65	3.6135	3.6865	3.5770	3.7230					119.625	29.625	
3.70	3.6630	3.7370	3.6260	3.7740					119.750	29.750	
3.75	3.7125	3.7875	3.6750	3.8250					119.875	29.875	
3.80	3.7620	3.8380	3.7240	3.8760					120.000	30.000	
3.85	3.8115	3.8885	3.7730	3.9270					120.125	30.125	
3.90	3.8610	3.9390	3.8220	3.9780	120.250	30.250					
3.95	3.9105	3.9895	3.8710	4.0290	120.375	30.375					
4.00	3.9600	4.0400	3.9200	4.0800	120.500	30.500					
4.05	4.0095	4.0905	3.9690	4.1310	120.625	30.625					
4.10	4.0590	4.1410	4.0180	4.1820	120.750	30.750					
4.15	4.1085	4.1915	4.0670	4.2330	120.875	30.875					
4.20	4.1580	4.2420	4.1160	4.2840	121.000	31.000					
4.25	4.2075	4.2925	4.1650	4.3350	121.125	31.125					
4.30	4.2570	4.3430	4.2140	4.3860	121.250	31.250					
4.35	4.3065	4.3935	4.2630	4.4370	121.375	31.375					
4.40	4.3560	4.4440	4.3120	4.4880	121.500	31.500					
4.45	4.4055	4.4945	4.3610	4.5390	121.625	31.625					
4.50	4.4550	4.5450	4.4100	4.5900	121.750	31.750					
4.55	4.5045	4.5955	4.4590	4.6410	121.875	31.875					
4.60	4.5540	4.6460	4.5080	4.6920	122.000	32.000					
4.65	4.6035	4.6965	4.5570	4.7430	122.125	32.125					
4.70	4.6530	4.7470	4.6060	4.7940	122.250	32.250					
4.75	4.7025	4.7975	4.6550	4.8450	122.375	32.375					
4.80	4.7520	4.8480	4.7040	4.8960	122.500	32.500					
4.85	4.8015	4.8985	4.7530	4.9470	122.625	32.625					
4.90	4.8510	4.9490	4.8020	4.9980	122.750	32.750					
4.95	4.9005	4.9995	4.8510	5.0490	122.875	32.875					
5.00	4.9500	5.0500	4.9000	5.1000	123.000	33.000					
					655						
					53	85					1450

OPERATIONAL EXPLANATION

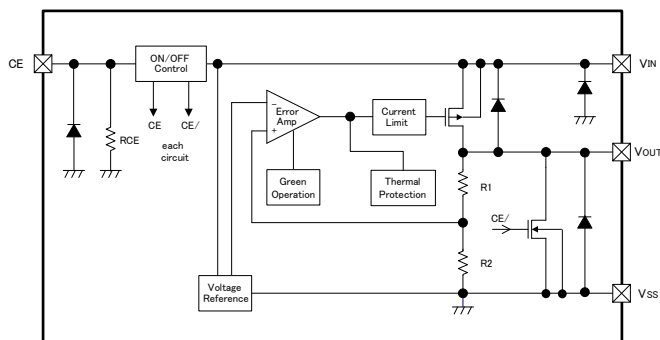

The voltage divided by resistors R1 & R2 is compared with the internal reference voltage by the error amplifier. The P-channel MOSFET which is connected to the V_{OUT} pin is then driven by the subsequent output signal. The output voltage at the V_{OUT} pin is controlled & stabilized by a system of negative feedback. The current limit circuit and short protect circuit operate in relation to the level of output current. The GO function monitors the output current and switches the IC between two operating modes according to the level of output current. Further, the IC's internal circuitry can be shutdown via the CE pin's signal.

<GreenOperation>

The XC6220 series always operates in a green operation (GO) mode. The GO mode enables the IC to switch automatically between the high speed (HS) mode or the power save (PS) mode according to the level of output current. The switching point of the HS mode and the PS mode is fixed inside the IC. When the output current becomes I_{GOR}=1.0mA (MIN.) or below, the mode changes automatically to the PS mode after a delay time of hundreds of microseconds. Supply current in light load is greatly reduced. Also when the output current becomes I_{GO} 10mA (MAX.) or more, the mode changes automatically to the HS mode and the IC returns to high speed operation.

<Low ESR capacitor>

The XC6220 series has a built-in phase compensation circuit which means that a stable output voltage is achieved even if the IC is used with low ESR capacitors. In order to ensure stable phase compensation it is recommended that a C_L capacitor is connected as close as possible to the V_{OUT} pin and V_{SS} pin. For a stable power supply, please connect an input capacitor (C_{IN}) between the V_{IN} pin and the V_{SS} pin.

Values required for the phase compensation are shown in the chart below. If a loss of the capacitance happens, the stable phase compensation may not be obtained. Please ensure to use a capacitor which does not depend on bias or temperature too much.

Recommended output capacitor (C_L) Values corresponding to input capacitor (C_{IN})

OUTPUT VOLTAGE (V)	INPUT CAPACITOR VALUE		
	4.7 μF	10 μF	22 μF
0.80V~0.95V	×	×	22 μF
1.00V~1.45V	47 μF	47 μF	22 μF
1.50V~1.75V	47 μF	22 μF	10 μF
1.80V~2.95V	47 μF	6.8 μF	6.8 μF
3.00V~3.50V	47 μF	4.7 μF	4.7 μF
3.55V~5.00V	47 μF	10 μF	6.8 μF

× No option

<Current Limiter, Short-Circuit Protection>

The XC6220 series includes a fold-back circuit, which aids the operation of the current limiter and circuit protection. When the load current reaches the current limit level, the fold-back circuit operates and output voltage drops. As a result of this drop in output voltage, output current also decreases. When the output pin is shorted, a current of about 180mA flows.

<CE Pin>

The IC's internal circuitry can be shutdown via the signal from the CE pin with the XC6220 series. With the XC6220B/D series, output at the V_{OUT} pin will be pulled down to the V_{SS} level. However, with XC6220A/B series, the C_L auto-discharge resistor is connected in parallel to R1 and R2 while the power supply is applied to the V_{IN} pin. Therefore, the time until the V_{OUT} pin reaches the V_{SS} level is shortened. The output voltage becomes unstable, when the CE pin is open. If this IC is used with the correct output voltage for the CE pin, the logic is fixed and the IC will operate normally. However, with the XC6220C/D series, supply current may increase as a result of through current in the IC's internal circuitry when medium voltage is input.

XC6220x301

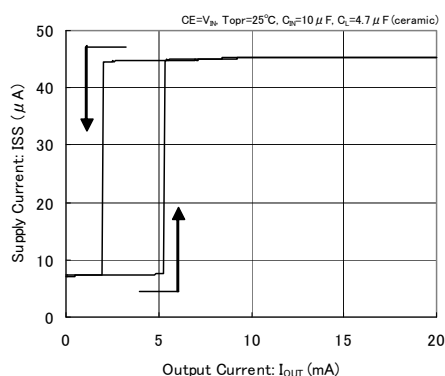

OPERATIONAL EXPLANATION (Continued)

<CL High Speed Auto-Discharge Function>

The XC6220B/D series can quickly discharge the electric charge at the output capacitor (C_L), when a low signal to the CE pin, which enables the whole IC circuit put into an OFF state, is inputted to the CE pin via the N-channel transistor located between the V_{OUT} pin and the V_{SS} pin (cf. BLOCK DIAGRAM). The C_L auto-discharge resistance value is fixed to $460\ \Omega$ ($V_{IN}=6.0V$, $V_{OUT}=5.0V$ at TYP.). The discharge time of the output capacitor (C_L) is set by the C_L auto-discharge resistance (R_{DCHG}) and the output capacitor (C_L). By setting a time constant of the C_L auto-discharge resistance value [R_{DCHG}] and an output capacitor value (C_L) as τ ($\tau = C \times R_{DCHG}$), the output voltage after discharge via the N channel transistor is calculated by the following formulas.

$$V = V_{OUT} \times e^{-t/\tau}, \quad \text{or } t = \tau \ln(V_{OUT(E)} / V)$$

where

V : Output voltage after discharge

$V_{OUT(E)}$: Output voltage

t : Discharge time

τ : C_L auto-discharge resistance R_{DCHG} \times Output capacitor (C_L) value C

For the XC6220A/C series, output voltage may rises when in the high stand-by mode. Please note that in that case, the typical characteristics may worse. When the XC6220A/C series is used, please be noted the characteristics shown below.

XC6220A501xx

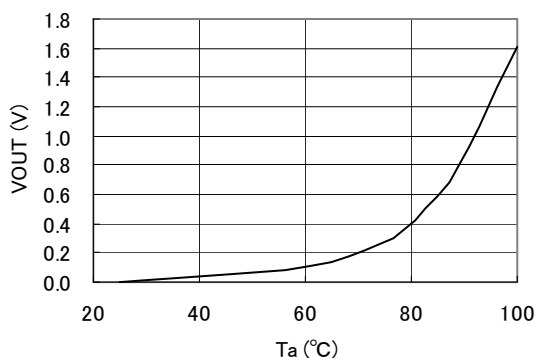

Output Voltage vs. Input Voltage

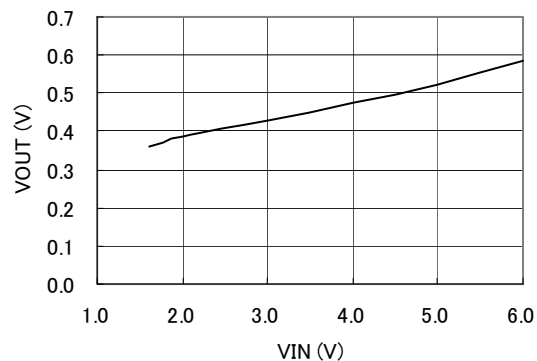

<Thermal Shutdown>

When the junction temperature of the built-in driver transistor reaches the temperature limit level (150°C TYP.), the thermal shutdown circuit operates and the driver transistor will be turned OFF. The IC resumes its operation when the thermal shutdown function is released and the IC's operation is automatically restored because the junction temperature drops to the level of the thermal shutdown release voltage.

<Inrush Current Protection>

The XC6220 series includes an inrush current protection circuit.

The inrush current protection circuit suppresses inrush current charged to C_L when the IC starts up to 700 mA (MAX.) for approximately 1 ms.

* Please note that the device can not provide the output current beyond 700 mA for a period of approximately 1 ms after the CE pin goes high.

NOTES ON USE

1. Please use this IC within the stated absolute maximum ratings. The IC is liable to malfunction should the ratings be exceeded.
2. Where wiring impedance is high, operations may become unstable due to noise and/or phase lag depending on output current. Please strengthen V_{IN} and V_{SS} wiring in particular.
3. Please wire the input capacitor (C_{IN}) and the output capacitor (C_L) as close to the IC as possible.

TEST CIRCUITS

Circuit 1: Output Voltage, Output Current, Dropout Voltage, Input/Operating Voltage, Line Regulation, Load Regulation, Current Limit, Short Current, CL Discharge Resistance

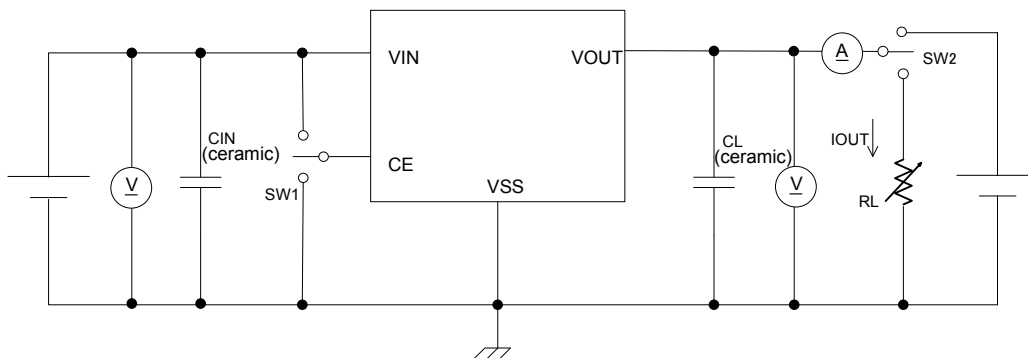

Circuit 2: Supply Current, Stand-by Current

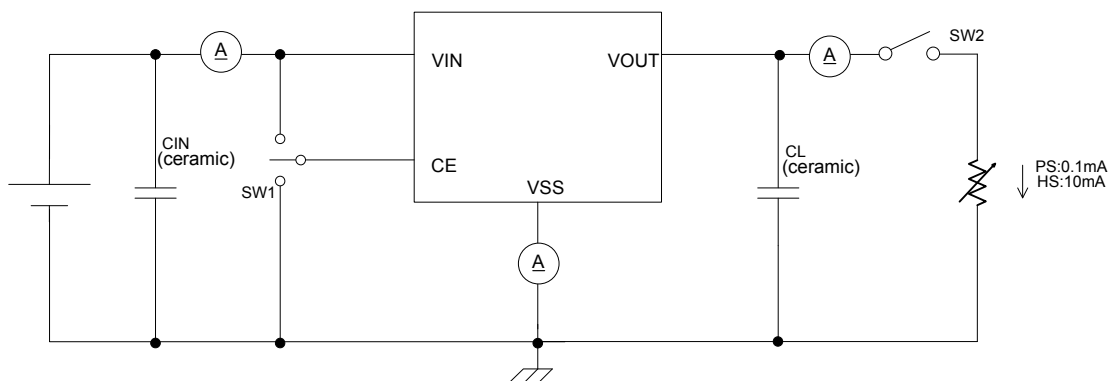

Circuit 3: Ripple Rejection Rate

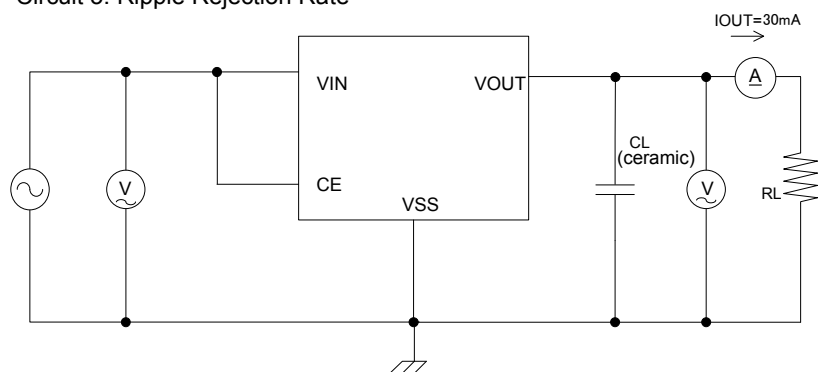

TEST CIRCUITS (Continued)

Circuit 4: CE "H" "L" Level Voltage, CE "H" "L" Level Current

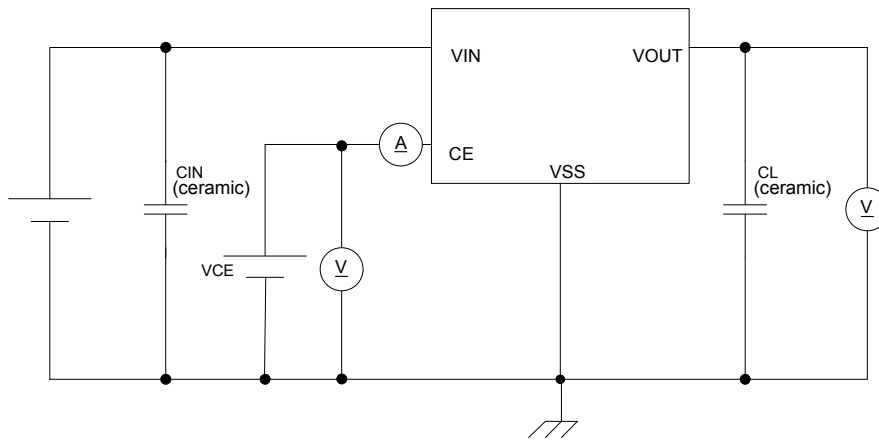

Circuit 5: HS Switching Current, PS Switching Current, Switch Current Hysteresis Range, PS Switching Delay Time

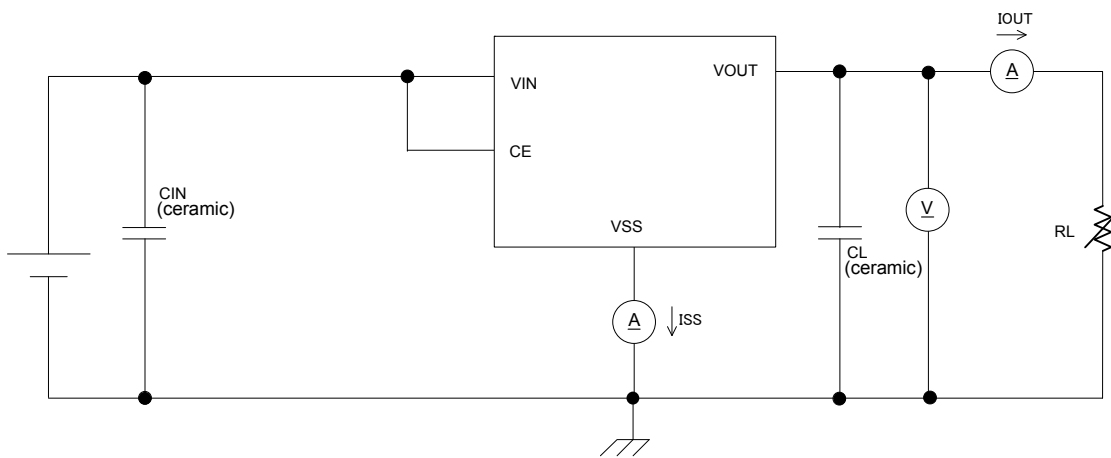

TYPICAL PERFORMANCE CHARACTERISTICS

(1) Output Voltage vs. Output Current

XC6220x121

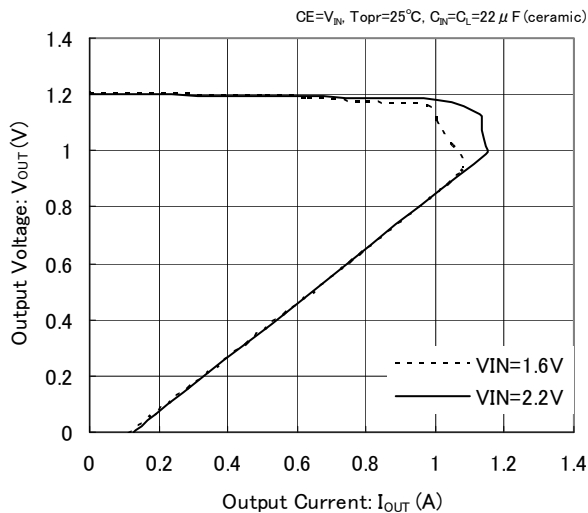

XC6220x121

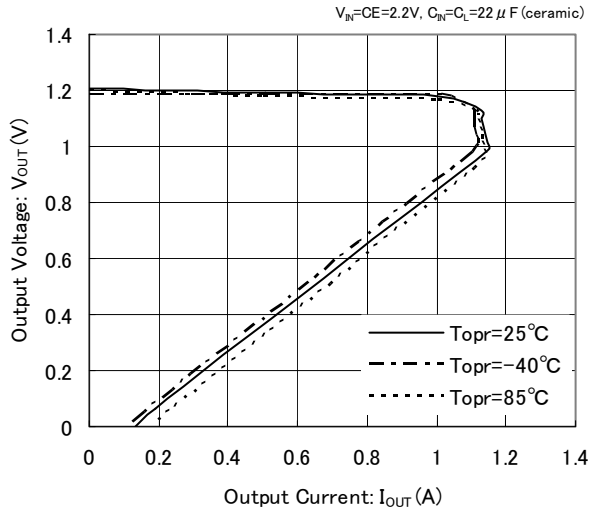

XC6220x301

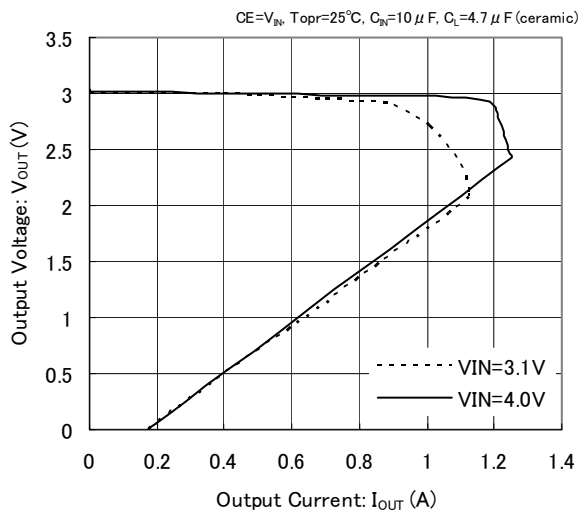

XC6220x301

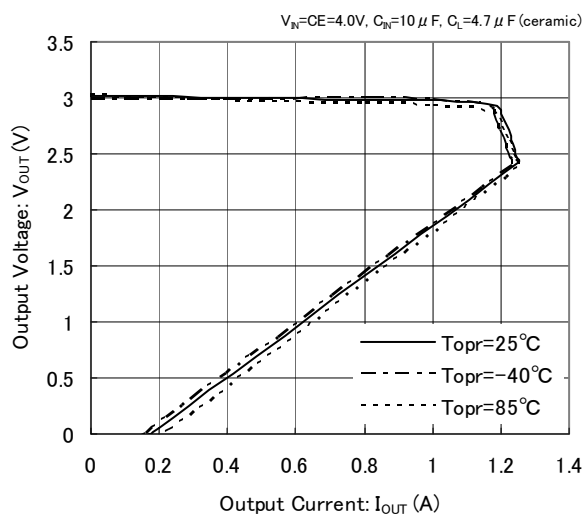

XC6220x501

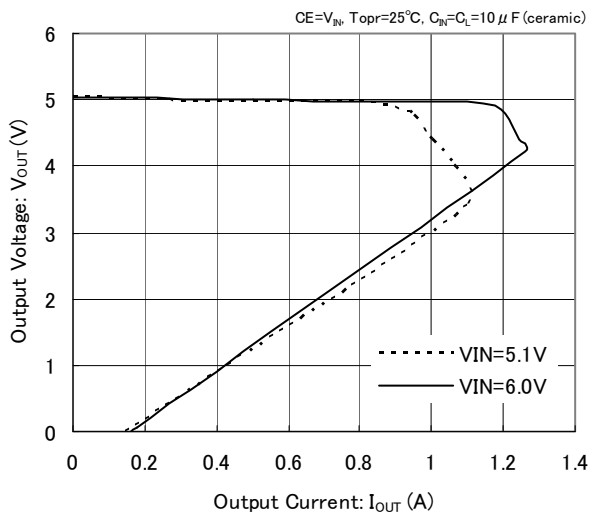

XC6220x501

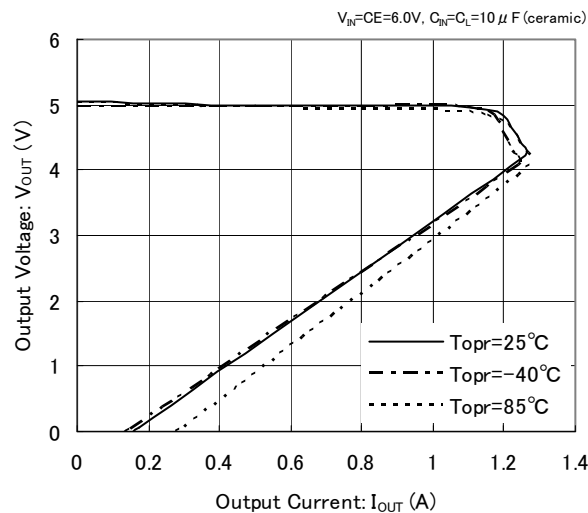

TYPICAL PERFORMANCE CHARACTERISTICS (Continued)

(2) Output Voltage vs. Input Voltage

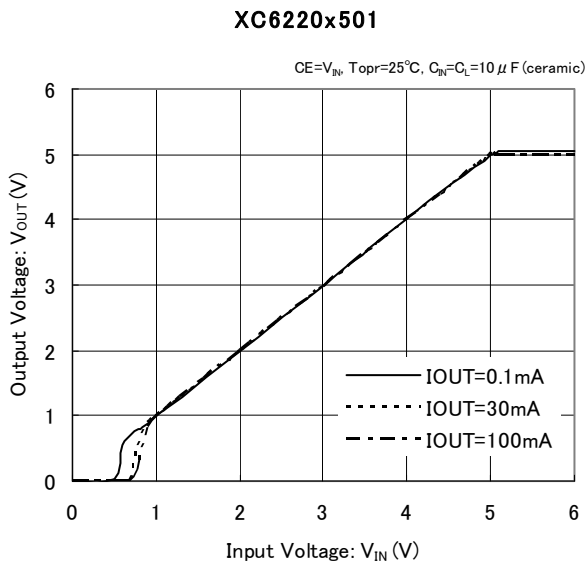
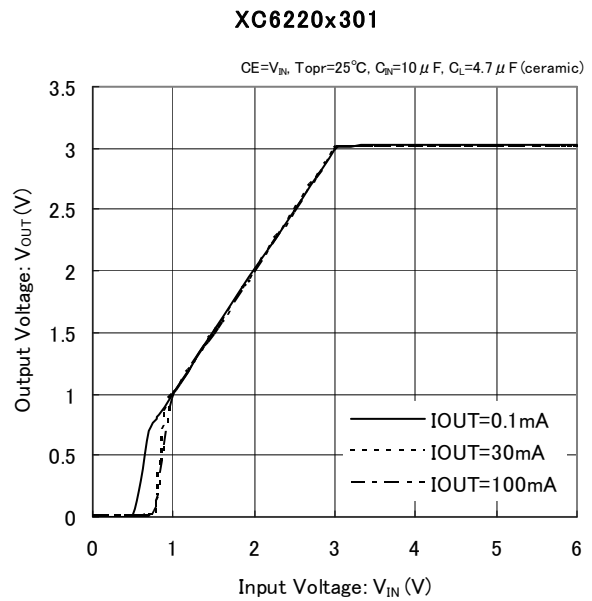
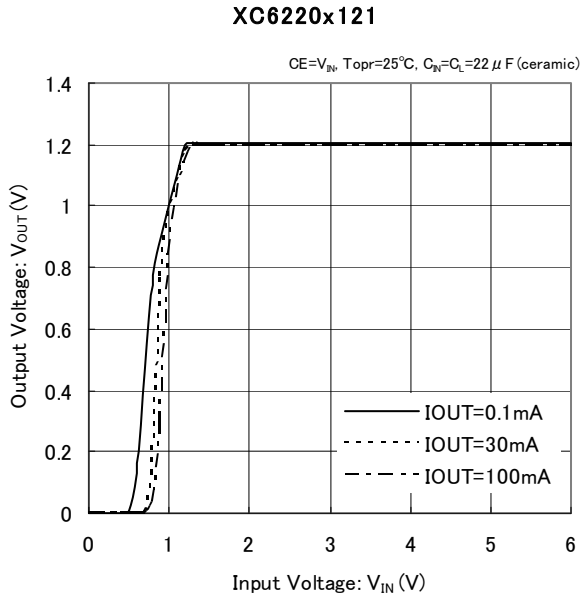

(3) Dropout Voltage vs. Output Current

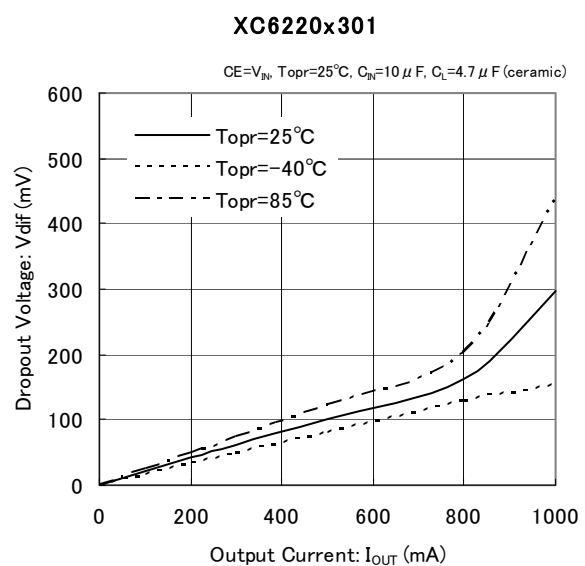
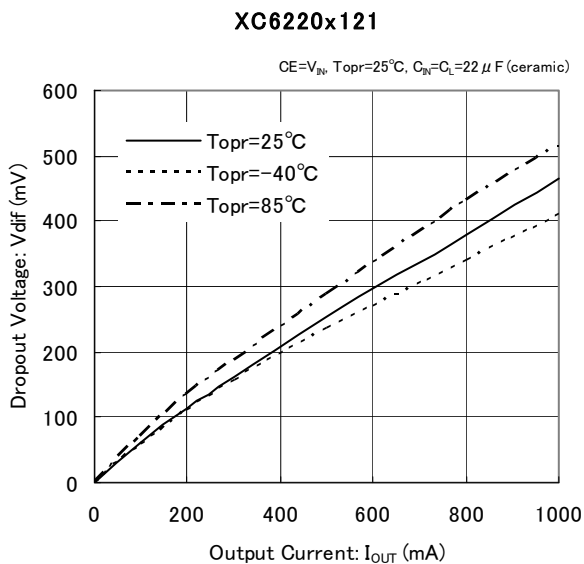

■ TYPICAL PERFORMANCE CHARACTERISTICS (Continued)

(3) Dropout Voltage vs. Output Current

XC6220x501

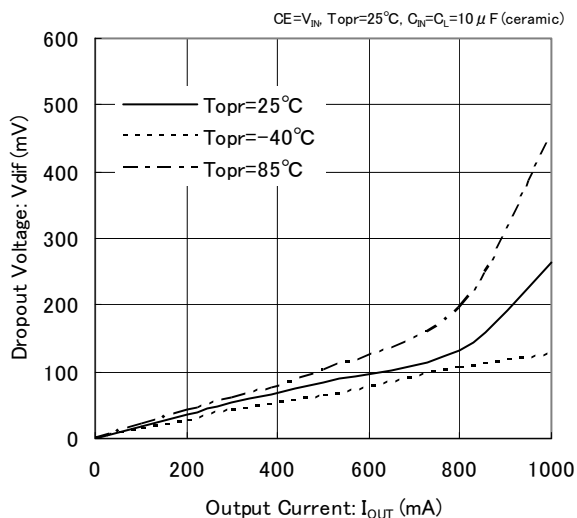

(4) Output Voltage vs. Ambient Temperature

XC6220x121

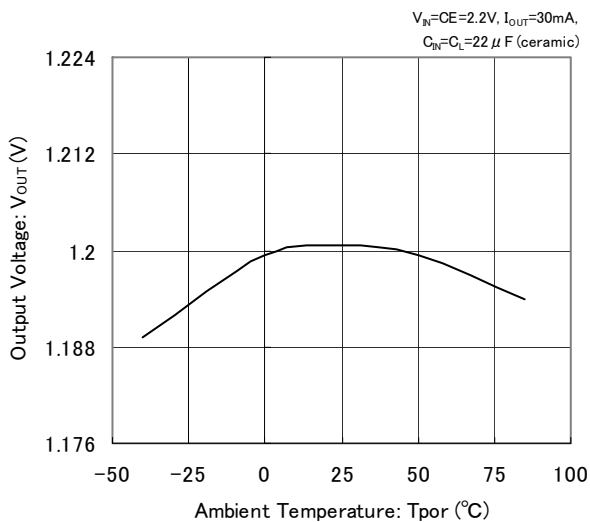

XC6220x301

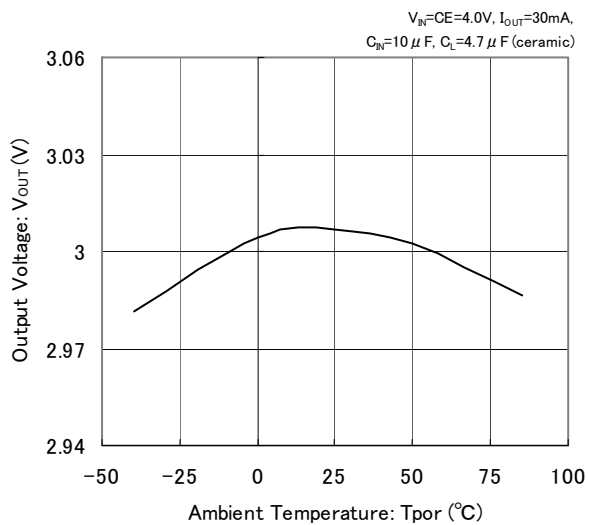

XC6220x501

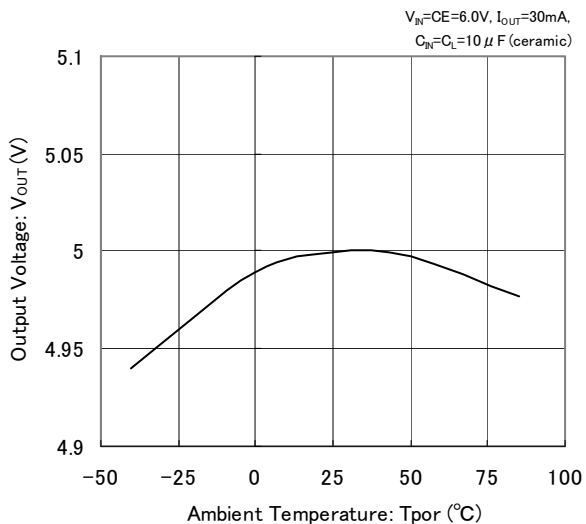

TYPICAL PERFORMANCE CHARACTERISTICS (Continued)

(5) Supply Current vs. Input Voltage

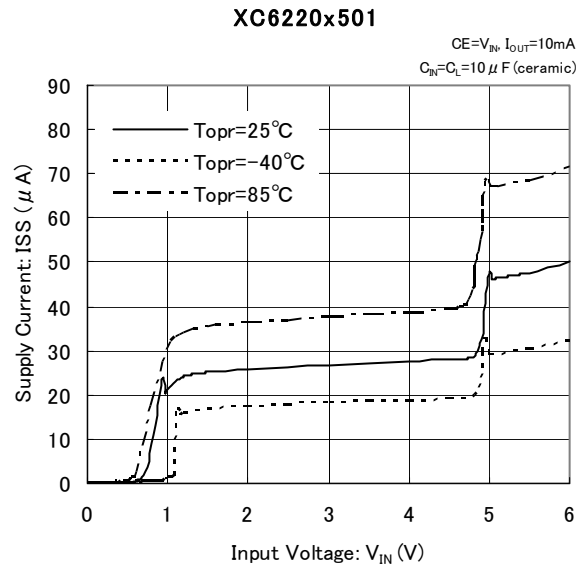
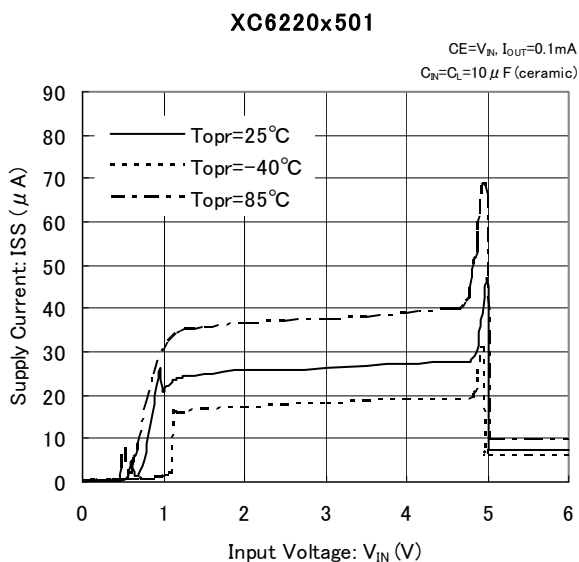
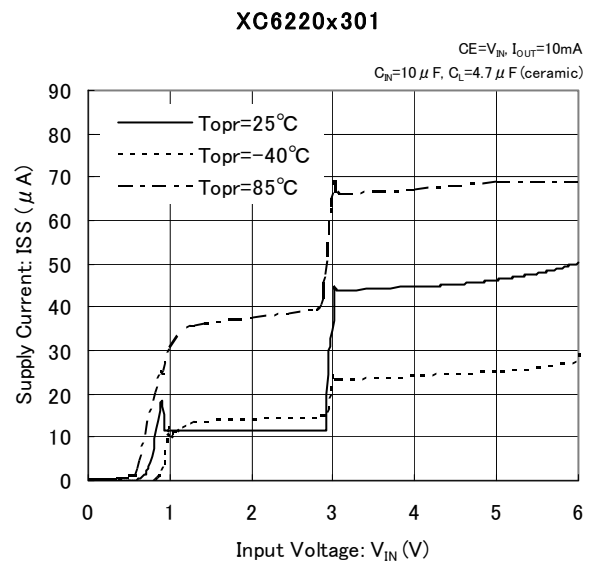
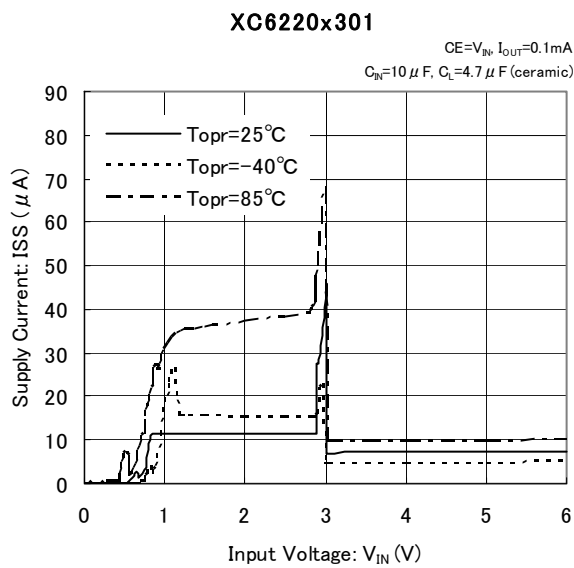
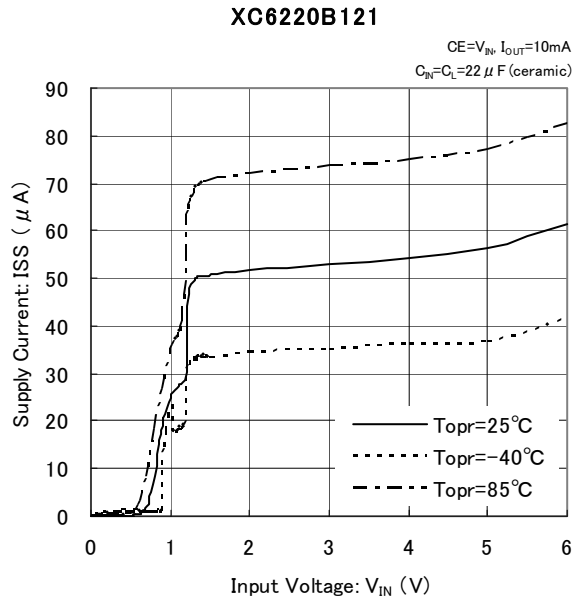
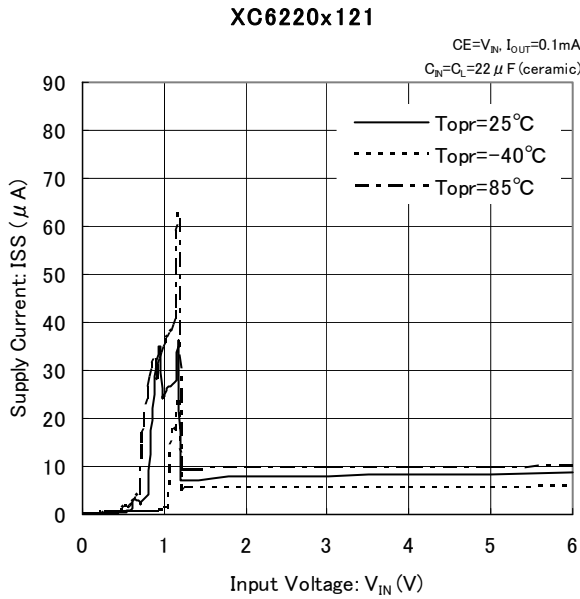

■ TYPICAL PERFORMANCE CHARACTERISTICS (Continued)

(6) PS Switching Delay Time vs. Ambient Temperature

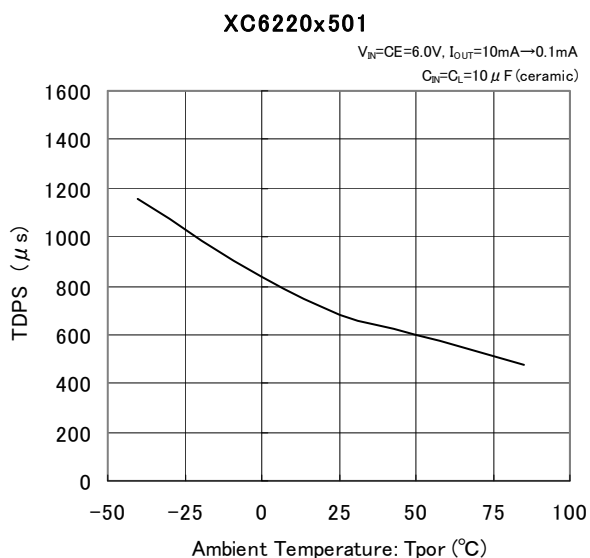
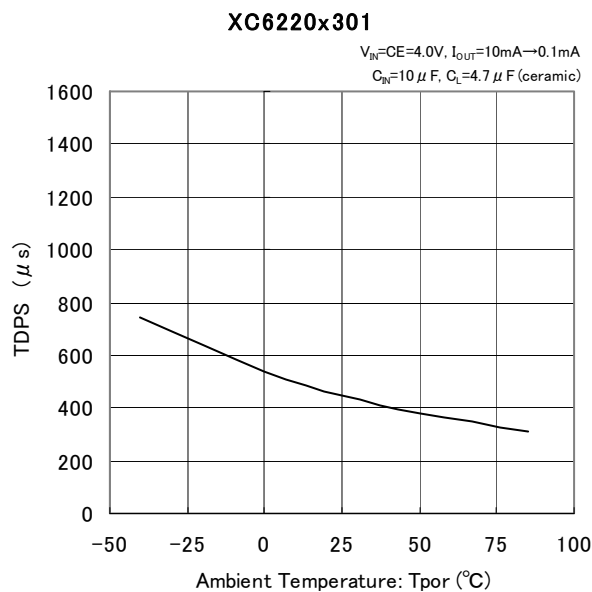
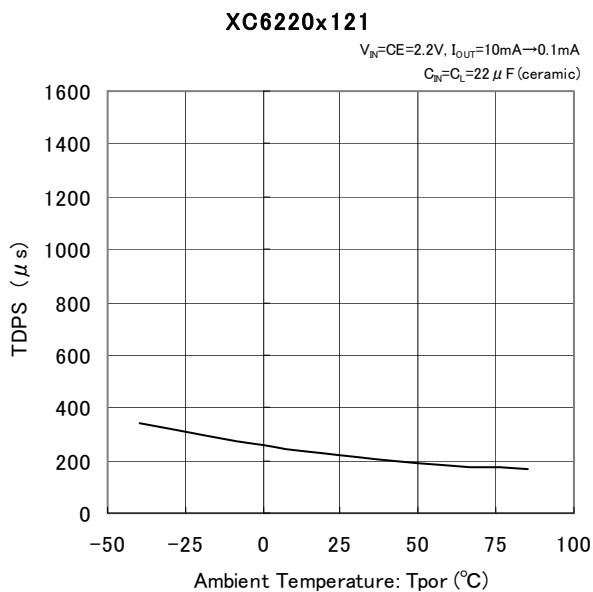

(7) CL Discharge Resistance vs. Ambient Temperature

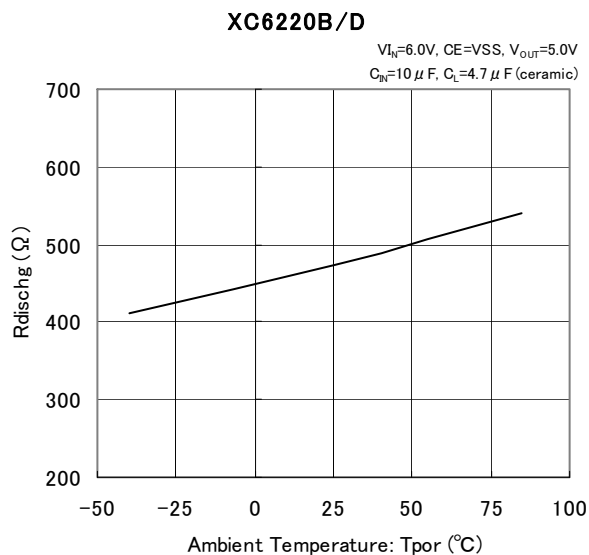

(8) PS/HS Switch Current vs. Ambient Temperature

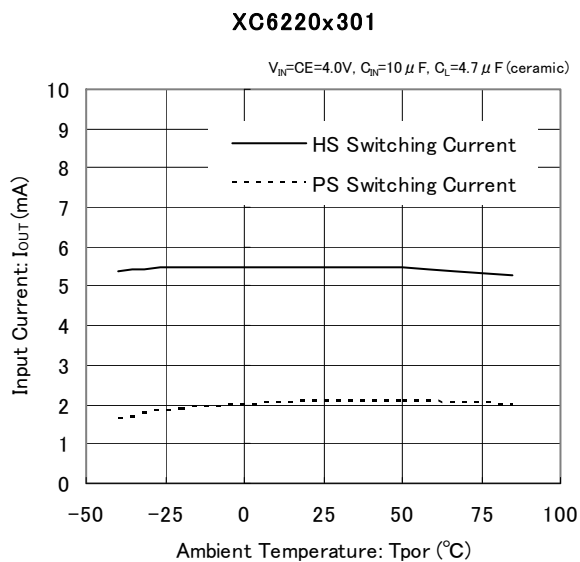

TYPICAL PERFORMANCE CHARACTERISTICS (Continued)

(9) Load Transient Response

XC6220x121

$V_{IN}=CE=2.2V$, $T_r=T_f=5\mu s$
 $T_{opr}=25^\circ C$, $C_N=C_L=22\mu F$ (ceramic)

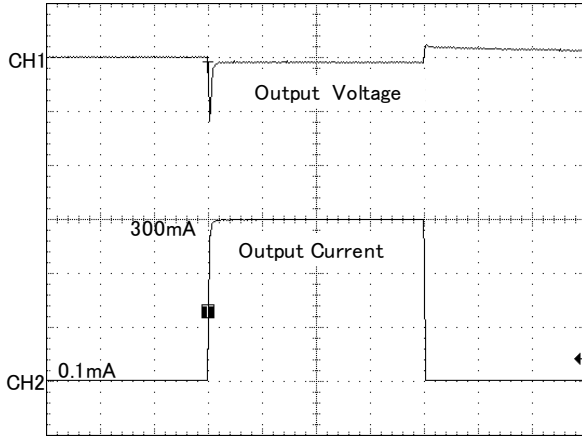

200 μs / div
 CH1 : 100mV / div CH2 : 100mA / div

XC6220x121

$V_{IN}=CE=2.2V$, $T_r=T_f=5\mu s$
 $T_{opr}=25^\circ C$, $C_N=C_L=22\mu F$ (ceramic)

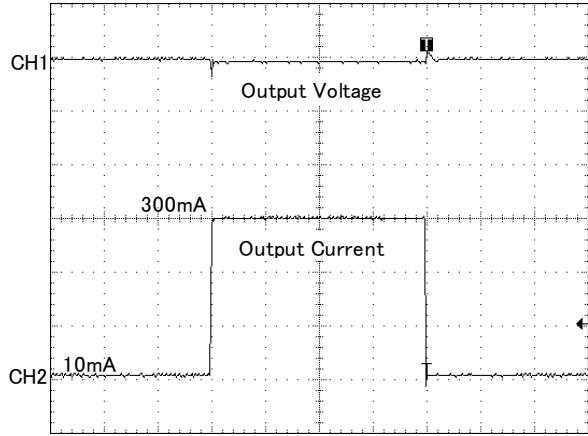

200 μs / div
 CH1 : 100mV / div CH2 : 100mA / div

XC6220x301

$V_{IN}=CE=4.0V$, $T_r=T_f=5\mu s$
 $T_{opr}=25^\circ C$, $C_N=10\mu F$, $C_L=4.7\mu F$ (ceramic)

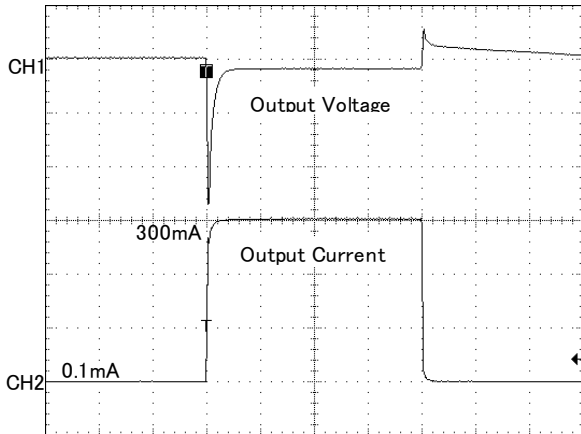

200 μs / div
 CH1 : 100mV / div CH2 : 100mA / div

XC6220x301

$V_{IN}=CE=4.0V$, $T_r=T_f=5\mu s$
 $T_{opr}=25^\circ C$, $C_N=10\mu F$, $C_L=4.7\mu F$ (ceramic)

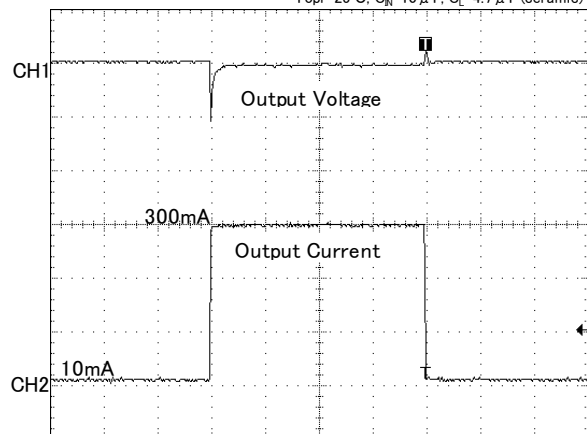

200 μs / div
 CH1 : 100mV / div CH2 : 100mA / div

XC6220x501

$V_{IN}=CE=6.0V$, $T_r=T_f=5\mu s$
 $T_{opr}=25^\circ C$, $C_N=C_L=10\mu F$ (ceramic)

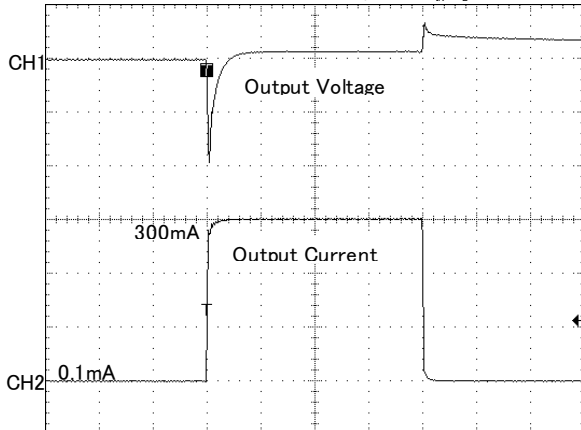

200 μs / div
 CH1 : 100mV / div CH2 : 100mA / div

XC6220x501

$V_{IN}=CE=6.0V$, $T_r=T_f=5\mu s$
 $T_{opr}=25^\circ C$, $C_N=C_L=10\mu F$ (ceramic)

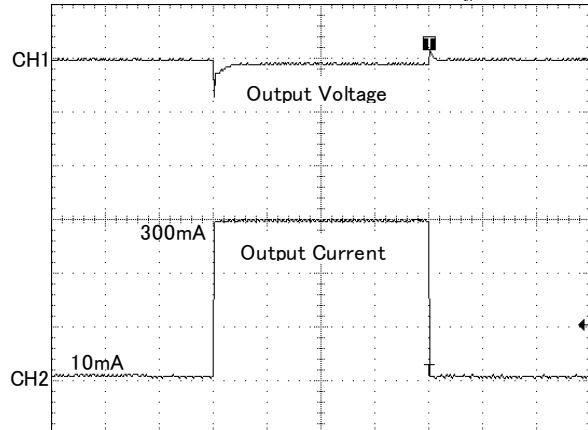

200 μs / div
 CH1 : 100mV / div CH2 : 100mA / div

■ TYPICAL PERFORMANCE CHARACTERISTICS (Continued)

(10) Line Transient Response

XC6220x121

CE=V_{IN}, Tr=Tf=5 μs, I_{OUI}=100mA
T_{opr}=25°C, C_{IN}=C_L=22 μF (ceramic)

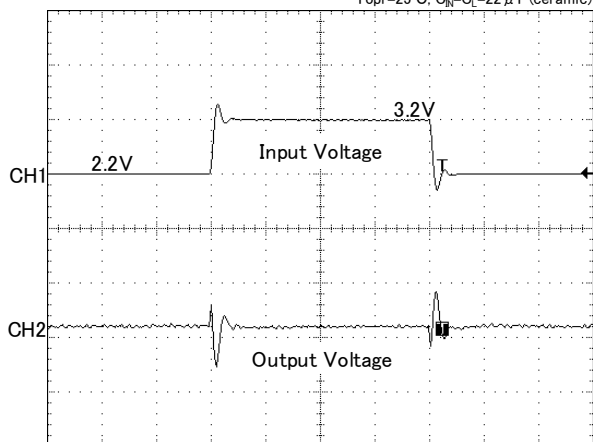

XC6220x301

CE=V_{IN}, Tr=Tf=5 μs, I_{OUI}=100mA
T_{opr}=25°C, C_{IN}=10 μF, C_L=4.7 μF (ceramic)

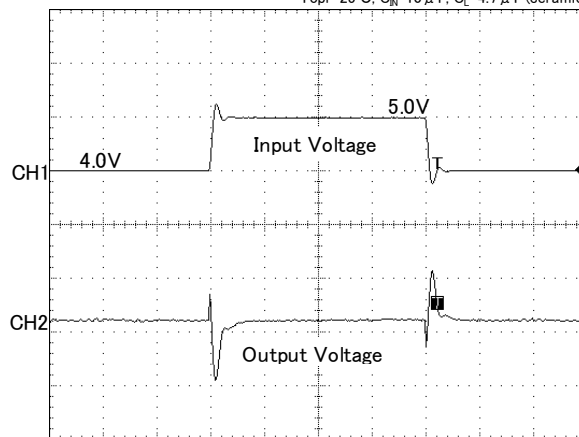

XC6220x501

CE=V_{IN}, Tr=Tf=5 μs, I_{OUI}=100mA
T_{opr}=25°C, C_{IN}=C_L=22 μF (ceramic)

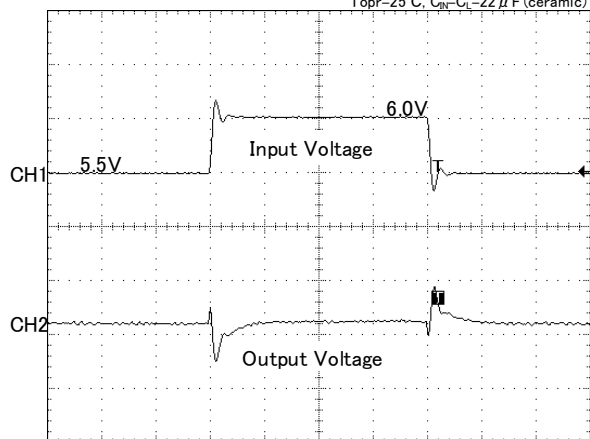

(11) Input Rise Characteristics

XC6220x121

CE=V_{IN}, Tr=5 μs, I_{OUI}=0.1mA
T_{opr}=25°C, C_L=22 μF (ceramic)

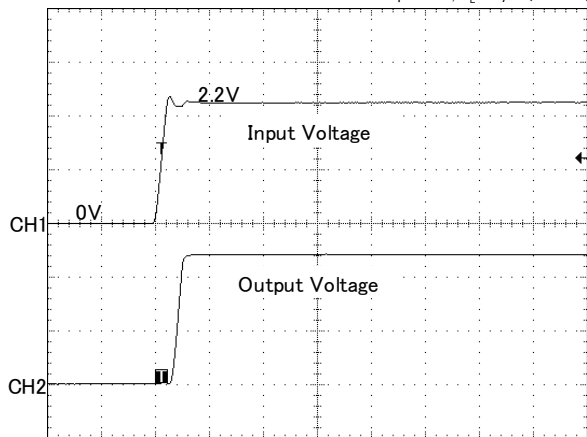

XC6220x121

CE=V_{IN}, Tr=5 μs, I_{OUI}=300mA
T_{opr}=25°C, C_L=22 μF (ceramic)

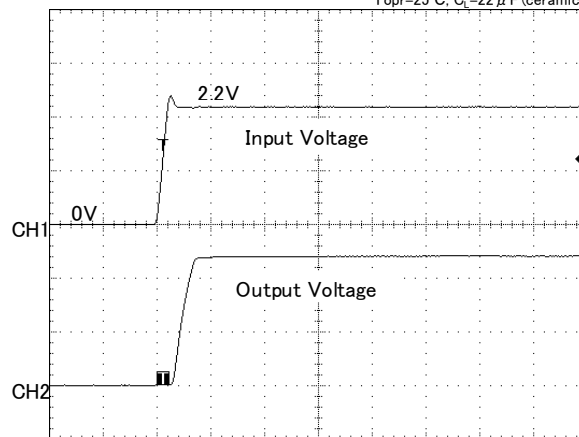

TYPICAL PERFORMANCE CHARACTERISTICS (Continued)

(11) Input Rise Characteristics

XC6220x301

$CE=V_{IN}$, $T_r=5\mu s$, $I_{OUT}=0.1mA$
 $T_{opr}=25^\circ C$, $C_L=4.7\mu F$ (ceramic)

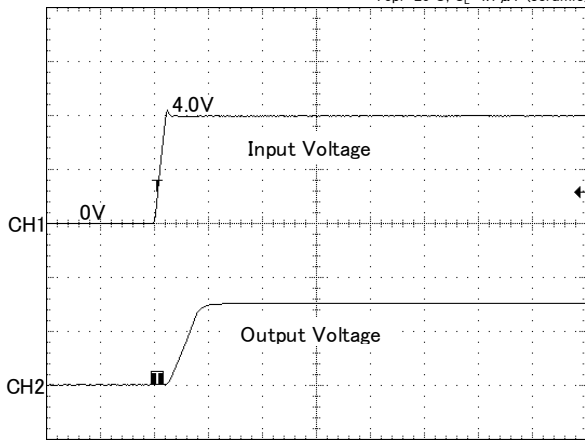

200 μs /div
 CH1 : 2V/div CH2 : 2V/div

XC6220x301

$CE=V_{IN}$, $T_r=5\mu s$, $I_{OUT}=300mA$
 $T_{opr}=25^\circ C$, $C_L=4.7\mu F$ (ceramic)

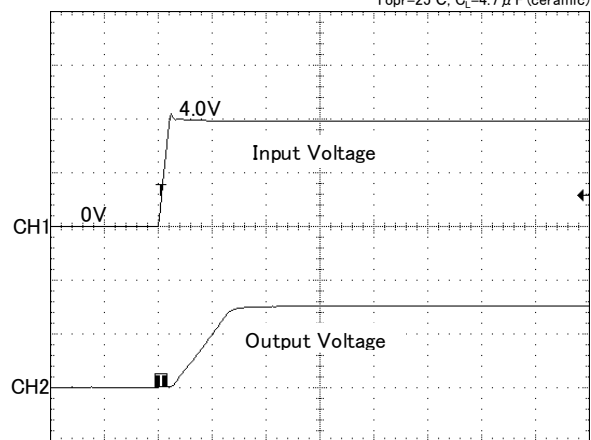

200 μs /div
 CH1 : 2V/div CH2 : 2V/div

XC6220x501

$CE=V_{IN}$, $T_r=5\mu s$, $I_{OUT}=0.1mA$
 $T_{opr}=25^\circ C$, $C_L=22\mu F$ (ceramic)

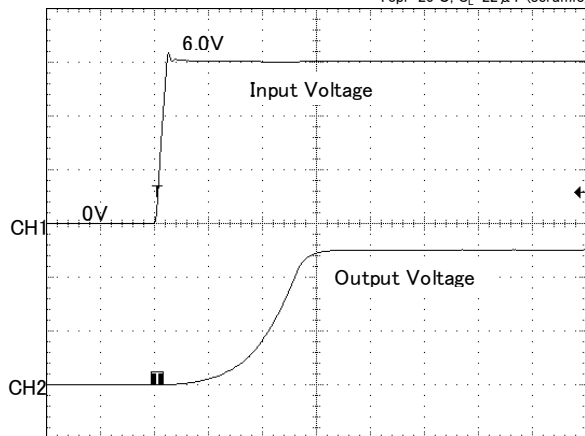

200 μs /div
 CH1 : 2V/div CH2 : 2V/div

XC6220x501

$CE=V_{IN}$, $T_r=5\mu s$, $I_{OUT}=300mA$
 $T_{opr}=25^\circ C$, $C_L=22\mu F$ (ceramic)

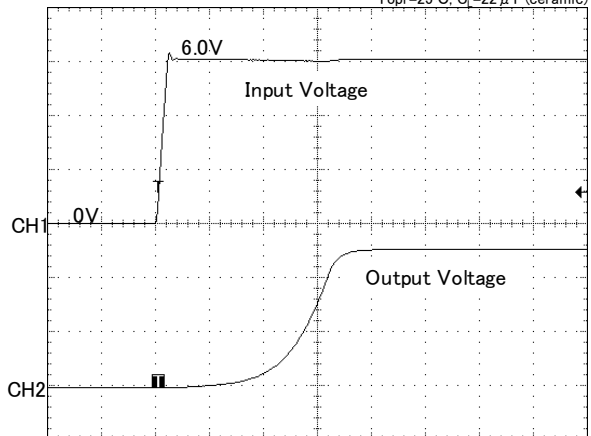

200 μs /div
 CH1 : 2V/div CH2 : 2V/div

(12) CE Rise Characteristics

XC6220x121

$V_{IN}=2.2V$, $T_r=5\mu s$, $I_{OUT}=0.1mA$
 $T_{opr}=25^\circ C$, $C_{IN}=C_L=22\mu F$ (ceramic)

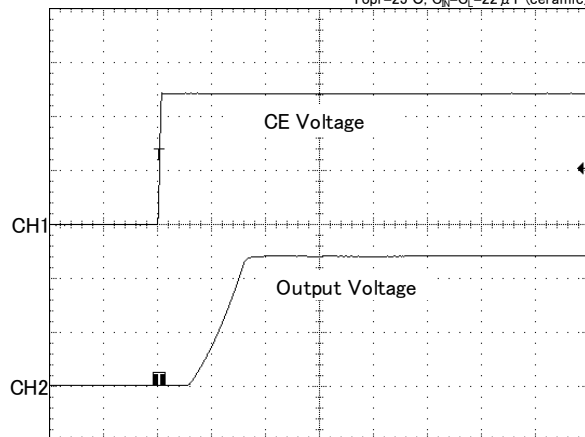

100 μs /div
 CH1 : 500mV/div CH2 : 500mV/div

XC6220x121

$V_{IN}=2.2V$, $T_r=5\mu s$, $I_{OUT}=300mA$
 $T_{opr}=25^\circ C$, $C_{IN}=C_L=22\mu F$ (ceramic)

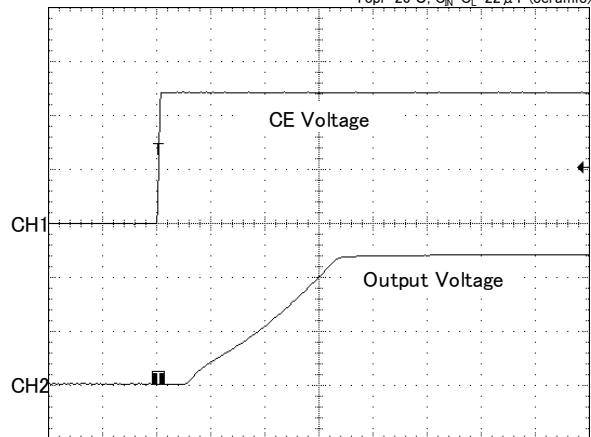

100 μs /div
 CH1 : 500mV/div CH2 : 500mV/div

■ TYPICAL PERFORMANCE CHARACTERISTICS (Continued)

(12) CE Rise Characteristics

XC6220x301

$V_{IN}=4.0V$, $T_r=5\mu s$, $I_{OUT}=0.1mA$
 $T_{opr}=25^\circ C$, $C_{IN}=10\mu F$, $C_L=4.7\mu F$ (ceramic)

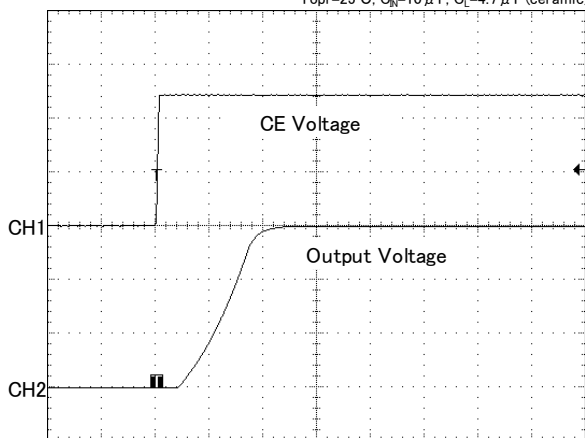

100 μs / div
CH1 : 500mV/div CH2 : 1V/div

XC6220x301

$V_{IN}=4.0V$, $T_r=5\mu s$, $I_{OUT}=300mA$
 $T_{opr}=25^\circ C$, $C_{IN}=10\mu F$, $C_L=4.7\mu F$ (ceramic)

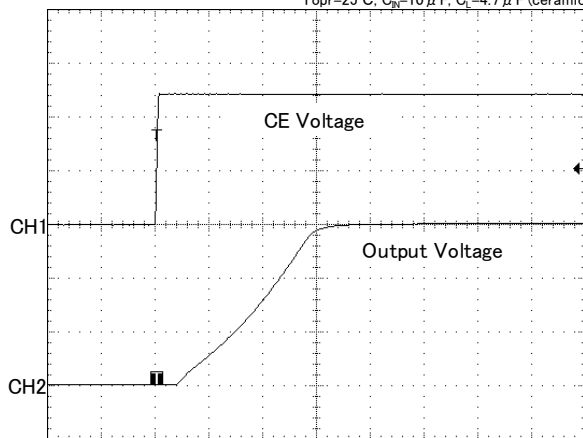

100 μs / div
CH1 : 500mV/div CH2 : 1V/div

XC6220x501

$V_{IN}=6.0V$, $T_r=5\mu s$, $I_{OUT}=0.1mA$
 $T_{opr}=25^\circ C$, $C_{IN}=C_L=10\mu F$ (ceramic)

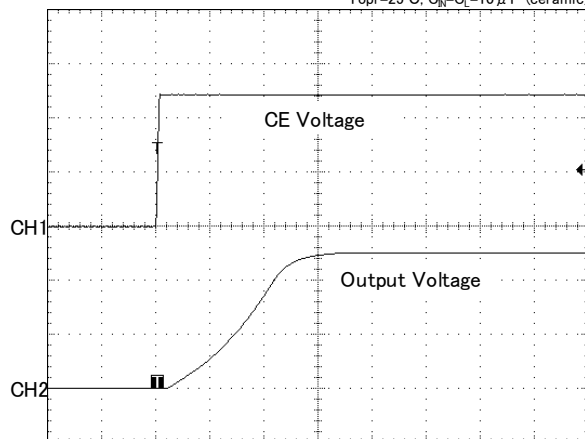

100 μs / div
CH1 : 500mV/div CH2 : 2V/div

XC6220x501

$V_{IN}=6.0V$, $T_r=5\mu s$, $I_{OUT}=300mA$
 $T_{opr}=25^\circ C$, $C_{IN}=C_L=10\mu F$ (ceramic)

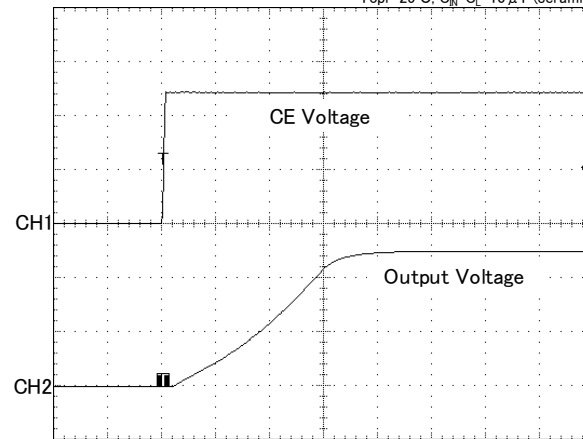

100 μs / div
CH1 : 500mV/div CH2 : 2V/div

(13) Inrush Current

XC6220x121

$V_{IN}=2.2V$, $T_r=5\mu s$
 $T_{opr}=25^\circ C$, $C_{IN}=C_L=22\mu F$ (ceramic)

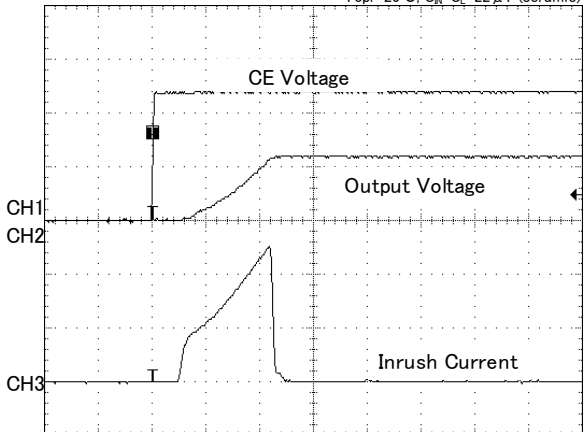

100 μs / div
CH1 : 500mV/div CH2 : 1V/div CH3 : 100mA/div

XC6220x301

$V_{IN}=4.0V$, $T_r=5\mu s$
 $T_{opr}=25^\circ C$, $C_{IN}=10\mu F$, $C_L=4.7\mu F$ (ceramic)

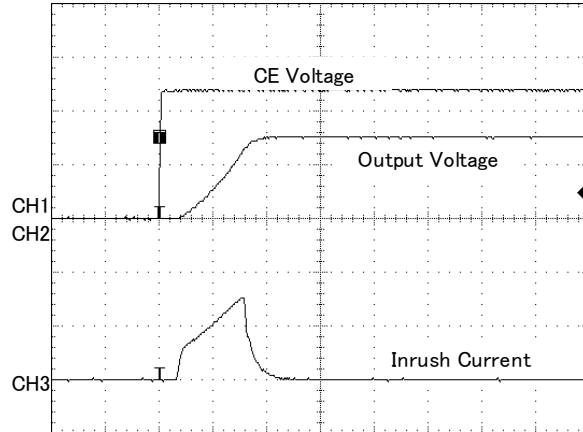

100 μs / div
CH1 : 500mV/div CH2 : 1V/div CH3 : 100mA/div

TYPICAL PERFORMANCE CHARACTERISTICS (Continued)

(13) Inrush Current

XC6220x501

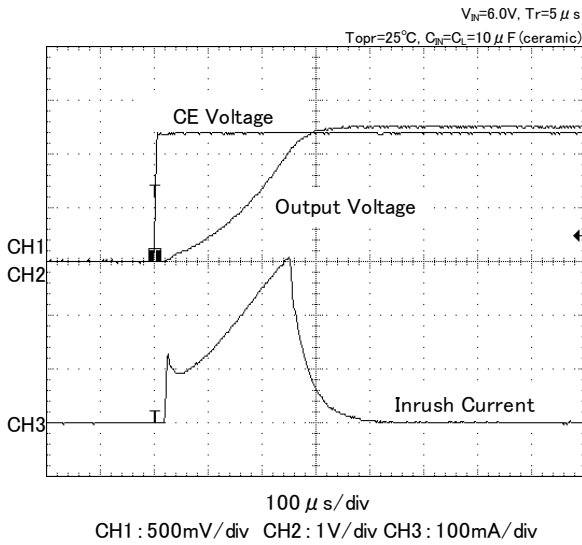

(14) CL Discharge Time

XC6220x301 (B/D)

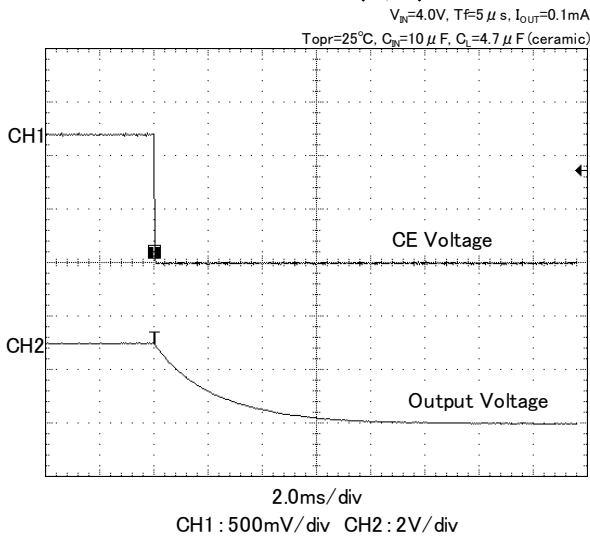

XC6220x301 (A/C)

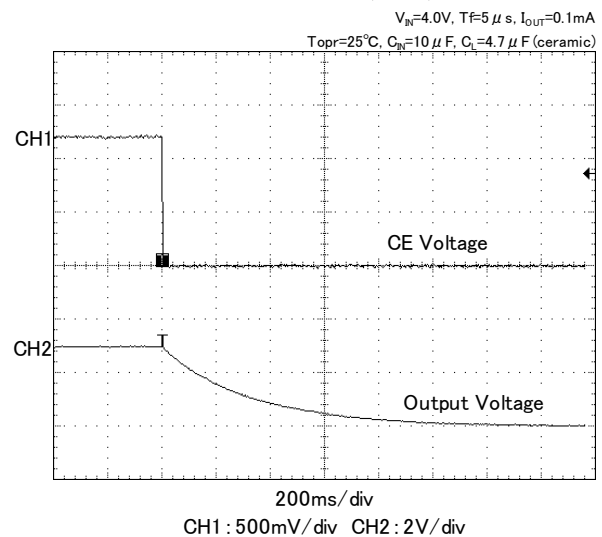

(15) Ripple Rejection Rate

XC6220x121 (HighSpeed mode)

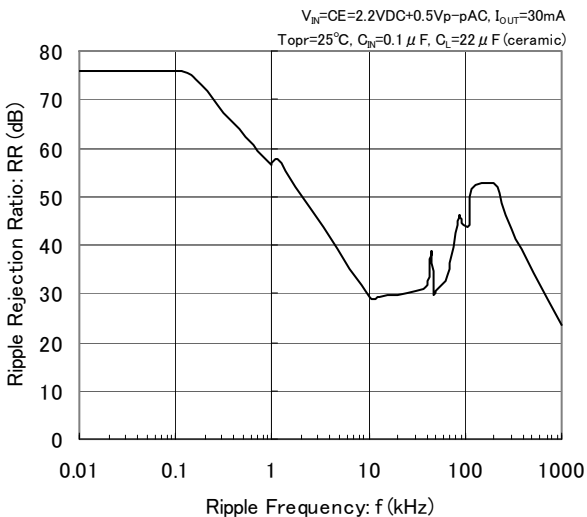

XC6220x121 (PowerSave mode)

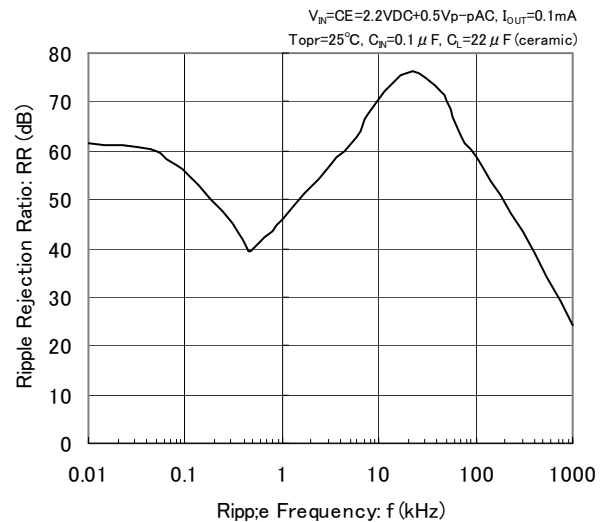

■ TYPICAL PERFORMANCE CHARACTERISTICS (Continued)

(15) Ripple Rejection Rate

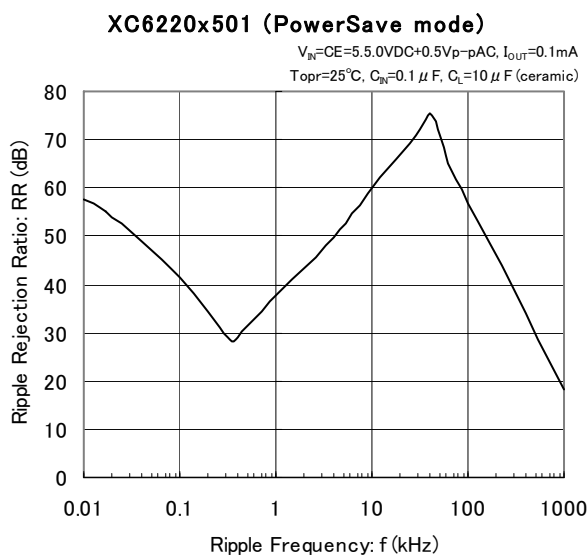
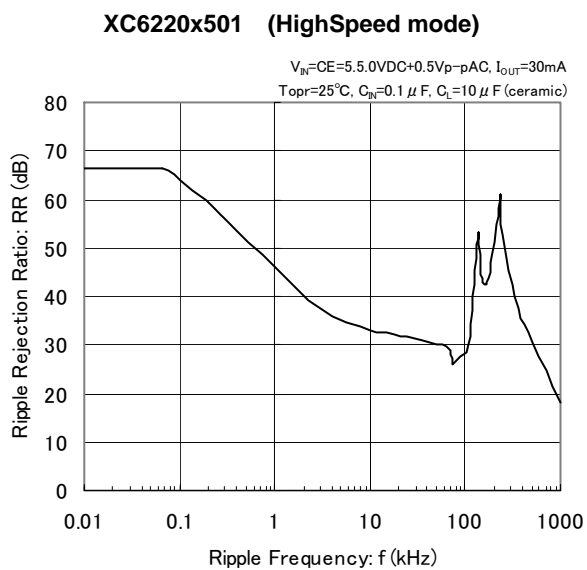
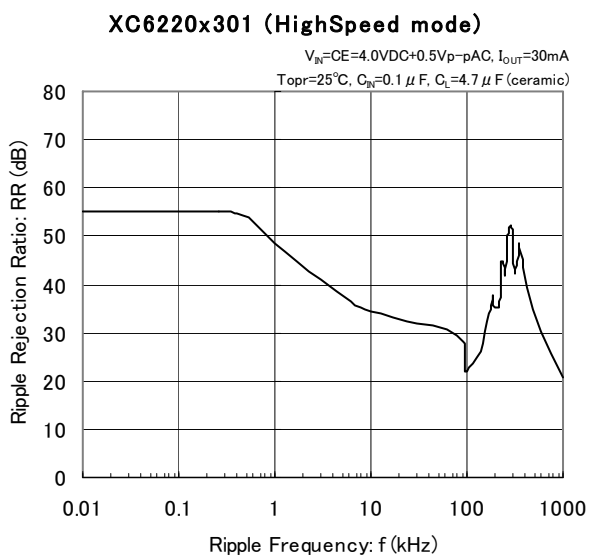

PACKAGING INFORMATION

● USP-6C

(unit : mm)

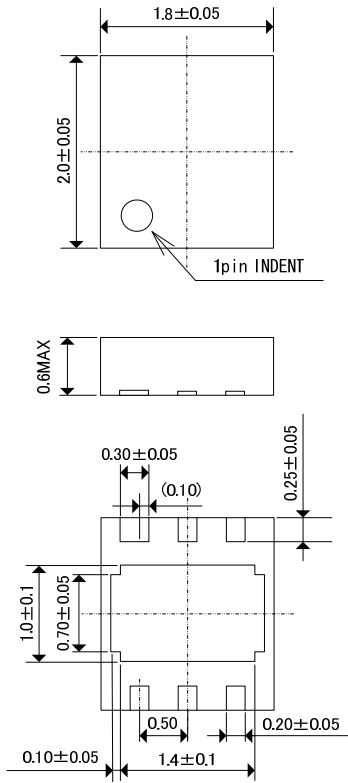

● SOT-25

(unit : mm)

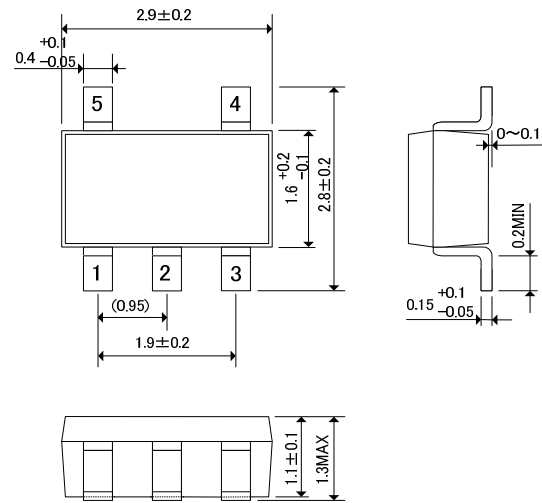

● SOT-89-5

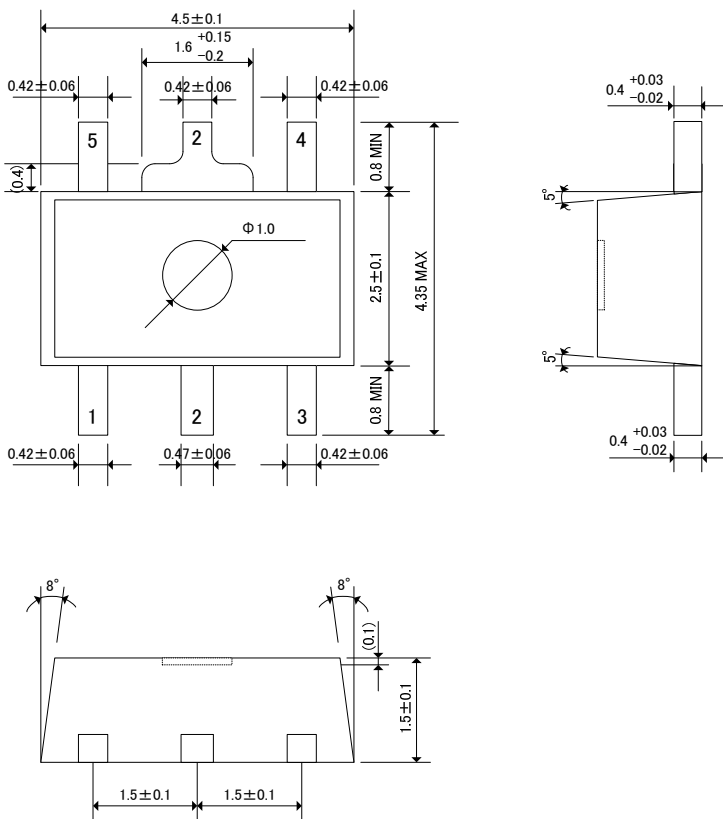

PACKAGING INFORMATION (Continued)

●USP-6C Reference Pattern Layout

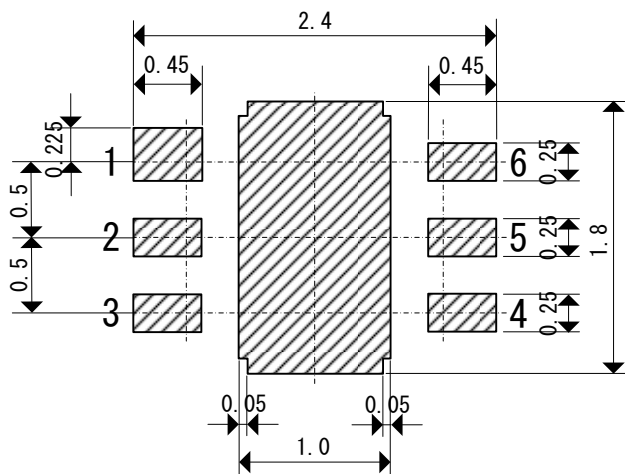

●USP-6C Reference Metal Mask Design

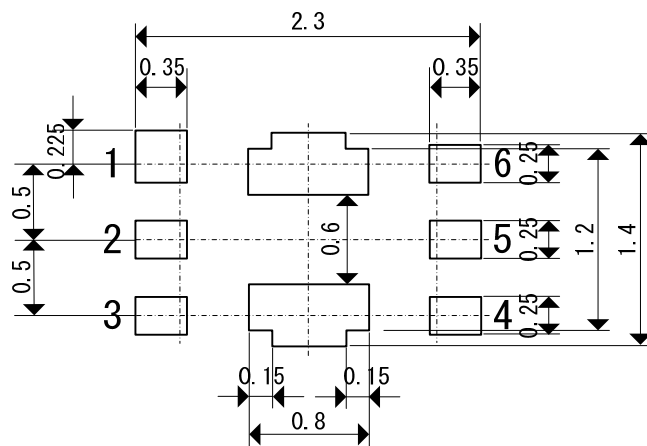

PACKAGING INFORMATION (Continued)

● SOT-25 Power Dissipation

Power dissipation data for the SOT-25 is shown in this page.

The value of power dissipation varies with the mount board conditions.

Please use this data as one of reference data taken in the described condition.

1. Measurement Condition (Reference data)

- Condition: Mount on a board
- Ambient: Natural convection
- Soldering: Lead (Pb) free
- Board: Dimensions 40 x 40 mm (1600 mm² in one side)
Copper (Cu) traces occupy 50% of the board area
In top and back faces
Package heat-sink is tied to the copper traces
(Board of SOT-26 is used.)
- Material: Glass Epoxy (FR-4)
- Thickness: 1.6 mm
- Through-hole: 4 x 0.8 Diameter

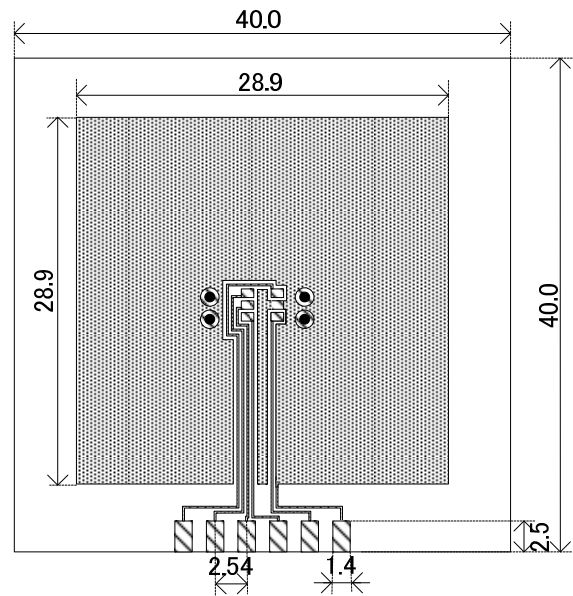

2. Power Dissipation vs. Ambient temperature

Evaluation Board (Unit: mm)

Board Mount ($T_j \text{ max} = 125^\circ\text{C}$)

Ambient Temperature ($^\circ\text{C}$)	Power Dissipation Pd (mW)	Thermal Resistance ($^\circ\text{C}/\text{W}$)
25	600	166.67
85	240	

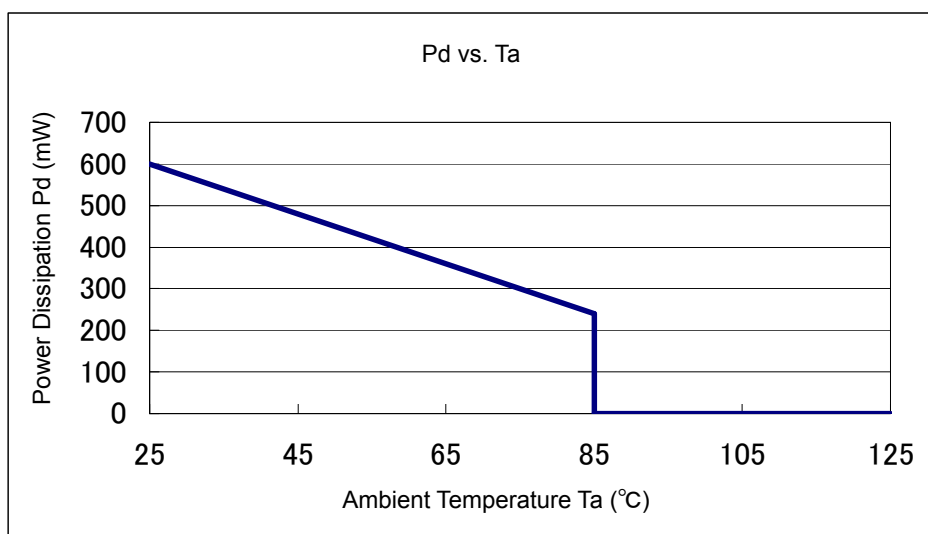

■ PACKAGING INFORMATION (Continued)

● SOT-89-5 Power Dissipation

Power dissipation data for the SOT-89-5 is shown in this page.

The value of power dissipation varies with the mount board conditions.

Please use this data as one of reference data taken in the described condition.

2. Measurement Condition (Reference data)

Condition: Mount on a board

Ambient: Natural convection

Soldering: Lead (Pb) free

Board: Dimensions 40 x 40 mm (1600 mm² in one side)

Copper (Cu) traces occupy 50% of the board area

In top and back faces

Package heat-sink is tied to the copper traces

Material: Glass Epoxy (FR-4)

Thickness: 1.6 mm

Through-hole: 5 x 0.8 Diameter

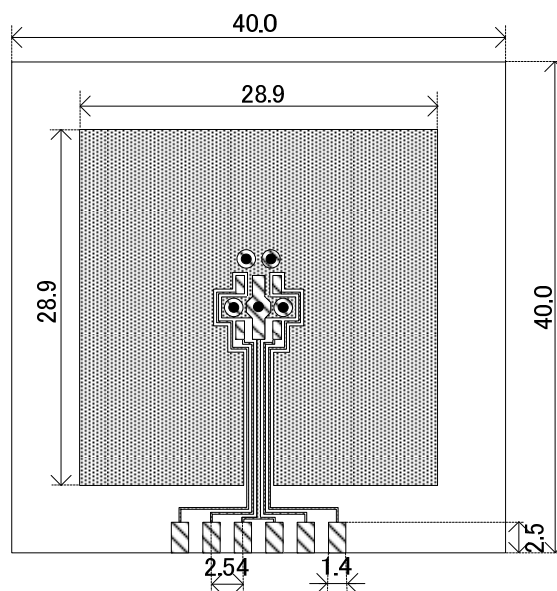

Evaluation Board (Unit: mm)

2. Power Dissipation vs. Ambient temperature

Board Mount ($T_j \text{ max} = 125^\circ\text{C}$)

Ambient Temperature (°C)	Power Dissipation Pd (mW)	Thermal Resistance (°C/W)
25	1300	76.92
85	520	

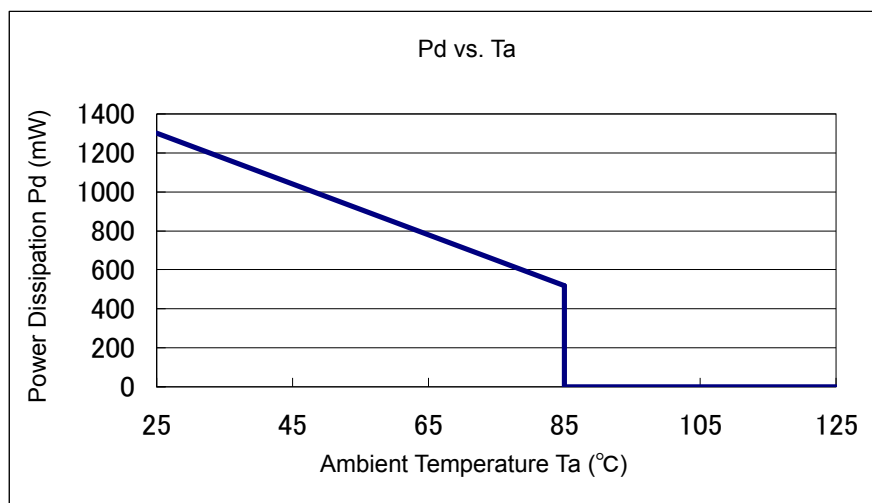

PACKAGING INFORMATION (Continued)

- USP-6C Power Dissipation

Power dissipation data for the USP-6C is shown in this page.

The value of power dissipation varies with the mount board conditions.

Please use this data as one of reference data taken in the described condition.

3. Measurement Condition (Reference data)

- Condition: Mount on a board
- Ambient: Natural convection
- Soldering: Lead (Pb) free
- Board: Dimensions 40 x 40 mm (1600 mm² in one side)
Copper (Cu) traces occupy 50% of the board area
In top and back faces
Package heat-sink is tied to the copper traces
- Material: Glass Epoxy (FR-4)
- Thickness: 1.6 mm
- Through-hole: 4 x 0.8 Diameter

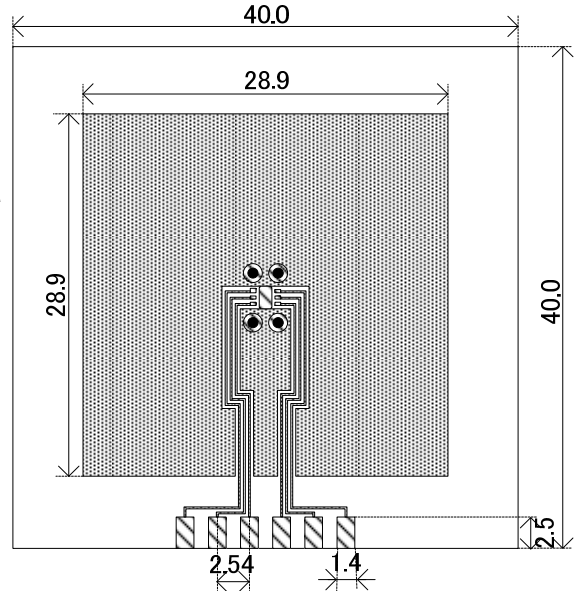

Evaluation Board (Unit: mm)

2. Power Dissipation vs. Ambient temperature

Board Mount ($T_j \text{ max} = 125^\circ\text{C}$)

Ambient Temperature ($^\circ\text{C}$)	Power Dissipation Pd (mW)	Thermal Resistance ($^\circ\text{C}/\text{W}$)
25	1000	100.00
85	400	

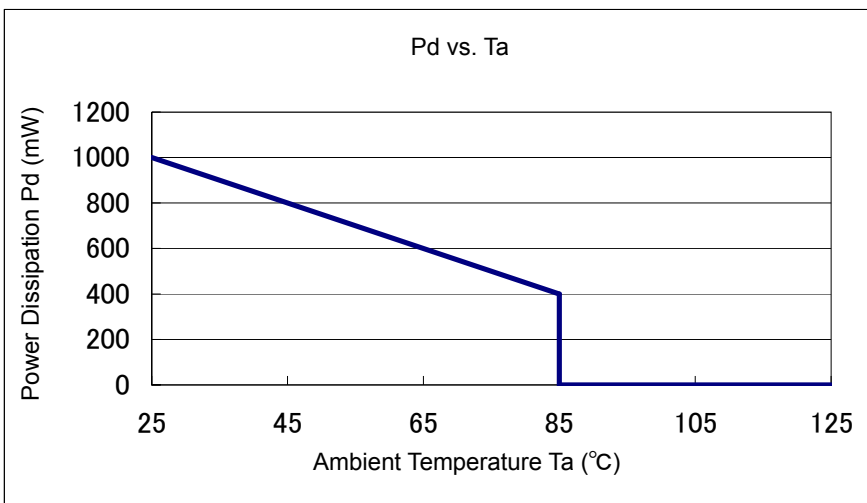

MARKING RULE

● SOT-25, SOT-89-5

SOT25

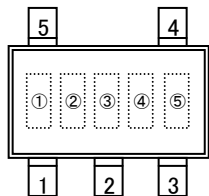

SOT89-5

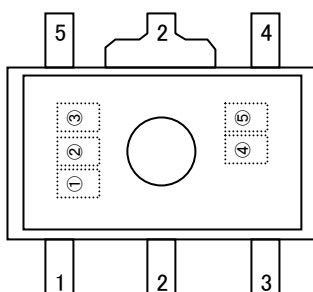

USP6C

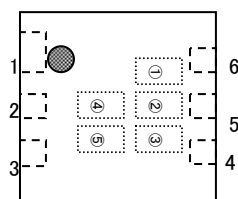

① represents product series

MARK	PRODUCT SERIES
H	XC6220*****

② represents type of CE, voltage range, and accuracy

MARK	CE	OUTPUT VOLTAGE RANGE	OUTPUT VOLTAGE ACCURACY	PRODUCT SERIES
0	A	0.8~2.9	1	XC6220A081** ~ XC6220A291**
1	A	0.8~2.9	B	XC6220A08B** ~ XC6220A29B**
2	A	3.0~5.0	1	XC6220A301** ~ XC6220A501**
3	A	3.0~4.9	B	XC6220A30B** ~ XC6220A49B**
4	B	0.8~2.9	1	XC6220B081** ~ XC6220B291**
5	B	0.8~2.9	B	XC6220B08B** ~ XC6220B29B**
6	B	3.0~5.0	1	XC6220B301** ~ XC6220B501**
7	B	3.0~4.9	B	XC6220B30B** ~ XC6220B49B**
8	C	0.8~2.9	1	XC6220C081** ~ XC6220C291**
9	C	0.8~2.9	B	XC6220C08B** ~ XC6220C29B**
A	C	3.0~5.0	1	XC6220C301** ~ XC6220C501**
B	C	3.0~4.9	B	XC6220C30B** ~ XC6220C49B**
C	D	0.8~2.9	1	XC6220D081** ~ XC6220D291**
D	D	0.8~2.9	B	XC6220D08B** ~ XC6220D29B**
E	D	3.0~5.0	1	XC6220D301** ~ XC6220D501**
F	D	3.0~4.9	B	XC6220D30B** ~ XC6220D49B**

* Accuracy "1"...0.1V increments, Accuracy "B"...0.05V increments

③ represents output voltage

MARK	OUTPUT VOLTAGE (V)		MARK	OUTPUT VOLTAGE (V)		MARK	OUTPUT VOLTAGE (V)	
0	—	3.0x	A	1.0x	4.0x	N	2.0x	5.0x
1	—	3.1x	B	1.1x	4.1x	P	2.1x	—
2	—	3.2x	C	1.2x	4.2x	R	2.2x	—
3	—	3.3x	D	1.3x	4.3x	S	2.3x	—
4	—	3.4x	E	1.4x	4.4x	T	2.4x	—
5	—	3.5x	F	1.5x	4.5x	U	2.5x	—
6	—	3.6x	H	1.6x	4.6x	V	2.6x	—
7	—	3.7x	K	1.7x	4.7x	X	2.7x	—
8	0.8x	3.8x	L	1.8x	4.8x	Y	2.8x	—
9	0.9x	3.9x	M	1.9x	4.9x	Z	2.9x	—

④,⑤ represents production lot number
01~09, 0A~0Z, 11...9Z, A1~A9, AA...Z9, ZA~ZZ repeated
(G, I, J, O, Q, W excluded)

*No character inversion used.

1. The products and product specifications contained herein are subject to change without notice to improve performance characteristics. Consult us, or our representatives before use, to confirm that the information in this datasheet is up to date.
2. We assume no responsibility for any infringement of patents, patent rights, or other rights arising from the use of any information and circuitry in this datasheet.
3. Please ensure suitable shipping controls (including fail-safe designs and aging protection) are in force for equipment employing products listed in this datasheet.
4. The products in this datasheet are not developed, designed, or approved for use with such equipment whose failure or malfunction can be reasonably expected to directly endanger the life of, or cause significant injury to, the user.
(e.g. Atomic energy; aerospace; transport; combustion and associated safety equipment thereof.)
5. Please use the products listed in this datasheet within the specified ranges.
Should you wish to use the products under conditions exceeding the specifications, please consult us or our representatives.
6. We assume no responsibility for damage or loss due to abnormal use.
7. All rights reserved. No part of this datasheet may be copied or reproduced without the prior permission of TOREX SEMICONDUCTOR LTD.

TOREX SEMICONDUCTOR LTD.

Looking for pricing, stock, or lifecycle information?

Click below to explore more details on WIN SOURCE:

- [View XC6220B331PR-G on WIN SOURCE](#)
- [Torex Semiconductor Ltd Information](#)

Optimize Your Supply Chain with WIN SOURCE Solutions

- ✓ Global Sourcing Solution
- ✓ Obsolete Management
- ✓ Cost Control Management
- ✓ Shortage Management
- ✓ Alternative Solution
- ✓ Excess Inventory Management