



**THE DATASHEET OF  
AAT3216IGV-1.2**



## General Description

The AAT3216 MicroPower low dropout (LDO) linear regulator is ideally suited for portable applications where low noise, extended battery life, and small size are critical. The AAT3216 has been specifically designed for low output noise performance, fast transient response, and high power supply rejection ratio (PSRR), making it ideal for powering sensitive RF circuits.

Other features include low quiescent current, typically 70µA, and low dropout voltage, typically less than 200mV at full output current. The device is output short-circuit protected and has a thermal shutdown circuit for additional protection under extreme conditions.

The AAT3216 also features a low-power shutdown mode for extended battery life. A Power-OK open-drain output signals when  $V_{OUT}$  is in regulation.

The AAT3216 is available in a Pb-free, space-saving 5-pin SOT23 or 8-pin SC70JW package in 12 factory-programmed voltages: 1.2V, 1.5V, 1.8V, 2.0V, 2.3V, 2.5V, 2.7V, 2.8V, 2.85V, 3.0V, 3.3V, or 3.5V.

## Features

- Low Dropout: 200mV at 150mA
- Guaranteed 150mA Output
- High Accuracy:  $\pm 1.5\%$
- 70µA Quiescent Current
- High Power Supply Ripple Rejection
- Low Self Noise
- Power-OK (POK) Output
- Fast Line and Load Transient Response
- Short-Circuit and Over-Temperature Protection
- Uses Low Equivalent Series Resistance (ESR) Ceramic Capacitors
- Shutdown Mode for Longer Battery Life
- Low Temperature Coefficient
- 12 Factory-Programmed Output Voltages
- SOT23 5-Pin or SC70JW 8-Pin Package

## Applications

- Cellular Phones
- Desktop Computers
- Digital Cameras
- Notebook Computers
- Personal Portable Electronics
- Portable Communication Devices

## Typical Application

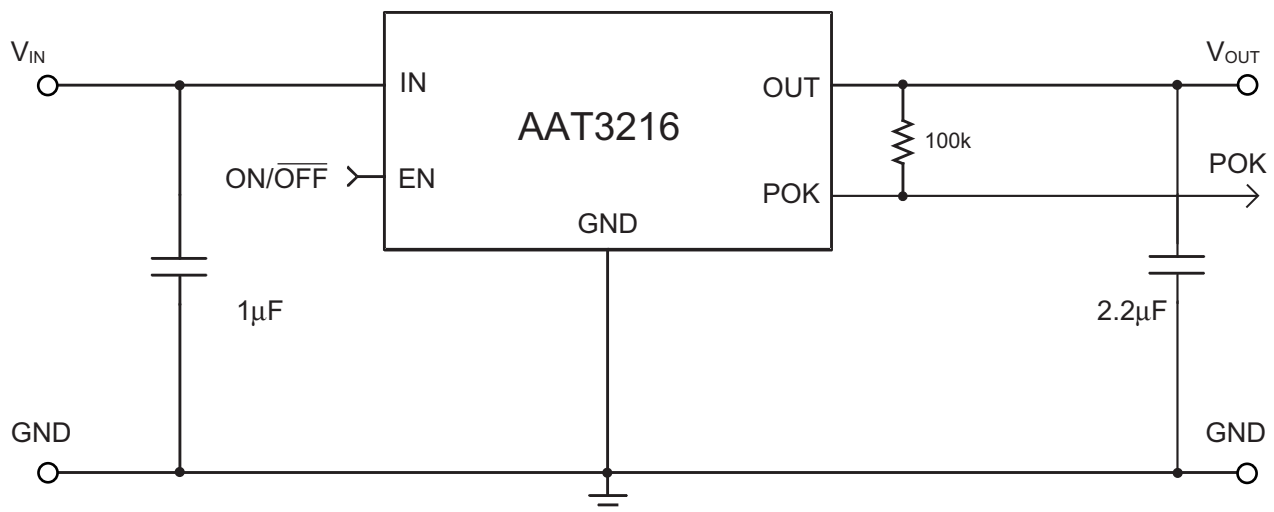

## Pin Descriptions

Pin Number		Symbol	Function
SOT23-5	SC70JW-8		
1	5, 6	IN	Input voltage pin; should be decoupled with 1 $\mu$ F or greater capacitor.
2	8	GND	Ground connection pin.
3	7	EN	Enable pin; this pin should not be left floating. When pulled low, the PMOS pass transistor turns off and all internal circuitry enters low-power mode, consuming less than 1 $\mu$ A.
4	1	POK	Power-OK output. This open-drain output is low when OUT is out of regulation. Connect a pull-up resistor from POK to OUT or IN.
5	2, 3, 4	OUT	Output pin; should be decoupled with 2.2 $\mu$ F ceramic capacitor.

## Pin Configuration

**SOT23-5  
(Top View)**

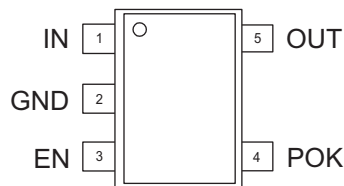

**SC70JW-8  
(Top View)**

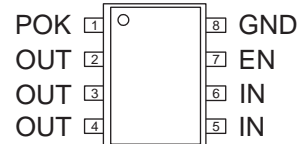

## Absolute Maximum Ratings<sup>1</sup>

$T_A = 25^\circ\text{C}$ , unless otherwise noted.

Symbol	Description	Value	Units
$V_{IN, POK}$	Input Voltage, POK	6	V
$V_{ENIN(MAX)}$	Maximum EN to Input Voltage	0.3	V
$I_{OUT}$	DC Output Current	$P_D / (V_{IN} - V_O)$	mA
$T_J$	Operating Junction Temperature Range	-40 to 150	$^\circ\text{C}$

## Thermal Information<sup>2</sup>

Symbol	Description	Rating	Units
$\Theta_{JA}$	Maximum Thermal Resistance (SOT23-5, SC70JW-8)	190	$^\circ\text{C}/\text{W}$
$P_D$	Maximum Power Dissipation (SOT23-5, SC70JW-8)	526	mW

## Recommended Operating Conditions

Symbol	Description	Rating	Units
$V_{IN}$	Input Voltage <sup>3</sup>	$(V_{OUT} + V_{DO})$ to 5.5	V
T	Ambient Temperature Range	-40 to +85	$^\circ\text{C}$

1. Stresses above those listed in Absolute Maximum Ratings may cause permanent damage to the device. Functional operation at conditions other than the operating conditions specified is not implied. Only one Absolute Maximum Rating should be applied at any one time.

2. Mounted on a demo board.

3. To calculate minimum input voltage, use the following equation:  $V_{IN(MIN)} = V_{OUT(MAX)} + V_{DO(MAX)}$  as long as  $V_{IN} \geq 2.5\text{V}$ .

## Electrical Characteristics

$V_{IN} = V_{OUT(NOM)} + 1V$  for  $V_{OUT}$  options greater than 1.5V.  $V_{IN} = 2.5$  for  $V_{OUT} \leq 1.5V$ .  $I_{OUT} = 1mA$ ,  $C_{OUT} = 2.2\mu F$ ,  $C_{IN} = 1\mu F$ ,  $T_A = -40^\circ C$  to  $+85^\circ C$ , unless otherwise noted. Typical values are at  $T_A = 25^\circ C$ .

Symbol	Description	Conditions	Min	Typ	Max	Units	
$V_{OUT}$	Output Voltage Tolerance	$I_{OUT} = 1mA$ to $150mA$	$T_A = 25^\circ C$	-1.5		1.5	%
			$T_A = -40$ to $85^\circ C$	-2.5		2.5	
$I_{OUT}$	Output Current	$V_{OUT} > 1.2V$	150			mA	
$V_{DO}$	Dropout Voltage <sup>1, 2</sup>	$I_{OUT} = 150mA$		200	300	mV	
$I_{SC}$	Short-Circuit Current	$V_{OUT} < 0.4V$		600		mA	
$I_Q$	Ground Current	$V_{IN} = 5V$ , No Load, $EN = V_{IN}$		70	125	$\mu A$	
$I_{SD}$	Shutdown Current	$V_{IN} = 5V$ , $EN = 0V$			1	$\mu A$	
$\frac{\Delta V_{OUT}}{V_{OUT} * \Delta V_{IN}}$	Line Regulation <sup>3</sup>	$V_{IN} = V_{OUT} + 1$ to $5.0V$			0.09	%/V	
$\Delta V_{OUT}(\text{line})$	Dynamic Line Regulation	$V_{IN} = V_{OUT} + 1V$ to $V_{OUT} + 2V$ , $I_{OUT} = 150mA$ , $T_R/T_F = 2\mu s$		5		mV	
$\Delta V_{OUT}(\text{load})$	Dynamic Load Regulation	$I_{OUT} = 1mA$ to $150mA$ , $T_R < 5\mu s$		30		mV	
$V_{EN(L)}$	Enable Threshold Low					0.6	
$V_{EN(H)}$	Enable Threshold High		1.5			V	
$I_{EN}$	Leakage Current on Enable Pin	$V_{EN} = 5V$			1	$\mu A$	
$V_{POK}$	POK Trip Threshold	$V_{OUT}$ Rising, $T_A = 25^\circ C$	90	94	98	% of $V_{OUT}$	
$V_{POKHYS}$	POK Hysteresis			1		% of $V_{OUT}$	
$V_{POK(OL)}$	POK Output Voltage Low	$I_{SINK} = 1mA$			0.4	V	
$I_{POK}$	POK Output Leakage Current	$V_{POK} < 5.5V$ , $V_{OUT}$ in Regulation		1	$\mu A$		
PSRR	Power Supply Rejection Ratio	$I_{OUT} = 10mA$	1kHz		65		
			10kHz		45		dB
			1MHz		42		
$T_{SD}$	Over-Temperature Shutdown Threshold			145		$^\circ C$	
$T_{HYS}$	Over-Temperature Shutdown Hysteresis			12		$^\circ C$	
$e_N$	Output Noise			250		$\mu V_{rms}$	
TC	Output Voltage Temperature Coefficient			22		ppm/ $^\circ C$	

1.  $V_{DO}$  is defined as  $V_{IN} - V_{OUT}$  when  $V_{OUT}$  is 98% of nominal.

2. For  $V_{OUT} < 2.3V$ ,  $V_{DO} = 2.5V - V_{OUT}$ .

3.  $C_{IN} = 10\mu F$ .

## Typical Characteristics

Unless otherwise noted,  $V_{IN} = 5V$ ,  $T_A = 25^\circ C$ .

**Dropout Voltage vs. Temperature**

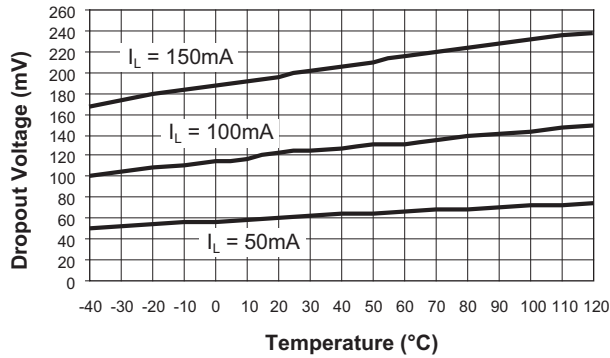

**Dropout Characteristics**

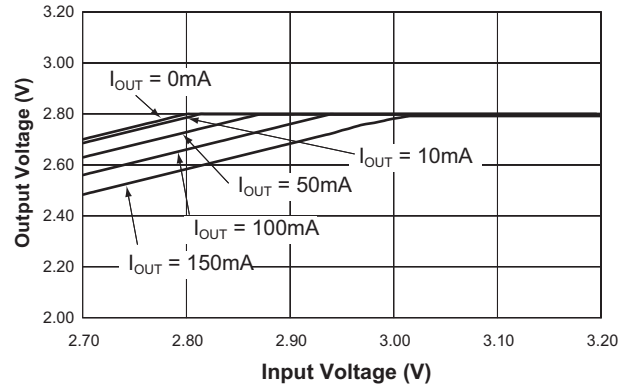

**Dropout Voltage vs. Output Current**

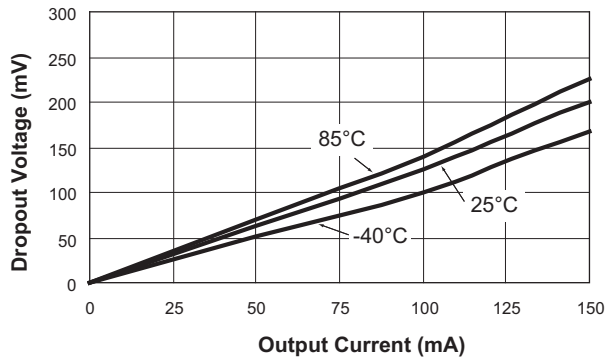

**Ground Current vs. Input Voltage**

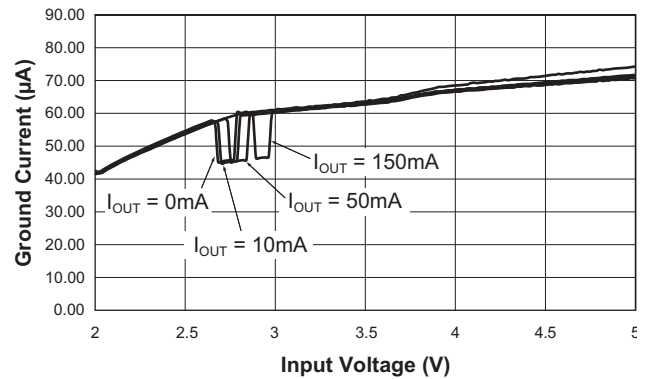

**Quiescent Current vs. Temperature**

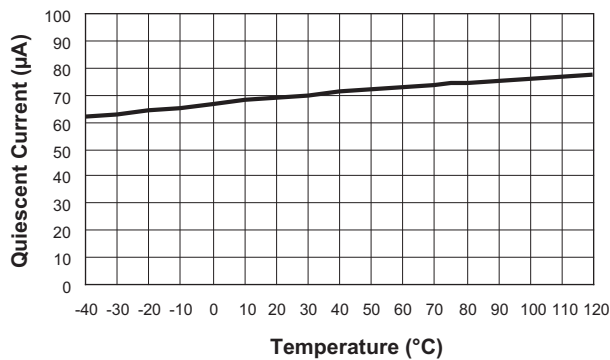

**Output Voltage vs. Temperature**

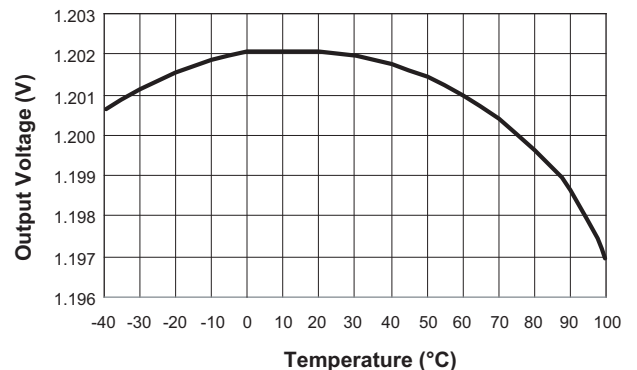

## Typical Characteristics

Unless otherwise noted,  $V_{IN} = 5V$ ,  $T_A = 25^\circ C$ .

Turn-On Time and POK Delay

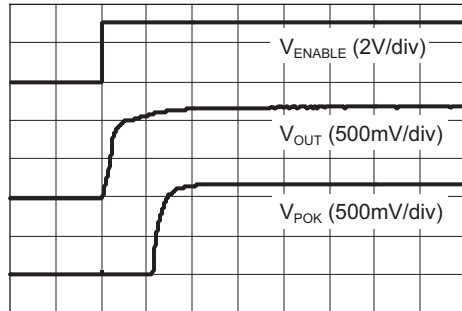

Time (10µs/div)

Turn-Off Time with POK Delay

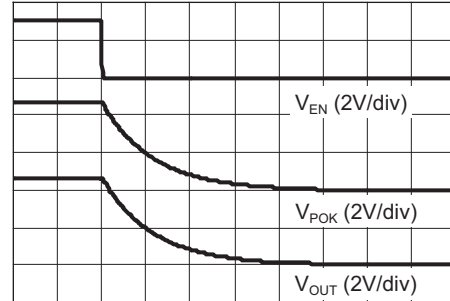

Time (200µs/div)

Line Transient Response

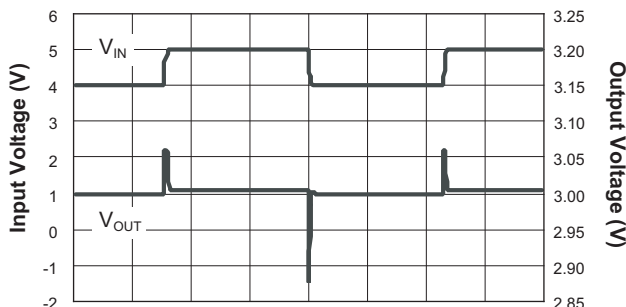

Time (100µs/div)

Load Transient Response

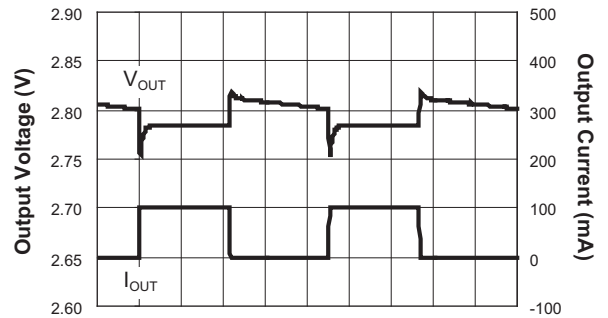

Time (100µs/div)

Over-Current Protection

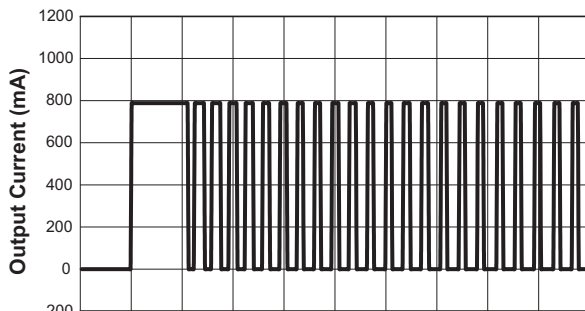

Time (20ms/div)

POK Output Response

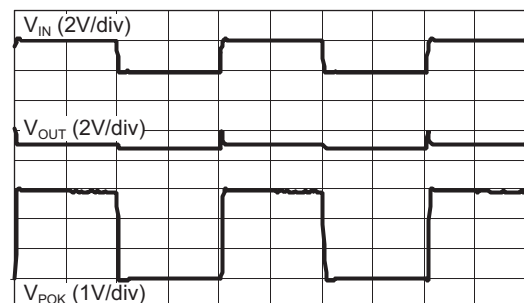

Time (200µs/div)

## Typical Characteristics

Unless otherwise noted,  $V_{IN} = 5V$ ,  $T_A = 25^\circ C$ .

**AAT3216 Self Noise**

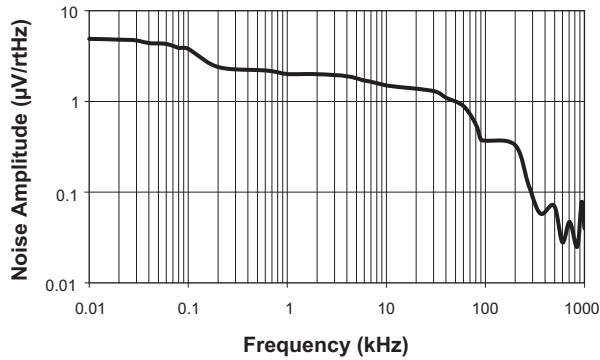

**$V_{EN(H)}$  and  $V_{EN(L)}$  vs.  $V_{IN}$**

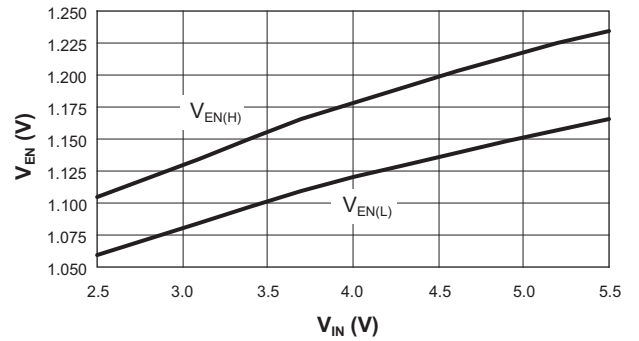

## Functional Block Diagram

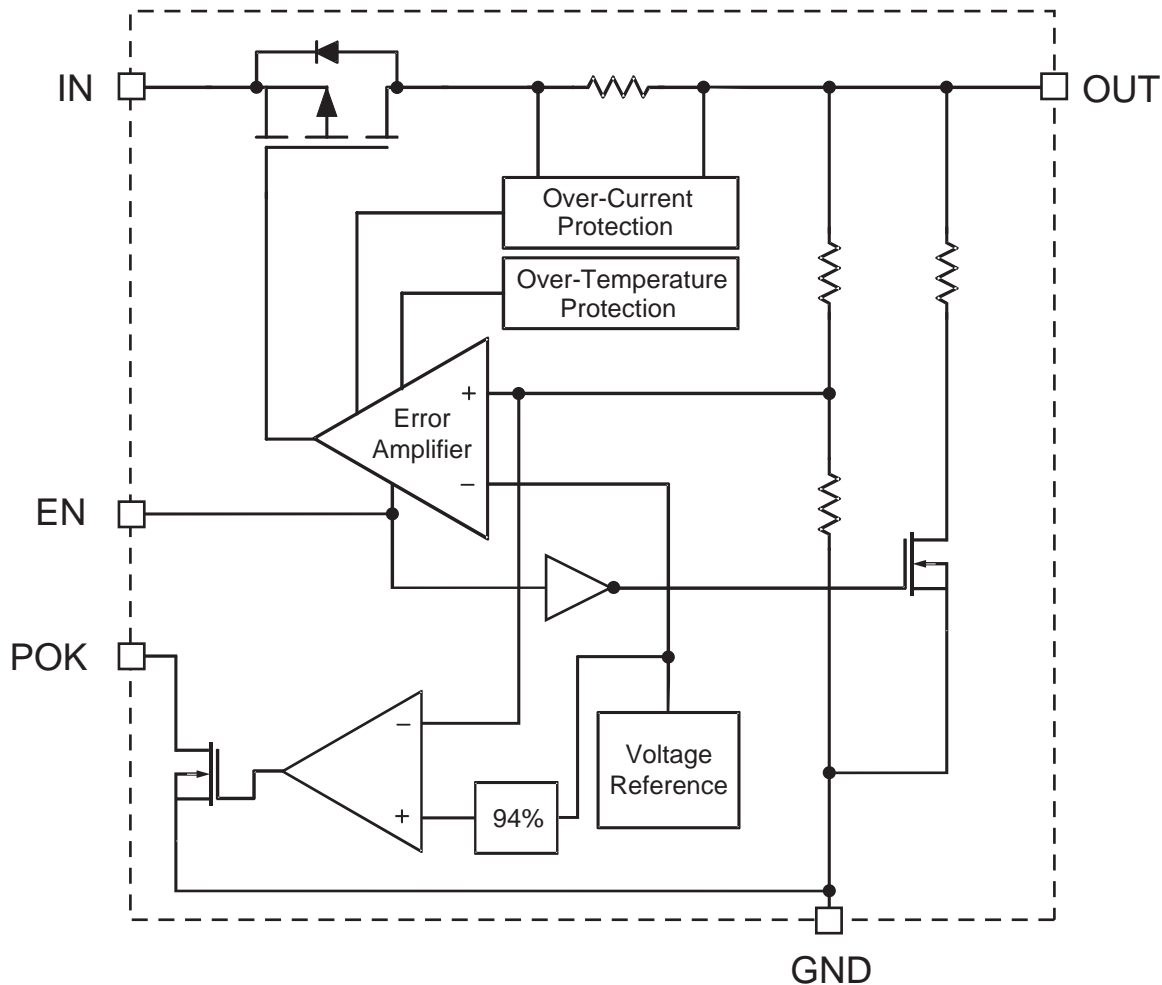

## Functional Description

The AAT3216 is intended for LDO regulator applications where output current load requirements range from no load to 150mA.

The advanced circuit design of the AAT3216 provides excellent transient response and fast turn-on ability. The LDO regulator output has been specifically optimized to function with low-cost, low-ESR ceramic capacitors. However, the design will allow for operation over a wide range of capacitor types.

The AAT3216 has an integrated Power-OK comparator which indicates when the output is out of regulation.

The device enable circuit is provided to shut down the LDO regulator for power conservation in portable products. The enable circuit has an additional output capacitor discharge circuit to assure sharp application circuit turn-off upon device shutdown.

This LDO regulator has complete short-circuit and thermal protection. The integral combination of these two internal protection circuits gives the AAT3216 a comprehensive safety system during extreme adverse operating conditions. Device power dissipation is limited to the package type and thermal dissipation properties. Refer to the Thermal Considerations section of this datasheet for details on device operation at maximum output current loads.

## Applications Information

To assure the maximum possible performance is obtained from the AAT3216, please refer to the following application recommendations.

### Input Capacitor

Typically, a 1 $\mu$ F or larger capacitor is recommended for  $C_{IN}$  in most applications. A  $C_{IN}$  capacitor is not required for basic LDO regulator operation. However, if the AAT3216 is physically located more than three centimeters from an input power source, a  $C_{IN}$  capacitor will be needed for stable operation.  $C_{IN}$  should be located as closely to the device  $V_{IN}$  pin as practically possible.  $C_{IN}$  values greater than 1 $\mu$ F will offer superior input line transient response and will assist in maximizing the highest possible power supply ripple rejection.

Ceramic, tantalum, or aluminum electrolytic capacitors may be selected for  $C_{IN}$ . There is no specific capacitor ESR requirement for  $C_{IN}$ . However, for 150mA LDO regulator output operation, ceramic capacitors are recommended for  $C_{IN}$  due to their inherent capability over tantalum capacitors to withstand input current surges from low impedance sources such as batteries in portable devices.

### Output Capacitor

For proper load voltage regulation and operational stability, a capacitor is required between pins  $V_{OUT}$  and GND. The  $C_{OUT}$  capacitor connection to the LDO regulator ground pin should be made as direct as practically possible for maximum device performance.

The AAT3216 has been specifically designed to function with very low ESR ceramic capacitors. For best performance, ceramic capacitors are recommended.

Typical output capacitor values for maximum output current conditions range from 1 $\mu$ F to 10 $\mu$ F. Applications utilizing the exceptionally low output noise and optimum power supply ripple rejection characteristics of the AAT3216 should use 2.2 $\mu$ F or greater for  $C_{OUT}$ . If desired,  $C_{OUT}$  may be increased without limit.

In low output current applications where output load is less than 10mA, the minimum value for  $C_{OUT}$  can be as low as 0.47 $\mu$ F.

## Capacitor Characteristics

Ceramic composition capacitors are highly recommended over all other types of capacitors for use with the AAT3216. Ceramic capacitors offer many advantages over their tantalum and aluminum electrolytic counterparts. A ceramic capacitor typically has very low ESR, is lower cost, has a smaller PCB footprint, and is non-polarized. Line and load transient response of the LDO regulator is improved by using low ESR ceramic capacitors. Since ceramic capacitors are non-polarized, they are not prone to incorrect connection damage.

**Equivalent Series Resistance:** ESR is a very important characteristic to consider when selecting a capacitor. ESR is the internal series resistance associated with a capacitor that includes lead resistance, internal connections, size and area, material composition, and ambient temperature. Typically, capacitor ESR is measured in milliohms for ceramic capacitors and can range to more than several ohms for tantalum or aluminum electrolytic capacitors.

**Ceramic Capacitor Materials:** Ceramic capacitors less than 0.1 $\mu$ F are typically made from NPO or C0G materials. NPO and C0G materials generally have tight tolerance and are very stable over temperature. Larger capacitor values are usually composed of X7R, X5R, Z5U, or Y5V dielectric materials. Large ceramic capacitors (i.e., greater than 2.2 $\mu$ F) are often available in low-cost Y5V and Z5U dielectrics. These two material types are not recommended for use with LDO regulators since the capacitor tolerance can vary more than  $\pm 50\%$  over the operating temperature range of the device. A 2.2 $\mu$ F Y5V capacitor could be reduced to 1 $\mu$ F over temperature; this could cause problems for circuit operation. X7R and X5R dielectrics are much more desirable. The temperature tolerance of X7R dielectric is better than  $\pm 15\%$ .

Capacitor area is another contributor to ESR. Capacitors that are physically large in size will have a lower ESR when compared to a smaller sized capacitor of an equivalent material and capacitance value. These larger devices can improve circuit transient response when compared to an equal value capacitor in a smaller package size.

Consult capacitor vendor datasheets carefully when selecting capacitors for LDO regulators.

## POK Output

The AAT3216 features an integrated Power-OK comparator which can be used as an error flag. The POK open-drain output goes low when OUT is 6% below its nominal

regulation voltage. Connect a pull-up resistor from POK to OUT or IN. A delayed POK signal can be implemented with a capacitor in parallel with the pull-up resistor.

### **Enable Function**

The AAT3216 features an LDO regulator enable/disable function. This pin (EN) is active high and is compatible with CMOS logic. To assure the LDO regulator will switch on, the EN turn-on control level must be greater than 2.0V. The LDO regulator will go into the disable shutdown mode when the voltage on the EN pin falls below 0.6V. If the enable function is not needed in a specific application, it may be tied to  $V_{IN}$  to keep the LDO regulator in a continuously on state.

When the LDO regulator is in the shutdown mode, an internal 1.5k $\Omega$  resistor is connected between  $V_{OUT}$  and GND. This is intended to discharge  $C_{OUT}$  when the LDO regulator is disabled. The internal 1.5k $\Omega$  has no adverse effect on device turn-on time.

### **Short-Circuit Protection**

The AAT3216 contains an internal short-circuit protection circuit that will trigger when the output load current exceeds the internal threshold limit. Under short-circuit conditions, the output of the LDO regulator will be current limited until the short-circuit condition is removed from the output or LDO regulator package power dissipation exceeds the device thermal limit.

### **Thermal Protection**

The AAT3216 has an internal thermal protection circuit which will turn on when the device die temperature exceeds 150°C. The internal thermal protection circuit will actively turn off the LDO regulator output pass device to prevent the possibility of over-temperature damage. The LDO regulator output will remain in a shutdown state until the internal die temperature falls back below the 150°C trip point.

The combination and interaction between the short-circuit and thermal protection systems allows the LDO regulator to withstand indefinite short-circuit conditions without sustaining permanent damage.

### **No-Load Stability**

The AAT3216 is designed to maintain output voltage regulation and stability under operational no-load condi-

tions. This is an important characteristic for applications where the output current may drop to zero.

### **Reverse Output-to-Input Voltage Conditions and Protection**

Under normal operating conditions, a parasitic diode exists between the output and input of the LDO regulator. The input voltage should always remain greater than the output load voltage, maintaining a reverse bias on the internal parasitic diode. Conditions where  $V_{OUT}$  might exceed  $V_{IN}$  should be avoided since this would forward bias the internal parasitic diode and allow excessive current flow into the  $V_{OUT}$  pin, possibly damaging the LDO regulator.

In applications where there is a possibility of  $V_{OUT}$  exceeding  $V_{IN}$  for brief amounts of time during normal operation, the use of a larger value  $C_{IN}$  capacitor is highly recommended. A larger value of  $C_{IN}$  with respect to  $C_{OUT}$  will effect a slower  $C_{IN}$  decay rate during shutdown, thus preventing  $V_{OUT}$  from exceeding  $V_{IN}$ . In applications where there is a greater danger of  $V_{OUT}$  exceeding  $V_{IN}$  for extended periods of time, it is recommended to place a Schottky diode across  $V_{IN}$  to  $V_{OUT}$  (connecting the cathode to  $V_{IN}$  and anode to  $V_{OUT}$ ). The Schottky diode forward voltage should be less than 0.45V.

### **Thermal Considerations and High Output Current Applications**

The AAT3216 is designed to deliver a continuous output load current of 150mA under normal operating conditions.

The limiting characteristic for the maximum output load current safe operating area is essentially package power dissipation and the internal preset thermal limit of the device. In order to obtain high operating currents, careful device layout and circuit operating conditions must be taken into account.

The following discussions will assume the LDO regulator is mounted on a printed circuit board utilizing the minimum recommended footprint as stated in the Layout Considerations section of this document.

At any given ambient temperature ( $T_A$ ), the maximum package power dissipation can be determined by the following equation:

$$P_{D(MAX)} = \frac{T_{J(MAX)} - T_A}{\theta_{JA}}$$

Constants for the AAT3216 are  $T_{J(MAX)}$ , the maximum junction temperature for the device which is 125°C, and  $\Theta_{JA} = 190^\circ\text{C/W}$ , the package thermal resistance. Typically, maximum conditions are calculated at the maximum operating temperature where  $T_A = 85^\circ\text{C}$ , under normal ambient conditions  $T_A = 25^\circ\text{C}$ . Given  $T_A = 85^\circ\text{C}$ , the maximum package power dissipation is 211mW. At  $T_A = 25^\circ\text{C}$ , the maximum package power dissipation is 526mW.

The maximum continuous output current for the AAT3216 is a function of the package power dissipation and the input-to-output voltage drop across the LDO regulator. Refer to the following simple equation:

$$I_{OUT(MAX)} < \frac{P_{D(MAX)}}{V_{IN} - V_{OUT}}$$

For example, if  $V_{IN} = 5\text{V}$ ,  $V_{OUT} = 3\text{V}$ , and  $T_A = 25^\circ\text{C}$ ,  $I_{OUT(MAX)} < 264\text{mA}$ . If the output load current were to exceed 264mA or if the ambient temperature were to increase, the internal die temperature would increase. If the condition remained constant, the LDO regulator thermal protection circuit would activate.

To determine the maximum input voltage for a given load current, refer to the following equation. This calculation accounts for the total power dissipation of the LDO regulator, including that caused by ground current.

$$P_{D(MAX)} = (V_{IN} - V_{OUT})I_{OUT} + (V_{IN} \times I_{GND})$$

This formula can be solved for  $V_{IN}$  to determine the maximum input voltage.

$$V_{IN(MAX)} = \frac{P_{D(MAX)} + (V_{OUT} \times I_{OUT})}{I_{OUT} + I_{GND}}$$

The following is an example for an AAT3216 set for a 2.5V output:

$$\begin{aligned} V_{OUT} &= 2.5\text{V} \\ I_{OUT} &= 150\text{mA} \\ I_{GND} &= 150\mu\text{A} \\ V_{IN(MAX)} &= \frac{526\text{mW} + (2.5\text{V} \times 150\text{mA})}{150\text{mA} + 150\mu\text{A}} \\ V_{IN(MAX)} &= 6.00\text{V} \end{aligned}$$

From the discussion above,  $P_{D(MAX)}$  was determined to equal 526mW at  $T_A = 25^\circ\text{C}$ .

Thus, the AAT3216 can sustain a constant 2.5V output at a 150mA load current as long as  $V_{IN}$  is  $\leq 6.00\text{V}$  at an ambient temperature of 25°C. 6.0V is the absolute maximum voltage where an AAT3216 would never be operated, thus at 25°C, the device would not have any thermal concerns or operational  $V_{IN(MAX)}$  limits.

This situation can be different at 85°C. The following is an example for an AAT3216 set for a 2.5V output at 85°C:

$$\begin{aligned} V_{OUT} &= 2.5\text{V} \\ I_{OUT} &= 150\text{mA} \\ I_{GND} &= 150\mu\text{A} \\ V_{IN(MAX)} &= \frac{211\text{mW} + (2.5\text{V} \times 150\text{mA})}{150\text{mA} + 150\mu\text{A}} \\ V_{IN(MAX)} &= 3.90\text{V} \end{aligned}$$

From the discussion above,  $P_{D(MAX)}$  was determined to equal 211mW at  $T_A = 85^\circ\text{C}$ .

Higher input-to-output voltage differentials can be obtained with the AAT3216, while maintaining device functions within the thermal safe operating area. To accomplish this, the device thermal resistance must be reduced by increasing the heat sink area or by operating the LDO regulator in a duty-cycled mode.

For example, an application requires  $V_{IN} = 4.2\text{V}$  while  $V_{OUT} = 2.5\text{V}$  at a 150mA load and  $T_A = 85^\circ\text{C}$ .  $V_{IN}$  is greater than 3.90V, which is the maximum safe continuous input level for  $V_{OUT} = 2.5\text{V}$  at 150mA for  $T_A = 85^\circ\text{C}$ . To maintain this high input voltage and output current level, the LDO regulator must be operated in a duty-cycled mode. Refer to the following calculation for duty-cycle operation:

$$\begin{aligned} I_{GND} &= 150\mu\text{A} \\ I_{OUT} &= 150\text{mA} \\ V_{IN} &= 4.2\text{V} \\ V_{OUT} &= 2.5\text{V} \\ \%DC &= 100 \frac{P_{D(MAX)}}{(V_{IN} - V_{OUT})I_{OUT} + (V_{IN} \times I_{GND})} \\ \%DC &= 100 \frac{211\text{mW}}{(4.2\text{V} - 2.5\text{V})150\text{mA} + (4.2\text{V} \times 150\mu\text{A})} \\ \%DC &= 85.54\% \end{aligned}$$

$P_{D(MAX)}$  was assumed to be 211mW.

For a 150mA output current and a 2.7V drop across the AAT3216 at an ambient temperature of 85°C, the maximum on-time duty cycle for the device would be 85.54%.

The following family of curves show the safe operating area for duty-cycled operation from ambient room temperature to the maximum operating level.

**Device Duty Cycle vs.  $V_{DROP}$**   
( $V_{OUT} = 2.5V @ 25°C$ )

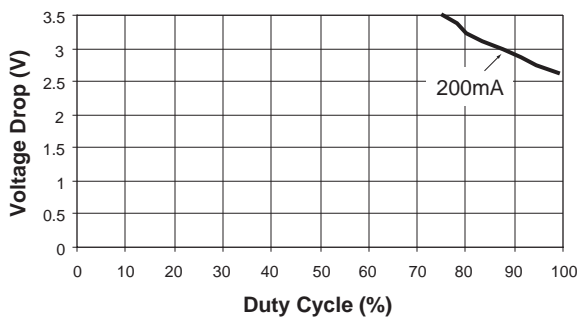

**Device Duty Cycle vs.  $V_{DROP}$**   
( $V_{OUT} = 2.5V @ 50°C$ )

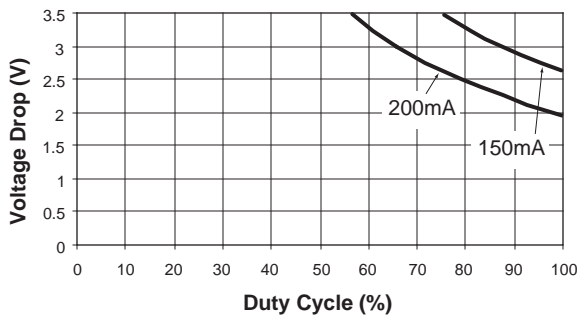

**Device Duty Cycle vs.  $V_{DROP}$**   
( $V_{OUT} = 2.5V @ 85°C$ )

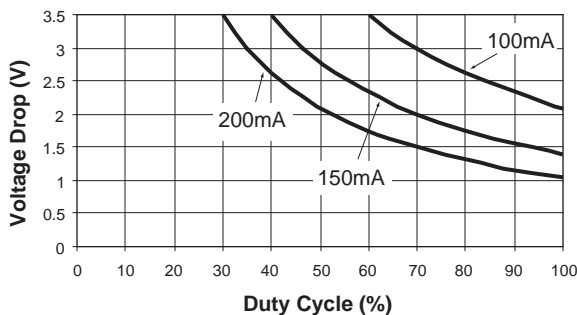

### High Peak Output Current Applications

Some applications require the LDO regulator to operate at continuous nominal level with short duration, high-current peaks. The duty cycles for both output current levels must be taken into account. To do so, one would first need to calculate the power dissipation at the nominal continuous level, then factor in the additional power dissipation due to the short duration, high-current peaks.

For example, a 2.5V system using a AAT3216IGV-2.5-T1 operates at a continuous 100mA load current level and has short 150mA current peaks. The current peak occurs for 378µs out of a 4.61ms period. It will be assumed the input voltage is 4.2V.

First, the current duty cycle in percent must be calculated:

$$\begin{aligned} \% \text{ Peak Duty Cycle} &= X/100 = 378\mu\text{s}/4.61\text{ms} \\ \% \text{ Peak Duty Cycle} &= 8.2\% \end{aligned}$$

The LDO regulator will be under the 100mA load for 91.8% of the 4.61ms period and have 150mA peaks occurring for 8.2% of the time. Next, the continuous nominal power dissipation for the 100mA load should be determined then multiplied by the duty cycle to conclude the actual power dissipation over time.

$$\begin{aligned} P_{D(MAX)} &= (V_{IN} - V_{OUT})I_{OUT} + (V_{IN} \times I_{GND}) \\ P_{D(100mA)} &= (4.2V - 2.5V)100mA + (4.2V \times 150\mu A) \\ P_{D(100mA)} &= 170.6mW \end{aligned}$$

$$\begin{aligned} P_{D(91.8\%D/C)} &= \%DC \times P_{D(100mA)} \\ P_{D(91.8\%D/C)} &= 0.918 \times 170.6mW \\ P_{D(91.8\%D/C)} &= 156.6mW \end{aligned}$$

The power dissipation for 100mA load occurring for 91.8% of the duty cycle will be 156.6mW. Now the power dissipation for the remaining 8.2% of the duty cycle at the 150mA load can be calculated:

$$\begin{aligned} P_{D(MAX)} &= (V_{IN} - V_{OUT})I_{OUT} + (V_{IN} \times I_{GND}) \\ P_{D(150mA)} &= (4.2V - 2.5V)150mA + (4.2V \times 150\mu A) \\ P_{D(150mA)} &= 255.6mW \end{aligned}$$

$$\begin{aligned} P_{D(8.2\%D/C)} &= \%DC \times P_{D(150mA)} \\ P_{D(8.2\%D/C)} &= 0.082 \times 255.6mW \\ P_{D(8.2\%D/C)} &= 21mW \end{aligned}$$

**PowerLinear™****150mA MicroPower™ LDO with PowerOK**

The power dissipation for 150mA load occurring for 8.2% of the duty cycle will be 21mW. Finally, the two power dissipation levels can be summed to determine the total true power dissipation under the varied load.

$$\begin{aligned}P_{D(\text{total})} &= P_{D(100\text{mA})} + P_{D(150\text{mA})} \\P_{D(\text{total})} &= 156.6\text{mW} + 21\text{mW} \\P_{D(\text{total})} &= 177.6\text{mW}\end{aligned}$$

The maximum power dissipation for the AAT3216 operating at an ambient temperature of 85°C is 211mW. The device in this example will have a total power dissipation of 177.6mW. This is well within the thermal limits for safe operation of the device.

## Ordering Information

Output Voltage	Package	Marking <sup>1</sup>	Part Number (Tape and Reel) <sup>2</sup>
1.2V	SOT23-5	EAXYY	<b>AAT3216IGV-1.2-T1</b>
1.5V	SOT23-5	KJXYY	<b>AAT3216IGV-1.5-T1</b>
1.8V	SOT23-5		AAT3216IGV-1.8-T1
2.0V	SOT23-5		AAT3216IGV-2.0-T1
2.3V	SOT23-5		AAT3216IGV-2.3-T1
2.5V	SOT23-5	KKXYY	<b>AAT3216IGV-2.5-T1</b>
2.7V	SOT23-5		AAT3216IGV-2.7-T1
2.8V	SOT23-5	ELXYY	<b>AAT3216IGV-2.8-T1</b>
2.85V	SOT23-5		AAT3216IGV-2.85-T1
3.0V	SOT23-5		AAT3216IGV-3.0-T1
3.3V	SOT23-5	HQXYY	<b>AAT3216IGV-3.3-T1</b>
3.5V	SOT23-5	IYXYY	<b>AAT3216IGV-3.5-T1</b>
1.2V	SC70JW-8		AAT3216IJS-1.2-T1
1.5V	SC70JW-8		AAT3216IJS-1.5-T1
1.8V	SC70JW-8		AAT3216IJS-1.8-T1
2.0V	SC70JW-8		AAT3216IJS-2.0-T1
2.3V	SC70JW-8		AAT3216IJS-2.3-T1
2.5V	SC70JW-8		AAT3216IJS-2.5-T1
2.7V	SC70JW-8		AAT3216IJS-2.7-T1
2.8V	SC70JW-8		AAT3216IJS-2.8-T1
2.85V	SC70JW-8		AAT3216IJS-2.85-T1
3.0V	SC70JW-8	KGXYY	<b>AAT3216IJS-3.0-T1</b>
3.3V	SC70JW-8	HQXYY	<b>AAT3216IJS-3.3-T1</b>
3.5V	SC70JW-8		AAT3216IJS-3.5-T1



All AnalogicTech products are offered in Pb-free packaging. The term “Pb-free” means semiconductor products that are in compliance with current RoHS standards, including the requirement that lead not exceed 0.1% by weight in homogeneous materials. For more information, please visit our website at <http://www.analogictech.com/aboutus/quality.php>.

1. XYY = assembly and date code.

2. Sample stock is generally held on part numbers listed in **BOLD**.

## Package Information

### SOT23-5

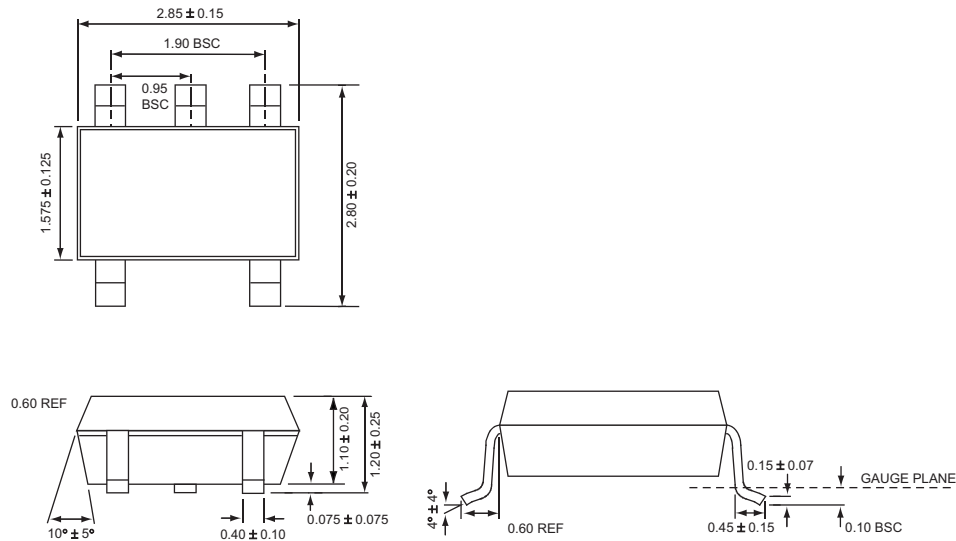

### SC70JW-8

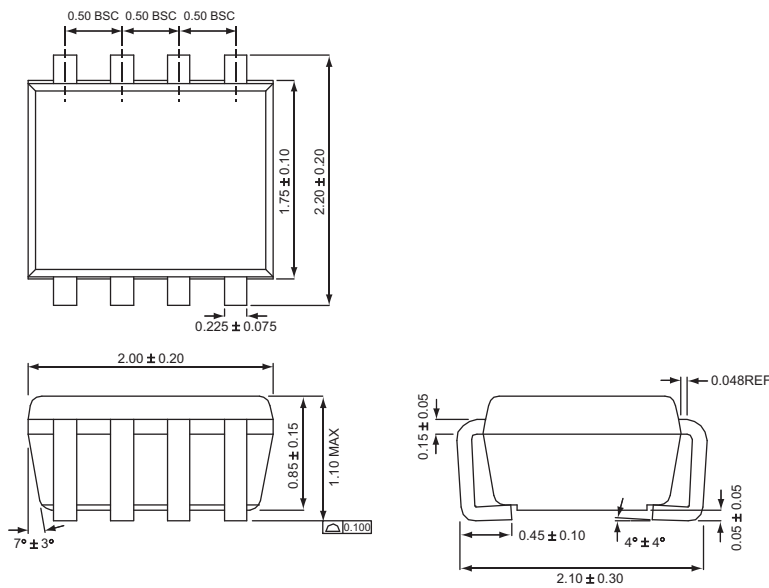

All dimensions in millimeters



PowerLinear™

**150mA MicroPower™ LDO with PowerOK**



**Advanced Analogic Technologies, Inc.**  
3230 Scott Boulevard, Santa Clara, CA 95054  
Phone (408) 737-4600  
Fax (408) 737-4611



© Advanced Analogic Technologies, Inc.  
AnalogicTech cannot assume responsibility for use of any circuitry other than circuitry entirely embodied in an AnalogicTech product. No circuit patent licenses, copyrights, mask work rights, or other intellectual property rights are implied. AnalogicTech reserves the right to make changes to their products or specifications or to discontinue any product or service without notice. Except as provided in AnalogicTech's terms and conditions of sale, AnalogicTech assumes no liability whatsoever, and AnalogicTech disclaims any express or implied warranty relating to the sale and/or use of AnalogicTech products including liability or warranties relating to fitness for a particular purpose, merchantability, or infringement of any patent, copyright or other intellectual property right. In order to minimize risks associated with the customer's applications, adequate design and operating safeguards must be provided by the customer to minimize inherent or procedural hazards. Testing and other quality control techniques are utilized to the extent AnalogicTech deems necessary to support this warranty. Specific testing of all parameters of each device is not necessarily performed. AnalogicTech and the AnalogicTech logo are trademarks of Advanced Analogic Technologies Incorporated. All other brand and product names appearing in this document are registered trademarks or trademarks of their respective holders.

## Looking for pricing, stock, or lifecycle information?

Click below to explore more details on WIN SOURCE:

-  [View AAT3216IGV-1.2 on WIN SOURCE](#)
-  [Skyworks Solutions Inc. Information](#)

## Optimize Your Supply Chain with WIN SOURCE Solutions

-  Global Sourcing Solution
-  Obsolete Management
-  Cost Control Management
-  Shortage Management
-  Alternative Solution
-  Excess Inventory Management