



**THE DATASHEET OF
AAT3218IGV-2.8-T1**



General Description

The AAT3218 MicroPower low dropout linear regulator is ideally suited for portable applications where very fast transient response, extended battery life, and small size are critical. The AAT3218 has been specifically designed for high-speed turn-on and turn-off performance, fast transient response, and good power supply ripple rejection (PSRR), and is reasonably low noise, making it ideal for powering sensitive circuits with fast switching requirements.

Other features include low quiescent current, typically 70µA, and low dropout voltage, typically less than 200mV at the maximum output current level of 150mA. The device is output short-circuit protected and has a thermal shutdown circuit for additional protection under extreme operating conditions.

The AAT3218 also features a low-power shutdown mode for extended battery life. A reference bypass pin has been provided to improve PSRR performance and output noise, by connecting a small external capacitor from device reference output to ground.

The AAT3218 is available in a Pb-free, space-saving 5-pin SOT23 or 8-pin SC70JW package in 5 factory-programmed voltages: 1.2V, 2.3V, 2.8V, 2.85V, or 3.5V.

Features

- Low Dropout: 200mV at 150mA
- Guaranteed 150mA Output
- High Accuracy: ±1.5%
- 70µA Quiescent Current
- Fast Line and Load Transient Response
- High-Speed Device Turn-On and Shutdown
- High Power Supply Ripple Rejection
- Low Self Noise
- Short-Circuit and Over-Temperature Protection
- Uses Low Equivalent Series Resistance (ESR) Ceramic Capacitors
- Output Noise Reduction Bypass Capacitor
- Shutdown Mode for Longer Battery Life
- Low Temperature Coefficient
- 5 Factory-Programmed Output Voltages
- SOT23 5-Pin or SC70JW 8-Pin Package

Applications

- Bluetooth™ Headsets
- Cellular Phones
- Digital Cameras
- Notebook Computers
- Personal Portable Electronics
- Portable Communication Devices

Typical Application

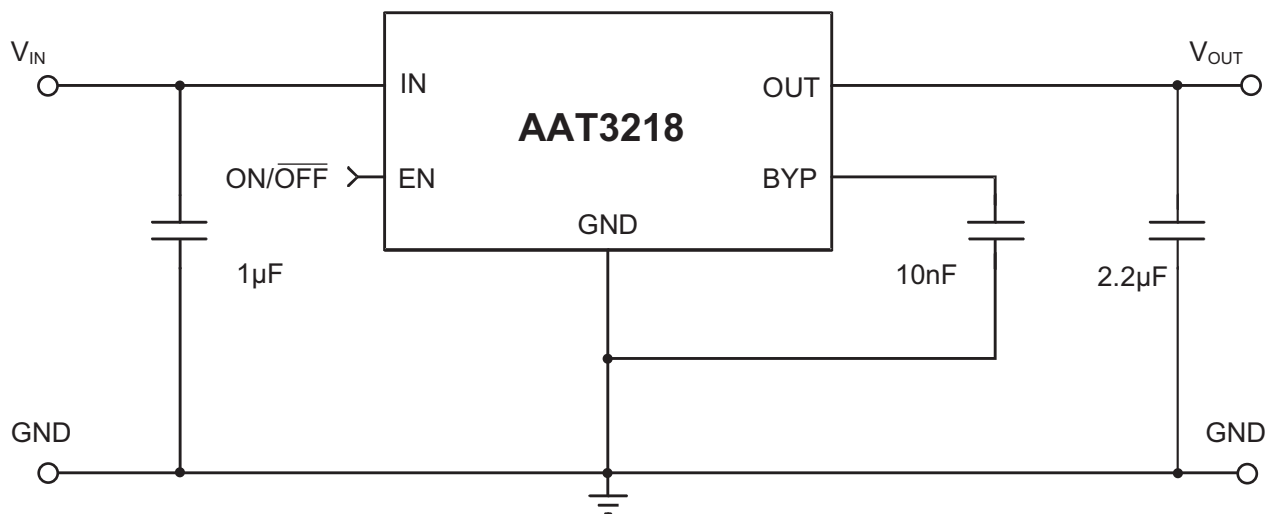

Pin Descriptions

Pin Number		Symbol	Function
SOT23-5	SC70JW-8		
1	5, 6	IN	Input voltage pin; should be decoupled with 1 μ F or greater capacitor.
2	8	GND	Ground connection pin.
3	7	EN	Enable pin; this pin should not be left floating. When pulled low, the PMOS pass transistor turns off and all internal circuitry enters low-power mode, consuming less than 1 μ A.
4	1	BYP	Bypass capacitor connection; to improve AC ripple rejection, connect a 10nF capacitor to GND. This will also provide a soft-start function.
5	2, 3, 4	OUT	Output pin; should be decoupled with 2.2 μ F ceramic capacitor.

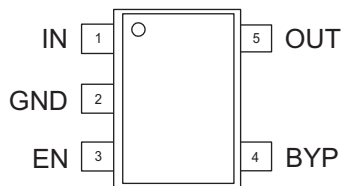
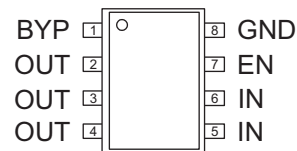
Pin Configuration**SOT23-5
(Top View)****SC70JW-8
(Top View)**

150mA MicroPower™ High Performance LDO**Absolute Maximum Ratings¹**

$T_A = 25^\circ\text{C}$, unless otherwise noted.

Symbol	Description	Value	Units
V_{IN}	Input Voltage	6	V
$V_{ENIN(MAX)}$	Maximum EN to Input Voltage	0.3	
I_{OUT}	DC Output Current	$P_D/(V_{IN}-V_O)$	mA
T_J	Operating Junction Temperature Range	-40 to 150	$^\circ\text{C}$

Thermal Information²

Symbol	Description	Rating	Units
Θ_{JA}	Maximum Thermal Resistance (SOT23-5, SC70JW-8)	190	$^\circ\text{C}/\text{W}$
P_D	Maximum Power Dissipation (SOT23-5, SC70JW-8)	526	mW

Recommended Operating Conditions

Symbol	Description	Rating	Units
V_{IN}	Input Voltage ³	$(V_{OUT}+V_{DO})$ to 5.5	V
T	Ambient Temperature Range	-40 to +85	$^\circ\text{C}$

1. Stresses above those listed in Absolute Maximum Ratings may cause permanent damage to the device. Functional operation at conditions other than the operating conditions specified is not implied.

2. Mounted on a demo board.

3. To calculate minimum input voltage, use the following equation: $V_{IN(MIN)} = V_{OUT(MAX)} + V_{DO(MAX)}$ as long as $V_{IN} \geq 2.5\text{V}$.

150mA MicroPower™ High Performance LDO

Electrical Characteristics

$V_{IN} = V_{OUT(NOM)} + 1V$ for V_{OUT} options greater than 1.5V. $V_{IN} = 2.5$ for $V_{OUT} \leq 1.5V$. $I_{OUT} = 1mA$, $C_{OUT} = 2.2\mu F$, $C_{IN} = 1\mu F$, $T_A = -40^\circ C$ to $+85^\circ C$, unless otherwise noted. Typical values are $T_A = 25^\circ C$.

Symbol	Description	Conditions	Min	Typ	Max	Units	
V_{OUT}	Output Voltage Tolerance	$I_{OUT} = 1mA$ to $150mA$	$T_A = 25^\circ C$	-1.5		1.5	%
			$T_A = -40^\circ C$ to $85^\circ C$	-2.5		2.5	
I_{OUT}	Output Current	$V_{OUT} > 1.2V$	150			mA	
V_{DO}	Dropout Voltage ^{1, 2}	$I_{OUT} = 150mA$		200	300	mV	
I_{SC}	Short-Circuit Current	$V_{OUT} < 0.4V$		600		mA	
I_Q	Ground Current	$V_{IN} = 5V$, No Load, $EN = V_{IN}$		70	125	μA	
I_{SD}	Shutdown Current	$V_{IN} = 5V$, $EN = 0V$			1		
$\frac{\Delta V_{OUT}}{V_{OUT}} \cdot \Delta V_{IN}$	Line Regulation	$V_{IN} = V_{OUT} + 1$ to $5.0V$			0.09	%/V	
$\Delta V_{OUT}(\text{line})$	Dynamic Line Regulation	$V_{IN} = V_{OUT} + 1V$ to $V_{OUT} + 2V$, $I_{OUT} = 150mA$, $T_R/T_F = 2\mu s$		2.5		mV	
$\Delta V_{OUT}(\text{load})$	Dynamic Load Regulation	$I_{OUT} = 1mA$ to $150mA$, $T_R < 5\mu s$		30			
t_{ENDLY}	Enable Delay Time	$BYP = \text{Open}$		15		μs	
$V_{EN(L)}$	Enable Threshold Low				0.6	V	
$V_{EN(H)}$	Enable Threshold High		1.5				
I_{EN}	Leakage Current on Enable Pin	$V_{EN} = 5V$			1	μA	
PSRR	Power Supply Rejection Ratio	$I_{OUT} = 10mA$, $C_{BYP} = 10nF$	1 kHz		67	dB	
			10kHz		47		
			1MHz		45		
T_{SD}	Over-Temperature Shutdown Threshold			145		$^\circ C$	
T_{HYS}	Over-Temperature Shutdown Hysteresis			12			
e_N	Output Noise	Noise Power BW = 300Hz - 50kHz		50		μV_{rms}	
TC	Output Voltage Temperature Coefficient			22		ppm/ $^\circ C$	

1. V_{DO} is defined as $V_{IN} - V_{OUT}$ when V_{OUT} is 98% of nominal.

2. For $V_{OUT} < 2.3V$, $V_{DO} = 2.5V - V_{OUT}$.

Typical Characteristics

Unless otherwise noted, $V_{IN} = 5V$, $T_A = 25^\circ C$.

Dropout Voltage vs. Temperature

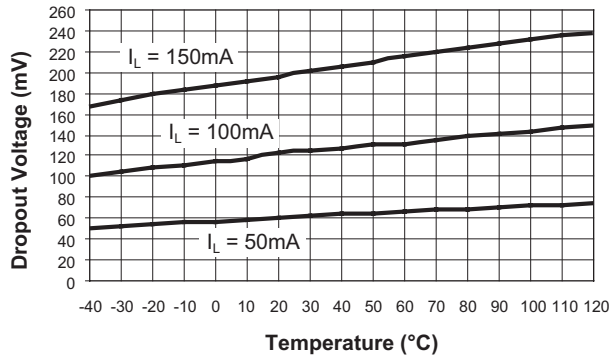

Dropout Characteristics

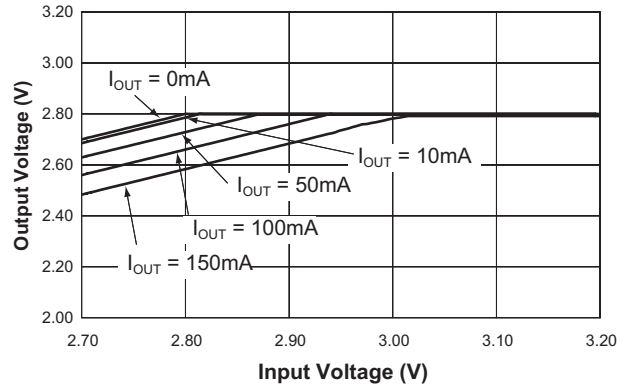

Dropout Voltage vs. Output Current

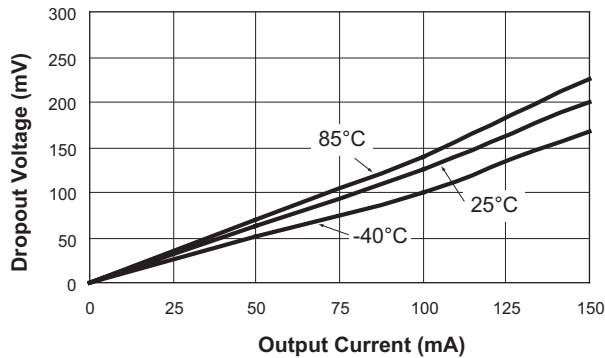

Ground Current vs. Input Voltage

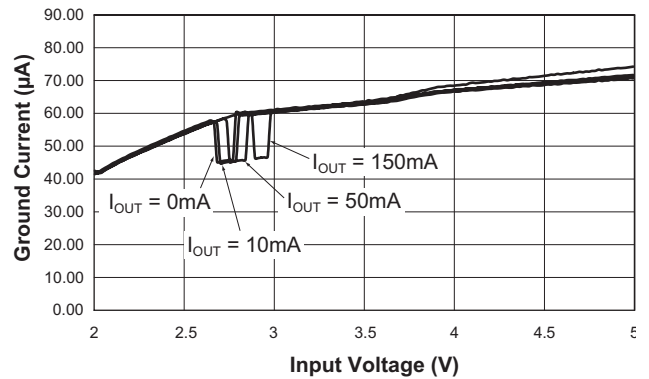

Quiescent Current vs. Temperature

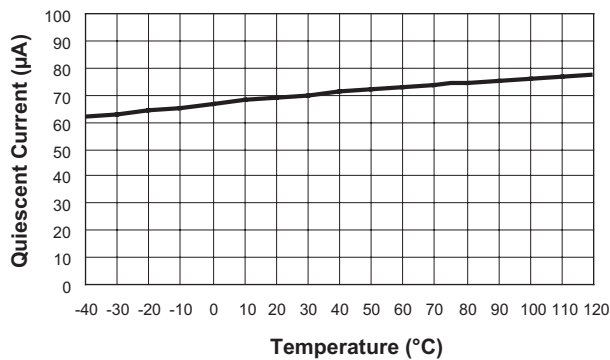

Output Voltage vs. Temperature

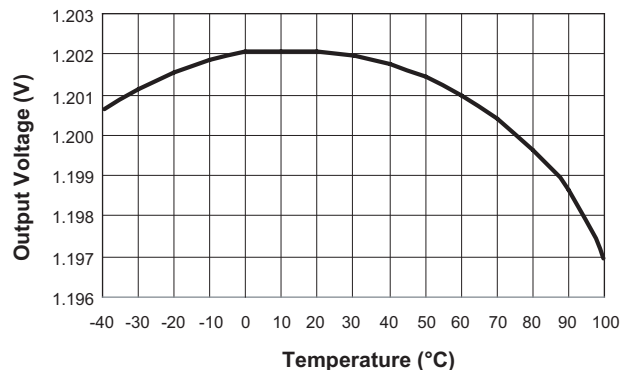

AAT3218

150mA MicroPower™ High Performance LDO

Typical Characteristics

Unless otherwise noted, $V_{IN} = 5V$, $T_A = 25^\circ C$.

Over-Current Protection

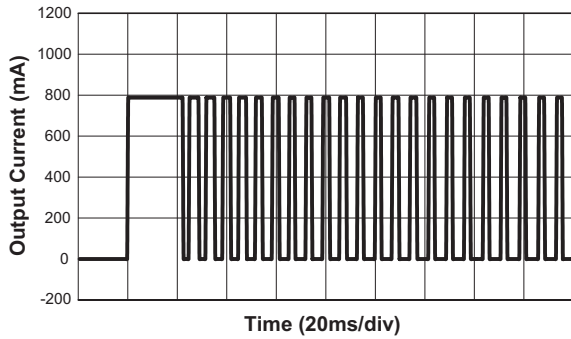

Load Transient Response

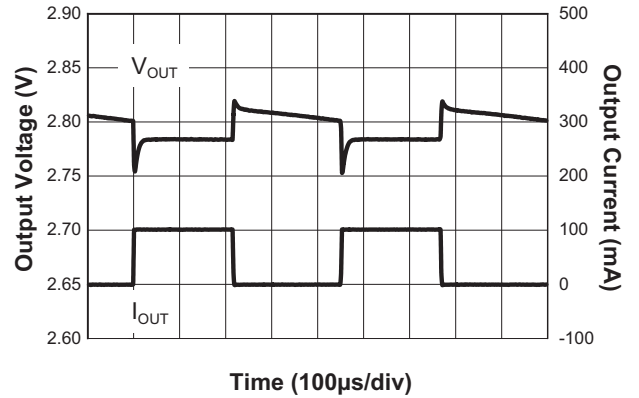

AAT3218 Self Noise
($C_{OUT} = 10\mu F$, ceramic)

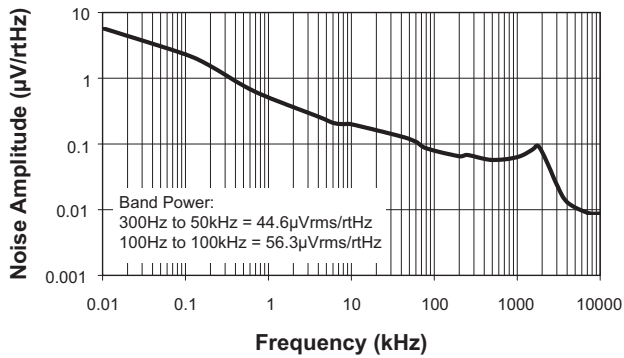

V_{IH} and V_{IL} vs. V_{IN}

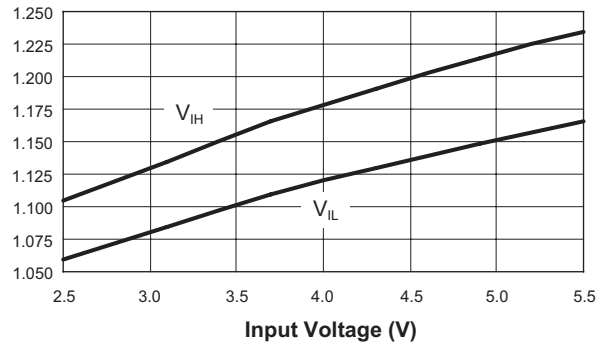

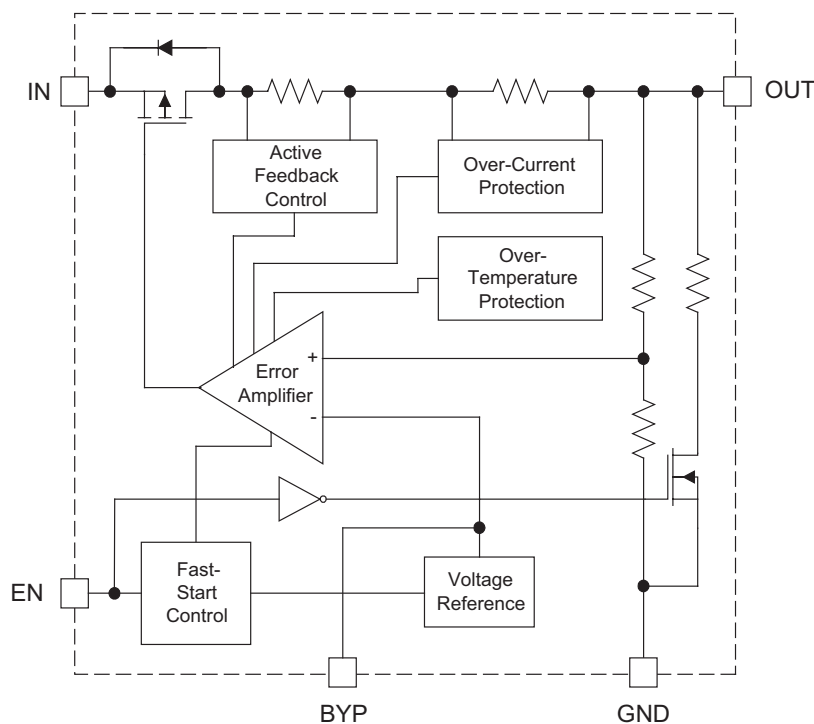
Functional Block Diagram**Functional Description**

The AAT3218 is intended for LDO regulator applications where output current load requirements range from no load to 150mA. The advanced circuit design of the AAT3218 has been specifically optimized for very fast start-up and shutdown timing. This proprietary CMOS LDO has also been tailored for superior transient response characteristics. These traits are particularly important for applications that require fast power supply timing, such as GSM cellular telephone handsets.

The high-speed turn-on capability of the AAT3218 is enabled through the implementation of a fast-start control circuit, which accelerates the power-up behavior of fundamental control and feedback circuits within the LDO regulator.

Fast turn-off response time is achieved by an active output pull-down circuit, which is enabled when the LDO regulator is placed in shutdown mode. This active fast shutdown circuit has no adverse effect on normal device operation.

The AAT3218 has very fast transient response characteristics, which is an important feature for applications where fast line and load transient response are required.

This rapid transient response behavior is accomplished through the implementation of an active error amplifier feedback control. This proprietary circuit design is unique to this MicroPower LDO regulator.

The LDO regulator output has been specifically optimized to function with low-cost, low-ESR ceramic capacitors. However, the design will allow for operation over a wide range of capacitor types.

A bypass pin has been provided to allow the addition of an optional voltage reference bypass capacitor to reduce output self noise and increase power supply ripple rejection. Device self noise and PSRR will be improved by the addition of a small ceramic capacitor to this pin. However, increased C_{BYPASS} values may slow down the LDO regulator turn-on time.

This LDO regulator has complete short-circuit and thermal protection. The integral combination of these two internal protection circuits gives the AAT3218 a comprehensive safety system to guard against extreme adverse operating conditions. Device power dissipation is limited to the package type and thermal dissipation properties. Refer to the Thermal Considerations section of this datasheet for details on device operation at maximum output current loads.

Applications Information

To assure the maximum possible performance is obtained from the AAT3218, please refer to the following application recommendations.

Input Capacitor

Typically, a 1 μ F or larger capacitor is recommended for C_{IN} in most applications. A C_{IN} capacitor is not required for basic LDO regulator operation. However, if the AAT3218 is physically located more than three centimeters from an input power source, a C_{IN} capacitor will be needed for stable operation. C_{IN} should be located as close to the device V_{IN} pin as practically possible. C_{IN} values greater than 1 μ F will offer superior input line transient response and will assist in maximizing the highest possible power supply ripple rejection.

Ceramic, tantalum, or aluminum electrolytic capacitors may be selected for C_{IN} . There is no specific capacitor ESR requirement for C_{IN} . However, for 150mA LDO regulator output operation, ceramic capacitors are recommended for C_{IN} due to their inherent capability over tantalum capacitors to withstand input current surges from low impedance sources, such as batteries in portable devices.

Output Capacitor

For proper load voltage regulation and operational stability, a capacitor is required between pins V_{OUT} and GND. The C_{OUT} capacitor connection to the LDO regulator ground pin should be made as direct as practically possible for maximum device performance.

The AAT3218 has been specifically designed to function with very low ESR ceramic capacitors. For best performance, ceramic capacitors are recommended.

Typical output capacitor values for maximum output current conditions range from 1 μ F to 10 μ F. Applications utilizing the exceptionally low output noise and optimum power supply ripple rejection characteristics of the AAT3218 should use 2.2 μ F or greater for C_{OUT} . If desired, C_{OUT} may be increased without limit.

In low output current applications where output load is less than 10mA, the minimum value for C_{OUT} can be as low as 0.47 μ F.

Bypass Capacitor and Low Noise Applications

A bypass capacitor pin is provided to enhance the low noise characteristics of the AAT3218 LDO regulator. The bypass capacitor is not necessary for operation of the AAT3218. However, for best device performance, a small ceramic capacitor should be placed between the bypass pin (BYP) and the device ground pin (GND). The value of C_{BYP} may range from 470pF to 10nF. For lowest noise and best possible power supply ripple rejection performance, a 10nF capacitor should be used. To practically realize the highest power supply ripple rejection and lowest output noise performance, it is critical that the capacitor connection between the BYP pin and GND pin be direct and PCB traces should be as short as possible. Refer to the PCB Layout Recommendations section of this data-sheet for examples.

There is a relationship between the bypass capacitor value and the LDO regulator turn-on time and turn-off time. In applications where fast device turn-on and turn-off time are desired, the value of C_{BYP} should be reduced.

In applications where low noise performance and/or ripple rejection are less of a concern, the bypass capacitor may be omitted. The fastest device turn-on time will be realized when no bypass capacitor is used.

DC leakage on this pin can affect the LDO regulator output noise and voltage regulation performance. For this reason, the use of a low leakage, high quality ceramic (NPO or COG type) or film capacitor is highly recommended.

Capacitor Characteristics

Ceramic composition capacitors are highly recommended over all other types of capacitors for use with the AAT3218. Ceramic capacitors offer many advantages over their tantalum and aluminum electrolytic counterparts. A ceramic capacitor typically has very low ESR, is lower cost, has a smaller PCB footprint, and is non-polarized. Line and load transient response of the LDO regulator is improved by using low-ESR ceramic capacitors. Since ceramic capacitors are non-polarized, they are not prone to incorrect connection damage.

Equivalent Series Resistance: ESR is a very important characteristic to consider when selecting a capacitor. ESR is the internal series resistance associated with a capacitor that includes lead resistance, internal connections, size and area, material composition, and ambi-

150mA MicroPower™ High Performance LDO

ent temperature. Typically, capacitor ESR is measured in milliohms for ceramic capacitors and can range to more than several ohms for tantalum or aluminum electrolytic capacitors.

Ceramic Capacitor Materials: Ceramic capacitors less than 0.1 μ F are typically made from NPO or COG materials. NPO and COG materials generally have tight tolerance and are very stable over temperature. Larger capacitor values are usually composed of X7R, X5R, Z5U, or Y5V dielectric materials. Large ceramic capacitors (i.e., greater than 2.2 μ F) are often available in low-cost Y5V and Z5U dielectrics. These two material types are not recommended for use with LDO regulators since the capacitor tolerance can vary more than $\pm 50\%$ over the operating temperature range of the device. A 2.2 μ F Y5V capacitor could be reduced to 1 μ F over temperature; this could cause problems for circuit operation. X7R and X5R dielectrics are much more desirable. The temperature tolerance of X7R dielectric is better than $\pm 15\%$.

Capacitor area is another contributor to ESR. Capacitors that are physically large in size will have a lower ESR when compared to a smaller sized capacitor of an equivalent material and capacitance value. These larger devices can improve circuit transient response when compared to an equal value capacitor in a smaller package size.

Consult capacitor vendor datasheets carefully when selecting capacitors for LDO regulators.

Enable Function

The AAT3218 features an LDO regulator enable/disable function. This pin (EN) is active high and is compatible with CMOS logic. To assure the LDO regulator will switch on, the EN turn-on control level must be greater than 1.5V. The LDO regulator will go into the disable shutdown mode when the voltage on the EN pin falls below 0.6V. If the enable function is not needed in a specific application, it may be tied to V_{IN} to keep the LDO regulator in a continuously on state.

When the LDO regulator is in shutdown mode, an internal 1.5k Ω resistor is connected between V_{OUT} and GND. This is intended to discharge C_{OUT} when the LDO regulator is disabled. The internal 1.5k Ω has no adverse effect on device turn-on time.

Short-Circuit Protection

The AAT3218 contains an internal short-circuit protection circuit that will trigger when the output load current exceeds the internal threshold limit. Under short-circuit

conditions, the output of the LDO regulator will be current limited until the short-circuit condition is removed from the output or LDO regulator package power dissipation exceeds the device thermal limit.

Thermal Protection

The AAT3218 has an internal thermal protection circuit which will turn on when the device die temperature exceeds 150°C. The internal thermal protection circuit will actively turn off the LDO regulator output pass device to prevent the possibility of over-temperature damage. The LDO regulator output will remain in a shutdown state until the internal die temperature falls back below the 150°C trip point.

The combination and interaction between the short-circuit and thermal protection systems allows the LDO regulator to withstand indefinite short-circuit conditions without sustaining permanent damage.

No-Load Stability

The AAT3218 is designed to maintain output voltage regulation and stability under operational no-load conditions. This is an important characteristic for applications where the output current may drop to zero.

Reverse Output-to-Input Voltage Conditions and Protection

Under normal operating conditions, a parasitic diode exists between the output and input of the LDO regulator. The input voltage should always remain greater than the output load voltage, maintaining a reverse bias on the internal parasitic diode. Conditions where V_{OUT} might exceed V_{IN} should be avoided since this would forward bias the internal parasitic diode and allow excessive current flow into the V_{OUT} pin, possibly damaging the LDO regulator.

In applications where there is a possibility of V_{OUT} exceeding V_{IN} for brief amounts of time during normal operation, the use of a larger value C_{IN} capacitor is highly recommended. A larger value of C_{IN} with respect to C_{OUT} will effect a slower C_{IN} decay rate during shutdown, thus preventing V_{OUT} from exceeding V_{IN} . In applications where there is a greater danger of V_{OUT} exceeding V_{IN} for extended periods of time, it is recommended to place a Schottky diode across V_{IN} to V_{OUT} (connecting the cathode to V_{IN} and anode to V_{OUT}). The Schottky diode forward voltage should be less than 0.45V.

150mA MicroPower™ High Performance LDO**Thermal Considerations and High Output Current Applications**

The AAT3218 is designed to deliver a continuous output load current of 150mA under normal operating conditions. The limiting characteristic for the maximum output load current safe operating area is essentially package power dissipation and the internal preset thermal limit of the device. In order to obtain high operating currents, careful device layout and circuit operating conditions must be taken into account.

The following discussions will assume the LDO regulator is mounted on a printed circuit board utilizing the minimum recommended footprint, as stated in the Layout Considerations section of this datasheet.

At any given ambient temperature (T_A), the maximum package power dissipation can be determined by the following equation:

$$P_{D(MAX)} = \frac{[T_{J(MAX)} - T_A]}{\Theta_{JA}}$$

Constants for the AAT3218 are $T_{J(MAX)}$, the maximum junction temperature for the device which is 125°C and $\Theta_{JA} = 190^\circ\text{C/W}$, the package thermal resistance. Typically, maximum conditions are calculated at the maximum operating temperature where $T_A = 85^\circ\text{C}$, under normal ambient conditions $T_A = 25^\circ\text{C}$. Given $T_A = 85^\circ\text{C}$, the maximum package power dissipation is 211mW. At $T_A = 25^\circ\text{C}$, the maximum package power dissipation is 526mW.

The maximum continuous output current for the AAT3218 is a function of the package power dissipation and the input-to-output voltage drop across the LDO regulator. Refer to the following simple equation:

$$I_{OUT(MAX)} < \frac{P_{D(MAX)}}{(V_{IN} - V_{OUT})}$$

For example, if $V_{IN} = 5\text{V}$, $V_{OUT} = 2.8\text{V}$, and $T_A = 25^\circ\text{C}$, $I_{OUT(MAX)} < 240\text{mA}$. If the output load current were to exceed 240mA or if the ambient temperature were to increase, the internal die temperature would increase. If the condition remained constant, the LDO regulator thermal protection circuit would activate.

To determine the maximum input voltage for a given load current, refer to the following equation. This calculation accounts for the total power dissipation of the LDO regulator, including that caused by ground current.

$$P_{D(MAX)} = (V_{IN} - V_{OUT}) \cdot I_{OUT} + V_{IN} \cdot I_{GND}$$

This formula can be solved for V_{IN} to determine the maximum input voltage.

$$V_{IN(MAX)} = \frac{P_{D(MAX)} + V_{OUT} \cdot I_{OUT}}{I_{OUT} + I_{GND}}$$

The following is an example for an AAT3218 set for a 2.3V output:

$$V_{OUT} = 2.3\text{V}$$

$$I_{OUT} = 150\text{mA}$$

$$I_{GND} = 150\mu\text{A}$$

$$V_{IN(MAX)} = \frac{526\text{mW} + 2.3\text{V} \cdot 150\text{mA}}{150\text{mA} + 150\mu\text{A}}$$

$$V_{IN(MAX)} = 5.8\text{V}$$

From the discussion above, $P_{D(MAX)}$ was determined to equal 526mW at $T_A = 25^\circ\text{C}$.

Thus, the AAT3218 can sustain a constant 2.3V output at a 150mA load current as long as V_{IN} is $\leq 5.8\text{V}$ at an ambient temperature of 25°C. 5.8V is the absolute maximum voltage where an AAT3218 would never be operated, thus at 25°C, the device would not have any thermal concerns or operational $V_{IN(MAX)}$ limits.

This situation can be different at 85°C. The following is an example for an AAT3218 set for a 2.3V output at 85°C:

$$V_{OUT} = 2.3\text{V}$$

$$I_{OUT} = 150\text{mA}$$

$$I_{GND} = 150\mu\text{A}$$

$$V_{IN(MAX)} = \frac{211\text{mW} + 2.3\text{V} \cdot 150\text{mA}}{150\text{mA} + 150\mu\text{A}}$$

$$V_{IN(MAX)} = 3.7\text{V}$$

150mA MicroPower™ High Performance LDO

From the discussion above, $P_{D(MAX)}$ was determined to equal 211mW at $T_A = 85^\circ\text{C}$.

Higher input-to-output voltage differentials can be obtained with the AAT3218, while maintaining device functions within the thermal safe operating area. To accomplish this, the device thermal resistance must be reduced by increasing the heat sink area or by operating the LDO regulator in a duty-cycled mode.

For example, an application requires $V_{IN} = 4.2\text{V}$ while $V_{OUT} = 2.3\text{V}$ at a 150mA load and $T_A = 85^\circ\text{C}$. V_{IN} is greater than 3.7V, which is the maximum safe continuous input level for $V_{OUT} = 2.3\text{V}$ at 150mA for $T_A = 85^\circ\text{C}$. To maintain this high input voltage and output current level, the LDO regulator must be operated in a duty-cycled mode. Refer to the following calculation for duty-cycle operation ($P_{D(MAX)}$ is assumed to be 211mW):

$$I_{GND} = 150\mu\text{A}$$

$$I_{OUT} = 150\text{mA}$$

$$V_{IN} = 4.2\text{V}$$

$$V_{OUT} = 2.3\text{V}$$

$$\%DC = \frac{P_{D(MAX)}}{(V_{IN} - V_{OUT}) \cdot I_{OUT} + V_{IN} \cdot I_{GND}}$$

$$\%DC = \frac{211\text{mW}}{(4.2\text{V} - 2.3\text{V}) \cdot 150\text{mA} + 4.2\text{V} \cdot 150\mu\text{A}}$$

$$\%DC = 73.87\%$$

For a 150mA output current and a 2.5V drop across the AAT3218 at an ambient temperature of 85°C , the maximum on-time duty cycle for the device would be 73.87%.

High Peak Output Current Applications

Some applications require the LDO regulator to operate at continuous nominal level with short duration, high-current peaks. The duty cycles for both output current levels must be taken into account. To do so, first calculate the power dissipation at the nominal continuous level, then factor in the additional power dissipation due to the short duration, high-current peaks.

For example, a 2.3V system using an AAT3218IGV-2.3-T1 operates at a continuous 100mA load current

level and has short 150mA current peaks. The current peak occurs for 378 μs out of a 4.61ms period. It will be assumed the input voltage is 4.2V.

First, the current duty cycle in percent must be calculated:

$$\% \text{ Peak Duty Cycle: } X/100 = 378\mu\text{s}/4.61\text{ms}$$

$$\% \text{ Peak Duty Cycle} = 8.2\%$$

The LDO regulator will be under the 100mA load for 91.8% of the 4.61ms period and have 150mA peaks occurring for 8.2% of the time. Next, the continuous nominal power dissipation for the 100mA load should be determined then multiplied by the duty cycle to conclude the actual power dissipation over time.

$$P_{D(MAX)} = (V_{IN} - V_{OUT}) \cdot I_{OUT} + V_{IN} \cdot I_{GND}$$

$$P_{D(100\text{mA})} = (4.2\text{V} - 2.3\text{V}) \cdot 100\text{mA} + 4.2\text{V} \cdot 150\mu\text{A}$$

$$P_{D(100\text{mA})} = 190.6\text{mW}$$

$$P_{D(91.8\%D/C)} = \%DC \cdot P_{D(100\text{mA})}$$

$$P_{D(91.8\%D/C)} = 0.918 \times 190.6\text{mW}$$

$$P_{D(91.8\%D/C)} = 175\text{mW}$$

The power dissipation for a 100mA load occurring for 91.8% of the duty cycle will be 175mW. Now the power dissipation for the remaining 8.2% of the duty cycle at the 150mA load can be calculated:

$$P_{D(MAX)} = (V_{IN} - V_{OUT}) \cdot I_{OUT} + V_{IN} \cdot I_{GND}$$

$$P_{D(150\text{mA})} = (4.2\text{V} - 2.3\text{V}) \cdot 150\text{mA} + 4.2\text{V} \cdot 150\mu\text{A}$$

$$P_{D(150\text{mA})} = 285.6\text{mW}$$

$$P_{D(8.2\%D/C)} = \%DC \times P_{D(150\text{mA})}$$

$$P_{D(8.2\%D/C)} = 0.082 \times 285.6\text{mW}$$

$$P_{D(8.2\%D/C)} = 23.4\text{mW}$$

The power dissipation for a 150mA load occurring for 8.2% of the duty cycle will be 23.4mW. Finally, the two power dissipation levels can be summed to determine the total true power dissipation under the varied load:

$$P_{D(\text{total})} = P_{D(100\text{mA})} + P_{D(150\text{mA})}$$

$$P_{D(\text{total})} = 175\text{mW} + 23.4\text{mW}$$

$$P_{D(\text{total})} = 198.4\text{mW}$$

The maximum power dissipation for the AAT3218 operating at an ambient temperature of 85°C is 211mW. The device in this example will have a total power dissipation of 198.4mW. This is well within the thermal limits for safe operation of the device.

150mA MicroPower™ High Performance LDO

Printed Circuit Board Layout Recommendations

In order to obtain the maximum performance from the AAT3218 LDO regulator, careful consideration should be given to the printed circuit board (PCB) layout. If grounding connections are not properly made, power supply ripple rejection, low output self noise, and transient response can be compromised.

Figure 1 shows a common LDO regulator layout scheme. The LDO regulator, external capacitors (C_{IN} , C_{OUT} , and C_{BYP}), and the load circuit are all connected to a common ground plane. This type of layout will work in simple applications where good power supply ripple rejection and low self noise are not a design concern. For high-performance applications, this method is not recommended.

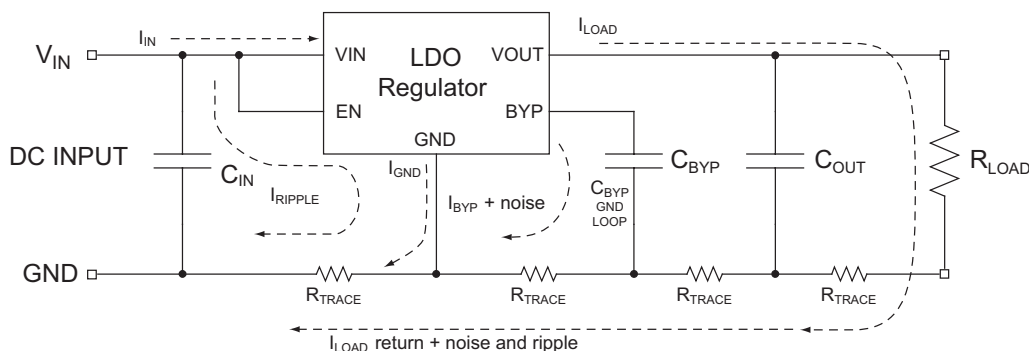

Figure 1: Common LDO Regulator Layout with C_{BYP} Ripple Feedback Loop.

The problem with the layout in Figure 1 is the bypass capacitor and output capacitor share the same ground path to the LDO regulator ground pin, along with the high-current return path from the load back to the power supply. The bypass capacitor node is connected directly to the LDO regulator internal reference, making this node very sensitive to noise or ripple. The internal reference output is fed into the error amplifier, thus any noise or ripple from the bypass capacitor will be subsequently amplified by the gain of the error amplifier. This effect can increase noise seen on the LDO regulator output, as well as reduce the maximum possible power supply ripple rejection. There is PCB trace impedance between the bypass capacitor connection to ground and the LDO regulator ground connection. When the high load current returns through this path, a small ripple voltage is created, feeding into the C_{BYP} loop.

Figure 2 shows the preferred method for the bypass and output capacitor connections. For low output noise and highest possible power supply ripple rejection performance, it is critical to connect the bypass and output capacitor directly to the LDO regulator ground pin. This method will eliminate any load noise or ripple current feedback through the LDO regulator.

Evaluation Board Layout

The AAT3218 evaluation layout follows the recommended printed circuit board layout procedures and can be used as an example for good application layouts.

Note: Board layout is not shown to scale.

AAT3218

150mA MicroPower™ High Performance LDO

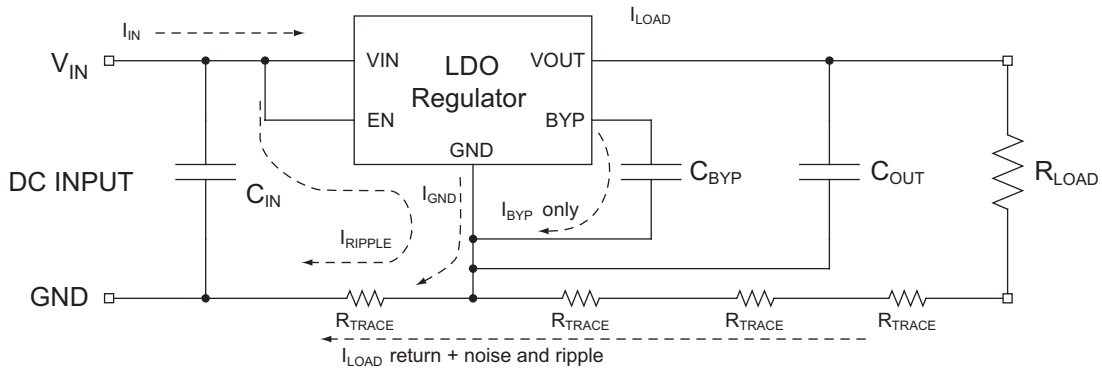

Figure 2: Recommended LDO Regulator Layout.

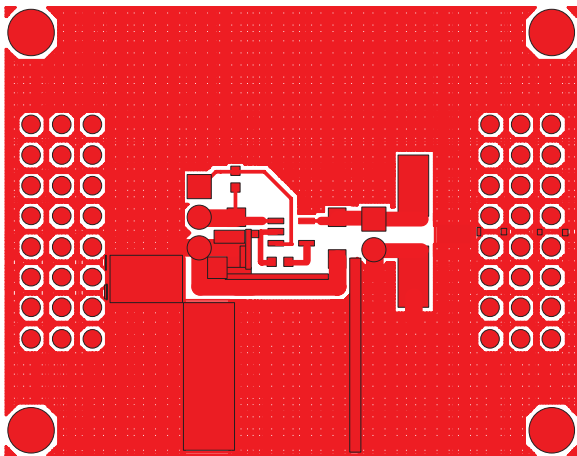

Figure 3: Evaluation Board Component Side Layout.

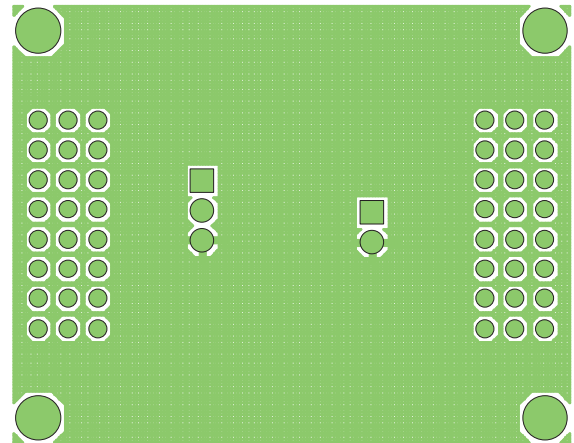

Figure 4: Evaluation Board Solder Side Layout.

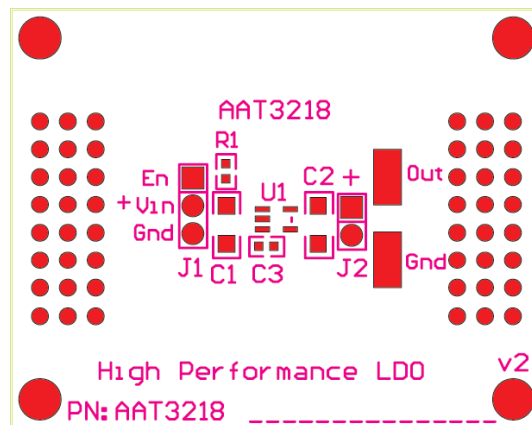

Figure 5: Evaluation Board Top Side Silk Screen Layout / Assembly Drawing.

AAT3218

150mA MicroPower™ High Performance LDO

Ordering Information

Output Voltage	Package	Marking ¹	Part Number (Tape and Reel) ²
1.2V	SOT23-5	KWXY	AAT3218IGV-1.2-T1
2.3V			AAT3218IGV-2.3-T1
2.8V		EMXY	AAT3218IGV-2.8-T1
2.85V		HOXY	AAT3218IGV-2.85-T1
3.5V			AAT3218IGV-3.5-T1
1.2V	SC70JW-8	KWXY	AAT3218IJS-1.2-T1
2.3V			AAT3218IJS-2.3-T1
3.5V			AAT3218IJS-3.5-T1



Skyworks Green™ products are compliant with all applicable legislation and are halogen-free. For additional information, refer to *Skyworks Definition of Green™*, document number SQ04-0074.

Package Information

SOT23-5

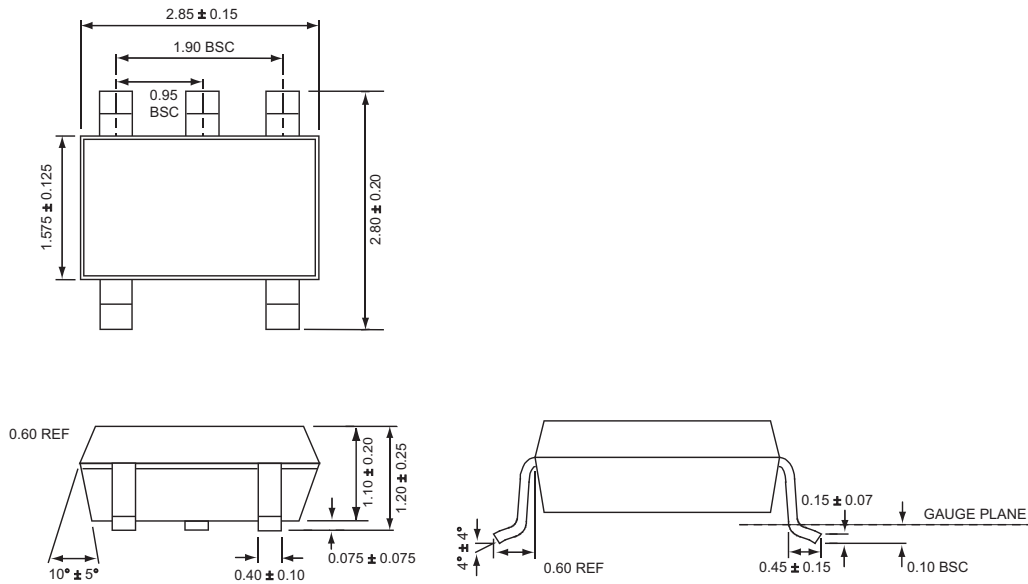

All dimensions in millimeters.

1. XYY = assembly and date code.
2. Sample stock is generally held on part numbers listed in **BOLD**.

150mA MicroPower™ High Performance LDO

SC70JW-8

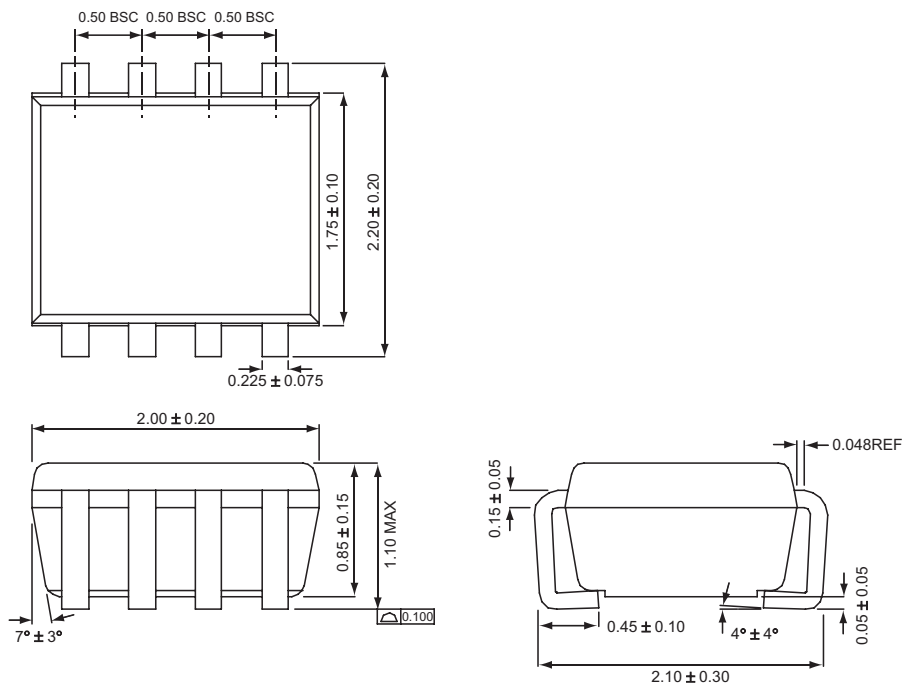

All dimensions in millimeters.

Copyright © 2012 Skyworks Solutions, Inc. All Rights Reserved.

Information in this document is provided in connection with Skyworks Solutions, Inc. ("Skyworks") products or services. These materials, including the information contained herein, are provided by Skyworks as a service to its customers and may be used for informational purposes only by the customer. Skyworks assumes no responsibility for errors or omissions in these materials or the information contained herein. Skyworks may change its documentation, products, services, specifications or product descriptions at any time, without notice. Skyworks makes no commitment to update the materials or information and shall have no responsibility whatsoever for conflicts, incompatibilities, or other difficulties arising from any future changes.

No license, whether express, implied, by estoppel or otherwise, is granted to any intellectual property rights by this document. Skyworks assumes no liability for any materials, products or information provided hereunder, including the sale, distribution, reproduction or use of Skyworks products, information or materials, except as may be provided in Skyworks Terms and Conditions of Sale.

THE MATERIALS, PRODUCTS AND INFORMATION ARE PROVIDED "AS IS" WITHOUT WARRANTY OF ANY KIND, WHETHER EXPRESS, IMPLIED, STATUTORY, OR OTHERWISE, INCLUDING FITNESS FOR A PARTICULAR PURPOSE OR USE, MERCHANTABILITY, PERFORMANCE, QUALITY OR NON-INFRINGEMENT OF ANY INTELLECTUAL PROPERTY RIGHT; ALL SUCH WARRANTIES ARE HEREBY EXPRESSLY DISCLAIMED. SKYWORKS DOES NOT WARRANT THE ACCURACY OR COMPLETENESS OF THE INFORMATION, TEXT, GRAPHICS OR OTHER ITEMS CONTAINED WITHIN THESE MATERIALS. SKYWORKS SHALL NOT BE LIABLE FOR ANY DAMAGES, INCLUDING BUT NOT LIMITED TO ANY SPECIAL, INDIRECT, INCIDENTAL, STATUTORY, OR CONSEQUENTIAL DAMAGES, INCLUDING WITHOUT LIMITATION, LOST REVENUES OR LOST PROFITS THAT MAY RESULT FROM THE USE OF THE MATERIALS OR INFORMATION, WHETHER OR NOT THE RECIPIENT OF MATERIALS HAS BEEN ADVISED OF THE POSSIBILITY OF SUCH DAMAGE.

Skyworks products are not intended for use in medical, lifesaving or life-sustaining applications, or other equipment in which the failure of the Skyworks products could lead to personal injury, death, physical or environmental damage. Skyworks customers using or selling Skyworks products for use in such applications do so at their own risk and agree to fully indemnify Skyworks for any damages resulting from such improper use or sale.

Customers are responsible for their products and applications using Skyworks products, which may deviate from published specifications as a result of design defects, errors, or operation of products outside of published parameters or design specifications. Customers should include design and operating safeguards to minimize these and other risks. Skyworks assumes no liability for applications assistance, customer product design, or damage to any equipment resulting from the use of Skyworks products outside of stated published specifications or parameters.

Skyworks, the Skyworks symbol, and "Breakthrough Simplicity" are trademarks or registered trademarks of Skyworks Solutions, Inc., in the United States and other countries. Third-party brands and names are for identification purposes only, and are the property of their respective owners. Additional information, including relevant terms and conditions, posted at www.skyworksinc.com, are incorporated by reference.

Looking for pricing, stock, or lifecycle information?

Click below to explore more details on WIN SOURCE:

- ⊖ [View AAT3218IGV-2.8-T1 on WIN SOURCE](#)
- ⊖ [Skyworks Solutions Inc. Information](#)

Optimize Your Supply Chain with WIN SOURCE Solutions

- ✓ Global Sourcing Solution
- ✓ Obsolete Management
- ✓ Cost Control Management
- ✓ Shortage Management
- ✓ Alternative Solution
- ✓ Excess Inventory Management