



**THE DATASHEET OF  
XC6371C502PR**



## PWM, PWM/PFM Controlled Step-up DC/DC Converters

☆GreenOperation Compatible

## ■GENERAL DESCRIPTION

The XC6371/XC6372 series is a group of PWM controlled and PWM/PFM controlled step-up DC/DC converters. The built-in  $1.4\Omega$  switching transistor type enables a step-up circuit to be configured using only three components, a coil, a diode, and a capacitor.

Output voltage can be selectable in the range from 2.0V to 7.0V in increments of 0.01V (accuracy:  $\pm 2.5\%$ ). Oscillation frequency is also selectable from 50kHz, 100kHz, and 180kHz (accuracy:  $\pm 15\%$ ) for the XC6371 and the XC6372 series. Soft-start time is internally set and offers protection against in-rush currents when the power is switched on and prevents voltage overshoot. Packages with CE (chip enable) pin are also available which can reduce the IC power consumption during during stand-by mode.

The XC6371 series is the standard PWM controlled products. The control of the XC6372 series switches from PWM to PFM control during light loads when automatically switching is selected and the series is highly efficient from light loads to large output currents.

## ■APPLICATIONS

- Smart phones / Mobile phones
- Note PCs / Tablet PCs
- Digital still cameras / Camcorders
- Mobile devices / terminals

## ■FEATURES

- Operation Start Voltage Range : 0.9V~10V
- Output Voltage Range : 2.0V~7.0V (0.1V increments)
- Highly Accurate :  $\pm 2.5\%$
- Oscillation Frequency : 50kHz, 100kHz, 180kHz ( $\pm 15\%$ )
- Maximum Output Currents : 100mA(TYP.) @  $V_{IN}=3.0V$ ,  $V_{OUT}=5.0V$  \*
- Highly Efficient : 85%(TYP.) @  $V_{IN}=3.0V$ ,  $V_{OUT}=5.0V$  \*
- Built-in switching transistor.
- CE pin type (XC6371C, XC6372C)
- Phase compensation and soft start-up circuits built-in
- CMOS Low Power Consumption
- Packages : SOT-89, SOT-89-5, USP-6B
- Environmentally Friendly: EU RoHS Compliant, Pb Free
- \* Performance depends on external components and PCB layout.

## ■TYPICAL APPLICATION CIRCUIT



## ■TYPICAL PERFORMANCE CHARACTERISTICS



## PIN CONFIGURATION



\*The dissipation pad for the USP-6B package should be solder-plated in recommended mount pattern and metal masking so as to enhance mounting strength and heat release. If the pad needs to be connected to other pins, it should be connected to the pin No.1.

## PIN ASSIGNMENT

XC6371/XC6372A

PIN NUMBER		PIN NAME	FUNCTION
SOT-89	USP-6B		
1	6	VSS	Ground
2	1	VOUT	Output Voltage Monitor/IC Internal Power Supply
3	4	Lx	Switch
—	2, 3, 5	NC	No Connection

XC6371/XC6372C

PIN NUMBER		PIN NAME	FUNCTION
SOT-89-5	USP-6B		
5	6	VSS	Ground
2	1	VOUT	Output Voltage Monitor/IC Internal Power Supply
4	4	Lx	Switch
3	3	CE	Chip Enable
1	2, 5	NC	No Connection

## ■ PRODUCT CLASSIFICATION

### ● Selection Guide



### ● Ordering Information

XC6371①②③④⑤⑥-⑦<sup>(\*)</sup> : PWM controlled

XC6372①②③④⑤⑥-⑦<sup>(\*)</sup> : PWM/PFM switching control

DESIGNATOR	DESCRIPTION	SYMBOL	DESCRIPTION
①	Type of DC/DC Converter	A	3-pin DC/DC converter with built-in switching transistor
		C	Stand-by capability with built-in switching transistor
②③	Output Voltage	Integer	e.g. V <sub>OUT</sub> =3.5V→②=3, ③=5
④	Oscillation Frequency	0	50kHz
		1	100kHz
		2	180kHz
⑤⑥-⑦	Packages Taping Type <sup>(2)</sup>	PR	SOT-89 (XC6371/72 A type)
			SOT-89-5 (XC6371/72 C type)
		PR-G	SOT-89 (XC6371/72 A type)
			SOT-89-5 (XC6371/72 C type)
		DR	USP-6B
DR-G	USP-6B		

<sup>(\*)</sup> The "-G" suffix indicates that the products are Halogen and Antimony free as well as being fully EU RoHS compliant.

<sup>(2)</sup> The device orientation is fixed in its embossed tape pocket. For reverse orientation, please contact your local Torex sales office or representative. (Standard orientation: ⑤R-⑦, Reverse orientation: ⑤L-⑦)

## ■ BLOCK DIAGRAMS

XC6371/XC6372A, C

(The VOUT pin serves also as VDD)



Note: The CE pin is only used with the XC6371C.

XC6371/72/73E

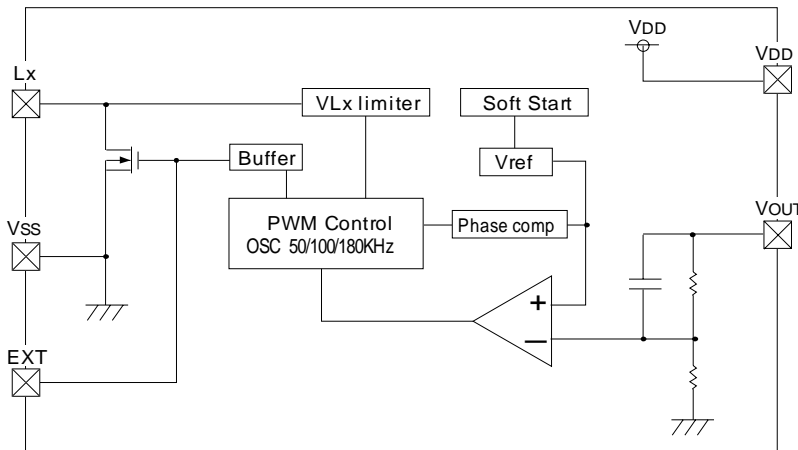

Note: Built-in transistor type units use the Lx pin.

## ■ ABSOLUTE MAXIMUM RATINGS

Ta=25°C

PARAMETER	SYMBOL	RATINGS	UNITS
Vout Input Voltage	Vout	12	V
Lx pin Voltage	VLX	12	V
Lx pin Current	ILX	400	mA
CE Input Voltage	VCE	12	V
Power Dissipation	SOT-89, SOT-89-5	500	mW
	USP-6B	100	
VDD Input Voltage	VDD	12	V
Operating Temperature Range	Topr	-30~+80	°C
Storage Temperature Range	Tstg	-40~+125	°C

## ■ ELECTRICAL CHARACTERISTICS

XC6371/72A501		V <sub>OUT</sub> =5.0V, FOSC=100kHz		T <sub>a</sub> =25°C		
PARAMETER	SYMBOL	CONDITIONS	MIN.	TYP.	MAX.	UNITS
Output Voltage	V <sub>OUT</sub>		4.875	5.000	5.125	V
Maximum Input Voltage	V <sub>IN</sub>		10	-	-	V
Operation Start Voltage	V <sub>ST1</sub>	External Components Connected, I <sub>OUT</sub> =1mA	-	-	0.90	V
Oscillation Start Voltage	V <sub>ST2</sub>	No external components. Apply voltage to V <sub>OUT</sub> Lx : 10kΩ pull-up to 5V	-	-	0.80	V
No Load Input Current	I <sub>IN</sub>	V <sub>IN</sub> =V <sub>OUT</sub> × 0.8, I <sub>OUT</sub> =0mA <sup>(*)1</sup>	-	12.8	25.7	μA
Supply Current 1	I <sub>DD1</sub>	Same as V <sub>ST2</sub> , Apply output voltage × 0.95 to V <sub>OUT</sub>	-	80.2	133.8	μA
Supply Current 2	I <sub>DD2</sub>	Same as V <sub>ST2</sub> , Apply output voltage × 1.1 to V <sub>OUT</sub>	-	8.2	16.5	μA
Lx Switch-On Resistance	R <sub>SWON</sub>	Same as I <sub>DD1</sub> , V <sub>LX</sub> =0.4V	-	1.4	2.4	Ω
Lx Leak Current	I <sub>LXL</sub>	No external components. V <sub>OUT</sub> =V <sub>LX</sub> =10V	-	-	1.0	μA
Oscillation Frequency	FOSC	Same as I <sub>DD1</sub> . Measuring of Lx waveform	85	100	115	kHz
Maximum Duty Ratio	MAXDTY	Same as I <sub>DD1</sub> . Measuring of Lx waveform	80	87	92	%
PFM Duty Ratio <sup>(*)4</sup>	PFMDTY	Same as I <sub>DD1</sub> . Measuring of Lx waveform	10	17	25	%
Lx Limit Voltage	V <sub>LXLMT</sub>	Same as I <sub>DD1</sub> . Apply output voltage to Lx, Voltage required to produce FOSC × 2	0.7	-	1.3	V
Efficiency	EFFI		-	85	-	%
Slow-Start Time	T <sub>SS</sub>		4.0	10.0	20.0	ms

NOTE: Unless otherwise stated, V<sub>IN</sub>=V<sub>OUT</sub> × 0.6, I<sub>OUT</sub>=50mA. See Typical Application Circuits, Circuit1

\*1: The Schottky diode (SD) must be type MA735, with reverse current (I<sub>R</sub>)<1.0 μA at reverse voltage (V<sub>R</sub>)=10.0V.(XC6372A)

\*2: "Supply Current 1" is the supply current while the oscillator is continuously oscillating. In actual operation the oscillator periodically operates which results in less average power consumption. The current actually provided by an external V<sub>IN</sub> source is represented by "No Load Input Current (I<sub>IN</sub>)".

\*3: When PWM operates at PWM Mode.

\*4: When PFM operates at PFM Mode.(XC6372A)

## ELECTRICAL CHARACTERISTICS (Continued)

XC6371/72C501

V<sub>OUT</sub>=5.0V, FOSC=100kHz

T<sub>a</sub>=25°C

PARAMETER	SYMBOL	CONDITIONS	MIN.	TYP.	MAX.	UNITS
Output Voltage	V <sub>OUT</sub>		4.875	5.000	5.125	V
Maximum Input Voltage	V <sub>IN</sub>		10	-	-	V
Operation Start Voltage	V <sub>ST1</sub>	External Components Connected, I <sub>OUT</sub> =1mA	-	-	0.90	V
Operation Start Voltage	V <sub>ST2</sub>	No external components. Apply voltage to V <sub>OUT</sub> , L <sub>x</sub> : 10kΩ pull-up to 5V	-	-	0.80	V
No Load Input Current	I <sub>IN</sub>	V <sub>IN</sub> =V <sub>OUT</sub> × 0.8, I <sub>OUT</sub> =0mA <sup>(*1)</sup>	-	12.8	25.7	μA
Supply Current 1	I <sub>DD1</sub>	Same as V <sub>ST2</sub> , Apply output voltage × 0.95 to V <sub>OUT</sub>	-	80.2	133.8	μA
Supply Current 2	I <sub>DD2</sub>	Same as V <sub>ST2</sub> , Apply output voltage × 1.1 to V <sub>OUT</sub>	-	8.2	16.5	μA
Lx Switch-On Resistance	R <sub>SWON</sub>	Same as I <sub>DD1</sub> , V <sub>Lx</sub> =0.4V	-	1.4	2.4	Ω
Lx Leak Current	I <sub>LXL</sub>	No external components, V <sub>OUT</sub> =V <sub>Lx</sub> =10V	-	-	1.0	μA
Oscillation Frequency	FOSC	Same as I <sub>DD1</sub> , Measuring of Lx waveform	85	100	115	KHZ
Maximum Duty Ratio	MAXDTY	Same as I <sub>DD1</sub> , Measuring of Lx waveform	80	87	92	%
PFM Duty Ratio <sup>(*4)</sup>	PFMDTY	Same as I <sub>DD1</sub> , Measuring of Lx waveform	10	17	25	%
Stand-by Current	I <sub>STB</sub>	Same as I <sub>DD1</sub>	-	-	0.5	μA
CE "High" Voltage	V <sub>CEH</sub>	Same as I <sub>DD1</sub> , Lx Oscillation start	0.75	-	-	V
CE "Low" Voltage	V <sub>CEL</sub>	Same as I <sub>DD1</sub> , Lx Oscillation stop	-	-	0.20	V
CE "High" Current	I <sub>CEH</sub>	Same as I <sub>DD1</sub> , V <sub>CE</sub> =V <sub>OUT</sub> × 0.95	-	-	0.25	μA
CE "Low" Current	I <sub>CEL</sub>	Same as I <sub>DD1</sub> , V <sub>CE</sub> =0V	-	-	-0.25	μA
Lx Limit Voltage	V <sub>LxLMT</sub>	Same as I <sub>DD1</sub> , Apply output voltage to Lx, Voltage required to produce FOSC × 2	0.7	-	1.3	V
Efficiency	EFFI		-	85	-	%
Slow-Start Time	T <sub>SS</sub>		4.0	10.0	20.0	ms

NOTE: Unless otherwise stated, connect CE to V<sub>OUT</sub>, V<sub>IN</sub>=V<sub>OUT</sub> × 0.6, I<sub>OUT</sub>=50mA. See Typical Application Circuits, Circuit 2.

\*1: The Schottky diode (SD) must be type MA735, with reverse current (I<sub>R</sub>)<1.0μA at reverse voltage (V<sub>R</sub>)=10.0V.(XC6372C)

\*2: "Supply Current 1" is the supply current while the oscillator is continuously oscillating. In actual operation the oscillator periodically operates which results in less average power consumption. The current actually provided by an external V<sub>IN</sub> source is represented by "No Load Input Current (I<sub>IN</sub>)".

\*3: When PWM operates at PWM Mode.

\*4: When PFM operates at PFM Mode.(XC6372C)

## ■ TYPICAL APPLICATION CIRCUITS

Circuit 1: XC6372A series

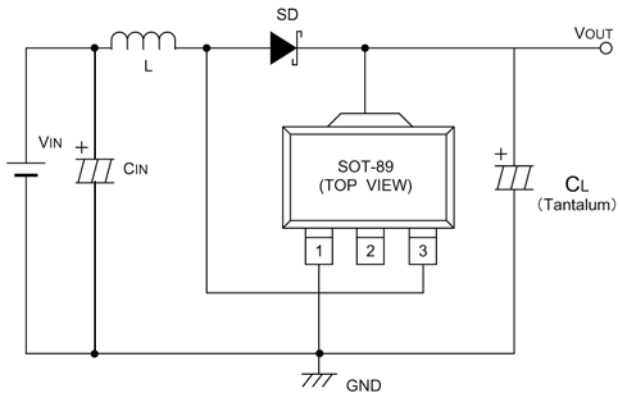

- L : 100  $\mu$  H (SUMIDA, CR54)
- SD : MA2Q735 (Schottky diode; MATSUSHITA)
- CL : 16V 47  $\mu$  F (Tantalum capacitor, NICHICHEMI MCE)
- CIN : 16V 220  $\mu$  F (Aluminium Electrolytic Capacitor)

Circuit 2: XC6372C series

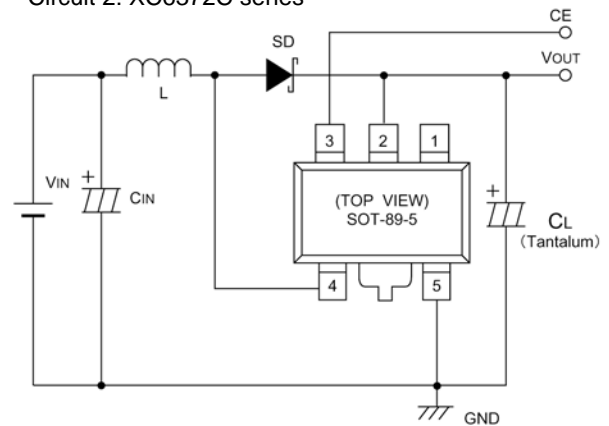

- L : 100  $\mu$  H (CR54, SUMIDA)
- SD : MA2Q735 (Schottky Diode; MATSUSHITA)
- CL : 16V 47  $\mu$  F (Tantalum Capacitor, NICHICHEMI MCE)
- CIN : 16V 220  $\mu$  F (Aluminium Electrolytic Capacitor)

## TYPICAL PERFORMANCE CHARACTERISTICS

(1) Output Voltage vs. Output Current



## ■ TYPICAL PERFORMANCE CHARACTERISTICS (Continued)

### (2) Efficiency vs. Output Current

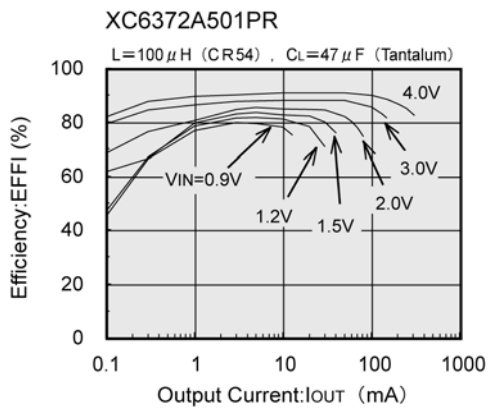

## TYPICAL PERFORMANCE CHARACTERISTICS (Continued)

### (3) Ripple Voltage vs. Output Current



■ **TYPICAL PERFORMANCE CHARACTERISTICS (Continued)**

(4) No Load Input Current vs. Input Voltage



## TYPICAL PERFORMANCE CHARACTERISTICS (Continued)

(5) Operation Start Voltage / Hold Voltage vs. Output Current



(6) Load Transient Response



## PACKAGING INFORMATION

### ● SOT-89



### ● SOT-89-5



### ● USP-6B



## PACKAGING INFORMATION (Continued)

● USP-6B Reference Pattern Layout



● USP-6B Reference Metal Mask Design

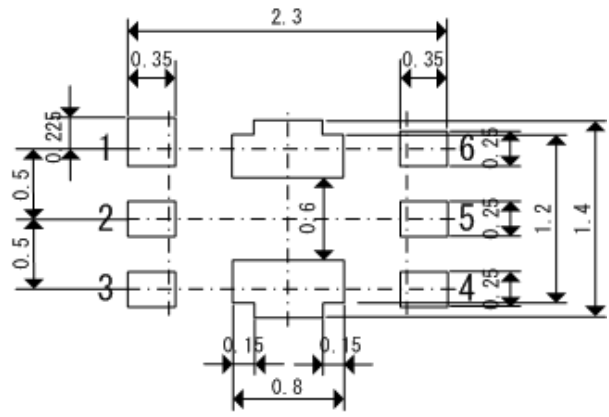

## MARKING RULE

[XC6371/XC6372]

● SOT-89, SOT-89-5



SOT-89  
(TOP VIEW)



SOT-89-5  
(TOP VIEW)

① represents product series

MARK	PRODUCT SERIES
A	XC6371A
A	XC6371C

MARK	PRODUCT SERIES
1	XC6372A
1	XC6372C

② represents integer of output voltage and oscillation frequency

OUTPUT VOLTAGE (V)	OSCILLATION FREQUENCY		
	50kHz	100kHz	180kHz
1.x	B	1	1
2.x	C	2	2
3.x	F	3	3
4.x	E	4	4
5.x	F	5	5
6.x	H	6	6
7.x	K	7	7

③ represents decimal number of output voltage and oscillation frequency

OUTPUT VOLTAGE (V)	OSCILLATION FREQUENCY		
	50kHz	100kHz	180kHz
x.0	0	0	A
x.1	1	1	B
x.2	2	2	C
x.3	3	3	D
x.4	4	4	E
x.5	5	5	F
x.6	6	6	H
x.7	7	7	K
x.8	8	8	L
x.9	9	9	M

④ represents production lot number

0 to 9, A to Z repeated (G, I, J, O, Q, W excluded).

## MARKING RULE (Continued)

[XC6371/XC6372] (Continued)

### ● USP-6B



USP-6B  
(TOP VIEW)

① represents product series

MARK	PRODUCT SERIES
5	XC6371xxxxDx
2	XC6372xxxxDx

② represents product classification

MARK	PRODUCT SERIES
A	XC6371A
C	XC6371C

③④ represents output voltage (ex.)

MARK		OUTPUT VOLTAGE (V)
③	④	
3	3	3.3
5	0	5.0

⑤ represents oscillation frequency

MARK	OSCILLATION FREQUENCY (kHz)
0	50
1	100
2	180

⑥ represents production lot number

0 to 9, A to Z repeated (G, I, J, O, Q, W excluded)



Note: No character inversion used.

1. The products and product specifications contained herein are subject to change without notice to improve performance characteristics. Consult us, or our representatives before use, to confirm that the information in this datasheet is up to date.
2. We assume no responsibility for any infringement of patents, patent rights, or other rights arising from the use of any information and circuitry in this datasheet.
3. Please ensure suitable shipping controls (including fail-safe designs and aging protection) are in force for equipment employing products listed in this datasheet.
4. The products in this datasheet are not developed, designed, or approved for use with such equipment whose failure or malfunction can be reasonably expected to directly endanger the life of, or cause significant injury to, the user.  
(e.g. Atomic energy; aerospace; transport; combustion and associated safety equipment thereof.)
5. Please use the products listed in this datasheet within the specified ranges.  
Should you wish to use the products under conditions exceeding the specifications, please consult us or our representatives.
6. We assume no responsibility for damage or loss due to abnormal use.
7. All rights reserved. No part of this datasheet may be copied or reproduced without the prior permission of TOREX SEMICONDUCTOR LTD.

**TOREX SEMICONDUCTOR LTD.**

## Looking for pricing, stock, or lifecycle information?

Click below to explore more details on WIN SOURCE:

-  [View XC6371C502PR on WIN SOURCE](#)
-  [Torex Semiconductor Ltd Information](#)

## Optimize Your Supply Chain with WIN SOURCE Solutions

-  Global Sourcing Solution
-  Obsolete Management
-  Cost Control Management
-  Shortage Management
-  Alternative Solution
-  Excess Inventory Management