

300mA MicroPower™ LDO with PowerOK

General Description

The AAT3237 MicroPower low dropout (LDO) linear regulator is ideally suited for portable applications where low noise, extended battery life, and small size are critical. The AAT3237 has been specifically designed for low output noise performance, fast transient response, and high power supply rejection ratio (PSRR).

Other features include low quiescent current, typically 70µA, and low dropout voltage, typically less than 400mV at full output current. The device is output short-circuit protected and has a thermal shutdown circuit for additional protection under extreme conditions.

The AAT3237 also features a low-power shutdown mode for extended battery life. A Power-OK open-drain output signals when V_{OUT} is in regulation.

The AAT3237 is available in a Pb-free, space-saving 6-pin SOT23 or 8-pin SC70JW package in 13 factory-programmed voltages: 1.2V, 1.5V, 1.8V, 2.0V, 2.3V, 2.5V, 2.7V, 2.8V, 2.85V, 2.9V, 3.0V, 3.3V, or 3.5V.

Features

- Low Dropout: 400mV at 300mA
- Guaranteed 300mA Output
- High Accuracy $\pm 1.5\%$
- 70µA Quiescent Current
- High Power Supply Ripple Rejection
- Power-OK (POK) Output
- Fast Line and Load Transient Response
- Short-Circuit Protection
- Over-Temperature Protection
- Uses Low Equivalent Series Resistance (ESR) Ceramic Capacitors
- Shutdown Mode for Longer Battery Life
- Low Temperature Coefficient
- 13 Factory-Programmed Output Voltages
- SOT23 6-Pin or SC70JW 8-Pin Package

Applications

- Cellular Phones
- Desktop Computers
- Digital Cameras
- Notebook Computers
- Personal Portable Electronics
- Portable Communication Devices

Typical Application

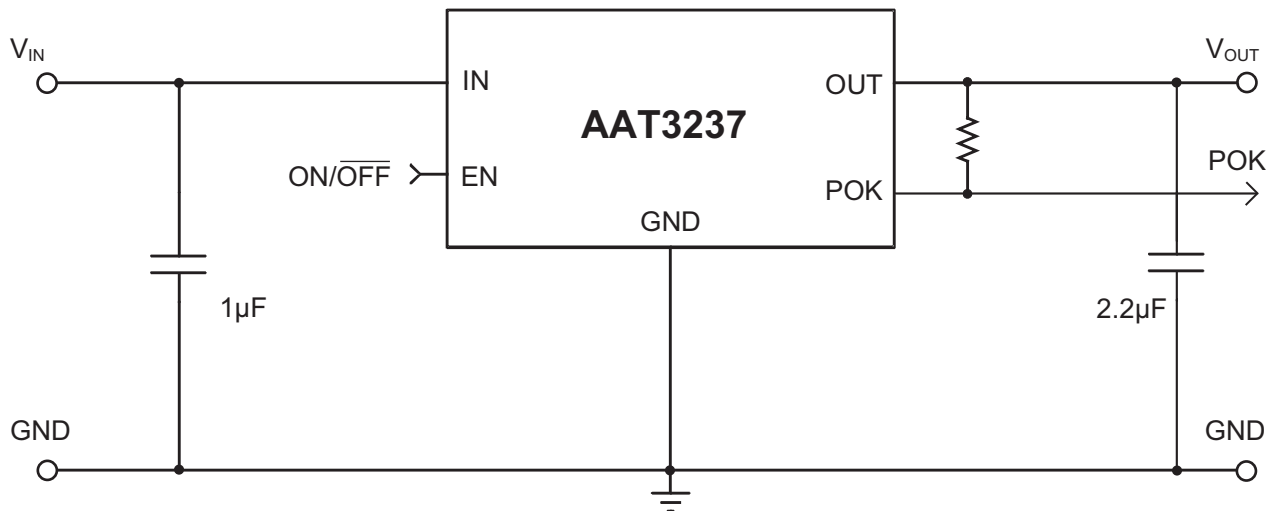

AAT3237

300mA MicroPower™ LDO with PowerOK

Pin Descriptions

Pin Number		Symbol	Function
SOT23-6	SC70JW-8		
1	5, 6	IN	Input voltage pin; should be decoupled with 1μF or greater capacitor.
2, 5	8	GND	Ground connection pin.
3	7	EN	Enable pin; this pin should not be left floating. When pulled low, the PMOS pass transistor turns off and all internal circuitry enters low-power mode, consuming less than 1μA.
4	1	POK	Power-OK output. This open-drain output is low when OUT is out of regulation. Connect a pull-up resistor from POK to OUT.
6	2, 3, 4	OUT	Output pin; should be decoupled with 2.2μF ceramic capacitor.

Pin Configuration

**SOT23-6
(Top View)**

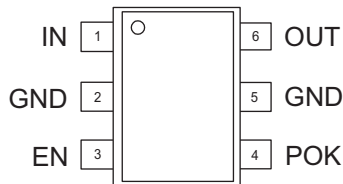

**SC70JW-8
(Top View)**

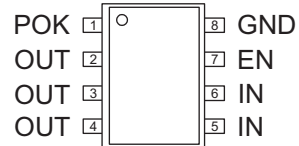

Absolute Maximum Ratings¹

$T_A = 25^\circ\text{C}$, unless otherwise noted.

Symbol	Description	Value	Units
$V_{IN, POK}$	Input Voltage, POK	6	V
$V_{ENIN(MAX)}$	Maximum EN to Input Voltage	0.3	
I_{OUT}	DC Output Current	$P_D / (V_{IN} - V_O)$	mA
T_J	Operating Junction Temperature Range	-40 to 150	°C
T_{LEAD}	Maximum Soldering Temperature (at leads, 10 sec.)	300	

Thermal Information²

Symbol	Description	Rating	Units
Θ_{JA}	Maximum Thermal Resistance (SOT23-6, SC70JW-8)	150	°C/W
P_D	Maximum Power Dissipation (SOT23-6, SC70JW-8)	667	mW

Recommended Operating Conditions

Symbol	Description	Rating	Units
V_{IN}	Input Voltage ³	$(V_{OUT} + V_{DO})$ to 5.5	V
T	Ambient Temperature Range	-40 to +85	°C

1. Stresses above those listed in Absolute Maximum Ratings may cause permanent damage to the device. Functional operation at conditions other than the operating conditions specified is not implied.

2. Mounted on a demo board.

3. To calculate minimum input voltage, use the following equation: $V_{IN(MIN)} = V_{OUT(MAX)} + V_{DO(MAX)}$ as long as $V_{IN} \geq 2.5\text{V}$.

Electrical Characteristics

$V_{IN} = V_{OUT(NOM)} + 1V$ for V_{OUT} options greater than 1.5V. $V_{IN} = 2.5V$ for $V_{OUT} \leq 1.5V$. $I_{OUT} = 1mA$, $C_{OUT} = 2.2\mu F$, $C_{IN} = 1\mu F$, $T_A = -40^\circ C$ to $+85^\circ C$, unless otherwise noted. Typical values are $T_A = 25^\circ C$.

Symbol	Description	Conditions	Min	Typ	Max	Units	
V_{OUT}	Output Voltage Tolerance	$I_{OUT} = 1mA$ to $300mA$	$T_A = 25^\circ C$	-1.5		1.5	%
			$T_A = -40$ to $85^\circ C$	-2.5		2.5	
I_{OUT}	Output Current	$V_{OUT} > 1.2V$	300			mA	
V_{DO}	Dropout Voltage ^{1, 2}	$I_{OUT} = 300mA$		400	600	mV	
I_{SC}	Short-Circuit Current	$V_{OUT} < 0.4V$		600		mA	
I_Q	Ground Current	$V_{IN} = 5V$, No Load, $EN = V_{IN}$		70	125	μA	
I_{SD}	Shutdown Current	$V_{IN} = 5V$, $EN = 0V$			1		
$\frac{\Delta V_{OUT}}{V_{OUT}} \cdot \Delta V_{IN}$	Line Regulation ³	$V_{IN} = V_{OUT} + 1$ to $5.0V$			0.09	%/V	
$\Delta V_{OUT}(\text{line})$	Dynamic Line Regulation	$V_{IN} = V_{OUT} + 1V$ to $V_{OUT} + 2V$, $I_{OUT} = 300mA$, $T_R/T_F = 2\mu s$		5		mV	
$\Delta V_{OUT}(\text{load})$	Dynamic Load Regulation	$I_{OUT} = 1mA$ to $300mA$, $T_R < 5\mu s$		60			
$V_{EN(L)}$	Enable Threshold Low				0.6	V	
$V_{EN(H)}$	Enable Threshold High		1.5				
I_{EN}	Leakage Current on Enable Pin	$V_{EN} = 5V$			1	μA	
V_{POK}	POK Trip Threshold	V_{OUT} Rising, $T_A = 25^\circ C$	90	94	98	% of V_{OUT}	
V_{POKHYS}	POK Hysteresis			1		V_{OUT}	
$V_{POK(OL)}$	POK Output Voltage Low	$I_{SINK} = 1mA$			0.4	V	
I_{POK}	POK Output Leakage Current	$V_{POK} < 5.5V$, V_{OUT} in Regulation			1	μA	
PSRR	Power Supply Rejection Ratio	$I_{OUT} = 10mA$	1kHz		65	dB	
			10kHz		45		
			1MHz		42		
T_{SD}	Over-Temperature Shutdown Threshold			145		$^\circ C$	
T_{HYS}	Over-Temperature Shutdown Hysteresis			12			
e_N	Output Noise			250		μV_{rms}	
TC	Output Voltage Temperature Coefficient			22		ppm/ $^\circ C$	

1. V_{DO} is defined as $V_{IN} - V_{OUT}$ when V_{OUT} is 98% of nominal.

2. For $V_{OUT} < 2.1V$, $V_{DO} = 2.5V - V_{OUT}$.

3. $C_{IN} = 10\mu F$.

Typical Characteristics

Unless otherwise noted, $V_{IN} = 5V$, $T_A = 25^\circ C$.

Dropout Voltage vs. Temperature

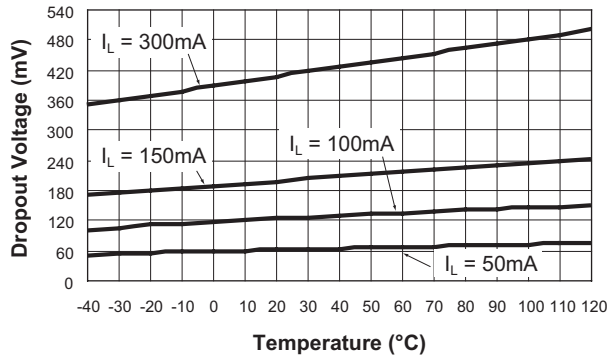

Dropout Characteristics

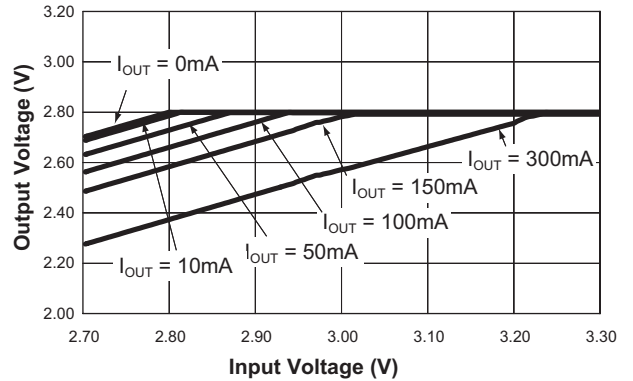

Dropout Voltage vs. Output Current

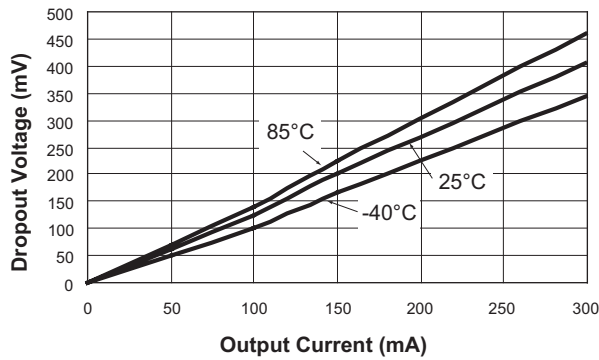

Ground Current vs. Input Voltage

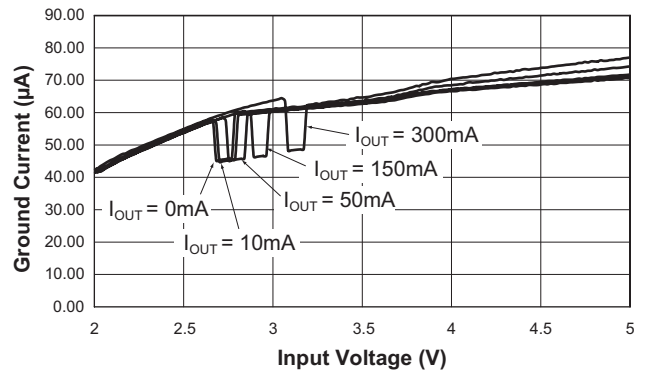

Quiescent Current vs. Temperature

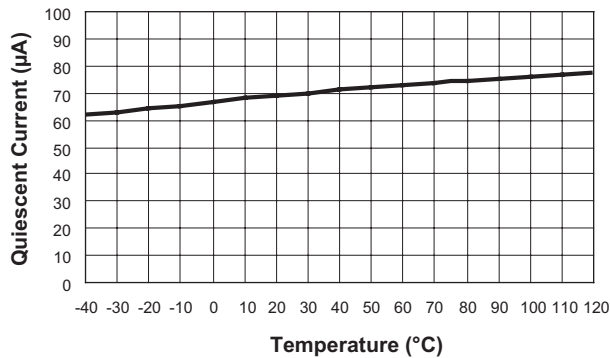

Output Voltage vs. Temperature

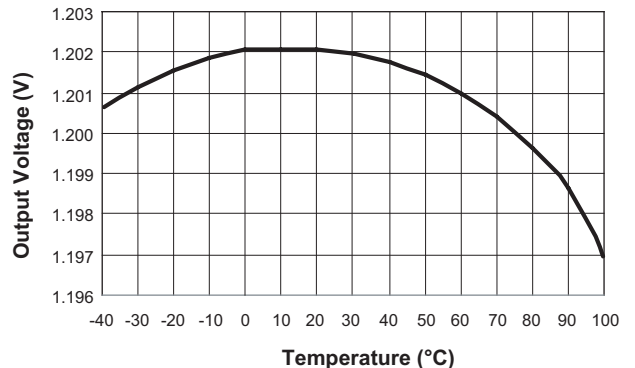

AAT3237

300mA MicroPower™ LDO with PowerOK

Typical Characteristics

Unless otherwise noted, $V_{IN} = 5V$, $T_A = 25^\circ C$.

Turn-On Time and POK Delay

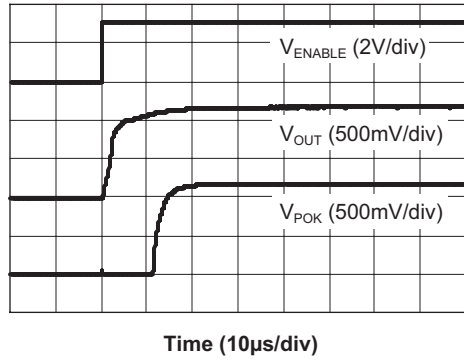

Line Transient Response

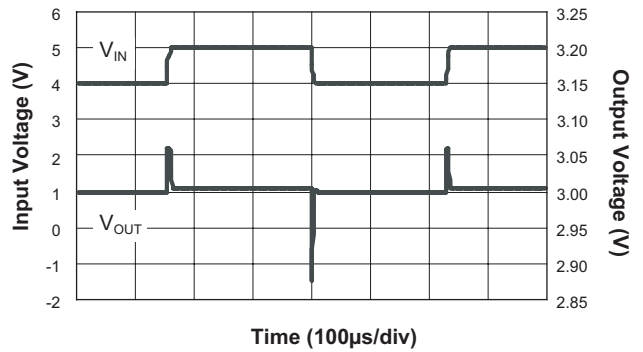

Load Transient Response

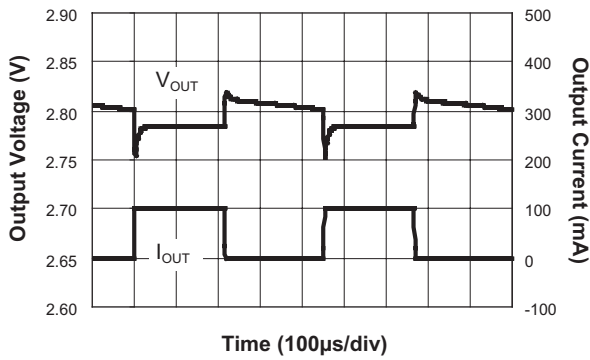

Load Transient Response 300mA

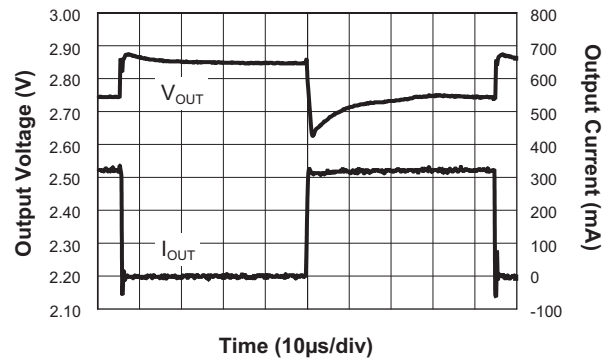

Over-Current Protection

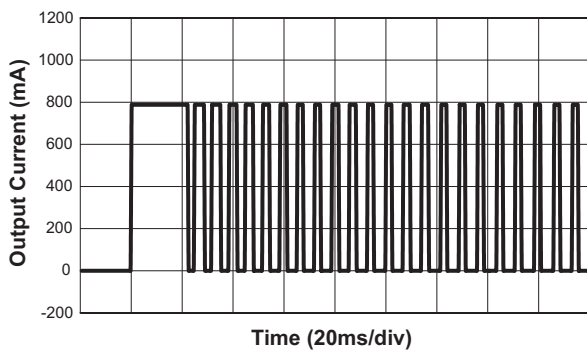

AAT3237 Self Noise

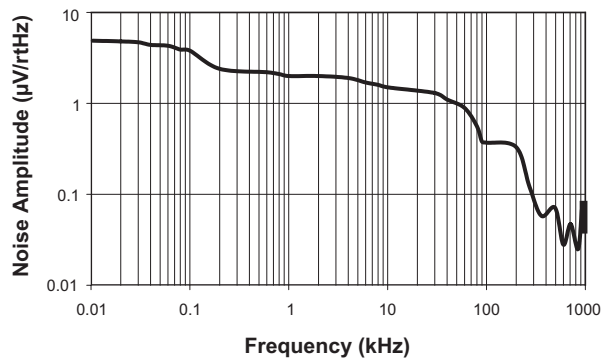

Typical Characteristics

Unless otherwise noted, $V_{IN} = 5V$, $T_A = 25^\circ C$.

$V_{EN(H)}$ and $V_{EN(L)}$ vs. V_{IN}

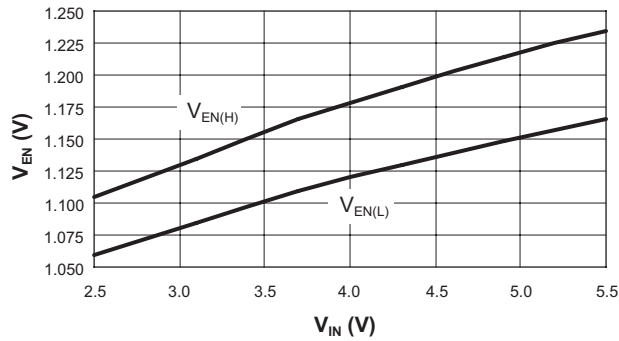

Applications Information

To assure the maximum possible performance is obtained from the AAT3237, please refer to the following application recommendations.

Input Capacitor

Typically, a 1 μ F or larger capacitor is recommended for C_{IN} in most applications. A C_{IN} capacitor is not required for basic LDO regulator operation. However, if the AAT3237 is physically located more than three centimeters from an input power source, a C_{IN} capacitor will be needed for stable operation. C_{IN} should be located as closely to the device V_{IN} pin as practically possible. C_{IN} values greater than 1 μ F will offer superior input line transient response and will assist in maximizing the highest possible power supply ripple rejection.

Ceramic, tantalum, or aluminum electrolytic capacitors may be selected for C_{IN} . There is no specific capacitor ESR requirement for C_{IN} . However, for 300mA LDO regulator output operation, ceramic capacitors are recommended for C_{IN} due to their inherent capability over tantalum capacitors to withstand input current surges from low impedance sources such as batteries in portable devices.

Output Capacitor

For proper load voltage regulation and operational stability, a capacitor is required between pins V_{OUT} and GND. The C_{OUT} capacitor connection to the LDO regulator ground pin should be made as direct as practically possible for maximum device performance.

The AAT3237 has been specifically designed to function with very low ESR ceramic capacitors. For best performance, ceramic capacitors are recommended.

Typical output capacitor values for maximum output current conditions range from 1 μ F to 10 μ F. Applications utilizing the exceptionally low output noise and optimum power supply ripple rejection characteristics of the AAT3237 should use 2.2 μ F or greater for C_{OUT} . If desired, C_{OUT} may be increased without limit.

In low output current applications where output load is less than 10mA, the minimum value for C_{OUT} can be as low as 0.47 μ F.

Capacitor Characteristics

Ceramic composition capacitors are highly recommended over all other types of capacitors for use with the AAT3237. Ceramic capacitors offer many advantages over their tantalum and aluminum electrolytic counterparts. A ceramic capacitor typically has very low ESR, is lower cost, has a smaller PCB footprint, and is non-polarized. Line and load transient response of the LDO regulator is improved by using low ESR ceramic capacitors. Since ceramic capacitors are non-polarized, they are not prone to incorrect connection damage.

Equivalent Series Resistance: ESR is a very important characteristic to consider when selecting a capacitor. ESR is the internal series resistance associated with a capacitor that includes lead resistance, internal connections, size and area, material composition, and ambient temperature. Typically, capacitor ESR is measured in milliohms for ceramic capacitors and can range to more than several ohms for tantalum or aluminum electrolytic capacitors.

Ceramic Capacitor Materials: Ceramic capacitors less than 0.1 μ F are typically made from NPO or C0G materials. NPO and C0G materials generally have tight tolerance and are very stable over temperature. Larger capacitor values are usually composed of X7R, X5R, Z5U, or Y5V dielectric materials. These two material types are not recommended for use with LDO regulators since the capacitor tolerance can vary more than $\pm 50\%$ over the operating temperature range of the device. A 2.2 μ F Y5V capacitor could be reduced to 1 μ F over temperature; this could cause problems for circuit operation. X7R and X5R dielectrics are much more desirable. The temperature tolerance of X7R dielectric is better than $\pm 15\%$.

Capacitor area is another contributor to ESR. Capacitors that are physically large in size will have a lower ESR when compared to a smaller sized capacitor of an equivalent material and capacitance value. These larger devices can improve circuit transient response when compared to an equal value capacitor in a smaller package size.

Consult capacitor vendor datasheets carefully when selecting capacitors for LDO regulators.

AAT3237

300mA MicroPower™ LDO with PowerOK

POK Output

The AAT3237 features an integrated Power-OK comparator which can be used as an error flag. The POK open-drain output goes low when OUT is 6% below its nominal regulation voltage. Connect a pull-up resistor from POK to OUT.

Enable Function

The AAT3237 features an LDO regulator enable/disable function. This pin (EN) is active high and is compatible with CMOS logic. To assure the LDO regulator will switch on, the EN turn-on control level must be greater than 2.0V. The LDO regulator will go into the disable shutdown mode when the voltage on the EN pin falls below 0.6V. If the enable function is not needed in a specific application, it may be tied to V_{IN} to keep the LDO regulator in a continuously on state.

When the LDO regulator is in shutdown mode, an internal 1.5k Ω resistor is connected between V_{OUT} and GND. This is intended to discharge C_{OUT} when the LDO regulator is disabled. The internal 1.5k Ω has no adverse effect on device turn-on time.

Short-Circuit Protection

The AAT3237 contains an internal short-circuit protection circuit that will trigger when the output load current exceeds the internal threshold limit. Under short-circuit conditions, the output of the LDO regulator will be current limited until the short-circuit condition is removed from the output or LDO regulator package power dissipation exceeds the device thermal limit.

Thermal Protection

The AAT3237 has an internal thermal protection circuit which will turn on when the device die temperature exceeds 145°C. The internal thermal protection circuit will actively turn off the LDO regulator output pass device to prevent the possibility of over-temperature damage. The LDO regulator output will remain in a shutdown state until the internal die temperature falls back below the 145°C trip point.

The combination and interaction between the short-circuit and thermal protection systems allows the LDO regulator to withstand indefinite short-circuit conditions without sustaining permanent damage.

No-Load Stability

The AAT3237 is designed to maintain output voltage regulation and stability under operational no-load conditions. This is an important characteristic for applications where the output current may drop to zero.

Reverse Output-to-Input Voltage Conditions and Protection

Under normal operating conditions, a parasitic diode exists between the output and input of the LDO regulator. The input voltage should always remain greater than the output load voltage, maintaining a reverse bias on the internal parasitic diode. Conditions where V_{OUT} might exceed V_{IN} should be avoided since this would forward bias the internal parasitic diode and allow excessive current flow into the V_{OUT} pin, possibly damaging the LDO regulator.

In applications where there is a possibility of V_{OUT} exceeding V_{IN} for brief amounts of time during normal operation, the use of a larger value C_{IN} capacitor is highly recommended. A larger value of C_{IN} with respect to C_{OUT} will effect a slower C_{IN} decay rate during shutdown, thus preventing V_{OUT} from exceeding V_{IN} . In applications where there is a greater danger of V_{OUT} exceeding V_{IN} for extended periods of time, it is recommended to place a Schottky diode across V_{IN} to V_{OUT} (connecting the cathode to V_{IN} and anode to V_{OUT}). The Schottky diode forward voltage should be less than 0.45V.

AAT3237

300mA MicroPower™ LDO with PowerOK

Ordering Information

Output Voltage	Package	Marking ¹	Part Number (Tape and Reel) ²
1.2V	SOT23-6		AAT3237IGU-1.2-T1
1.5V	SOT23-6		AAT3237IGU-1.5-T1
1.8V	SOT23-6		AAT3237IGU-1.8-T1
2.0V	SOT23-6		AAT3237IGU-2.0-T1
2.3V	SOT23-6		AAT3237IGU-2.3-T1
2.5V	SOT23-6		AAT3237IGU-2.5-T1
2.7V	SOT23-6		AAT3237IGU-2.7-T1
3.3V	SOT23-6	HRXYY	AAT3237IGU-3.3-T1
3.5V	SOT23-6		AAT3237IGU-3.5-T1
1.2V	SC70JW-8		AAT3237IJS-1.2-T1
1.5V	SC70JW-8		AAT3237IJS-1.5-T1
1.8V	SC70JW-8		AAT3237IJS-1.8-T1
2.0V	SC70JW-8		AAT3237IJS-2.0-T1
2.3V	SC70JW-8		AAT3237IJS-2.3-T1
2.5V	SC70JW-8		AAT3237IJS-2.5-T1
2.7V	SC70JW-8		AAT3237IJS-2.7-T1
2.8V	SC70JW-8		AAT3237IJS-2.8-T1
2.85V	SC70JW-8		AAT3237IJS-2.85-T1
2.9V	SC70JW-8		AAT3237IJS-2.9-T1
3.0V	SC70JW-8		AAT3237IJS-3.0-T1
3.3V	SC70JW-8		AAT3237IJS-3.3-T1
3.5V	SC70JW-8		AAT3237IJS-3.5-T1



Skyworks Green™ products are compliant with all applicable legislation and are halogen-free.

For additional information, refer to *Skyworks Definition of Green™*, document number SQ04-0074.

1. XYY = assembly and date code.

2. Sample stock is generally held on all part numbers listed in **BOLD**.

Package Information

SOT23-6

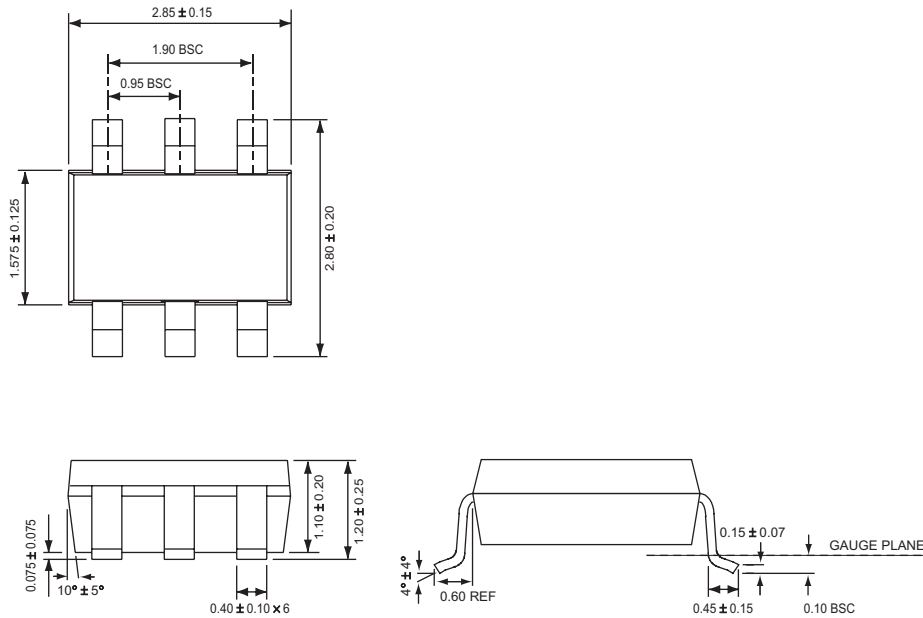

SC70JW-8

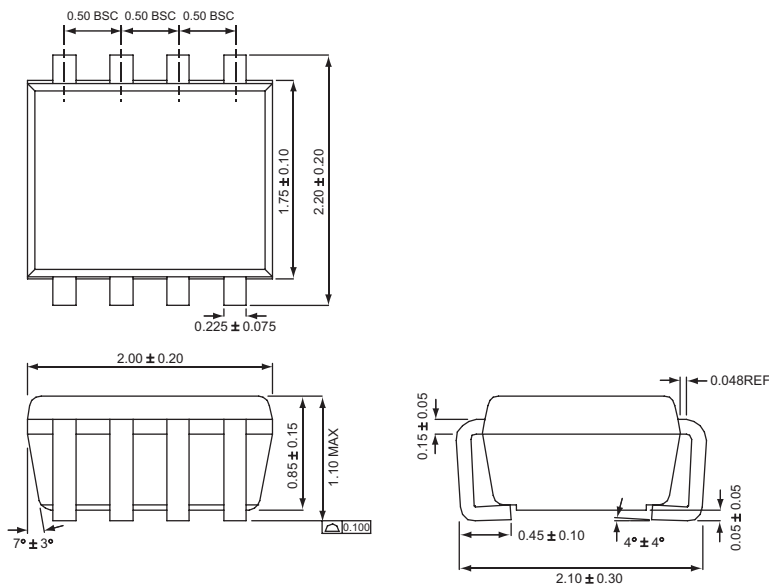

All dimensions in millimeters.

Copyright © 2012 Skyworks Solutions, Inc. All Rights Reserved.

Information in this document is provided in connection with Skyworks Solutions, Inc. ("Skyworks") products or services. These materials, including the information contained herein, are provided by Skyworks as a service to its customers and may be used for informational purposes only by the customer. Skyworks assumes no responsibility for errors or omissions in these materials or the information contained herein. Skyworks may change its documentation, products, services, specifications or product descriptions at any time, without notice. Skyworks makes no commitment to update the materials or information and shall have no responsibility whatsoever for conflicts, incompatibilities, or other difficulties arising from any future changes.

No license, whether express, implied, by estoppel or otherwise, is granted to any intellectual property rights by this document. Skyworks assumes no liability for any materials, products or information provided hereunder, including the sale, distribution, reproduction or use of Skyworks products, information or materials, except as may be provided in Skyworks Terms and Conditions of Sale.

THE MATERIALS, PRODUCTS AND INFORMATION ARE PROVIDED "AS IS" WITHOUT WARRANTY OF ANY KIND, WHETHER EXPRESS, IMPLIED, STATUTORY, OR OTHERWISE, INCLUDING FITNESS FOR A PARTICULAR PURPOSE OR USE, MERCHANTABILITY, PERFORMANCE, QUALITY OR NON-INFRINGEMENT OF ANY INTELLECTUAL PROPERTY RIGHT; ALL SUCH WARRANTIES ARE HEREBY EXPRESSLY DISCLAIMED. SKYWORKS DOES NOT WARRANT THE ACCURACY OR COMPLETENESS OF THE INFORMATION, TEXT, GRAPHICS OR OTHER ITEMS CONTAINED WITHIN THESE MATERIALS. SKYWORKS SHALL NOT BE LIABLE FOR ANY DAMAGES, INCLUDING BUT NOT LIMITED TO ANY SPECIAL, INDIRECT, INCIDENTAL, STATUTORY, OR CONSEQUENTIAL DAMAGES, INCLUDING WITHOUT LIMITATION, LOST REVENUES OR LOST PROFITS THAT MAY RESULT FROM THE USE OF THE MATERIALS OR INFORMATION, WHETHER OR NOT THE RECIPIENT OF MATERIALS HAS BEEN ADVISED OF THE POSSIBILITY OF SUCH DAMAGE.



Skyworks products are not intended for use in medical, lifesaving or life-sustaining applications, or other equipment in which the failure of the Skyworks products could lead to personal injury, death, physical or environmental damage. Skyworks customers using or selling Skyworks products for use in such applications do so at their own risk and agree to fully indemnify Skyworks for any damages resulting from such improper use or sale.

Customers are responsible for their products and applications using Skyworks products, which may deviate from published specifications as a result of design defects, errors, or operation of products outside of published parameters or design specifications. Customers should include design and operating safeguards to minimize these and other risks. Skyworks assumes no liability for applications assistance, customer product design, or damage to any equipment resulting from the use of Skyworks products outside of stated published specifications or parameters.

Skyworks, the Skyworks symbol, and "Breakthrough Simplicity" are trademarks or registered trademarks of Skyworks Solutions, Inc., in the United States and other countries. Third-party brands and names are for identification purposes only, and are the property of their respective owners. Additional information, including relevant terms and conditions, posted at www.skyworksinc.com, are incorporated by reference.

Looking for pricing, stock, or lifecycle information?

Click below to explore more details on WIN SOURCE:

-  [View AAT3237IGU-3.3-T1 on WIN SOURCE](#)
-  [Skyworks Solutions Inc. Information](#)

Optimize Your Supply Chain with WIN SOURCE Solutions

-  Global Sourcing Solution
-  Obsolete Management
-  Cost Control Management
-  Shortage Management
-  Alternative Solution
-  Excess Inventory Management