



**THE DATASHEET OF  
XC9235A18DMRN**



## 600mA Driver Tr. Built-In, Synchronous Step-Down DC/DC Converters

## ■ GENERAL DESCRIPTION

☆GreenOperation Compatible

The XC9235/XC9236/XC9237 series is a group of synchronous-rectification type DC/DC converters with a built-in 0.42Ω P-channel MOS driver transistor and 0.52Ω N-channel MOS switching transistor, designed to allow the use of ceramic capacitors. Operating voltage range is from 2.0V to 6.0V (A~C types), 1.8V to 6.0V (D~G types). For the D/F types which have a reference voltage of 0.8V (accuracy: ±2.0%), the output voltage can be set from 0.9V by using two external resistors. The A/B/C/E/G types have a fixed output voltage from 0.8V to 4.0V in increments of 0.05V (accuracy: ±2.0%). The device provides a high efficiency, stable power supply with an output current of 600mA to be configured using only a coil and two capacitors connected externally. With the built-in oscillator, either 1.2MHz or 3.0MHz can be selected for suiting to your particular application. As for operation mode, the XC9235 series is PWM control, the XC9236 series is automatic PWM/PFM switching control and the XC9237 series can be manually switched between the PWM control mode and the automatic PWM/PFM switching control mode, allowing fast response, low ripple and high efficiency over the full range of loads (from light load to heavy load).

The soft start and current control functions are internally optimized. During stand-by, all circuits are shutdown to reduce current consumption to as low as 1.0μA or less. The B/F/G types have a high speed soft-start as fast as 0.25ms in typical for quick turn-on. With the built-in UVLO (Under Voltage Lock Out) function, the internal P-channel MOS driver transistor is forced OFF when input voltage becomes 1.4V or lower.

The B to G types integrate  $C_L$  discharge function which enables the electric charge at the output capacitor  $C_L$  to be discharged via the internal discharge switch located between the  $L_x$  and  $V_{SS}$  pins. When the devices enter stand-by mode, output voltage quickly returns to the  $V_{SS}$  level as a result of this function.

Four types of package SOT-25, USP-6C, USP-6EL and WLP-5-03 are available.

## ■ APPLICATIONS

- Smart phones / Mobile phones
- Bluetooth
- Mobile devices / terminals
- Portable game consoles
- Digital still cameras / Camcorders
- Note PCs / Tablet PCs

## ■ FEATURES

Driver Transistor Built-In	: 0.42Ω P-ch driver transistor 0.52Ω N-ch switch transistor
Input Voltage	: 2.0V ~ 6.0V (A/B/C types) 1.8V ~ 6.0V (D/E/F/G types)
Output Voltage	: 0.8V ~ 4.0V (Internally set) 0.9V ~ 6.0V (Externally set)
High Efficiency	: 92% (TYP.)*
Output Current	: 600mA
Oscillation Frequency	: 1.2MHz, 3.0MHz (±15%)
Maximum Duty Cycle	: 100%
Control Methods	: PWM (XC9235) PWM/PFM Auto (XC9236) PWM/PFM Manual (XC9237)
Function	: Current Limiter Circuit Built-In (Constant Current & Latching) $C_L$ Discharge (B/C/D/E/F/G types) High Speed Soft Start (B/F/G type)
Capacitor	: Low ESR Ceramic Capacitor
Operating Ambient Temperature	: -40°C ~ +85°C
Packages	: SOT-25 (A/B/C types only) USP-6C USP-6EL (A/B/C/G types only) WLP-5-03 (A/B types only)
Environmentally Friendly	: EU RoHS Compliant, Pb Free
* Performance depends on external components and wiring on the PCB.	

## ■ TYPICAL APPLICATION CIRCUIT

## ● XC9235/XC9236/XC9237

A/B/C/E/G types (Output Voltage Fixed)

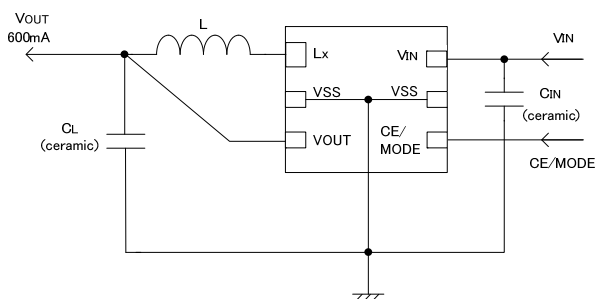

## ● XC9235/XC9236/XC9237

D/F types (Output Voltage Externally Set)

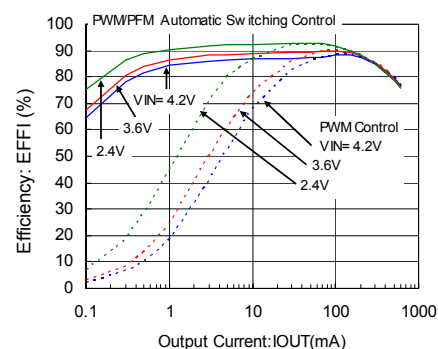

## ■ TYPICAL PERFORMANCE CHARACTERISTICS

● Efficiency vs. Output Current ( $f_{osc}=1.2\text{MHz}$ ,  $V_{OUT}=1.8\text{V}$ )

## PIN CONFIGURATION

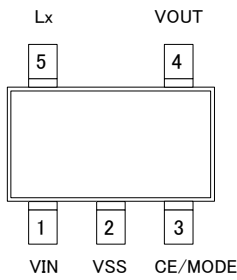

SOT-25  
(TOP VIEW)

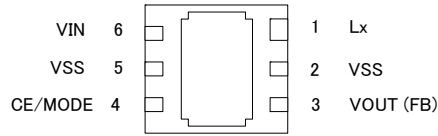

USP-6C  
(BOTTOM VIEW)

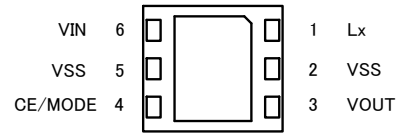

USP-6EL  
(BOTTOM VIEW)

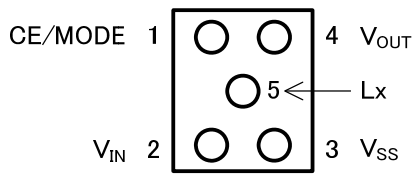

WLP-5-03  
(BOTTOM VIEW)

\* Please short the  $V_{SS}$  pin (No. 2 and 5).

\* The dissipation pad for the USP-6C/USP-6EL packages should be solder-plated in recommended mount pattern and metal masking so as to enhance mounting strength and heat release. We recommend keeping the dissipation pas electrically isolated from the other Pins. If the pad needs to be connected to other pins, it should be connected to the  $V_{SS}$  (No. 5) pin.

## PIN ASSIGNMENT

PIN NUMBER			PIN NAME	FUNCTIONS
SOT-25	USP-6C/USP-6EL	WLP-5-03		
1	6	2	$V_{IN}$	Power Input
2	2, 5	3	$V_{SS}$	Ground
3	4	1	CE / MODE	High Active Enable / Mode Selection Pin
4	3	4	$V_{OUT}$ FB	Fixed Output Voltage Pin (A/B/C/E/G types) Output Voltage Sense Pin (D/F types)
5	1	5	Lx	Switching Output

## ■ PRODUCT CLASSIFICATION

### ● Ordering Information

XC9235①②③④⑤⑥-⑦<sup>(\*)1</sup>

Fixed PWM control

XC9236①②③④⑤⑥-⑦<sup>(\*)1</sup>

PWM / PFM automatic switching control

XC9237①②③④⑤⑥-⑦<sup>(\*)1</sup>

Fixed PWM control ⇔ PWM / PFM automatic switching manual selection

DESIGNATOR	ITEM	SYMBOL	DESCRIPTION
①	Fixed Output voltage (V <sub>OUT</sub> ) Functional selection	A	V <sub>IN</sub> ≥ 2.0V, No C <sub>L</sub> discharge, Low speed soft-start
		B	V <sub>IN</sub> ≥ 2.0V, C <sub>L</sub> discharge, High speed soft-start
		C	V <sub>IN</sub> ≥ 2.0V, C <sub>L</sub> discharge, Low speed soft-start
		E	V <sub>IN</sub> ≥ 1.8V, C <sub>L</sub> discharge, Low speed soft-start
		G	V <sub>IN</sub> ≥ 1.8V, C <sub>L</sub> discharge, High speed soft-start
	Adjustable Output voltage (FB) Functional selection	D	V <sub>IN</sub> ≥ 1.8V, C <sub>L</sub> discharge, Low speed soft-start
F		V <sub>IN</sub> ≥ 1.8V, C <sub>L</sub> discharge, High speed soft-start	
②③	Fixed Output Voltage (V <sub>OUT</sub> )	08 ~ 40	Output voltage options e.g. V <sub>OUT</sub> =2.8V → ②=2, ③=8 V <sub>OUT</sub> =2.85V → ②=2, ③=L 0.05V increments: 0.05=A, 0.15=B, 0.25=C, 0.35=D, 0.45=E, 0.55=F, 0.65=H, 0.75=K, 0.85=L, 0.95=M
	Adjustable Output Voltage (FB)	08	Reference voltage is fixed in 0.8V ②=0, ③=8
④	Oscillation Frequency	C	1.2MHz
		D	3.0MHz
⑤⑥-⑦	Packages (Order Unit)	MR	SOT-25 <sup>(*)2</sup> (3,000pcs/Reel)
		MR-G	SOT-25 <sup>(*)2</sup> (3,000pcs/Reel)
		ER	USP-6C (3,000pcs/Reel)
		ER-G	USP-6C (3,000pcs/Reel)
		4R-G	USP-6EL <sup>(*)4</sup> (3,000pcs/Reel)
		0R-G	WLP-5-03 <sup>(*)3</sup> (3,000pcs/Reel)

<sup>(\*)1</sup> The “-G” suffix denotes Halogen and Antimony free as well as being fully EU RoHS compliant.

<sup>(\*)2</sup> SOT-25-package are available for the A/B/C series only.

<sup>(\*)3</sup> WLP-5-03 package is available for the A/B series only.

<sup>(\*)4</sup> USP-6EL package are available for the A/B/C/G series only.

## FUNCTION

CE/MODE	OPERATIONAL STATES	
	XC9235	XC9236
H Level	Synchronous PWM Fixed Control	Synchronous PWM/PFM Automatic Switching
L Level	Stand-by	Stand-by

CE/MODE	OPERATIONAL STATES
	XC9237
H Level <sup>(*)2</sup>	Synchronous PWM/PFM Automatic Switching
M Level <sup>(*)2</sup>	Synchronous PWM Fixed Control
L Level <sup>(*)2</sup>	Stand-by

(\*1) Please do not leave the CE/MODE pin open.

(\*2) XC9237 series CE/MODE pin voltage level range

H Level :  $V_{IN} - 0.25V \leq H \text{ Level} \leq 6.0V$

M Level :  $0.65V \leq M \text{ Level} \leq V_{IN} - 1.0V$

L Level :  $0V \leq L \text{ Level} \leq 0.25V$

## BLOCK DIAGRAM

●XC9235 / XC9236 / XC9237 A Series



●XC9235 / XC9236 / XC9237 B/C/E/G



●XC9235 / XC9236 / XC9237 D/F Series



NOTE: The signal from CE/MODE Control Logic to PWM/PFM Selector is being fixed to "L" level inside, and XC9235 series chooses only PWM control.

The signal from CE/MODE Control Logic to PWM/PFM Selector is being fixed to "H" level inside, and XC9236 series chooses only PWM/PFM automatic switching control.

Diodes inside the circuit are ESD protection diodes and parasitic diodes.

## ABSOLUTE MAXIMUM RATINGS

Ta=25°C

PARAMETER	SYMBOL	RATINGS	UNIT
V <sub>IN</sub> Pin Voltage	V <sub>IN</sub>	- 0.3 ~ 6.5	V
Lx Pin Voltage	V <sub>LX</sub>	- 0.3 ~ V <sub>IN</sub> + 0.3	V
V <sub>OUT</sub> Pin Voltage	V <sub>OUT</sub>	- 0.3 ~ 6.5	V
FB Pin Voltage	V <sub>FB</sub>	- 0.3 ~ 6.5	V
CE / MODE Pin Voltage	V <sub>CE/MODE</sub>	- 0.3 ~ 6.5	V
Lx Pin Current	I <sub>LX</sub>	±1500	mA
Power Dissipation	SOT-25	250	mW
	USP-6C	120	
	USP-6EL	120	
	WLP-5-03	750	
Operating Ambient Temperature	T <sub>opr</sub>	- 40 ~ + 85	°C
Storage Temperature	T <sub>stg</sub>	- 55 ~ + 125	°C

## ELECTRICAL CHARACTERISTICS

XC9235A18Cxx/XC9236A18Cxx/XC9237A18Cxx,  $V_{OUT}=1.8V$ ,  $f_{OSC}=1.2MHz$ ,  $T_a=25^{\circ}C$

PARAMETER	SYMBOL	CONDITIONS	MIN.	TYP.	MAX.	UNIT	CIRCUIT
Output Voltage	$V_{OUT}$	When connected to external components, $V_{IN}=V_{CE}=5.0V$ , $I_{OUT}=30mA$	1.764	1.800	1.836	V	①
Operating Voltage Range	$V_{IN}$		2.0	-	6.0	V	①
Maximum Output Current	$I_{OUTMAX}$	$V_{IN}=V_{OUT(E)}+2.0V$ , $V_{CE}=1.0V$ , When connected to external components <sup>(9)</sup>	600	-	-	mA	①
UVLO Voltage	$V_{UVLO}$	$V_{CE}=V_{IN}$ , $V_{OUT}=0V$ , Voltage which Lx pin holding "L" level <sup>(1, *11)</sup>	1.00	1.40	1.78	V	③
Supply Current	$I_{DD}$	$V_{IN}=V_{CE}=5.0V$ , $V_{OUT}=V_{OUT(E)} \times 1.1V$	-	15	33	$\mu A$	②
Stand-by Current	$I_{STB}$	$V_{IN}=5.0V$ , $V_{CE}=0V$ , $V_{OUT}=V_{OUT(E)} \times 1.1V$	-	0	1.0	$\mu A$	②
Oscillation Frequency	$f_{OSC}$	When connected to external components, $V_{IN}=V_{OUT(E)}+2.0V$ , $V_{CE}=1.0V$ , $I_{OUT}=100mA$	1020	1200	1380	kHz	①
PFM Switching Current	$I_{PFM}$	When connected to external components, $V_{IN}=V_{OUT(E)}+2.0V$ , $V_{CE}=V_{IN}$ , $I_{OUT}=1mA$ <sup>(12)</sup>	120	160	200	mA	①
PFM Duty Limit	$DTY_{LIMIT\_PFM}$	$V_{CE}=V_{IN}=(C-1)$ , $I_{OUT}=1mA$ <sup>(12)</sup>		200	300	%	①
Maximum Duty Cycle	$D_{MAX}$	$V_{IN}=V_{CE}=5.0V$ , $V_{OUT}=V_{OUT(E)} \times 0.9V$	100	-	-	%	③
Minimum Duty Cycle	$D_{MIN}$	$V_{IN}=V_{CE}=5.0V$ , $V_{OUT}=V_{OUT(E)} \times 1.1V$	-	-	0	%	③
Efficiency <sup>(2)</sup>	EFFI	When connected to external components, $V_{CE}=V_{IN}=V_{OUT(E)}+1.2V$ , $I_{OUT}=100mA$	-	92	-	%	①
Lx SW "H" ON Resistance 1	$R_{LxH}$	$V_{IN}=V_{CE}=5.0V$ , $V_{OUT}=0V$ , $I_{Lx}=100mA$ <sup>(3)</sup>	-	0.35	0.55	$\Omega$	④
Lx SW "H" ON Resistance 2	$R_{LxH}$	$V_{IN}=V_{CE}=3.6V$ , $V_{OUT}=0V$ , $I_{Lx}=100mA$ <sup>(3)</sup>	-	0.42	0.67	$\Omega$	④
Lx SW "L" ON Resistance 1	$R_{LxL}$	$V_{IN}=V_{CE}=5.0V$ <sup>(4)</sup>	-	0.45	0.65	$\Omega$	④
Lx SW "L" ON Resistance 2	$R_{LxL}$	$V_{IN}=V_{CE}=3.6V$ <sup>(4)</sup>	-	0.52	0.77	$\Omega$	-
Lx SW "H" Leak Current <sup>(5)</sup>	$I_{LEAKH}$	$V_{IN}=V_{OUT}=5.0V$ , $V_{CE}=0V$ , $Lx=0V$	-	0.01	1.0	$\mu A$	⑤
Lx SW "L" Leak Current <sup>(5)</sup>	$I_{LEAKL}$	$V_{IN}=V_{OUT}=5.0V$ , $V_{CE}=0V$ , $Lx=5.0V$	-	0.01	1.0	$\mu A$	⑤
Current Limit <sup>(10)</sup>	$I_{LIM}$	$V_{IN}=V_{CE}=5.0V$ , $V_{OUT}=V_{OUT(E)} \times 0.9V$ <sup>(8)</sup>	900	1050	1350	mA	⑥
Output Voltage Temperature Characteristics	$\frac{\Delta V_{OUT}}{(V_{OUT} \cdot \Delta Topr)}$	$I_{OUT}=30mA$ , $-40^{\circ}C \leq Topr \leq 85^{\circ}C$	-	$\pm 100$	-	ppm/ $^{\circ}C$	①
CE "H" Voltage	$V_{CEH}$	$V_{OUT}=0V$ , Applied voltage to $V_{CE}$ , Voltage changes Lx to "H" level <sup>(11)</sup>	0.65	-	6.0	V	③
CE "L" Voltage	$V_{CEL}$	$V_{OUT}=0V$ , Applied voltage to $V_{CE}$ , Voltage changes Lx to "L" level <sup>(11)</sup>	$V_{SS}$	-	0.25	V	③
PWM "H" Level Voltage	$V_{PWMH}$	When connected to external components, $I_{OUT}=1mA$ <sup>(6)</sup> , Voltage which oscillation frequency becomes $1020kHz \leq f_{OSC} \leq 1380kHz$ <sup>(13)</sup>	-	-	$V_{IN} - 1.0$	V	①
PWM "L" Level Voltage	$V_{PWML}$	When connected to external components, $I_{OUT}=1mA$ <sup>(6)</sup> , Voltage which oscillation frequency becomes $f_{OSC} < 1020kHz$ <sup>(13)</sup>	$V_{IN} - 0.25$	-	-	V	①
CE "H" Current	$I_{CEH}$	$V_{IN}=V_{CE}=5.0V$ , $V_{OUT}=0V$	- 0.1	-	0.1	$\mu A$	⑤
CE "L" Current	$I_{CEL}$	$V_{IN}=5.0V$ , $V_{CE}=0V$ , $V_{OUT}=0V$	- 0.1	-	0.1	$\mu A$	⑤
Soft Start Time	$t_{SS}$	When connected to external components, $V_{CE}=0V \rightarrow V_{IN}$ , $I_{OUT}=1mA$	0.5	1.0	2.5	ms	①
Latch Time	$t_{LAT}$	$V_{IN}=V_{CE}=5.0V$ , $V_{OUT}=0.8 \times V_{OUT(E)}$ , Short Lx at $1\Omega$ resistance <sup>(7)</sup>	1.0	-	20.0	ms	⑦
Short Protection Threshold Voltage	$V_{SHORT}$	Sweeping $V_{OUT}$ , $V_{IN}=V_{CE}=5.0V$ , Short Lx at $1\Omega$ resistance, $V_{OUT}$ voltage which Lx becomes "L" level within 1ms	0.675	0.900	1.150	V	⑦

Test conditions: Unless otherwise stated,  $V_{IN}=5.0V$ ,  $V_{OUT(E)}$ =Nominal Voltage

NOTE:

- \*1: Including hysteresis operating voltage range.
- \*2:  $EFFI = \{ (\text{output voltage} \times \text{output current}) / (\text{input voltage} \times \text{input current}) \} \times 100$
- \*3: ON resistance ( $\Omega$ ) =  $(V_{IN} - Lx \text{ pin measurement voltage}) / 100mA$
- \*4: R&D value
- \*5: When temperature is high, a current of approximately  $10\mu A$  (maximum) may leak.
- \*6: The CE/MODE pin of the XC9237A series works also as an external switching pin of PWM control and PWM/PFM control. When the IC is in the operation, control is switched to the automatic PWM/PFM switching mode when the CE/MODE pin voltage is equal to or greater than  $V_{IN}$  minus 0.3V, and to the PWM mode when the CE/MODE pin voltage is equal to or lower than  $V_{IN}$  minus 1.0V and equal to or greater than  $V_{CEH}$ .
- \*7: Time until it short-circuits  $V_{OUT}$  with GND via  $1\Omega$  of resistor from an operational state and is set to  $Lx=0V$  from current limit pulse generating.
- \*8: When  $V_{IN}$  is less than 2.4V, limit current may not be reached because voltage falls caused by ON resistance.
- \*9: When the difference between the input and the output is small, some cycles may be skipped completely before current maximizes. If current is further pulled from this state, output voltage will decrease because of P-ch driver ON resistance.
- \*10: Current limit denotes the level of detection at peak of coil current.
- \*11: "H"= $V_{IN}-V_{IN}-1.2V$ , "L"= $+0.1V \sim -0.1V$
- \*12: XC9235 series exclude  $I_{PFM}$  and  $DTY_{LIMIT\_PFM}$  because those are only for the PFM control's functions.
- \*13: XC9235/XC9236 series exclude  $V_{PWMH}$  and  $V_{PWML}$  because those are only for the XC9237 series' functions.

## ELECTRICAL CHARACTERISTICS (Continued)

XC9235A18Dxx/XC9236A18Dxx/XC9237A18Dxx,  $V_{OUT}=1.8V$ ,  $f_{OSC}=3.0MHz$ ,  $T_a=25^{\circ}C$

PARAMETER	SYMBOL	CONDITIONS	MIN.	TYP.	MAX.	UNIT	CIRCUIT
Output Voltage	$V_{OUT}$	When connected to external components, $V_{IN}=V_{CE}=5.0V$ , $I_{OUT}=30mA$	1.764	1.800	1.836	V	①
Operating Voltage Range	$V_{IN}$		2.0	-	6.0	V	①
Maximum Output Current	$I_{OUTMAX}$	$V_{IN}=V_{OUT(E)}+2.0V$ , $V_{CE}=1.0V$ , When connected to external components <sup>(9)</sup>	600	-	-	mA	①
UVLO Voltage	$V_{UVLO}$	$V_{CE}=V_{IN}$ , $V_{OUT}=0V$ , Voltage which Lx pin holding "L" level <sup>(1,11)</sup>	1.00	1.40	1.78	V	③
Supply Current	$I_{DD}$	$V_{IN}=V_{CE}=5.0V$ , $V_{OUT}=V_{OUT(E)} \times 1.1V$	-	21	35	$\mu A$	②
Stand-by Current	$I_{STB}$	$V_{IN}=5.0V$ , $V_{CE}=0V$ , $V_{OUT}=V_{OUT(E)} \times 1.1V$	-	0	1.0	$\mu A$	②
Oscillation Frequency	$f_{OSC}$	When connected to external components, $V_{IN}=V_{OUT(E)}+2.0V$ , $V_{CE}=1.0V$ , $I_{OUT}=100mA$	2550	3000	3450	kHz	①
PFM Switching Current	$I_{PFM}$	When connected to external components, $V_{IN}=V_{OUT(E)}+2.0V$ , $V_{CE}=V_{IN}$ , $I_{OUT}=1mA$ <sup>(12)</sup>	170	220	270	mA	①
PFM Duty Limit	$DTY_{LIMIT\_PFM}$	$V_{CE}=V_{IN}=(C-1)$ , $I_{OUT}=1mA$ <sup>(12)</sup>	-	200	300	%	①
Maximum Duty Cycle	$D_{MAX}$	$V_{IN}=V_{CE}=5.0V$ , $V_{OUT}=V_{OUT(E)} \times 0.9V$	100	-	-	%	③
Minimum Duty Cycle	$D_{MIN}$	$V_{IN}=V_{CE}=5.0V$ , $V_{OUT}=V_{OUT(E)} \times 0.1V$	-	-	0	%	③
Efficiency <sup>(2)</sup>	EFFI	When connected to external components, $V_{CE}=V_{IN}=V_{OUT(E)}+1.2V$ , $I_{OUT}=100mA$	-	86	-	%	①
Lx SW "H" ON Resistance 1	$R_{LXH}$	$V_{IN}=V_{CE}=5.0V$ , $V_{OUT}=0V$ , $I_{LX}=100mA$ <sup>(3)</sup>	-	0.35	0.55	$\Omega$	④
Lx SW "H" ON Resistance 2	$R_{LXH}$	$V_{IN}=V_{CE}=3.6V$ , $V_{OUT}=0V$ , $I_{LX}=100mA$ <sup>(3)</sup>	-	0.42	0.67	$\Omega$	④
Lx SW "L" ON Resistance 1	$R_{LXL}$	$V_{IN}=V_{CE}=5.0V$ <sup>(4)</sup>	-	0.45	0.65	$\Omega$	-
Lx SW "L" ON Resistance 2	$R_{LXL}$	$V_{IN}=V_{CE}=3.6V$ <sup>(4)</sup>	-	0.52	0.77	$\Omega$	-
Lx SW "H" Leak Current <sup>(5)</sup>	$I_{LEAKH}$	$V_{IN}=V_{OUT}=5.0V$ , $V_{CE}=0V$ , $Lx=0V$	-	0.01	1.0	$\mu A$	⑤
Lx SW "L" Leak Current <sup>(5)</sup>	$I_{LEAKL}$	$V_{IN}=V_{OUT}=5.0V$ , $V_{CE}=0V$ , $Lx=5.0V$	-	0.01	1.0	$\mu A$	⑤
Current Limit <sup>(10)</sup>	$I_{LIM}$	$V_{IN}=V_{CE}=5.0V$ , $V_{OUT}=V_{OUT(E)} \times 0.9V$ <sup>(8)</sup>	900	1050	1350	mA	⑥
Output Voltage Temperature Characteristics	$\frac{\Delta V_{OUT}}{V_{OUT} \cdot \Delta T_{opr}}$	$I_{OUT}=30mA$ , $-40^{\circ}C \leq T_{opr} \leq 85^{\circ}C$	-	$\pm 100$	-	ppm/ $^{\circ}C$	①
CE "H" Voltage	$V_{CEH}$	$V_{OUT}=0V$ , Applied voltage to $V_{CE}$ , Voltage changes Lx to "H" level <sup>(11)</sup>	0.65	-	6.0	V	③
CE "L" Voltage	$V_{CEL}$	$V_{OUT}=0V$ , Applied voltage to $V_{CE}$ , Voltage changes Lx to "L" level <sup>(11)</sup>	$V_{SS}$	-	0.25	V	③
PWM "H" Level Voltage	$V_{PWMH}$	When connected to external components, $I_{OUT}=1mA$ <sup>(6)</sup> , Voltage which oscillation frequency becomes $2550kHz \leq f_{OSC} \leq 3450kHz$ <sup>(13)</sup>	-	-	$V_{IN} - 1.0$	V	①
PWM "L" Level Voltage	$V_{PWML}$	When connected to external components, $I_{OUT}=1mA$ <sup>(6)</sup> , Voltage which oscillation frequency becomes $f_{OSC} < 2550kHz$ <sup>(13)</sup>	$V_{IN} - 0.25$	-	-	V	①
CE "H" Current	$I_{CEH}$	$V_{IN}=V_{CE}=5.0V$ , $V_{OUT}=0V$	- 0.1	-	0.1	$\mu A$	⑤
CE "L" Current	$I_{CEL}$	$V_{IN}=5.0V$ , $V_{CE}=0V$ , $V_{OUT}=0V$	- 0.1	-	0.1	$\mu A$	⑤
Soft Start Time	$t_{SS}$	When connected to external components, $V_{CE}=0V \rightarrow V_{IN}$ , $I_{OUT}=1mA$	0.5	0.9	2.5	ms	①
Latch Time	$t_{LAT}$	$V_{IN}=V_{CE}=5.0V$ , $V_{OUT}=0.8 \times V_{OUT(E)}$ , Short Lx at $1 \Omega$ resistance <sup>(7)</sup>	1.0	-	20	ms	⑦
Short Protection Threshold Voltage	$V_{SHORT}$	Sweeping $V_{OUT}$ , $V_{IN}=V_{CE}=5.0V$ , Short Lx at $1 \Omega$ resistance, $V_{OUT}$ voltage which Lx becomes "L" level within 1ms	0.675	0.900	1.150	V	⑦

Test conditions: Unless otherwise stated,  $V_{IN}=5.0V$ ,  $V_{OUT(E)}$ =Nominal Voltage

NOTE:

\*1: Including hysteresis operating voltage range.

\*2:  $EFFI = \{ (\text{output voltage} \times \text{output current}) / (\text{input voltage} \times \text{input current}) \} \times 100$

\*3: ON resistance ( $\Omega$ ) =  $(V_{IN} - Lx \text{ pin measurement voltage}) / 100mA$

\*4: R&D value

\*5: When temperature is high, a current of approximately  $10 \mu A$  (maximum) may leak.

\*6: The CE/MODE pin of the XC9237A series works also as an external switching pin of PWM control and PWM/PFM control. When the IC is in the operation, control is switched to the automatic PWM/PFM switching mode when the CE/MODE pin voltage is equal to or greater than  $V_{IN}$  minus 0.3V, and to the PWM mode when the CE/MODE pin voltage is equal to or lower than  $V_{IN}$  minus 1.0V and equal to or greater than  $V_{CEH}$ .

\*7: Time until it short-circuits  $V_{OUT}$  with GND via  $1 \Omega$  of resistor from an operational state and is set to  $Lx=0V$  from current limit pulse generating.

\*8: When  $V_{IN}$  is less than 2.4V, limit current may not be reached because voltage falls caused by ON resistance.

\*9: When the difference between the input and the output is small, some cycles may be skipped completely before current maximizes. If current is further pulled from this state, output voltage will decrease because of P-ch driver ON resistance.

\*10: Current limit denotes the level of detection at peak of coil current.

\*11: "H"= $V_{IN}-V_{IN}-1.2V$ , "L"= $+0.1V \sim -0.1V$

\*12: XC9235 series exclude  $I_{PFM}$  and  $DTY_{LIMIT\_PFM}$  because those are only for the PFM control's functions.

\*13: XC9235/XC9236 series exclude  $V_{PWMH}$  and  $V_{PWML}$  because those are only for the XC9237 series' functions.

# XC9235/XC9236/XC9237 Series

## ELECTRICAL CHARACTERISTICS (Continued)

XC9235B(C)(E)(G)18Cxx/XC9236B(C)(E)(G)18Cxx/XC9237B(C)(E)(G)18Cxx,  $V_{OUT}=1.8V$ ,  $f_{OSC}=1.2MHz$ ,  $T_a=25^{\circ}C$

PARAMETER	SYMBOL	CONDITIONS	MIN.	TYP.	MAX.	UNIT	CIRCUIT
Output Voltage	$V_{OUT}$	When connected to external components, $V_{IN}=V_{CE}=5.0V$ , $I_{OUT}=30mA$	1.764	1.800	1.836	V	①
Operating Voltage Range (B/C series)	$V_{IN}$		2.0	-	6.0	V	①
Operating Voltage Range (E/G series)			1.8	-	6.0		
Maximum Output Current	$I_{OUTMAX}$	$V_{IN}=V_{OUT(E)}+2.0V$ , $V_{CE}=1.0V$ , When connected to external components <sup>(*9)</sup>	600	-	-	mA	①
UVLO Voltage	$V_{UVLO}$	$V_{CE}=V_{IN}$ , $V_{OUT}=V_{OUT(E)} \times 0.5V$ <sup>(*14)</sup> Voltage which Lx pin holding "L" level <sup>(*1, *11)</sup>	1.00	1.40	1.78	V	③
Supply Current	$I_{DD}$	$V_{IN}=V_{CE}=5.0V$ , $V_{OUT}=V_{OUT(E)} \times 1.1V$	-	15	33	$\mu A$	②
Stand-by Current	$I_{STB}$	$V_{IN}=5.0V$ , $V_{CE}=0V$ , $V_{OUT}=V_{OUT(E)} \times 1.1V$	-	0	1.0	$\mu A$	②
Oscillation Frequency	$f_{OSC}$	When connected to external components, $V_{IN}=V_{OUT(E)}+2.0V$ , $V_{CE}=1.0V$ , $I_{OUT}=100mA$	1020	1200	1380	kHz	①
PFM Switching Current	$I_{PFM}$	When connected to external components, $V_{IN}=V_{OUT(E)}+2.0V$ , $V_{CE}=V_{IN}$ , $I_{OUT}=1mA$ <sup>(*12)</sup>	120	160	200	mA	①
PFM Duty Limit	$DTY_{LIMIT\_PFM}$	$V_{CE}=V_{IN}=(C-1)$ , $I_{OUT}=1mA$ <sup>(*12)</sup>		200	300	%	①
Maximum Duty Cycle	$D_{MAX}$	$V_{IN}=V_{CE}=5.0V$ , $V_{OUT}=V_{OUT(E)} \times 0.9V$	100	-	-	%	③
Minimum Duty Cycle	$D_{MIN}$	$V_{IN}=V_{CE}=5.0V$ , $V_{OUT}=V_{OUT(E)} \times 1.1V$	-	-	0	%	③
Efficiency <sup>(*2)</sup>	EFFI	When connected to external components, $V_{CE}=V_{IN}=V_{OUT(E)}+1.2V$ , $I_{OUT}=100mA$	-	92	-	%	①
Lx SW "H" ON Resistance 1	$R_{LxH}$	$V_{IN}=V_{CE}=5.0V$ , $V_{OUT(E)} \times 0.9V$ , $I_{Lx}=100mA$ <sup>(*3)</sup>	-	0.35	0.55	$\Omega$	④
Lx SW "H" ON Resistance 2	$R_{LxH}$	$V_{IN}=V_{CE}=3.6V$ , $V_{OUT(E)} \times 0.9V$ , $I_{Lx}=100mA$ <sup>(*3)</sup>	-	0.42	0.67	$\Omega$	④
Lx SW "L" ON Resistance 1	$R_{LxL}$	$V_{IN}=V_{CE}=5.0V$ <sup>(*4)</sup>	-	0.45	0.65	$\Omega$	④
Lx SW "L" ON Resistance 2	$R_{LxL}$	$V_{IN}=V_{CE}=3.6V$ <sup>(*4)</sup>	-	0.52	0.77	$\Omega$	-
Lx SW "H" Leak Current <sup>(*5)</sup>	$I_{LEAKH}$	$V_{IN}=V_{OUT}=5.0V$ , $V_{CE}=0V$ , $Lx=0V$	-	0.01	1.0	$\mu A$	⑤
Current Limit <sup>(*10)</sup>	$I_{LIM}$	$V_{IN}=V_{CE}=5.0V$ , $V_{OUT}=V_{OUT(E)} \times 0.9V$ <sup>(*8)</sup>	900	1050	1350	mA	⑥
Output Voltage Temperature Characteristics	$\frac{\Delta V_{OUT}}{V_{OUT} \cdot \Delta Topr}$	$I_{OUT}=30mA$ , $-40^{\circ}C \leq Topr \leq 85^{\circ}C$	-	$\pm 100$	-	ppm/ $^{\circ}C$	①
CE "H" Voltage	$V_{CEH}$	$V_{OUT}=V_{OUT(E)} \times 0.9V$ , Applied voltage to $V_{CE}$ , Voltage changes Lx to "H" level <sup>(*11)</sup>	0.65	-	6.0	V	③
CE "L" Voltage	$V_{CEL}$	$V_{OUT}=V_{OUT(E)} \times 0.9V$ , Applied voltage to $V_{CE}$ , Voltage changes Lx to "L" level <sup>(*11)</sup>	$V_{SS}$	-	0.25	V	③
PWM "H" Level Voltage	$V_{PWMH}$	When connected to external components, $I_{OUT}=1mA$ <sup>(*6)</sup> , Voltage which oscillation frequency becomes $1020kHz \leq f_{OSC} \leq 1380kHz$ <sup>(*13)</sup>	-	-	$V_{IN} - 1.0$	V	①
PWM "L" Level Voltage	$V_{PWML}$	When connected to external components, $I_{OUT}=1mA$ <sup>(*6)</sup> , Voltage which oscillation frequency becomes $f_{OSC} < 1020kHz$ <sup>(*13)</sup>	$V_{IN} - 0.25$	-	-	V	①
CE "H" Current	$I_{CEH}$	$V_{IN}=V_{CE}=5.0V$ , $V_{OUT}=V_{OUT(E)} \times 0.9V$	- 0.1	-	0.1	$\mu A$	⑤
CE "L" Current	$I_{CEL}$	$V_{IN}=5.0V$ , $V_{CE}=0V$ , $V_{OUT}=V_{OUT(E)} \times 0.9V$	- 0.1	-	0.1	$\mu A$	⑤
Soft Start Time (B/G Series)	$t_{SS}$	When connected to external components, $V_{CE}=0V \rightarrow V_{IN}$ , $I_{OUT}=1mA$	-	0.25	0.40	ms	①
Soft Start Time (C/E Series)	$t_{SS}$	When connected to external components, $V_{CE}=0V \rightarrow V_{IN}$ , $I_{OUT}=1mA$	0.5	1.0	2.5	ms	①
Latch Time	$t_{LAT}$	$V_{IN}=V_{CE}=5.0V$ , $V_{OUT}=0.8 \times V_{OUT(E)}$ , Short Lx at $1\Omega$ resistance <sup>(*7)</sup>	1.0	-	20.0	ms	⑦
Short Protection Threshold Voltage (B/C Series)	$V_{SHORT}$	Sweeping $V_{OUT}$ , $V_{IN}=V_{CE}=5.0V$ , Short Lx at $1\Omega$ resistance, $V_{OUT}$ voltage which Lx becomes "L" level within 1ms	0.675	0.900	1.150	V	⑦
Short Protection Threshold Voltage (E/G Series)	$V_{SHORT}$	$V_{IN}=V_{CE}=5.0V$ , The $V_{OUT}$ at Lx="Low" <sup>(*11)</sup> while decreasing $V_{OUT}$ from $V_{OUT(E)} \times 0.4V$	0.338	0.450	0.563	V	⑦
$C_L$ Discharge	$R_{DCHG}$	$V_{IN}=5.0V$ , $Lx=5.0V$ , $V_{CE}=0V$ , $V_{OUT}=open$	200	300	450	$\Omega$	⑧

Test conditions: Unless otherwise stated,  $V_{IN}=5.0V$ ,  $V_{OUT(E)}$ =Nominal Voltage, applied voltage sequence is  $V_{OUT} \rightarrow V_{IN} \rightarrow V_{CE}$

NOTE:

- \*1: Including hysteresis operating voltage range.
- \*2:  $EFFI = \{ (\text{output voltage} \times \text{output current}) / (\text{input voltage} \times \text{input current}) \} \times 100$
- \*3: ON resistance ( $\Omega$ ) =  $(V_{IN} - Lx \text{ pin measurement voltage}) / 100mA$
- \*4: R&D value
- \*5: When temperature is high, a current of approximately  $10 \mu A$  (maximum) may leak.
- \*6: The CE/MODE pin of the XC9237A series works also as an external switching pin of PWM control and PWM/PFM control. When the IC is in the operation, control is switched to the automatic PWM/PFM switching mode when the CE/MODE pin voltage is equal to or greater than  $V_{IN}$  minus 0.3V, and to the PWM mode when the CE/MODE pin voltage is equal to or lower than  $V_{IN}$  minus 1.0V and equal to or greater than  $V_{CEH}$ .
- \*7: Time until it short-circuits  $V_{OUT}$  with GND via  $1\Omega$  of resistor from an operational state and is set to  $Lx=0V$  from current limit pulse generating.
- \*8: When  $V_{IN}$  is less than 2.4V, limit current may not be reached because voltage falls caused by ON resistance.
- \*9: When the difference between the input and the output is small, some cycles may be skipped completely before current maximizes.  
If current is further pulled from this state, output voltage will decrease because of P-ch driver ON resistance.
- \*10: Current limit denotes the level of detection at peak of coil current.
- \*11: "H"= $V_{IN}-V_{IN}-1.2V$ , "L"= $+0.1V \sim -0.1V$
- \*12: XC9235 series exclude  $I_{PFM}$  and  $DTY_{LIMIT\_PFM}$  because those are only for the PFM control's functions.
- \*13: XC9235/XC9236 series exclude  $V_{PWMH}$  and  $V_{PWML}$  because those are only for the XC9237 series' functions.
- \*14:  $V_{IN}$  is applied when  $V_{OUT(E)} \times 0.5V$  becomes more than  $V_{IN}$ .

## ELECTRICAL CHARACTERISTICS (Continued)

XC9235B(C)(E)(G)18Dxx/XC9236B(C)(E)(G)18Dxx/XC9237B(C)(E)(G)18Dxx,  $V_{OUT}=1.8V$ ,  $f_{OSC}=3.0MHz$ ,  $T_a=25^{\circ}C$

PARAMETER	SYMBOL	CONDITIONS	MIN.	TYP.	MAX.	UNIT	CIRCUIT
Output Voltage	$V_{OUT}$	When connected to external components, $V_{IN}=V_{CE}=5.0V$ , $I_{OUT}=30mA$	1.764	1.800	1.836	V	①
Operating Voltage Range (B/C series)	$V_{IN}$		2.0	-	6.0	V	①
Operating Voltage Range (E/G series)			1.8	-	6.0		
Maximum Output Current	$I_{OUTMAX}$	$V_{IN}=V_{OUT(E)}+2.0V$ , $V_{CE}=1.0V$ , When connected to external components <sup>(9)</sup>	600	-	-	mA	①
UVLO Voltage	$V_{UVLO}$	$V_{CE}=V_{IN}$ , $V_{OUT}=V_{OUT(E)} \times 0.5V$ <sup>(14)</sup> , Voltage which Lx pin holding "L" level <sup>(11,11)</sup>	1.00	1.40	1.78	V	③
Supply Current	$I_{DD}$	$V_{IN}=V_{CE}=5.0V$ , $V_{OUT}=V_{OUT(E)} \times 1.1V$	-	21	35	$\mu A$	②
Stand-by Current	$I_{STB}$	$V_{IN}=5.0V$ , $V_{CE}=0V$ , $V_{OUT}=V_{OUT(E)} \times 1.1V$	-	0	1.0	$\mu A$	②
Oscillation Frequency	$f_{OSC}$	When connected to external components, $V_{IN}=V_{OUT(E)}+2.0V$ , $V_{CE}=1.0V$ , $I_{OUT}=100mA$	2550	3000	3450	kHz	①
PFM Switching Current	$I_{PFM}$	When connected to external components, $V_{IN}=V_{OUT(E)}+2.0V$ , $V_{CE}=V_{IN}$ , $I_{OUT}=1mA$ <sup>(12)</sup>	170	220	270	mA	①
PFM Duty Limit	$DTY_{LIMIT\_PFM}$	$V_{CE}=V_{IN}=(C-1)$ , $I_{OUT}=1mA$ <sup>(12)</sup>	-	200	300	%	①
Maximum Duty Cycle	$D_{MAX}$	$V_{IN}=V_{CE}=5.0V$ , $V_{OUT}=V_{OUT(E)} \times 0.9V$	100	-	-	%	③
Minimum Duty Cycle	$D_{MIN}$	$V_{IN}=V_{CE}=5.0V$ , $V_{OUT}=V_{OUT(E)} \times 0.1V$	-	-	0	%	③
Efficiency <sup>(2)</sup>	EFFI	When connected to external components, $V_{CE}=V_{IN}=V_{OUT(E)}+1.2V$ , $I_{OUT}=100mA$	-	86	-	%	①
Lx SW "H" ON Resistance 1	$R_{LXH}$	$V_{IN}=V_{CE}=5.0V$ , $V_{OUT}=V_{OUT(E)} \times 0.9V$ , $I_{LX}=100mA$ <sup>(3)</sup>	-	0.35	0.55	$\Omega$	④
Lx SW "H" ON Resistance 2	$R_{LXH}$	$V_{IN}=V_{CE}=3.6V$ , $V_{OUT}=V_{OUT(E)} \times 0.9V$ , $I_{LX}=100mA$ <sup>(3)</sup>	-	0.42	0.67	$\Omega$	④
Lx SW "L" ON Resistance 1	$R_{LXL}$	$V_{IN}=V_{CE}=5.0V$ <sup>(4)</sup>	-	0.45	0.65	$\Omega$	-
Lx SW "L" ON Resistance 2	$R_{LXL}$	$V_{IN}=V_{CE}=3.6V$ <sup>(4)</sup>	-	0.52	0.77	$\Omega$	-
Lx SW "H" Leak Current <sup>(5)</sup>	$I_{LEAKH}$	$V_{IN}=V_{OUT}=5.0V$ , $V_{CE}=0V$ , $Lx=0V$	-	0.01	1.0	$\mu A$	⑤
Current Limit <sup>(10)</sup>	$I_{LIM}$	$V_{IN}=V_{CE}=5.0V$ , $V_{OUT}=V_{OUT(E)} \times 0.9V$ <sup>(8)</sup>	900	1050	1350	mA	⑥
Output Voltage Temperature Characteristics	$\frac{\Delta V_{OUT}}{V_{OUT} \cdot \Delta T_{opr}}$	$I_{OUT}=30mA$ , $-40^{\circ}C \leq T_{opr} \leq 85^{\circ}C$	-	$\pm 100$	-	ppm/ $^{\circ}C$	①
CE "H" Voltage	$V_{CEH}$	$V_{OUT}=V_{OUT(E)} \times 0.9V$ , Applied voltage to $V_{CE}$ , Voltage changes Lx to "H" level <sup>(11)</sup>	0.65	-	6.0	V	③
CE "L" Voltage	$V_{CEL}$	$V_{OUT}=V_{OUT(E)} \times 0.9V$ , Applied voltage to $V_{CE}$ , Voltage changes Lx to "L" level <sup>(11)</sup>	$V_{SS}$	-	0.25	V	③
PWM "H" Level Voltage	$V_{PWHM}$	When connected to external components, $I_{OUT}=1mA$ <sup>(6)</sup> , Voltage which oscillation frequency becomes $2550kHz \leq f_{OSC} \leq 3450kHz$ <sup>(13)</sup>	-	-	$V_{IN} - 1.0$	V	①
PWM "L" Level Voltage	$V_{PWML}$	When connected to external components, $I_{OUT}=1mA$ <sup>(6)</sup> , Voltage which oscillation frequency becomes $f_{OSC} < 2550kHz$ <sup>(13)</sup>	$V_{IN} - 0.25$	-	-	V	①
CE "H" Current	$I_{CEH}$	$V_{IN}=V_{CE}=5.0V$ , $V_{OUT}=V_{OUT(E)} \times 0.9V$	-0.1	-	0.1	$\mu A$	⑤
CE "L" Current	$I_{CEL}$	$V_{IN}=5.0V$ , $V_{CE}=0V$ , $V_{OUT}=V_{OUT(E)} \times 0.9V$	-0.1	-	0.1	$\mu A$	⑤
Soft Start Time (B/G Series)	$t_{SS}$	When connected to external components, $V_{CE}=0V \rightarrow V_{IN}$ , $I_{OUT}=1mA$	-	0.32	0.50	ms	①
Soft Start Time (C/E Series)	$t_{SS}$	When connected to external components, $V_{CE}=0V \rightarrow V_{IN}$ , $I_{OUT}=1mA$	0.5	0.9	2.5	ms	①
Latch Time	$t_{LAT}$	$V_{IN}=V_{CE}=5.0V$ , $V_{OUT}=0.8 \times V_{OUT(E)}$ , Short Lx at $1\Omega$ resistance <sup>(7)</sup>	1.0	-	20	ms	⑦
Short Protection Threshold Voltage (B/C Series)	$V_{SHORT}$	Sweeping $V_{OUT}$ , $V_{IN}=V_{CE}=5.0V$ , Short Lx at $1\Omega$ resistance, $V_{OUT}$ voltage which Lx becomes "L" level within 1ms	0.675	0.900	1.150	V	⑦
Short Protection Threshold Voltage (E/G Series)	$V_{SHORT}$	$V_{IN}=V_{CE}=5.0V$ , The $V_{OUT}$ at $Lx="Low"$ <sup>(11)</sup> while decreasing $V_{OUT}$ from $V_{OUT(E)} \times 0.4V$	0.338	0.450	0.563	V	⑦
$C_L$ Discharge	$R_{DCHG}$	$V_{IN}=5.0V$ , $Lx=5.0V$ , $V_{CE}=0V$ , $V_{OUT}=open$	200	300	450	$\Omega$	⑧

Test conditions: Unless otherwise stated,  $V_{IN}=5.0V$ ,  $V_{OUT(E)}$ =Nominal Voltage, applied voltage sequence is  $V_{OUT} \rightarrow V_{IN} \rightarrow V_{CE}$

NOTE:

- \*1: Including hysteresis operating voltage range.
- \*2:  $EFFI = \{ (output\ voltage \times output\ current) / (input\ voltage \times input\ current) \} \times 100$
- \*3: ON resistance ( $\Omega$ ) =  $(V_{IN} - Lx\ pin\ measurement\ voltage) / 100mA$
- \*4: R&D value
- \*5: When temperature is high, a current of approximately  $10\mu A$  (maximum) may leak.
- \*6: The CE/MODE pin of the XC9237A series works also as an external switching pin of PWM control and PWM/PFM control. When the IC is in the operation, control is switched to the automatic PWM/PFM switching mode when the CE/MODE pin voltage is equal to or greater than  $V_{IN}$  minus 0.3V, and to the PWM mode when the CE/MODE pin voltage is equal to or lower than  $V_{IN}$  minus 1.0V and equal to or greater than  $V_{CEH}$ .
- \*7: Time until it short-circuits  $V_{OUT}$  with GND via  $1\Omega$  resistor from an operational state and is set to  $Lx=0V$  from current limit pulse generating.
- \*8: When  $V_{IN}$  is less than 2.4V, limit current may not be reached because voltage falls caused by ON resistance.
- \*9: When the difference between the input and the output is small, some cycles may be skipped completely before current maximizes. If current is further pulled from this state, output voltage will decrease because of P-ch driver ON resistance.
- \*10: Current limit denotes the level of detection at peak of coil current.
- \*11: "H"= $V_{IN}-V_{IN}-1.2V$ , "L"= $+0.1V \sim -0.1V$
- \*12: XC9235 series exclude  $I_{PFM}$  and  $DTY_{LIMIT\_PFM}$  because those are only for the PFM control's functions.
- \*13: XC9235/XC9236 series exclude  $V_{PWHM}$  and  $V_{PWML}$  because those are only for the XC9237 series' functions.
- \*14:  $V_{IN}$  is applied when  $V_{OUT(E)} \times 0.5V$  becomes more than  $V_{IN}$ .

# XC9235/XC9236/XC9237 Series

## ELECTRICAL CHARACTERISTICS (Continued)

XC9235D(F)08Cxx/XC9236D(F)08Cxx/XC9237D(F)08Cxx, FB Type,  $f_{OSC}=1.2\text{MHz}$ ,  $T_a=25^\circ\text{C}$

PARAMETER	SYMBOL	CONDITIONS	MIN.	TYP.	MAX.	UNIT	CIRCUIT
FB Voltage	$V_{FB}$	$V_{IN} = V_{CE} = 5.0\text{V}$ , The $V_{FB}$ at $L_x = \text{"High"}$ <sup>(11)</sup> while decreasing FB pin voltage from 0.9V.	0.784	0.800	0.816	V	③
Operating Voltage Range	$V_{IN}$		1.8	-	6.0	V	①
Maximum Output Current	$I_{OUTMAX}$	$V_{IN}=3.2\text{V}$ , $V_{CE}=1.0\text{V}$ When connected to external components <sup>(9)</sup>	600	-	-	mA	①
UVLO Voltage	$V_{UVLO}$	$V_{CE} = V_{IN}$ , $V_{FB} = 0.4\text{V}$ , Voltage which $L_x$ pin holding "L" level <sup>(11,11)</sup>	1.00	1.40	1.78	V	③
Supply Current	$I_{DD}$	$V_{IN} = V_{CE} = 5.0\text{V}$ , $V_{FB} = 0.88\text{V}$	-	15	-	$\mu\text{A}$	②
Stand-by Current	$I_{STB}$	$V_{IN} = 5.0\text{V}$ , $V_{CE} = 0\text{V}$ , $V_{FB} = 0.88\text{V}$	-	0	1.0	$\mu\text{A}$	②
Oscillation Frequency	$f_{OSC}$	When connected to external components, $V_{IN} = 3.2\text{V}$ , $V_{CE} = 1.0\text{V}$ , $I_{OUT} = 100\text{mA}$	1020	1200	1380	kHz	①
PFM Switching Current	$I_{PFM}$	When connected to external components, $V_{IN} = 3.2\text{V}$ , $V_{CE} = V_{IN}$ , $I_{OUT} = 1\text{mA}$ <sup>(12)</sup>	120	160	200	mA	①
PFM Duty Limit	$DTY_{LIMIT\_PFM}$	$V_{CE} = V_{IN} = 2.0\text{V}$ , $I_{OUT} = 1\text{mA}$ <sup>(12)</sup>	-	200	300	%	①
Maximum Duty Cycle	$D_{MAX}$	$V_{IN} = V_{CE} = 5.0\text{V}$ , $V_{FB} = 0.72\text{V}$	100	-	-	%	③
Minimum Duty Cycle	$D_{MIN}$	$V_{IN} = V_{CE} = 5.0\text{V}$ , $V_{FB} = 0.88\text{V}$	-	-	0	%	③
Efficiency <sup>(2)</sup>	EFFI	When connected to external components, $V_{CE} = V_{IN} = 2.4\text{V}$ , $I_{OUT} = 100\text{mA}$	-	92	-	%	①
Lx SW "H" ON Resistance 1	$R_{LxH}$	$V_{IN} = V_{CE} = 5.0\text{V}$ , $V_{FB} = 0.72\text{V}$ , $I_{Lx} = 100\text{mA}$ <sup>(3)</sup>	-	0.35	0.55	$\Omega$	④
Lx SW "H" ON Resistance 2	$R_{LxH}$	$V_{IN} = V_{CE} = 3.6\text{V}$ , $V_{FB} = 0.72\text{V}$ , $I_{Lx} = 100\text{mA}$ <sup>(3)</sup>	-	0.42	0.67	$\Omega$	④
Lx SW "L" ON Resistance 1	$R_{LxL}$	$V_{IN} = V_{CE} = 5.0\text{V}$ <sup>(4)</sup>	-	0.45	0.65	$\Omega$	-
Lx SW "L" ON Resistance 2	$R_{LxL}$	$V_{IN} = V_{CE} = 3.6\text{V}$ <sup>(4)</sup>	-	0.52	0.77	$\Omega$	-
Lx SW "H" Leak Current <sup>(5)</sup>	$I_{LEAKH}$	$V_{IN} = V_{FB} = 5.0\text{V}$ , $V_{CE} = 0\text{V}$ , $L_x = 0\text{V}$	-	0.01	1.0	$\mu\text{A}$	⑨
Current Limit <sup>(10)</sup>	$I_{LIM}$	$V_{IN} = V_{CE} = 5.0\text{V}$ , $V_{FB} = 0.72\text{V}$ <sup>(8)</sup>	900	1050	1350	mA	⑥
Output Voltage Temperature Characteristics	$\Delta V_{OUT} / (V_{OUT} \cdot \Delta T_{OP})$	$I_{OUT} = 30\text{mA}$ $-40^\circ\text{C} \leq T_{OP} \leq 85^\circ\text{C}$	-	$\pm 100$	-	ppm/°C	①
CE "H" Voltage	$V_{CEH}$	$V_{FB} = 0.72\text{V}$ , Applied voltage to $V_{CE}$ , Voltage changes $L_x$ to "H" level <sup>(11)</sup>	0.65	-	6.0	V	③
CE "L" Voltage	$V_{CEL}$	$V_{FB} = 0.72\text{V}$ , Applied voltage to $V_{CE}$ , Voltage changes $L_x$ to "L" level <sup>(11)</sup>	$V_{SS}$	-	0.25	V	③
PWM "H" Level Voltage	$V_{PWHH}$	When connected to external components, $I_{OUT} = 1\text{mA}$ <sup>(6)</sup> , Voltage which oscillation frequency becomes $1020\text{kHz} \leq f_{OSC} \leq 1380\text{kHz}$ <sup>(13)</sup>	-	-	$V_{IN} - 1.0$	V	①
PWM "L" Level Voltage	$V_{PWML}$	When connected to external components, $I_{OUT} = 1\text{mA}$ <sup>(6)</sup> , Voltage which oscillation frequency becomes $f_{OSC} < 1020\text{kHz}$ <sup>(13)</sup>	$V_{IN} - 0.25$	-	-	V	①
CE "H" Current	$I_{CEH}$	$V_{IN} = V_{CE} = 5.0\text{V}$ , $V_{FB} = 0.72\text{V}$	-0.1	-	0.1	$\mu\text{A}$	⑤
CE "L" Current	$I_{CEL}$	$V_{IN} = 5.0\text{V}$ , $V_{CE} = 0\text{V}$ , $V_{FB} = 0.72\text{V}$	-0.1	-	0.1	$\mu\text{A}$	⑤
Soft Start Time (D series)	$t_{SS}$	When connected to external components, $V_{CE} = 0\text{V} \rightarrow V_{IN}$ , $I_{OUT} = 1\text{mA}$	0.5	1.0	2.5	ms	①
Soft Start Time (F series)			-	0.25	0.40		
Latch Time	$t_{LAT}$	$V_{IN} = V_{CE} = 5.0\text{V}$ , $V_{FB} = 0.64$ , Short $L_x$ at 1 $\Omega$ resistance <sup>(7)</sup>	1.0	-	20.0	ms	⑦
Short Protection Threshold Voltage	$V_{SHORT}$	$V_{IN} = V_{CE} = 5.0\text{V}$ , The $V_{FB}$ at $L_x = \text{"Low"}$ <sup>(11)</sup> while decreasing FB pin voltage from 0.4V.	0.15	0.200	0.25	V	⑦
$C_L$ Discharge	$R_{DCHG}$	$V_{IN} = 5.0\text{V}$ , $L_x = 5.0\text{V}$ , $V_{CE} = 0\text{V}$ , $V_{FB} = \text{open}$	200	300	450	$\Omega$	⑧

Test conditions:  $V_{OUT} = 1.2\text{V}$  when the external components are connected. Unless otherwise stated,  $V_{IN} = 5.0\text{V}$ ,  $V_{OUT(E)} = \text{Nominal Voltage}$ , applied voltage sequence is  $V_{OUT} \rightarrow V_{IN} \rightarrow V_{CE}$

### NOTE:

- \*1: Including hysteresis operating voltage range.
- \*2:  $EFFI = \{ (\text{output voltage} \times \text{output current}) / (\text{input voltage} \times \text{input current}) \} \times 100$
- \*3: ON resistance ( $\Omega$ ) =  $(V_{IN} - L_x \text{ pin measurement voltage}) / 100\text{mA}$
- \*4: R&D value
- \*5: When temperature is high, a current of approximately  $10\mu\text{A}$  (maximum) may leak.
- \*6: The CE/MODE pin of the XC9237A series works also as an external switching pin of PWM control and PWM/PFM control. When the IC is in the operation, control is switched to the automatic PWM/PFM switching mode when the CE/MODE pin voltage is equal to or greater than  $V_{IN}$  minus 0.3V, and to the PWM mode when the CE/MODE pin voltage is equal to or lower than  $V_{IN}$  minus 1.0V and equal to or greater than  $V_{CEH}$ .
- \*7: Time until it short-circuits  $V_{FB}$  with GND via 1  $\Omega$  of resistor from an operational state and is set to  $L_x = 0\text{V}$  from current limit pulse generating.
- \*8: When  $V_{IN}$  is less than 2.4V, limit current may not be reached because voltage falls caused by ON resistance.
- \*9: When the difference between the input and the output is small, some cycles may be skipped completely before current maximizes. If current is further pulled from this state, output voltage will decrease because of P-ch driver ON resistance.
- \*10: Current limit denotes the level of detection at peak of coil current.
- \*11: "H" =  $V_{IN} - V_{IN} - 1.2\text{V}$ , "L" =  $+0.1\text{V} \sim -0.1\text{V}$
- \*12: XC9235 series exclude  $I_{PFM}$  and  $DTY_{LIMIT\_PFM}$  because those are only for the PFM control's functions.
- \*13: XC9235/XC9236 series exclude  $V_{PWHH}$  and  $V_{PWML}$  because those are only for the XC9237 series' functions.

## ELECTRICAL CHARACTERISTICS (Continued)

XC9235D(F)08Dxx/XC9236D(F)08Dxx/XC9237D(F)08Dxx, FB, f<sub>OSC</sub>=3.0MHz, Ta=25°C

PARAMETER	SYMBOL	CONDITIONS	MIN.	TYP.	MAX.	UNIT	CIRCUIT
FB Voltage	V <sub>FB</sub>	V <sub>IN</sub> = V <sub>CE</sub> = 5.0V, The V <sub>FB</sub> at Lx="High" <sup>(**11)</sup> while decreasing FB pin voltage from 0.9V.	0.784	0.800	0.816	V	③
Operating Voltage Range	V <sub>IN</sub>		1.8	-	6.0	V	①
Maximum Output Current	I <sub>OUTMAX</sub>	V <sub>IN</sub> =3.2V, V <sub>CE</sub> =1.0V When connected to external components <sup>(**9)</sup>	600	-	-	mA	①
UVLO Voltage	V <sub>UVLO</sub>	V <sub>CE</sub> = V <sub>IN</sub> , V <sub>FB</sub> = 0.4V, Voltage which Lx pin holding "L" level <sup>(**1, **11)</sup>	1.00	1.40	1.78	V	③
Supply Current	I <sub>DD</sub>	V <sub>IN</sub> = V <sub>CE</sub> = 5.0V, V <sub>FB</sub> = 0.88V	-	21	35	μA	②
Stand-by Current	I <sub>STB</sub>	V <sub>IN</sub> = 5.0V, V <sub>CE</sub> = 0V, V <sub>FB</sub> = 0.88V	-	0	1.0	μA	②
Oscillation Frequency	f <sub>OSC</sub>	When connected to external components, V <sub>IN</sub> = 3.2V, V <sub>CE</sub> = 1.0V, I <sub>OUT</sub> = 100mA	2550	3000	3450	kHz	①
PFM Switching Current	I <sub>PFM</sub>	When connected to external components, V <sub>IN</sub> = 3.2V, V <sub>CE</sub> = V <sub>IN</sub> , I <sub>OUT</sub> = 1mA <sup>(**12)</sup>	170	220	270	mA	①
PFM Duty Limit	DTY <sub>LIMIT_PFM</sub>	V <sub>CE</sub> = V <sub>IN</sub> = 2.2V, I <sub>OUT</sub> = 1mA <sup>(**12)</sup>		200	300	%	①
Maximum Duty Cycle	D <sub>MAX</sub>	V <sub>IN</sub> = V <sub>CE</sub> = 5.0V, V <sub>FB</sub> = 0.72V	100	-	-	%	③
Minimum Duty Cycle	D <sub>MIN</sub>	V <sub>IN</sub> = V <sub>CE</sub> = 5.0V, V <sub>FB</sub> = 0.88V	-	-	0	%	③
Efficiency <sup>(**2)</sup>	EFFI	When connected to external components, V <sub>CE</sub> = V <sub>IN</sub> = 2.4V, I <sub>OUT</sub> = 100mA	-	86	-	%	①
Lx SW "H" ON Resistance 1	R <sub>LxH</sub>	V <sub>IN</sub> = V <sub>CE</sub> = 5.0V, V <sub>FB</sub> = 0.72V, I <sub>Lx</sub> = 100mA <sup>(**3)</sup>	-	0.35	0.55	Ω	④
Lx SW "H" ON Resistance 2	R <sub>LxH</sub>	V <sub>IN</sub> = V <sub>CE</sub> = 3.6V, V <sub>FB</sub> = 0.72V, I <sub>Lx</sub> = 100mA <sup>(**3)</sup>	-	0.42	0.67	Ω	④
Lx SW "L" ON Resistance 1	R <sub>LxL</sub>	V <sub>IN</sub> = V <sub>CE</sub> = 5.0V <sup>(**4)</sup>	-	0.45	0.65	Ω	-
Lx SW "L" ON Resistance 2	R <sub>LxL</sub>	V <sub>IN</sub> = V <sub>CE</sub> = 3.6V <sup>(**4)</sup>	-	0.52	0.77	Ω	-
Lx SW "H" Leak Current <sup>(**5)</sup>	I <sub>LEAKH</sub>	V <sub>IN</sub> = V <sub>FB</sub> = 5.0V, V <sub>CE</sub> = 0V, Lx = 0V	-	0.01	1.0	μA	⑨
Current Limit <sup>(**10)</sup>	I <sub>LIM</sub>	V <sub>IN</sub> = V <sub>CE</sub> = 5.0V, V <sub>FB</sub> = 0.72V <sup>(**6)</sup>	900	1050	1350	mA	⑥
Output Voltage Temperature Characteristics	ΔV <sub>OUT</sub> / (V <sub>OUT</sub> · ΔT <sub>opr</sub> )	I <sub>OUT</sub> = 30mA -40°C ≤ T <sub>opr</sub> ≤ 85°C	-	±100	-	ppm/°C	①
CE "H" Voltage	V <sub>CEH</sub>	V <sub>FB</sub> = 0.72V, V <sub>CE</sub> , Voltage changes Lx to "H" level <sup>(**11)</sup>	0.65	-	6.0	V	③
CE "L" Voltage	V <sub>CEL</sub>	V <sub>FB</sub> = 0.72V, V <sub>CE</sub> , Voltage changes Lx to "L" level <sup>(**11)</sup>	V <sub>SS</sub>	-	0.25	V	③
PWM "H" Level Voltage	V <sub>PWMH</sub>	When connected to external components, I <sub>OUT</sub> = 1mA <sup>(**6)</sup> , Voltage which oscillation frequency becomes 2550kHz ≤ f <sub>OSC</sub> ≤ 3450kHz <sup>(**13)</sup>	-	-	V <sub>IN</sub> - 1.0	V	①
PWM "L" Level Voltage	V <sub>PWML</sub>	When connected to external components, I <sub>OUT</sub> = 1mA <sup>(**6)</sup> , Voltage which oscillation frequency becomes f <sub>OSC</sub> < 2550kHz <sup>(**13)</sup>	V <sub>IN</sub> - 0.25	-	-	V	①
CE "H" Current	I <sub>CEH</sub>	V <sub>IN</sub> = V <sub>CE</sub> = 5.0V, V <sub>FB</sub> = 0.72V	- 0.1	-	0.1	μA	⑤
CE "L" Current	I <sub>CEL</sub>	V <sub>IN</sub> = 5.0V, V <sub>CE</sub> = 0V, V <sub>FB</sub> = 0.72V	- 0.1	-	0.1	μA	⑤
Soft Start Time (D series)	t <sub>SS</sub>	When connected to external components, V <sub>CE</sub> = 0V → V <sub>IN</sub> , I <sub>OUT</sub> = 1mA	0.5	1.0	2.5	ms	①
Soft Start Time (F series)			-	0.25	0.40		
Latch Time	t <sub>LAT</sub>	V <sub>IN</sub> = V <sub>CE</sub> = 5.0V, V <sub>FB</sub> = 0.64, Short Lx at 1Ω resistance <sup>(**7)</sup>	1.0	-	20.0	ms	⑦
Short Protection Threshold Voltage	V <sub>SHORT</sub>	V <sub>IN</sub> = V <sub>CE</sub> = 5.0V, The V <sub>FB</sub> at Lx="Low" <sup>(**11)</sup> while decreasing FB pin voltage from 0.4V.	0.15	0.200	0.25	V	⑦
C <sub>L</sub> Discharge	R <sub>DCHG</sub>	V <sub>IN</sub> = 5.0V, Lx = 5.0V, V <sub>CE</sub> = 0V, V <sub>FB</sub> = open	200	300	450	Ω	⑧

Test conditions: V<sub>OUT</sub>=1.2V when the external components are connected. Unless otherwise stated, V<sub>IN</sub>=5.0V, V<sub>OUT(E)</sub>=Nominal Voltage, applied voltage sequence is V<sub>OUT</sub>→V<sub>IN</sub>→V<sub>CE</sub>

NOTE:

- \*1: Including hysteresis operating voltage range.
- \*2: EFFI = { ( output voltage × output current ) / ( input voltage × input current ) } × 100
- \*3: ON resistance (Ω) = (V<sub>IN</sub> - Lx pin measurement voltage) / 100mA
- \*4: R&D value
- \*5: When temperature is high, a current of approximately 10 μA (maximum) may leak.
- \*6: The CE/MODE pin of the XC9237A series works also as an external switching pin of PWM control and PWM/PFM control. When the IC is in the operation, control is switched to the automatic PWM/PFM switching mode when the CE/MODE pin voltage is equal to or greater than V<sub>IN</sub> minus 0.3V, and to the PWM mode when the CE/MODE pin voltage is equal to or lower than V<sub>IN</sub> minus 1.0V and equal to or greater than V<sub>CEH</sub>.
- \*7: Time until it short-circuits V<sub>FB</sub> with GND via 1Ω of resistor from an operational state and is set to Lx=0V from current limit pulse generating.
- \*8: When V<sub>IN</sub> is less than 2.4V, limit current may not be reached because voltage falls caused by ON resistance.
- \*9: When the difference between the input and the output is small, some cycles may be skipped completely before current maximizes. If current is further pulled from this state, output voltage will decrease because of P-ch driver ON resistance.
- \*10: Current limit denotes the level of detection at peak of coil current.
- \*11: "H"=V<sub>IN</sub>-V<sub>IN</sub>-1.2V, "L"=+0.1V~-0.1V
- \*12: XC9235 series exclude I<sub>PFM</sub> and DTY<sub>LIMIT\_PFM</sub> because those are only for the PFM control's functions.
- \*13: XC9235/XC9236 series exclude V<sub>PWMH</sub> and V<sub>PWML</sub> because those are only for the XC9237 series' functions.

## ELECTRICAL CHARACTERISTICS (Continued)

### ● PFM Switching Current ( $I_{PFM}$ ) by Oscillation Frequency and Setting Voltage

(mA)

SETTING VOLTAGE	1.2MHz			3.0MHz		
	MIN.	TYP.	MAX.	MIN.	TYP.	MAX.
$V_{OUT(E)} \leq 1.2V$	140	180	240	190	260	350
$1.2V < V_{OUT(E)} \leq 1.75V$	130	170	220	180	240	300
$1.8V \leq V_{OUT(E)}$	120	160	200	170	220	270

### ● Input Voltage ( $V_{IN}$ ) for Measuring PFM Duty Limit ( $DTY_{LIMIT\_PFM}$ )

$f_{OSC}$	1.2MHz	3.0MHz
C-1	$V_{OUT(E)}+0.5V$	$V_{OUT(E)}+1.0V$

Minimum operating voltage is 2.0V.

ex.) Although when  $V_{OUT(E)}$  is 1.2V and  $f_{OSC}$  is 1.2MHz, (C-1) should be 1.7V, (C-1) becomes 2.0V for the minimum operating voltage 2.0V.

### ● Soft-Start Time, Setting Voltage (XC9235B(G)/XC9236B(G)/XC9237B(G) Series only)

( $\mu s$ )

SERIES	$f_{OSC}$	SETTING VOLTAGE	MIN.	TYP.	MAX.
XC9235B(G)/XC9237B(G)	1.2MHz	$0.8 \leq V_{OUT(E)} < 1.5$	-	250	400
	1.2MHz	$1.5 \leq V_{OUT(E)} < 1.8$	-	320	500
	1.2MHz	$1.8 \leq V_{OUT(E)} < 2.5$	-	250	400
	1.2MHz	$2.5 \leq V_{OUT(E)} < 4.0$	-	320	500
XC9236B(G)	1.2MHz	$0.8 \leq V_{OUT(E)} < 2.5$	-	250	400
	1.2MHz	$2.5 \leq V_{OUT(E)} < 4.0$	-	320	500
XC9235B(G)/ XC9236B(G)/XC9237B(G)	3.0MHz	$0.8 \leq V_{OUT(E)} < 1.8$	-	250	400
	3.0MHz	$1.8 \leq V_{OUT(E)} < 4.0$	-	320	500

## TYPICAL APPLICATION CIRCUIT

### XC9235/XC9236/XC9237A, B, C, E, G Series (Output Voltage Fixed)

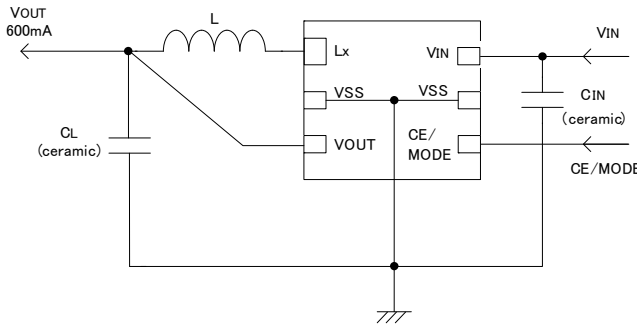

- $f_{OSC}=3.0\text{MHz}$ 
  - L: 1.5  $\mu\text{H}$  (NR3015, TAIYO YUDEN)
  - $C_{IN}$ : 4.7  $\mu\text{F}$  (Ceramic)
  - $C_L$ : 10  $\mu\text{F}$  (Ceramic)
- $f_{OSC}=1.2\text{MHz}$ 
  - L: 4.7  $\mu\text{H}$  (NR4018, TAIYO YUDEN)
  - $C_{IN}$ : 4.7  $\mu\text{F}$  (Ceramic)
  - $C_L$ : 10  $\mu\text{F}$  (Ceramic)

### XC9235/XC9236/XC9237D, F Series (Output Voltage External Setting)

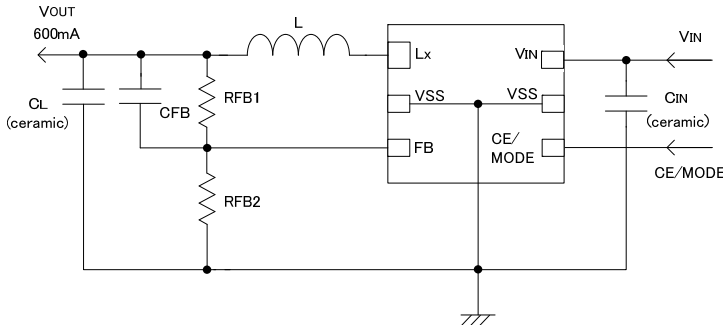

#### <Setting for Output Voltage>

Output voltage can be set externally by adding two resistors to the FB pin. The output voltage is calculated by the  $R_{FB1}$  and  $R_{FB2}$  value. The total of  $R_{FB1}$  and  $R_{FB2}$  is usually selected less than 1M $\Omega$ .

Output voltages can be set in the range of 0.9V to 0.6V by use of 0.8V $\pm$ 2.0% reference voltage. However, when input voltage ( $V_{IN}$ ) is lower than the setting output voltage, output voltage ( $V_{OUT}$ ) can not be higher than the input voltage ( $V_{IN}$ ).

$$V_{OUT}=0.8 \times (R_{FB1}+R_{FB2})/R_{FB2}$$

The value of the phase compensation speed-up capacitor  $C_{FB}$  is calculated by the formula of  $f_{ZFB} = 1/(2 \times \pi \times C_{FB} \times R_{FB1})$  with  $f_{ZFB} < 10\text{kHz}$ . For optimization,  $f_{ZFB}$  can be adjusted in the range of 1kHz to 20kHz depending on the inductance L and the load capacitance  $C_L$  which are used.

#### 【Formula】

When  $R_{FB1}=470\text{k}\Omega$  and  $R_{FB2}=150\text{k}$ ,  $V_{OUT1}=0.8 \times (470\text{k}+150\text{k}) / 150\text{k}=3.3\text{V}$

#### 【Example】

$V_{OUT}$ (V)	$R_{FB1}$ (k $\Omega$ )	$R_{FB2}$ (k $\Omega$ )	$C_{FB}$ (pF)	$V_{OUT}$ (V)	$R_{FB1}$ (k $\Omega$ )	$R_{FB2}$ (k $\Omega$ )	$C_{FB}$ (pF)
0.9	100	820	150	2.5	510	240	100
1.2	150	300	100	3.0	330	120	150
1.5	130	150	220	3.3	470	150	100
1.8	300	240	150	4.0	120	30	470

## OPERATIONAL DESCRIPTION

The XC9235/XC9236/XC9237 series consists of a reference voltage source, ramp wave circuit, error amplifier, PWM comparator, phase compensation circuit, output voltage adjustment resistors, P-channel MOS driver transistor, N-channel MOS switching transistor for the synchronous switch, current limiter circuit, UVLO circuit and others. (See the block diagram above.) The series ICs compare, using the error amplifier, the voltage of the internal voltage reference source with the feedback voltage from the V<sub>OUT</sub> pin through split resistors, R1 and R2. Phase compensation is performed on the resulting error amplifier output, to input a signal to the PWM comparator to determine the turn-on time during PWM operation. The PWM comparator compares, in terms of voltage level, the signal from the error amplifier with the ramp wave from the ramp wave circuit, and delivers the resulting output to the buffer driver circuit to cause the Lx pin to output a switching duty cycle. This process is continuously performed to ensure stable output voltage. The current feedback circuit monitors the P-channel MOS driver transistor current for each switching operation, and modulates the error amplifier output signal to provide multiple feedback signals. This enables a stable feedback loop even when a low ESR capacitor such as a ceramic capacitor is used ensuring stable output voltage.

### <Reference Voltage Source>

The reference voltage source provides the reference voltage to ensure stable output voltage of the DC/DC converter.

### <Ramp Wave Circuit>

The ramp wave circuit determines switching frequency. The frequency is fixed internally and can be selected from 1.2MHz or 3.0MHz. Clock pulses generated in this circuit are used to produce ramp waveforms needed for PWM operation, and to synchronize all the internal circuits.

### <Error Amplifier>

The error amplifier is designed to monitor output voltage. The amplifier compares the reference voltage with the feedback voltage divided by the internal split resistors, R1 and R2. When a voltage lower than the reference voltage is fed back, the output voltage of the error amplifier increases. The gain and frequency characteristics of the error amplifier output are fixed internally to deliver an optimized signal to the mixer.

### <Current Limit>

The current limiter circuit of the XC9235/XC9236/XC9237 series monitors the current flowing through the P-channel MOS driver transistor connected to the Lx pin, and features a combination of the current limit mode and the operation suspension mode.

- ① When the driver current is greater than a specific level, the current limit function operates to turn off the pulses from the Lx pin at any given timing.
- ② When the driver transistor is turned off, the limiter circuit is then released from the current limit detection state.
- ③ At the next pulse, the driver transistor is turned on. However, the transistor is immediately turned off in the case of an over current state.
- ④ When the over current state is eliminated, the IC resumes its normal operation.

The IC waits for the over current state to end by repeating the steps ① through ③. If an over current state continues for a few ms and the above three steps are repeatedly performed, the IC performs the function of latching the OFF state of the driver transistor, and goes into operation suspension mode. Once the IC is in suspension mode, operations can be resumed by either turning the IC off via the CE/MODE pin, or by restoring power to the V<sub>IN</sub> pin. The suspension mode does not mean a complete shutdown, but a state in which pulse output is suspended; therefore, the internal circuitry remains in operation. The current limit of the XC9235/XC9236/XC9237 series can be set at 1050mA at typical. Besides, care must be taken when laying out the PC Board, in order to prevent misoperation of the current limit mode. Depending on the state of the PC Board, latch time may become longer and latch operation may not work. In order to avoid the effect of noise, the board should be laid out so that input capacitors are placed as close to the IC as possible.



## ■ OPERATIONAL DESCRIPTION (Continued)

### <Short-Circuit Protection>

The short-circuit protection circuit monitors the internal R1 and R2 divider voltage from the V<sub>OUT</sub> pin (refer to FB point in the block diagram shown in the previous page). In case where output is accidentally shorted to the Ground and when the FB point voltage decreases less than half of the reference voltage (V<sub>ref</sub>) and a current more than the I<sub>LIM</sub> flows to the Pch MOS driver transistor, the short-circuit protection quickly operates to turn off and to latch the driver transistor. For the D/E/F/G series, it does not matter how much the current limit, once the FB voltage become less than the quarter of reference voltage (V<sub>REF</sub>), the short-circuit protection operates to latch the Pch MOS driver transistor. In latch mode, the operation can be resumed by either turning the IC off and on via the CE/MODE pin, or by restoring power supply to the V<sub>IN</sub> pin.

When sharp load transient happens, a voltage drop at the V<sub>OUT</sub> is propagated to the FB point through C<sub>FB</sub>, as a result, short circuit protection may operate in the voltage higher than 1/2 V<sub>OUT</sub> voltage.

### <UVLO Circuit>

When the V<sub>IN</sub> pin voltage becomes 1.4V or lower, the Pch MOS driver transistor output driver transistor is forced OFF to prevent false pulse output caused by unstable operation of the internal circuitry. When the V<sub>IN</sub> pin voltage becomes 1.8V or higher, switching operation takes place. By releasing the UVLO function, the IC performs the soft start function to initiate output startup operation. The soft start function operates even when the V<sub>IN</sub> pin voltage falls momentarily below the UVLO operating voltage. The UVLO circuit does not cause a complete shutdown of the IC, but causes pulse output to be suspended; therefore, the internal circuitry remains in operation.

### <PFM Switch Current>

In PFM control operation, until coil current reaches to a specified level (I<sub>PFM</sub>), the IC keeps the Pch MOS driver transistor on. In this case, time that the Pch MOS driver transistor is kept on (T<sub>ON</sub>) can be given by the following formula.

$$t_{ON} = L \times I_{PFM} / (V_{IN} - V_{OUT}) \rightarrow I_{PFM} \textcircled{1}$$

### < PFM Duty Limit >

In PFM control operation, the PFM duty limit (DTY<sub>LIMIT\_PFM</sub>) is set to 200% (TYP.). Therefore, under the condition that the duty increases (e.g. the condition that the step-down ratio is small), it's possible for Pch MOS driver transistor to be turned off even when coil current doesn't reach to I<sub>PFM</sub>.  $\rightarrow I_{PFM} \textcircled{2}$

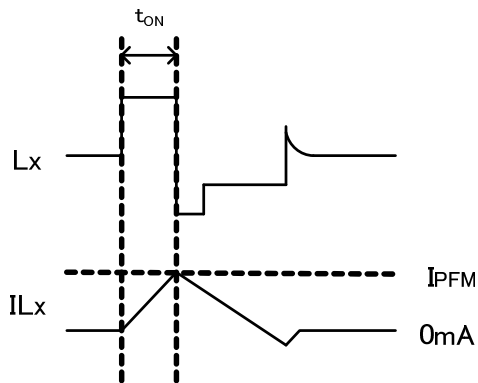

Fig. I<sub>PFM</sub> ①

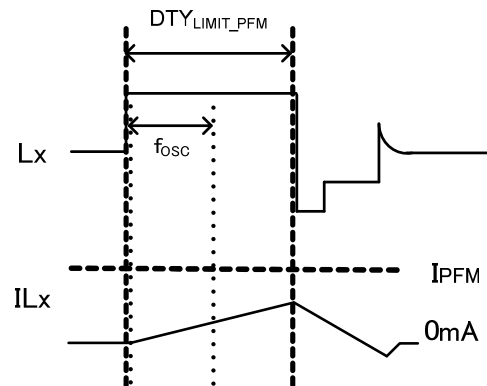

Fig. I<sub>PFM</sub> ②

## OPERATIONAL DESCRIPTION (Continued)

### <CL High Speed Discharge>

XC9235B(C)(D)(E)(F)(G)/ XC9236B(C)(D)(E)(F)(G)/ XC9237B(C)(D)(E)(F)(G) series can quickly discharge the electric charge at the output capacitor (CL) when a low signal to the CE pin which enables a whole IC circuit put into OFF state, is inputted via the Nch MOS switch transistor located between the Lx pin and the VSS pin. When the IC is disabled, electric charge at the output capacitor (CL) is quickly discharged so that it may avoid application malfunction. Discharge time of the output capacitor (CL) is set by the CL auto-discharge resistance (R) and the output capacitor (CL). By setting time constant of a CL auto-discharge resistance value [R] and an output capacitor value (CL) as  $\tau$  ( $\tau = C \times R$ ), discharge time of the output voltage after discharge via the N channel transistor is calculated by the following formulas.

$$V = V_{OUT(E)} \times e^{-t/\tau} \text{ or } t = \tau \ln (V_{OUT(E)} / V)$$

V : Output voltage after discharge

$V_{OUT(E)}$  : Output voltage

t: Discharge time

$\tau$  :  $C \times R$

C= Capacitance of Output capacitor (CL)

R= CL auto-discharge resistance

Output Voltage Discharge Characteristics  
Rdischg = 300  $\Omega$  (TYP)

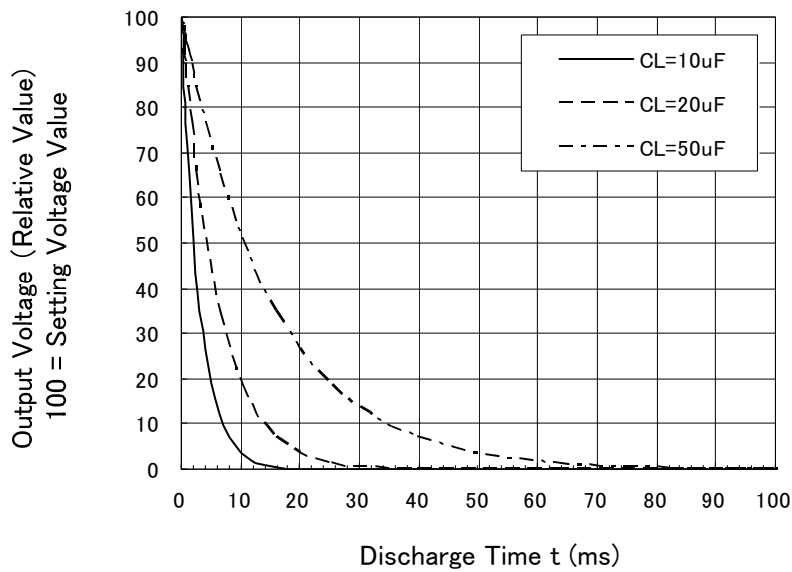

## OPERATIONAL DESCRIPTION (Continued)

### <CE/MODE Pin Function>

The operation of the XC9235/XC9236/XC9237 series will enter into the shut down mode when a low level signal is input to the CE/MODE pin. During the shutdown mode, the current consumption of the IC becomes  $0\mu A$  (TYP.), with a state of high impedance at the Lx pin and VOUT pin. The IC starts its operation by inputting a high level signal to the CE/MODE pin. The input to the CE/MODE pin is a CMOS input and the sink current is  $0\mu A$  (TYP.).

### XC9235/XC9236 series - Examples of how to use CE/MODE pin

(A)

SW_CE	STATUS
ON	Stand-by
OFF	Operation

(B)

SW_CE	STATUS
ON	Operation
OFF	Stand-by

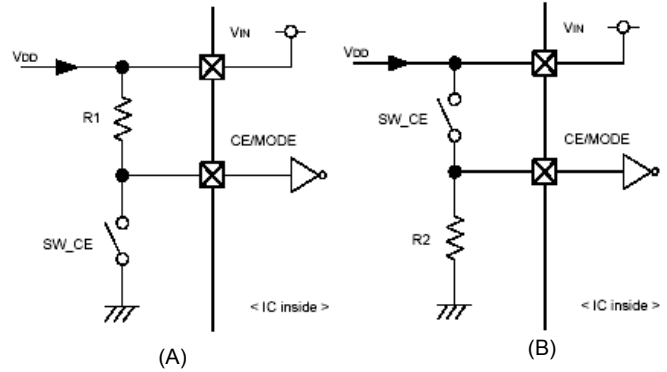

### XC9237 series - Examples of how to use CE/MODE pin

(A)

SW_CE	SW_PWM/PFM	STATUS
ON	*	PWM/PFM Automatic Switching Control
OFF	ON	PWM Control
OFF	OFF	Stand-by

(B)

SW_CE	SW_PWM/PFM	STATUS
ON	*	Stand-by
OFF	ON	PWM Control
OFF	OFF	PWM/PFM Automatic Switching Control



Intermediate voltage can be generated by RM1 and RM2. Please set the value of each R1, R2, RM1, RM2 from few hundreds  $k\Omega$  to few hundreds  $M\Omega$ . For switches, CPU open-drain I/O port and transistor can be used.

## ■ OPERATIONAL DESCRIPTION (Continued)

### <Soft Start>

Soft start time is available in two options via product selection.

The A,C,D,and E types of XC9235/XC9236/XC9237 series provide 1.0ms (TYP).

The B,F, and G types of XC9235/ XC9236/XC9237 series provide 0.25ms (TYP). However, for the D/F the soft-start time can be set by the external components. Soft start time is defined as the time interval to reach 90% of the output voltage from the time when the CE pin is turned on.



## NOTE ON USE

- For temporary, transitional voltage drop or voltage rising phenomenon, the IC is liable to malfunction should the ratings be exceeded.
  - The XC9235/XC9236/XC9237 series is designed for use with ceramic output capacitors. If, however, the potential difference is too large between the input voltage and the output voltage, a ceramic capacitor may fail to absorb the resulting high switching energy and oscillation could occur on the output. If the input-output potential difference is large, connect an electrolytic capacitor in parallel to compensate for insufficient capacitance.
  - Spike noise and ripple voltage arise in a switching regulator as with a DC/DC converter. These are greatly influenced by external component selection, such as the coil inductance, capacitance values, and board layout of external components. Once the design has been completed, verification with actual components should be done.
  - Depending on the input-output voltage differential, or load current, some pulses may be skipped, and the ripple voltage may increase.
  - When the difference between  $V_{IN}$  and  $V_{OUT}$  is large in PWM control, very narrow pulses will be outputted, and there is the possibility that some cycles may be skipped completely.
  - When the difference between  $V_{IN}$  and  $V_{OUT}$  is small, and the load current is heavy, very wide pulses will be outputted and there is the possibility that some cycles may be skipped completely.
  - With the IC, the peak current of the coil is controlled by the current limit circuit. Since the peak current increases when dropout voltage or load current is high, current limit starts operation, and this can lead to instability. When peak current becomes high, please adjust the coil inductance value and fully check the circuit operation. In addition, please calculate the peak current according to the following formula:  

$$I_{pk} = (V_{IN} - V_{OUT}) \times \text{OnDuty} / (2 \times L \times f_{osc}) + I_{OUT}$$

L: Coil Inductance Value  
 $f_{osc}$ : Oscillation Frequency
  - When the peak current which exceeds limit current flows within the specified time, the built-in Pch MOS driver transistor turns off. During the time until it detects limit current and before the built-in transistor can be turned off, the current for limit current flows; therefore, care must be taken when selecting the rating for the external components such as a coil.
  - When  $V_{IN}$  is less than 2.4V, limit current may not be reached because voltage falls caused by ON resistance.
  - Care must be taken when laying out the PC Board, in order to prevent misoperation of the current limit mode. Depending on the state of the PC Board, latch time may become longer and latch operation may not work. In order to avoid the effect of noise, the board should be laid out so that input capacitors are placed as close to the IC as possible.
  - Use of the IC at voltages below the recommended voltage range may lead to instability.
  - This IC should be used within the stated absolute maximum ratings in order to prevent damage to the device.
  - When the IC is used in high temperature, output voltage may increase up to input voltage level at no load because of the leak current of the driver transistor.
  - The current limit is set to 1350mA (MAX.) at typical. However, the current of 1350mA or more may flow. In case that the current limit functions while the  $V_{OUT}$  pin is shorted to the GND pin, when Pch MOS driver transistor is ON, the potential difference for input voltage will occur at both ends of a coil. For this, the time rate of coil current becomes large. By contrast, when Nch MOS driver transistor is ON, there is almost no potential difference at both ends of the coil since the  $V_{OUT}$  pin is shorted to the GND pin. Consequently, the time rate of coil current becomes quite small. According to the repetition of this operation, and the delay time of the circuit, coil current will be converged on a certain current value, exceeding the amount of current, which is supposed to be limited originally. Even in this case, however, after the over current state continues for several ms, the circuit will be latched. A coil should be used within the stated absolute maximum rating in order to prevent damage to the device.
- ① Current flows into Pch MOS driver transistor to reach the current limit ( $I_{LIM}$ ).
  - ② The current of  $I_{LIM}$  or more flows since the delay time of the circuit occurs during from the detection of the current limit to OFF of Pch MOS driver transistor.
  - ③ Because of no potential difference at both ends of the coil, the time rate of coil current becomes quite small.
  - ④  $L_x$  oscillates very narrow pulses by the current limit for several ms.
  - ⑤ The circuit is latched, stopping its operation.



## NOTE ON USE (Continued)

15. In order to stabilize  $V_{IN}$ 's voltage level and oscillation frequency, we recommend that a by-pass capacitor ( $C_{IN}$ ) be connected as close as possible to the  $V_{IN}$  &  $V_{SS}$  pins.
16. High step-down ratio and very light load may lead an intermittent oscillation.
17. During PWM / PFM automatic switching mode, operating may become unstable at transition to continuous mode. Please verify with actual parts.

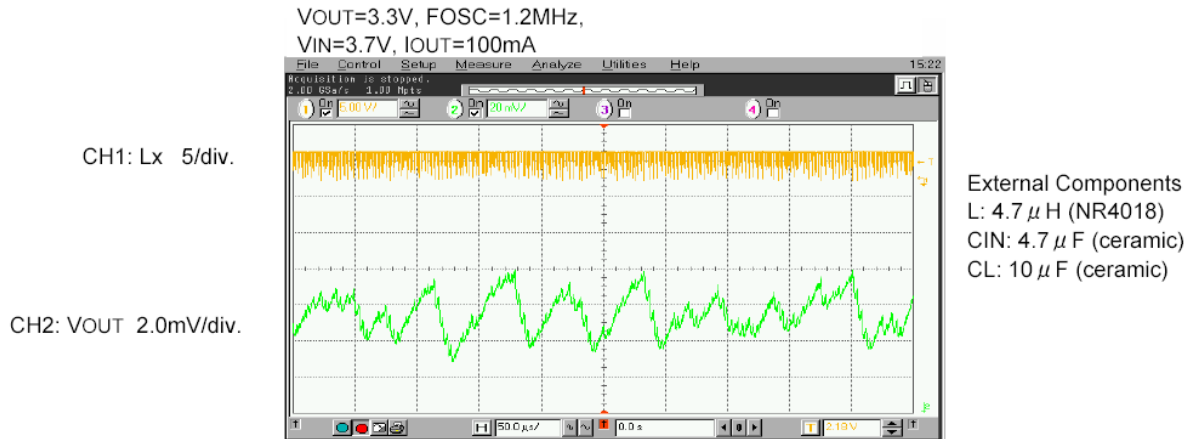

18. Please note the inductance value of the coil. The IC may enter unstable operation if the combination of ambient temperature, setting voltage, oscillation frequency, and L value are not adequate. In the operation range close to the maximum duty cycle, The IC may happen to enter unstable output voltage operation even if using the L values listed below.

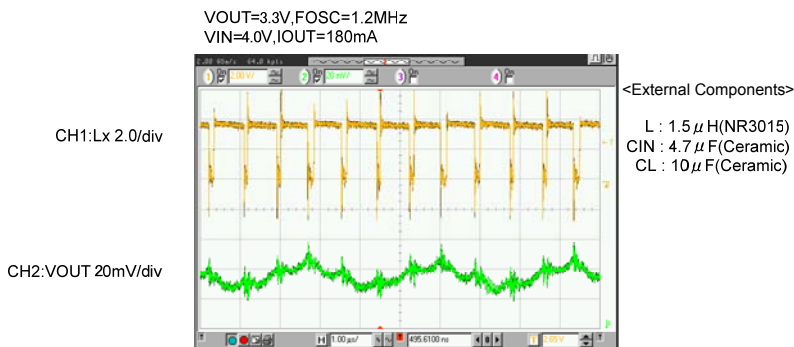

### ● The Range of L Value

$f_{OSC}$	$V_{OUT}$	L Value
3.0MHz	$0.8V < V_{OUT} < 4.0V$	1.0 $\mu$ H ~ 2.2 $\mu$ H
1.2MHz	$V_{OUT} \leq 2.5V$	3.3 $\mu$ H ~ 6.8 $\mu$ H
	$2.5V < V_{OUT}$	4.7 $\mu$ H ~ 6.8 $\mu$ H

\*When a coil less value of 4.7 $\mu$ H is used at  $f_{OSC}=1.2MHz$  or when a coil less value of 1.5 $\mu$ H is used at  $f_{OSC}=3.0MHz$ , peak coil current more easily reach the current limit  $I_{LMI}$ . In this case, it may happen that the IC can not provide 600mA output current.

19. It may happen to enter unstable operation when the IC goes into continuous operation mode under the condition of large input-output voltage difference. Care must be taken with the actual design unit.



20. Torex places an importance on improving our products and their reliability. We request that users incorporate fail-safe designs and post-aging protection treatment when using Torex products in their systems.

## NOTE ON USE (Continued)

### 21. Instructions of pattern layouts

- (1) In order to stabilize  $V_{IN}$  voltage level, we recommend that a by-pass capacitor ( $C_{IN}$ ) be connected as close as possible to the  $V_{IN}$  &  $V_{SS}$  pins.
- (2) Please mount each external component as close to the IC as possible.
- (3) Wire external components as close to the IC as possible and use thick, short connecting traces to reduce the circuit impedance.
- (4) Make sure that the PCB GND traces are as thick as possible, as variations in ground potential caused by high ground currents at the time of switching may result in instability of the IC.
- (5) This series' internal driver transistors bring on heat because of the output current and ON resistance of driver transistors.

XC9235/XC9236/XC9237 A,B,C (Output Voltage Fixed)  
(PKG:SOT-25)

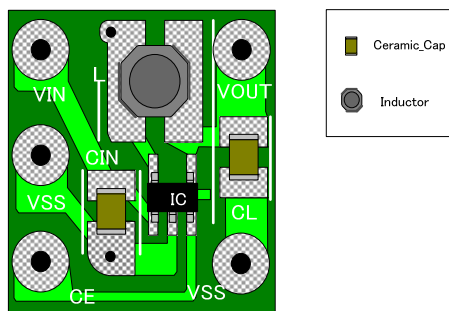

For the  $V_{IN}$ ,  $V_{OUT}$ ,  $V_{SS}$ ,  $CE$ , please put the wire.

XC9235/XC9236/XC9237 A,B,C,E,G (Output Voltage Fixed)  
(PKG:USP-6C/USP-6EL)

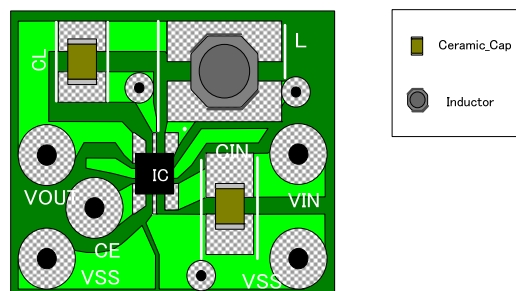

For the  $V_{IN}$ ,  $V_{OUT}$ ,  $V_{SS}$ ,  $CE$ , please put the wire.

XC9235/XC9236/XC9237 A,B (Output Voltage Fixed)  
(PKG:WLP-5-03)

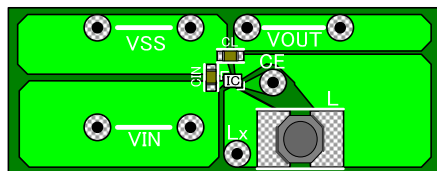

For the  $V_{IN}$ ,  $V_{OUT}$ ,  $V_{SS}$ ,  $CE$ , please put the wire.



XC9235/XC9236/XC9237 D,F (Output Voltage External Setting)  
(PKG:USP-6C)

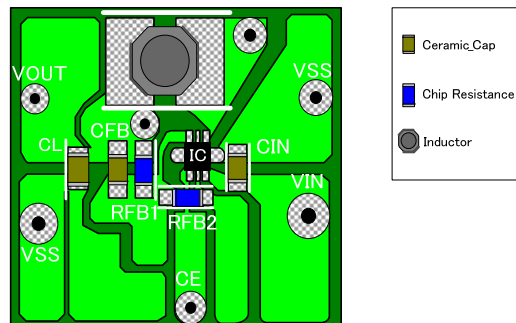

For the  $V_{IN}$ ,  $V_{OUT}$ ,  $V_{SS}$ ,  $CE$ , please put the wire.

### 22. NOTE ON MOUNTING (WLP-5-03)

- (1) Mount pad design should be optimized for user's conditions.
- (2) Sn-AG-Cu is used for the package terminals. If eutectic solder is used, mounting reliability is decreased. Please do not use eutectic solder paste.
- (3) When underfill agent is used to increase interfacial bonding strength, please take enough evaluation for selection. Some underfill materials and applied conditions may decrease bonding reliability.
- (4) The IC has exposed surface of silicon material in the top marking face and sides so that it is weak against mechanical damages. Please take care of handling to avoid cracks and breaks.
- (5) The IC has exposed surface of silicon material in the top marking face and sides. Please use the IC with keeping the circuit open (avoiding short-circuit from the out).
- (6) Semi-transparent resin is coated on the circuit face of the package. Please be noted that the usage under strong lights may affects device performance.

## TEST CIRCUITS

< Circuit No.1 >

•A/B/C/E/G series

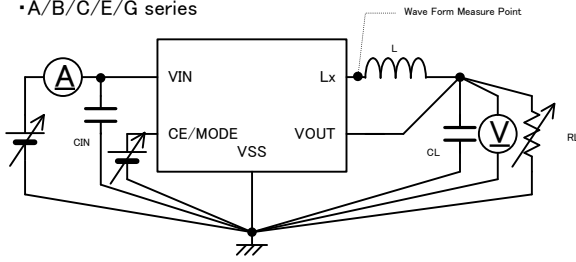

※ External Components

L : 1.5 $\mu$ H(NR3015) 3.0MHz  
4.7 $\mu$ H(NR4018) 1.2MHz

CIN : 4.7  $\mu$ F(ceramic)  
CL : 10  $\mu$ F(ceramic)

•D/F series

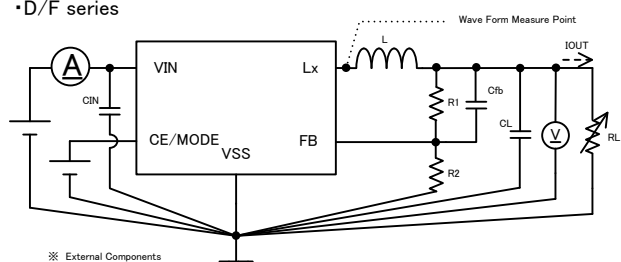

※ External Components

L : 1.5  $\mu$ H(NR4018) 3.0MHz  
4.7  $\mu$ H(NR3015) 1.2MHz

CIN : 4.7  $\mu$ F

CL : 10  $\mu$ F

R1 : 150k $\Omega$

R2 : 300k $\Omega$

Cfb : 120pF

$$V_{out} = V_{in} \times (R1 + R2) / R2$$

< Circuit No.2 >

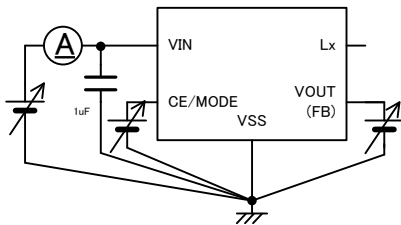

< Circuit No.3 >

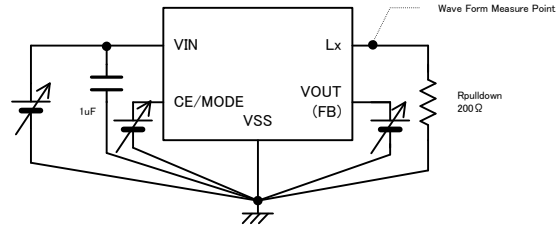

< Circuit No.4 >

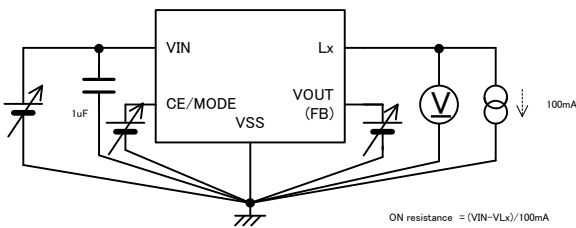

$$ON\ resistance = (VIN - VLx) / 100mA$$

< Circuit No.5 >

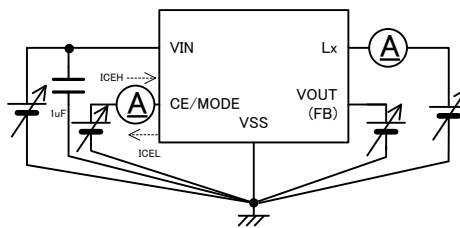

< Circuit No.6 >

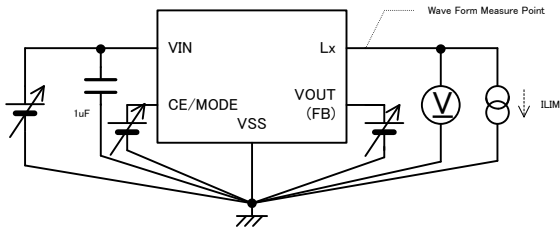

< Circuit No.7 >

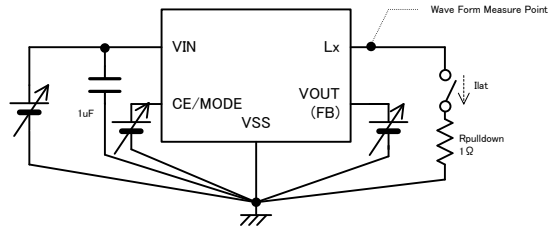

< Circuit No.8 >

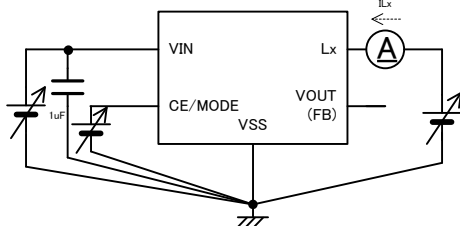

< Circuit No.9 >

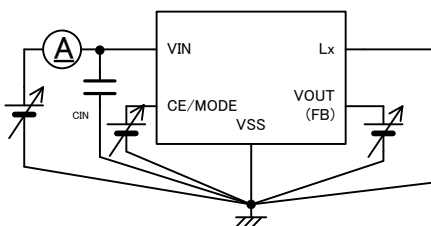

## TYPICAL PERFORMANCE CHARACTERISTICS

### (1) Efficiency vs. Output Current

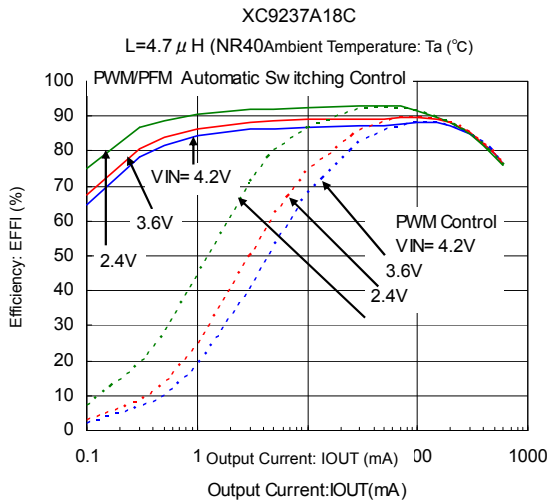

### (2) Output Voltage vs. Output Current

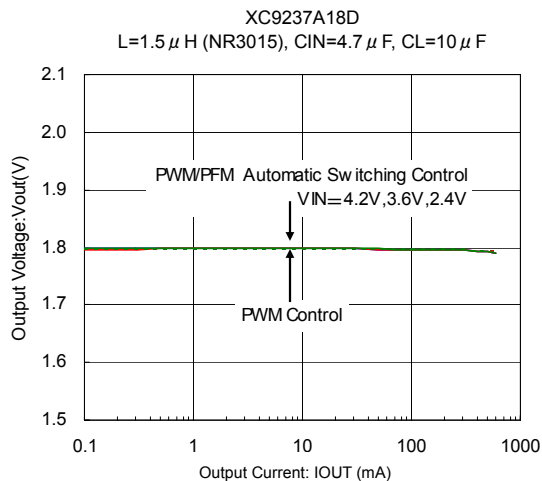
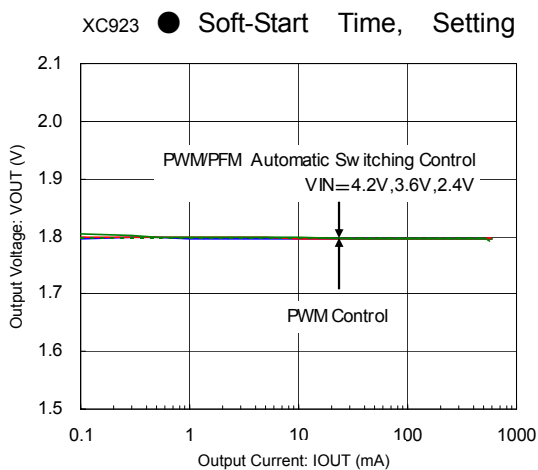

### (3) Ripple Voltage vs. Output Current

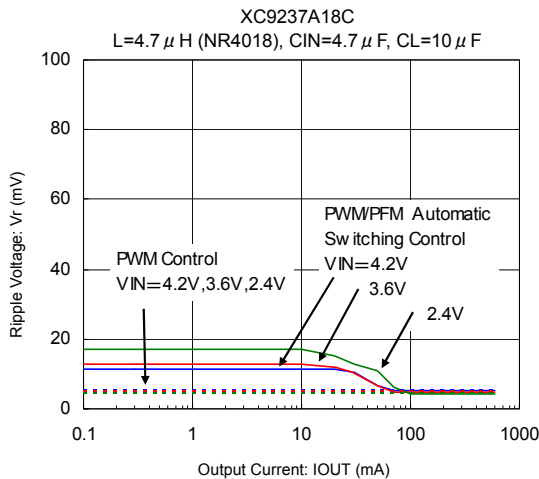

## TYPICAL PERFORMANCE CHARACTERISTICS (Continued)

(4) Oscillation Frequency vs. Ambient Temperature

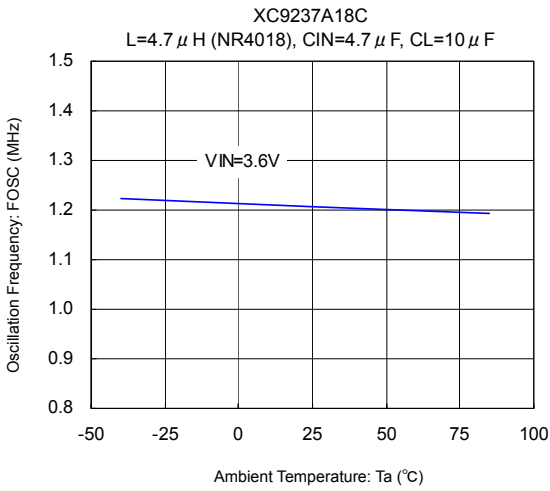

(5) Supply Current vs. Ambient Temperature

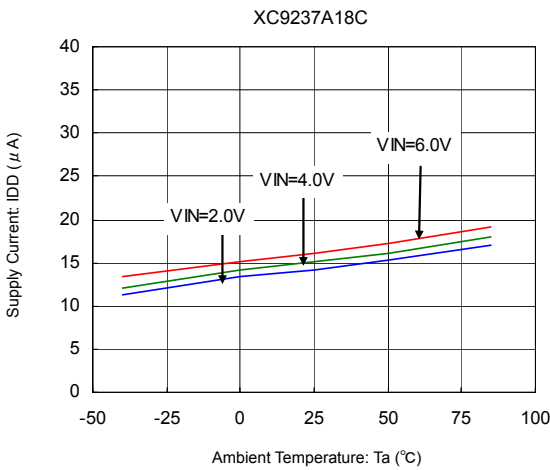

(6) Output Voltage vs. Ambient Temperature

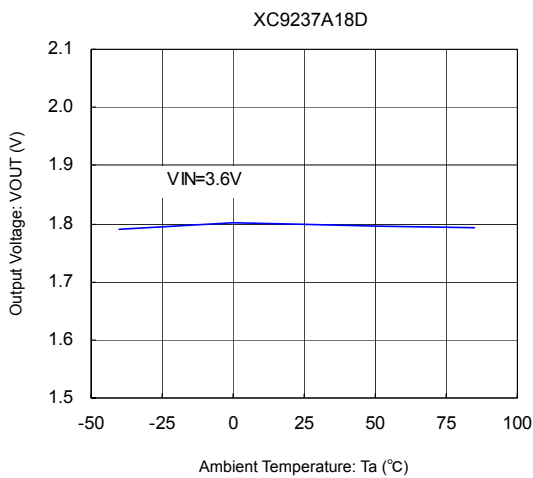

(7) UVLO Voltage vs. Ambient Temperature



## TYPICAL PERFORMANCE CHARACTERISTICS (Continued)

(8) CE "H" Voltage vs. Ambient Temperature



(9) CE "L" Voltage vs. Ambient Temperature



(10) Soft Start Time vs. Ambient Temperature



(11) "Pch / Nch" Driver on Resistance vs. Input Voltage



## TYPICAL PERFORMANCE CHARACTERISTICS (Continued)

(12) XC9235B/36B/37B Rise Wave Form

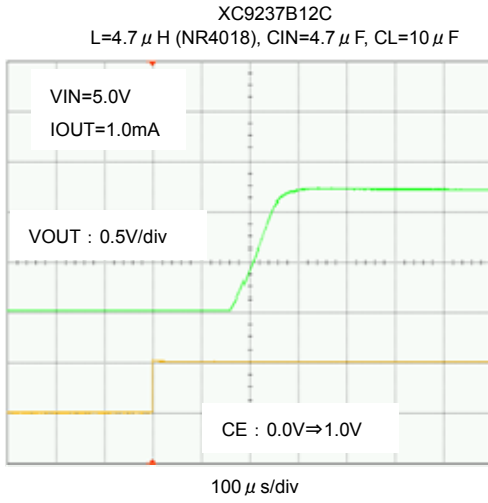

(13) XC9235B/36B/37B Soft-Start Time vs. Ambient Temperature



(14) XC9235B/36B/37B CL Discharge Resistance vs. Ambient Temperature



## ■ TYPICAL PERFORMANCE CHARACTERISTICS (Continued)

### (15) Load Transient Response

XC9237A18C

$L=4.7\ \mu\text{H}$  (NR4018),  $C_{\text{IN}}=4.7\ \mu\text{F}$  (ceramic),  $C_{\text{L}}=10\ \mu\text{F}$  (ceramic),  $T_{\text{opr}}=25^\circ\text{C}$

$V_{\text{IN}}=3.6\text{V}$ ,  $V_{\text{CE}}=V_{\text{IN}}$  (PWM/PFM Automatic Switching Control)

$I_{\text{OUT}}=1\text{mA} \rightarrow 100\text{mA}$

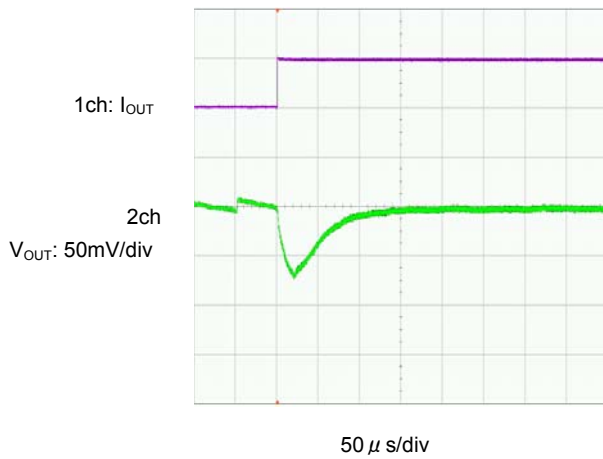

$I_{\text{OUT}}=1\text{mA} \rightarrow 300\text{mA}$

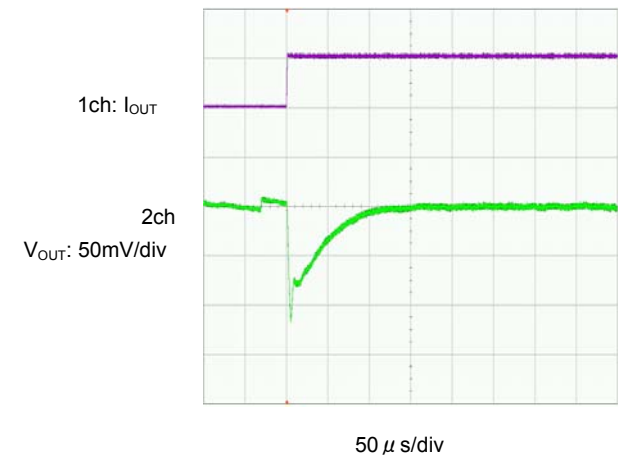

$I_{\text{OUT}}=100\text{mA} \rightarrow 1\text{mA}$

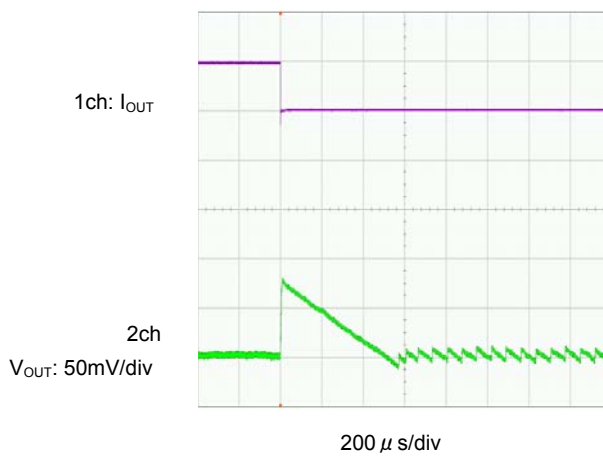

$I_{\text{OUT}}=300\text{mA} \rightarrow 1\text{mA}$



## TYPICAL PERFORMANCE CHARACTERISTICS (Continued)

(15) Load Transient Response (Continued)

XC9237A18C

$L=4.7\ \mu\text{H}$  (NR4018),  $C_{\text{IN}}=4.7\ \mu\text{F}$  (ceramic),  $C_{\text{L}}=10\ \mu\text{F}$  (ceramic),  $T_{\text{opr}}=25^\circ\text{C}$

$V_{\text{IN}}=3.6\text{V}$ ,  $V_{\text{CE}}=1.8\text{V}$  (PWM Control)

$I_{\text{OUT}}=1\text{mA} \rightarrow 100\text{mA}$



$I_{\text{OUT}}=1\text{mA} \rightarrow 300\text{mA}$

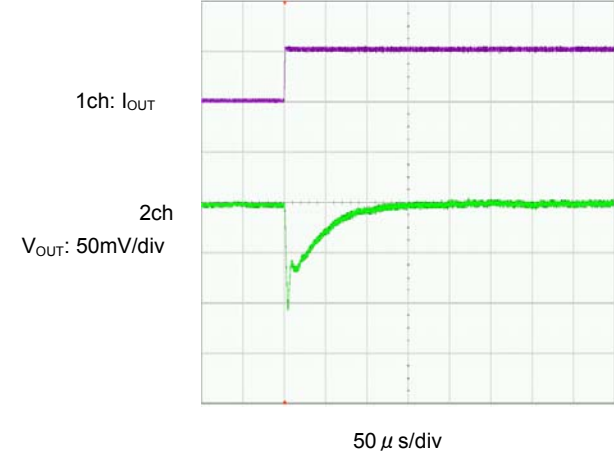

$I_{\text{OUT}}=100\text{mA} \rightarrow 1\text{mA}$



$I_{\text{OUT}}=300\text{mA} \rightarrow 1\text{mA}$



## ■ TYPICAL PERFORMANCE CHARACTERISTICS (Continued)

(15) Load Transient Response (Continued)

XC9237A18D

$L=1.5\ \mu\text{H}$  (NR3015),  $C_{\text{IN}}=4.7\ \mu\text{F}$  (ceramic),  $C_{\text{L}}=10\ \mu\text{F}$  (ceramic),  $T_{\text{opr}}=25^\circ\text{C}$

$V_{\text{IN}}=3.6\text{V}$ ,  $V_{\text{CE}}=V_{\text{IN}}$  (PWM/PFM Automatic Switching Control)

$I_{\text{OUT}}=1\text{mA} \rightarrow 100\text{mA}$



$I_{\text{OUT}}=1\text{mA} \rightarrow 300\text{mA}$



$I_{\text{OUT}}=100\text{mA} \rightarrow 1\text{mA}$



$I_{\text{OUT}}=300\text{mA} \rightarrow 1\text{mA}$



## TYPICAL PERFORMANCE CHARACTERISTICS (Continued)

(15) Load Transient Response (Continued)

XC9237A18D

$L=1.5\ \mu\text{H}$  (NR3015),  $C_{IN}=4.7\ \mu\text{F}$  (ceramic),  $C_L=10\ \mu\text{F}$  (ceramic),  $T_{opr}=25^\circ\text{C}$

$V_{IN}=3.6\text{V}$ ,  $V_{CE}=1.8\text{V}$  (PWM Control)

$I_{OUT}=1\text{mA} \rightarrow 100\text{mA}$



50  $\mu\text{s/div}$

$I_{OUT}=1\text{mA} \rightarrow 300\text{mA}$

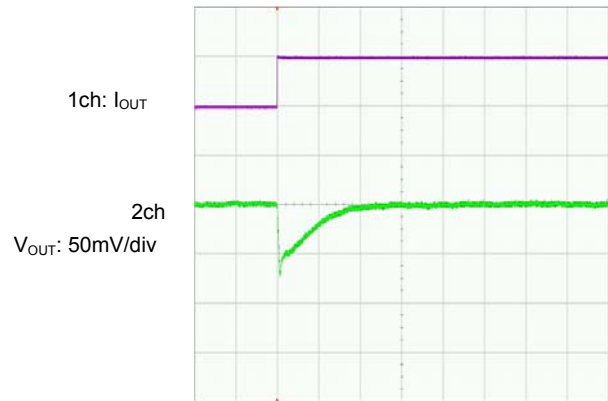

50  $\mu\text{s/div}$

$I_{OUT}=100\text{mA} \rightarrow 1\text{mA}$

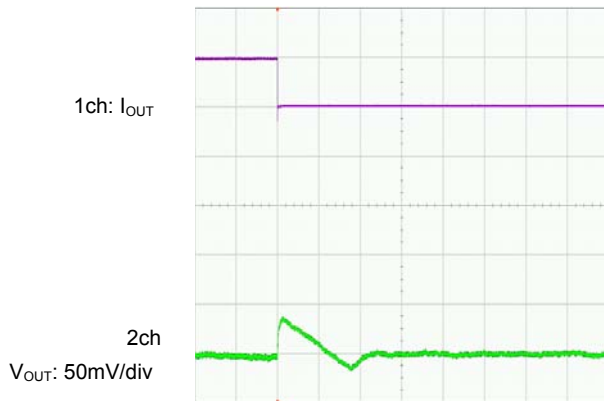

200  $\mu\text{s/div}$

$I_{OUT}=300\text{mA} \rightarrow 1\text{mA}$



200  $\mu\text{s/div}$

## PACKAGING INFORMATION

### ● SOT-25

(unit : mm)

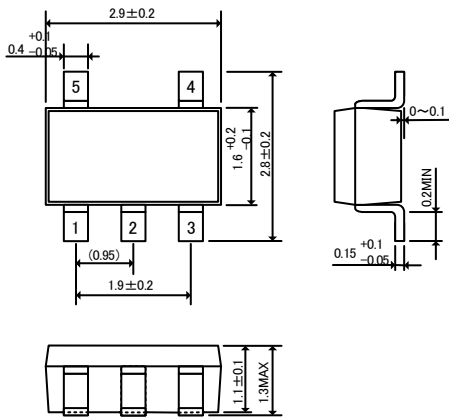

### ● SOT-25 Reference Pattern Layout

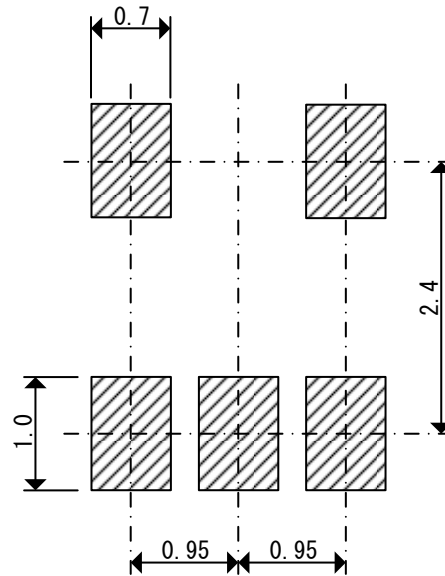



■ PACKAGING INFORMATION (Continued)

● USP-6EL

(unit : mm)

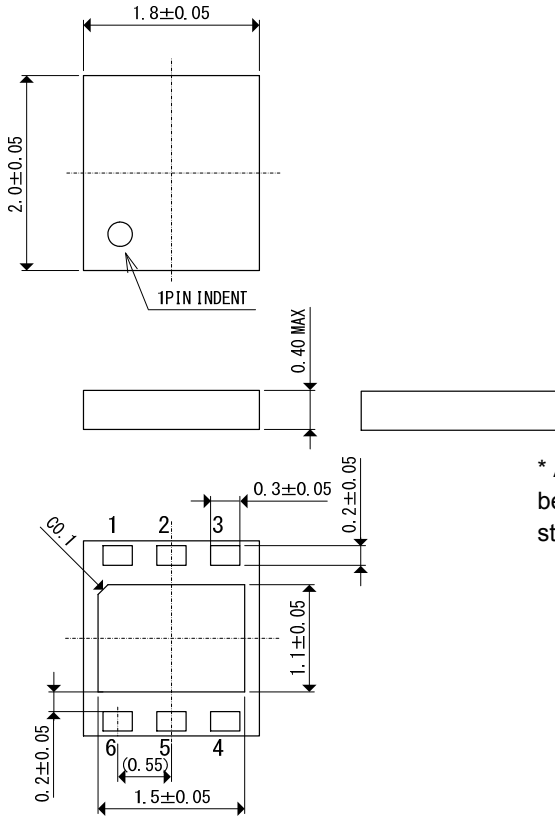

\* A part of the pin may appear from the side of the package because of it's structure, but reliability of the package and strength will not be changed below the standard.

● USP-6EL Reference Pattern Layout



● USP-6EL Reference Metal Mask Design

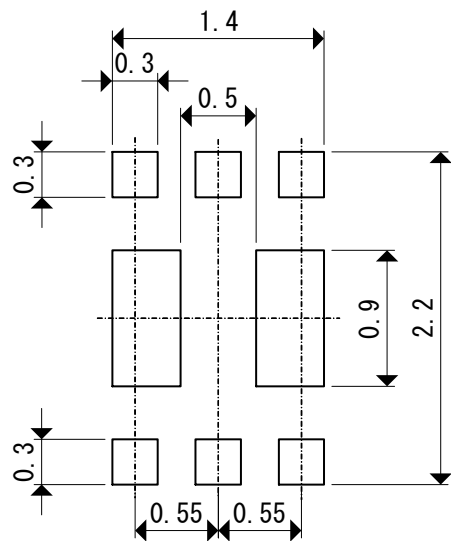

## PACKAGING INFORMATION (Continued)

### WLP-5-03

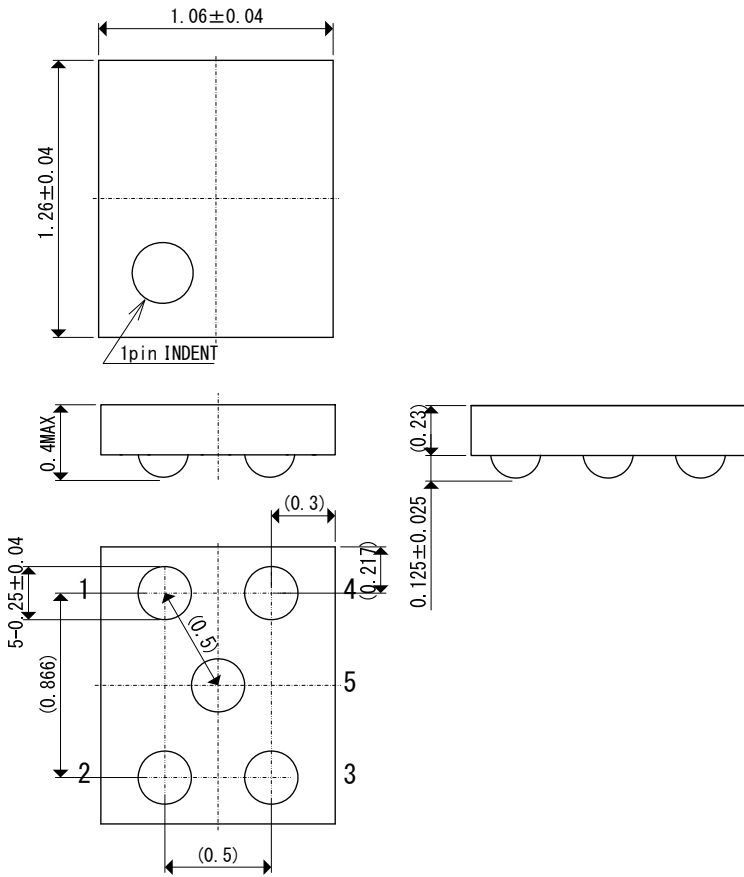

### WLP-5-03

Reference Pattern Layout

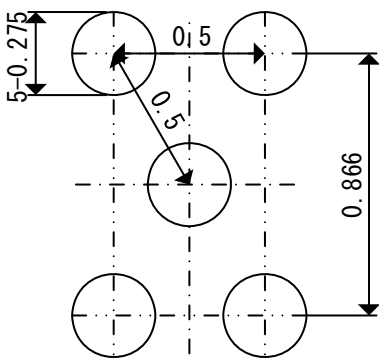

### WLP-5-03

Reference Pattern Layout detail

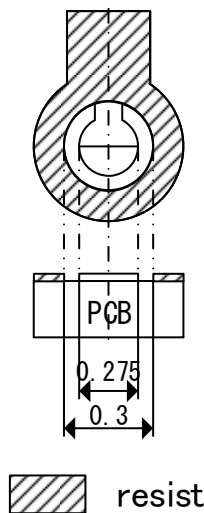

 resist

### WLP-5-03

Reference Metal Mask Design

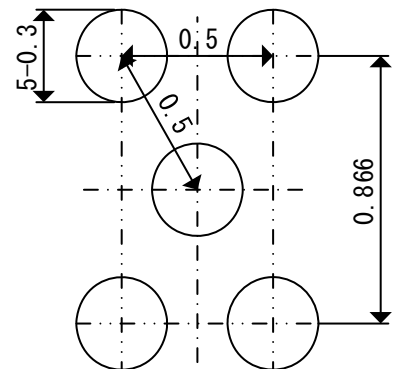

**● SOT-25 Power Dissipation**

Power dissipation data for the SOT-25 is shown in this page.

The value of power dissipation varies with the mount board conditions.

Please use this data as the reference data taken in the following condition.

**1. Measurement Condition**

Condition: Mount on a board

Ambient: Natural convection

Soldering: Lead (Pb) free

Board: Dimensions 40 x 40 mm

(1600 mm<sup>2</sup> in one side)

Copper (Cu) traces occupy 50% of the board

area in top and back faces

Package heat-sink is tied to the copper traces

(Board of SOT-26 is used.)

Material: Glass Epoxy (FR-4)

Thickness: 1.6mm

Through-hole: 4 x 0.8 Diameter

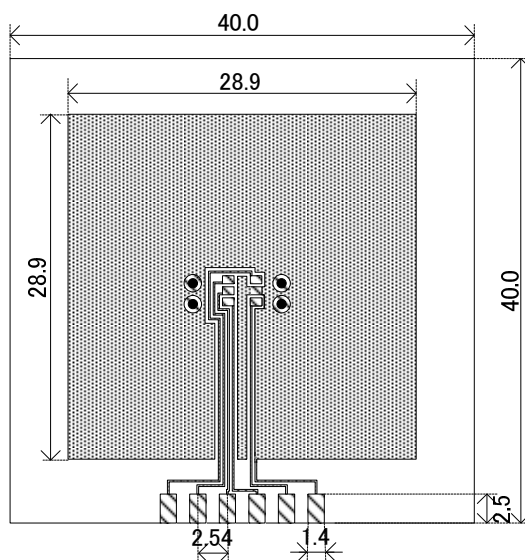

Evaluation Board (Unit: mm)

**2. Power Dissipation vs. Ambient Temperature**

Board Mount (Tj max = 125°C)

Ambient Temperature (°C)	Power Dissipation Pd (mW)	Thermal Resistance (°C/W)
25	600	166.67
85	240	

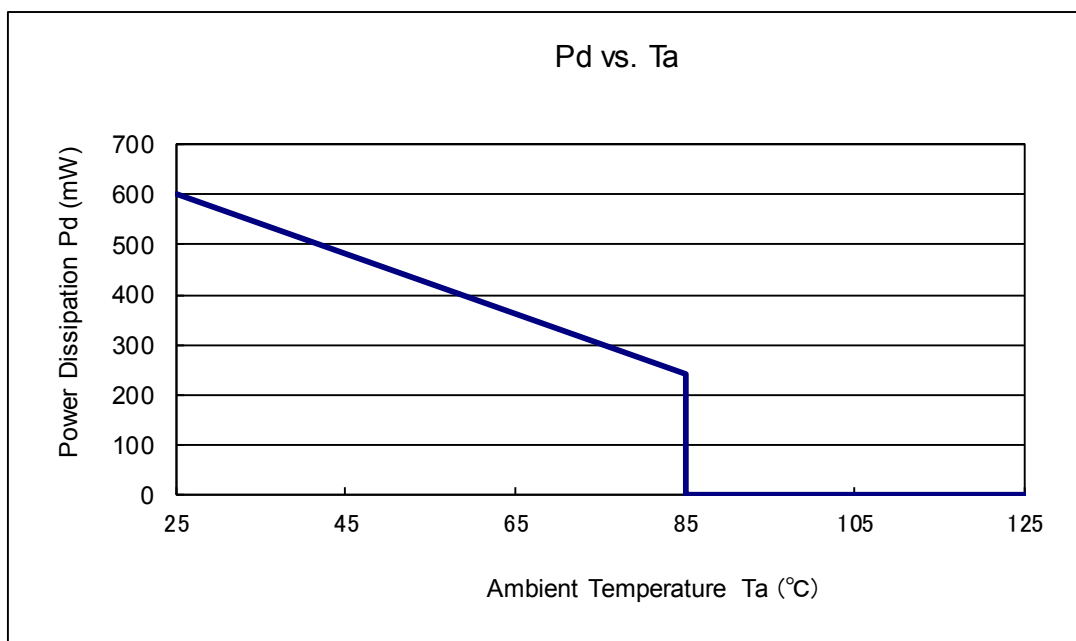

## ● USP-6C Power Dissipation

Power dissipation data for the USP-6C is shown in this page.

The value of power dissipation varies with the mount board conditions.

Please use this data as the reference data taken in the following condition.

### 1. Measurement Condition

- Condition : Mount on a board
- Ambient : Natural convection
- Soldering : Lead (Pb) free
- Board : Dimensions 40 x 40 mm  
(1600 mm<sup>2</sup> in one side)
- Copper (Cu) traces occupy 50% of the board area in top and back faces
- Package heat-sink is tied to the copper traces
- Material : Glass Epoxy (FR-4)
- Thickness : 1.6mm
- Through-hole : 4 x 0.8 Diameter



Evaluation Board (Unit : mm)

### 2. Power Dissipation vs. Ambient Temperature

Board Mount ( $T_j \text{ max} = 125^\circ\text{C}$ )

Ambient Temperature ( $^\circ\text{C}$ )	Power Dissipation $P_d$ (mW)	Thermal Resistance ( $^\circ\text{C}/\text{W}$ )
25	1000	100.00
85	400	

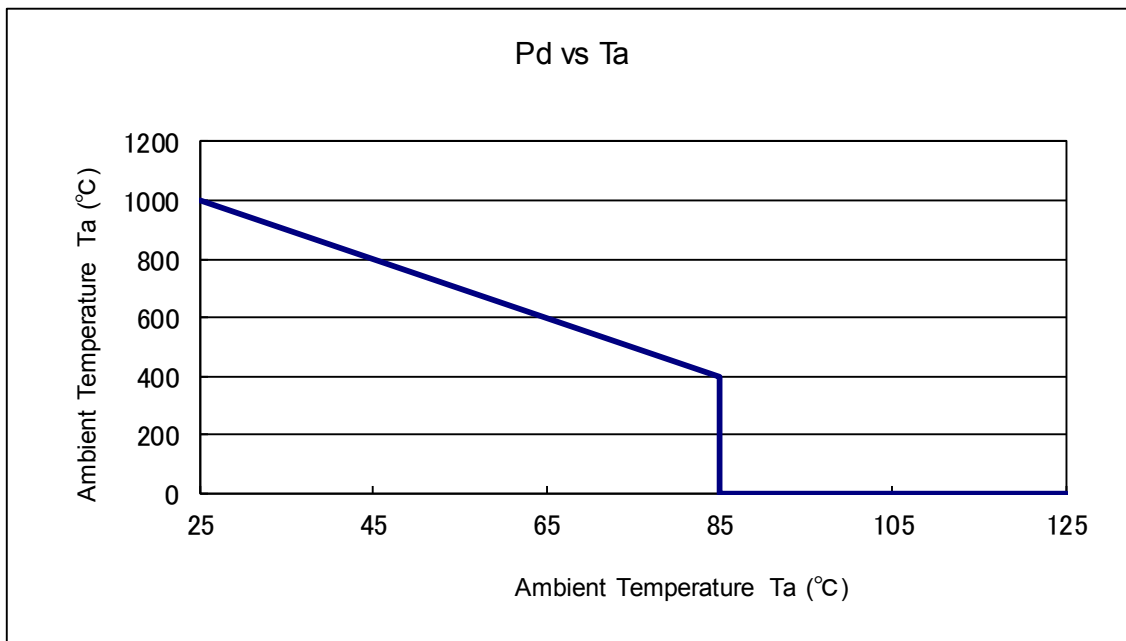

● **USP-6EL Power Dissipation**

Power dissipation data for the USP-6EL is shown in this page.  
The value of power dissipation varies with the mount board conditions.  
Please use this data as the reference data taken in the following condition.

1. Measurement Condition

- Condition : Mount on a board
- Ambient : Natural convection
- Soldering : Lead (Pb) free
- Board : Dimensions 40 x 40 mm  
(1600 mm<sup>2</sup> in one side)
- Copper (Cu) traces occupy 50% of the board area in top and back faces
- Package heat-sink is tied to the copper traces
- Material : Glass Epoxy (FR-4)
- Thickness : 1.6mm
- Through-hole : 4 x 0.8 Diameter



Evaluation Board (Unit : mm)

2. Power Dissipation vs. Ambient Temperature

Board Mount ( $T_j$  max = 125°C)

Ambient Temperature (°C)	Power Dissipation Pd (mW)	Thermal Resistance (°C/W)
25	1000	100.00
85	400	



## ● WLP-5 Power Dissipation

Power dissipation data for the WLP-5 is shown in this page.

The value of power dissipation varies with the mount board conditions.

Please use this data as the reference data taken in the following condition.

### 1. Measurement Condition

Condition: Mount on a board

Ambient: Natural convection

Soldering: Lead (Pb) free

Board: 40mm×40mm (1600mm<sup>2</sup> in one side)

1st Metal Layer about 50%

2nd Inner Metal Layer about 50%

3rd Inner Metal Layer about 50%

4th Metal Layer about 50%

4 separations is each layer connected to each pin

Material: Glass Epoxy (FR-4)

Thickness: 1.6mm

Through-hole: 4 x 0.8 Diameter



### 2. Power Dissipation vs. Ambient Temperature

Board Mount ( $T_j \text{ max} = 125^\circ\text{C}$ )

Ambient Temperature ( $^\circ\text{C}$ )	Power Dissipation $P_d$ (mW)	Thermal Resistance ( $^\circ\text{C}/\text{W}$ )
25	750	133.33
85	300	

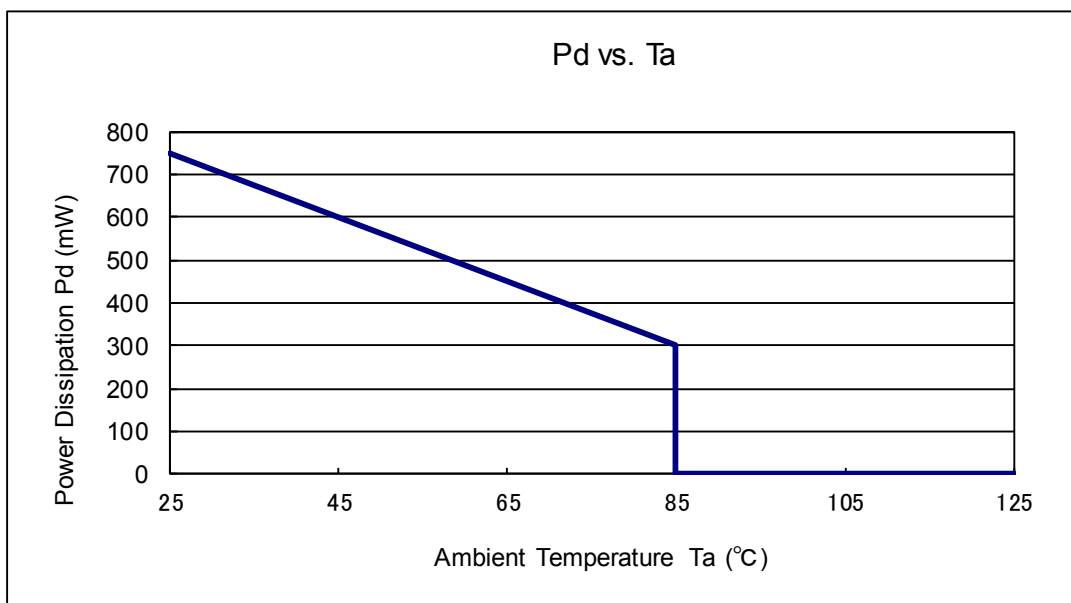

## MARKING RULE

### ●SOT-25



SOT-25  
(TOP VIEW)

### ●USP-6C/USP-6EL



USP-6C/USP-6EL  
(TOP VIEW)

### ●WLP-5-03



WLP-5-03  
(TOP VIEW)

① represents product series

PRODUCT SERIES	XC9235	XC9236	XC9237
A	4	5	6
B	C	D	E
C	K	L	M
D	K	L	M
E	4	5	6
F	2	7	B
G	C	D	E

② represents integer number of output voltage and oscillation frequency

#### ●A/B/C/F Series

OUTPUT VOLTAGE (V)	MARK	
	f <sub>osc</sub> =1.2MHz	f <sub>osc</sub> =3.0MHz
0.X	A	F
1.X	B	H
2.X	C	K
3.X	D	L
4.X	E	M

#### ●E/G/D Series

OUTPUT VOLTAGE (V)	MARK	
	f <sub>osc</sub> =1.2MHz	f <sub>osc</sub> =3.0MHz
0.X	N	U
1.X	P	V
2.X	R	X
3.X	S	Y
4.X	T	Z

③ represents decimal point of output voltage

V <sub>OUT</sub> (V)	MARK	V <sub>OUT</sub> (V)	MARK
X.00	0	X.05	A
X.10	1	X.15	B
X.20	2	X.25	C
X.30	3	X.35	D
X.40	4	X.45	E
X.50	5	X.55	F
X.60	6	X.65	H
X.70	7	X.75	K
X.80	8	X.85	L
X.90	9	X.95	M

④⑤ represents production lot number

Order of 01~09, 0A~0Z, 11~9Z, A1~A9, AA~AZ, B1~ZZ.

(G, I, J, O, Q, W excluded)



\*No character inversion used.

1. The product and product specifications contained herein are subject to change without notice to improve performance characteristics. Consult us, or our representatives before use, to confirm that the information in this datasheet is up to date.
2. The information in this datasheet is intended to illustrate the operation and characteristics of our products. We neither make warranties or representations with respect to the accuracy or completeness of the information contained in this datasheet nor grant any license to any intellectual property rights of ours or any third party concerning with the information in this datasheet.
3. Applicable export control laws and regulations should be complied and the procedures required by such laws and regulations should also be followed, when the product or any information contained in this datasheet is exported.
4. The product is neither intended nor warranted for use in equipment of systems which require extremely high levels of quality and/or reliability and/or a malfunction or failure which may cause loss of human life, bodily injury, serious property damage including but not limited to devices or equipment used in 1) nuclear facilities, 2) aerospace industry, 3) medical facilities, 4) automobile industry and other transportation industry and 5) safety devices and safety equipment to control combustions and explosions. Do not use the product for the above use unless agreed by us in writing in advance.
5. Although we make continuous efforts to improve the quality and reliability of our products; nevertheless Semiconductors are likely to fail with a certain probability. So in order to prevent personal injury and/or property damage resulting from such failure, customers are required to incorporate adequate safety measures in their designs, such as system fail safes, redundancy and fire prevention features.
6. Our products are not designed to be Radiation-resistant.
7. Please use the product listed in this datasheet within the specified ranges.
8. We assume no responsibility for damage or loss due to abnormal use.
9. All rights reserved. No part of this datasheet may be copied or reproduced unless agreed by Torex Semiconductor Ltd in writing in advance.

TOREX SEMICONDUCTOR LTD.

## Looking for pricing, stock, or lifecycle information?

Click below to explore more details on WIN SOURCE:

-  [View XC9235A18DMRN on WIN SOURCE](#)
-  [Torex Semiconductor Ltd Information](#)

## Optimize Your Supply Chain with WIN SOURCE Solutions

-  Global Sourcing Solution
-  Obsolete Management
-  Cost Control Management
-  Shortage Management
-  Alternative Solution
-  Excess Inventory Management