



**THE DATASHEET OF
ZDT6753TA**



100V COMPLEMENTARY MEDIUM POWER TRANSISTOR IN SM-8

Features

- NPN Transistor
 - $BV_{CEO} > 100$
 - $I_C = 2A$ High Continuous Current
 - Low Saturation Voltage $V_{CE(sat)} < 300mV @ 1A$
- PNP Transistor
 - $BV_{CEO} > -100V$
 - $I_C = -2A$ High Continuous Current
 - Low Saturation Voltage $V_{CE(sat)} < -300mV @ -1A$
- Lead-Free Finish; RoHS Compliant (Notes 1 & 2)
- Halogen and Antimony Free. "Green" Device (Note 3)
- Qualified to AEC-Q101 Standards for High Reliability

Mechanical Data

- Case: SM-8 (8 LEAD SOT223)
- Case Material: Molded Plastic, "Green" Molding Compound; UL Flammability Classification Rating 94V-0
- Moisture Sensitivity: Level 1 per J-STD-020
- Terminals: Finish - Matte Tin Plated Leads. Solderable per MIL-STD-202, Method 208 (Ⓢ)
- Weight: 0.117 grams (Approximate)

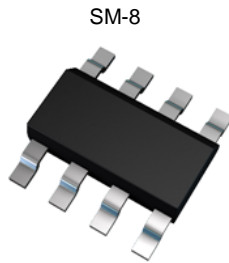

Top View

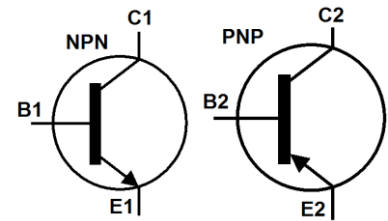
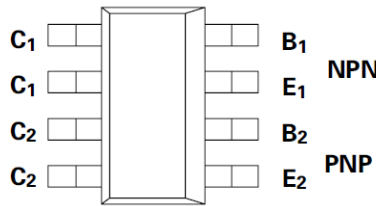

Ordering Information (Note 4)

Part Number	Marking	Reel size (inches)	Tape width (mm)	Quantity per reel
ZDT6753TA	T6753	7	12	1,000
ZDT6753TC	T6753	13	12	4,000

- Notes:
1. EU Directive 2002/95/EC (RoHS) & 2011/65/EU (RoHS 2) compliant. All applicable RoHS exemptions applied.
 2. See http://www.diodes.com/quality/lead_free.html for more information about Diodes Incorporated's definitions of Halogen- and Antimony-free, "Green" and Lead-free.
 3. Halogen- and Antimony-free "Green" products are defined as those which contain <900ppm bromine, <900ppm chlorine (<1500ppm total Br + Cl) and <1000ppm antimony compounds.
 4. For packaging details, go to our website at <http://www.diodes.com/products/packages.html>.

Marking Information

SM-8

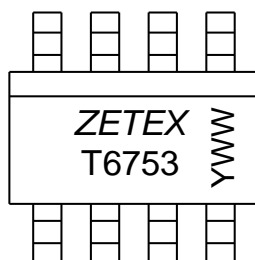

T6753 = Product Type Marking Code
 YWW = Date Code Marking
 Y or \bar{Y} = Last Digit of Year (ex: 5= 2015)
 WW or $\bar{W}W$ = Week Code (01~53)

Absolute Maximum Ratings (@T_A = +25°C, unless otherwise specified.)

Characteristic	Symbol	NPN	PNP	Unit
Collector-Base Voltage	V _{CBO}	120	-120	V
Collector-Emitter Voltage	V _{CEO}	100	-100	V
Emitter-Base Voltage	V _{EBO}	7	-7	V
Continuous Collector Current	I _C	2	-2	A
Peak Pulse Current (Note 5)	I _{CM}	6	-6	A

Thermal Characteristics (@T_A = +25°C, unless otherwise specified.)

Characteristic	Symbol	Value	Unit
Collector Power Dissipation	P _D	2.25	W
		2.75	
Thermal Resistance, Junction to Ambient	R _{θJA}	55.6	°C/W
		45.5	
Thermal Resistance, Junction to Leads	R _{θJL}	30.7	°C/W
Operating and Storage Temperature Range	T _J , T _{STG}	-55 to +150	°C

ESD Ratings (Note 8)

Characteristic	Symbol	Value	Unit	JEDEC Class
Electrostatic Discharge - Human Body Model	ESD HBM	4,000	V	3A
Electrostatic Discharge - Machine Model	ESD MM	400	V	C

- Notes:
- For a device with any single die active and mounted with the collector lead on 25mm x 25mm 2oz copper that is on a single-sided 1.6mm FR4 PCB; device is measured under still air conditions whilst operating in steady-state.
 - Same as Note 5, except both die are active and equally sharing power.
 - Thermal resistance from junction to solder-point (at the end of the collector lead).
 - Refer to JEDEC specification JESD22-A114 and JESD22-A115.

Thermal Characteristics and Derating Information

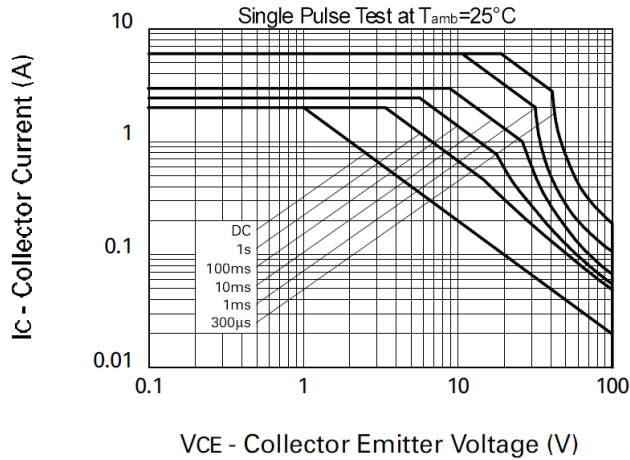

Safe Operating Area

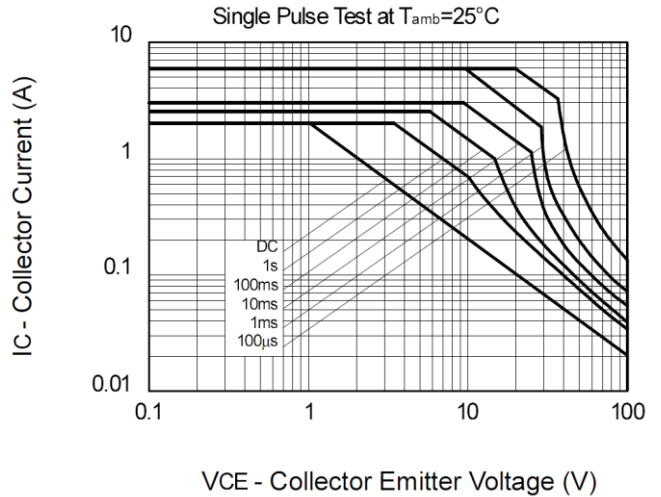

Safe Operating Area

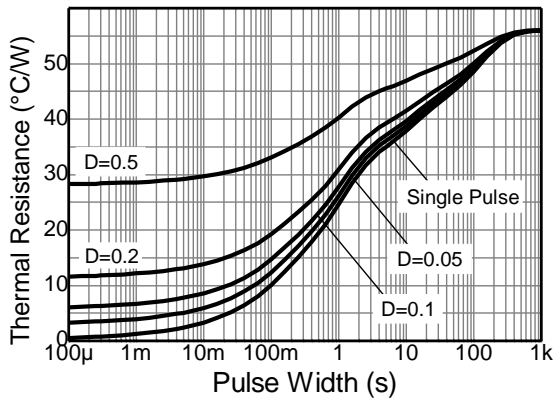

Transient Thermal Impedance

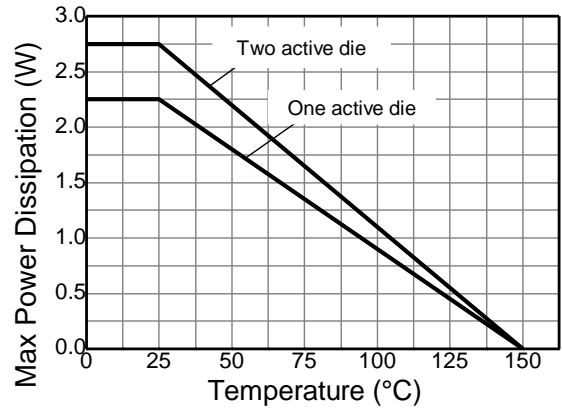

Derating Curve

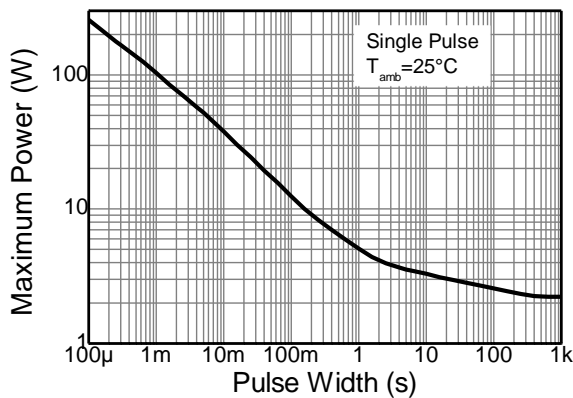

Pulse Power Dissipation

NPN - Electrical Characteristics (@T_A = +25°C, unless otherwise specified.)

Characteristic	Symbol	Min	Typ	Max	Unit	Test Condition
Collector-Base Breakdown Voltage	BV _{CBO}	120	—	—	V	I _C = 100μA
Collector-Emitter Breakdown Voltage (Note 9)	BV _{CEO}	100	—	—	V	I _C = 10mA
Emitter-Base Breakdown Voltage	BV _{EBO}	7	—	—	V	I _E = 100μA
Collector Cut-Off Current	I _{CBO}	—	< 1	0.1	μA	V _{CB} = 100V
		—	—	10	μA	V _{CB} = 100V, T _A = +125°C
Emitter Cut-Off Current	I _{EBO}	—	< 1	0.1	μA	V _{EB} = 5.6V
DC Current Transfer Static Ratio (Note 9)	h _{FE}	70	200	—	—	I _C = 50mA, V _{CE} = 2V
		100	200	300		I _C = 500mA, V _{CE} = 2V
		55	110	—		I _C = 1A, V _{CE} = 2V
		25	55	—		I _C = 2A, V _{CE} = 2V
Collector-Emitter Saturation Voltage (Note 9)	V _{CE(sat)}	—	0.13	0.30	V	I _C = 1A, I _B = 100mA
		—	0.23	0.50		I _C = 2A, I _B = 200mA
Base-Emitter Saturation Voltage (Note 9)	V _{BE(sat)}	—	0.9	1.25	V	I _C = 1A, I _B = 100mA
Base-Emitter Turn-on Voltage (Note 9)	V _{BE(on)}	—	0.8	1.0	V	I _C = 1A, V _{CE} = 2V
Transitional Frequency	f _T	140	175	—	MHz	I _C = 100mA, V _{CE} = 5V, f = 100MHz
Output Capacitance	C _{obo}	—	—	30	pF	V _{CB} = 10V, f = 1MHz
Switching Time	t _{on}	—	80	—	Ns	V _{CC} = 10V, I _C = 500mA, I _{B1} = -I _{B2} = 50mA
	t _{off}	—	1200	—	ns	

Note: 9. Measured under pulsed conditions. Pulse width ≤ 300μs. Duty cycle ≤ 2%.

NPN – Typical Electrical Characteristics (@ $T_A = +25^\circ\text{C}$, unless otherwise specified.)

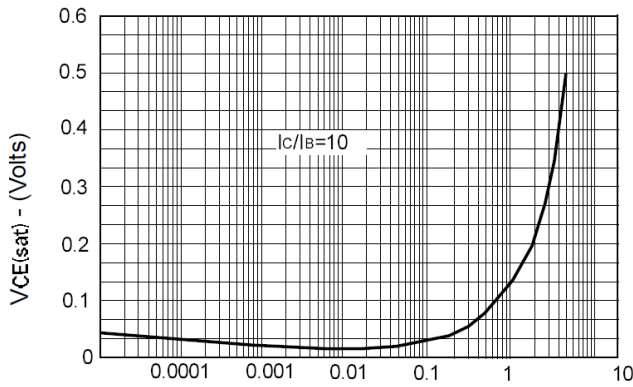

IC - Collector Current (Amps)

VCE(sat) v IC

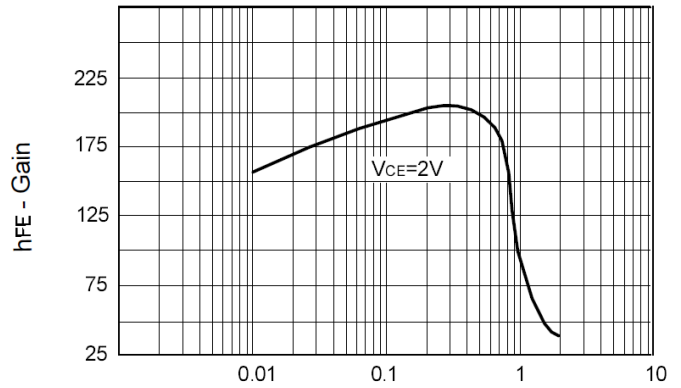

IC - Collector Current (Amps)

hFE v IC

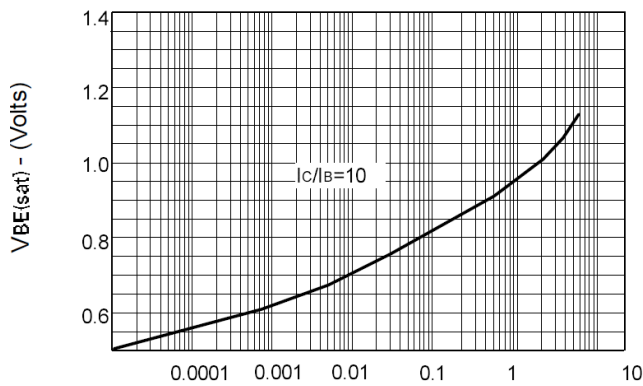

IC - Collector Current (Amps)

VBE(sat) v IC

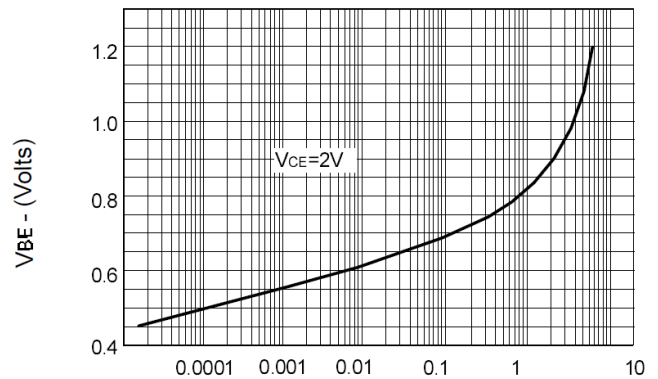

IC - Collector Current (Amps)

VBE(on) v IC

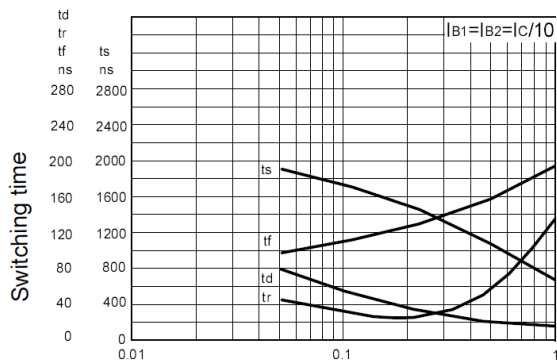

IC - Collector Current (Amps)

Switching Speeds

PNP - Electrical Characteristics (@T_A = +25°C, unless otherwise specified.)

Characteristic	Symbol	Min	Typ	Max	Unit	Test Condition
Collector-Base Breakdown Voltage	BV _{CBO}	-120	—	—	V	I _C = -100μA
Collector-Emitter Breakdown Voltage (Note 9)	BV _{CEO}	-100	—	—	V	I _C = -10mA
Emitter-Base Breakdown Voltage	BV _{EBO}	-7	—	—	V	I _E = -100μA
Collector Cut-Off Current	I _{CBO}	—	< 1	-0.1	μA	V _{CB} = -100V
		—	—	-10	μA	V _{CB} = -100V, T _A = +125°C
Emitter Cut-Off Current	I _{EBO}	—	< 1	-0.1	μA	V _{EB} = -5.6V
DC Current Transfer Static Ratio (Note 8)	h _{FE}	70	200	—	—	I _C = -50mA, V _{CE} = -2V
		100	200	300		I _C = -500mA, V _{CE} = -2V
		55	170	—		I _C = -1A, V _{CE} = -2V
		25	55	—		I _C = -2A, V _{CE} = -2V
Collector-Emitter Saturation Voltage (Note 9)	V _{CE(sat)}	—	-0.17	-0.30	V	I _C = -1A, I _B = -100mA
		—	-0.30	-0.50		I _C = -2A, I _B = -200mA
Base-Emitter Saturation Voltage (Note 9)	V _{BE(sat)}	—	-0.90	-1.25	V	I _C = -1A, I _B = -100mA
Base-Emitter Turn-On Voltage (Note 9)	V _{BE(on)}	—	-0.80	-1.0	V	I _C = -1A, V _{CE} = -2V
Transitional Frequency	f _T	100	140	—	MHz	I _C = -100mA, V _{CE} = -5V, f = 100MHz
Output Capacitance	C _{obo}	—	—	30	pF	V _{CB} = -10V, f = 1MHz,
Switching Time	t _{on}	—	35	—	ns	V _{CC} = -10V, I _C = -500mA, I _{B1} = -I _{B2} = -50mA
	t _{off}	—	600	—	ns	

Note: 9. Measured under pulsed conditions. Pulse width ≤ 300μs. Duty cycle ≤ 2%.

PNP – Typical Electrical Characteristics (@ $T_A = +25^\circ\text{C}$, unless otherwise specified.)

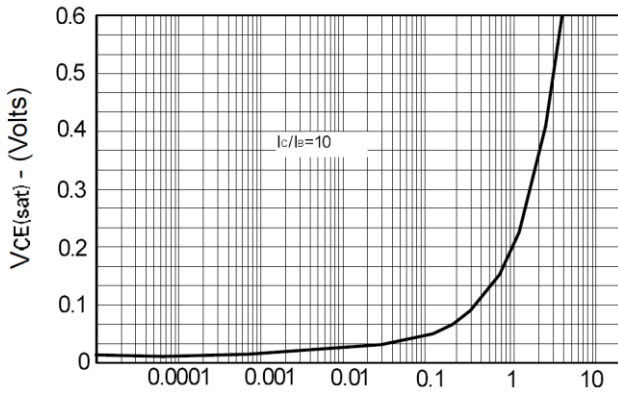

IC - Collector Current (Amps)

VCE(sat) v IC

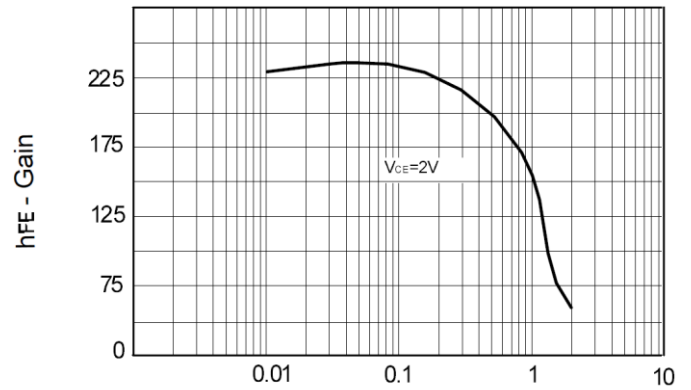

IC - Collector Current (Amps)

hFE v IC

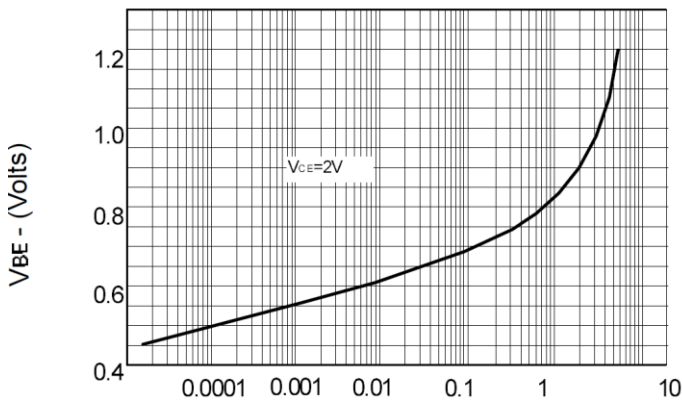

IC - Collector Current (Amps)

VBE(on) v IC

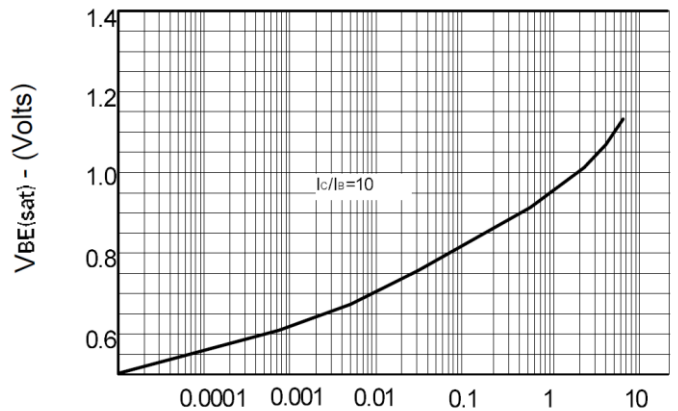

IC - Collector Current (Amps)

VBE(sat) v IC

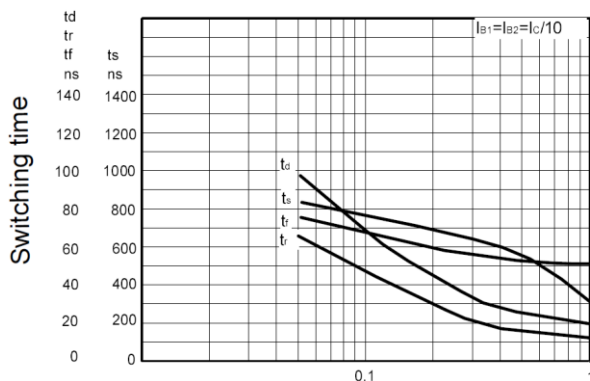

IC - Collector Current (Amps)

Switching Speeds

Package Outline Dimensions

Please see AP02002 at <http://www.diodes.com/datasheets/ap02002.pdf> for the latest version.

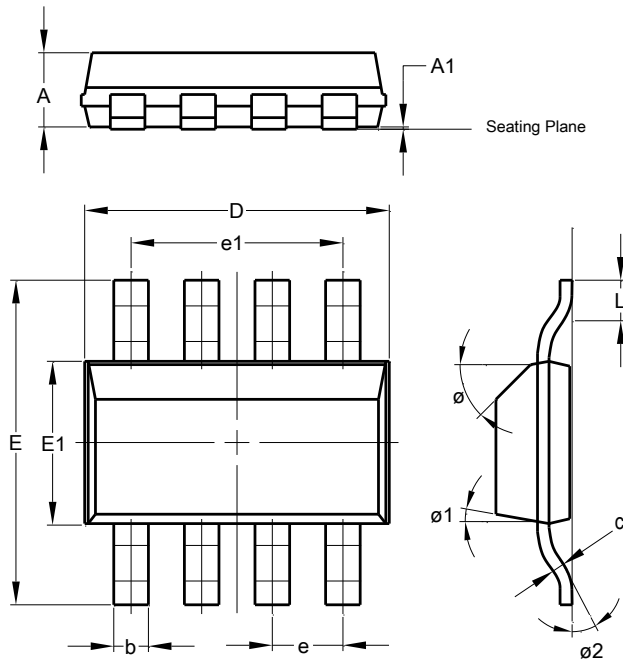

SM-8			
Dim	Min	Max	Typ
A	--	1.70	1.60
A1	0.02	0.10	0.04
b	0.70	0.90	0.80
c	0.24	0.32	0.28
D	6.30	6.70	6.60
e	1.53 REF		
e1	4.59 REF		
E	6.70	7.30	7.00
E1	3.30	3.70	3.50
L	0.75	1.00	0.90
ø	--	--	45°
ø1	--	15°	--
ø2	--	--	10°
All Dimensions in mm			

Suggested Pad Layout

Please see AP02001 at <http://www.diodes.com/datasheets/ap02001.pdf> for the latest version.

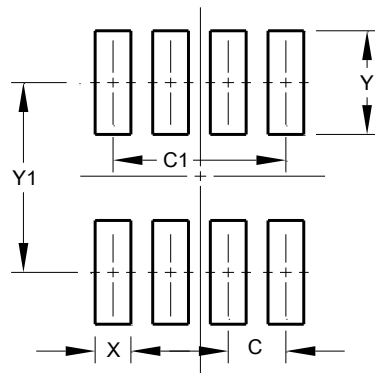

Dimensions	Value (in mm)
C	1.52
C1	4.6
X	0.95
Y	2.80
Y1	6.80

Note: For high voltage applications, the appropriate industry sector guidelines should be considered with regards to creepage and clearance distances between device terminals and PCB tracking.

IMPORTANT NOTICE

DIODES INCORPORATED MAKES NO WARRANTY OF ANY KIND, EXPRESS OR IMPLIED, WITH REGARDS TO THIS DOCUMENT, INCLUDING, BUT NOT LIMITED TO, THE IMPLIED WARRANTIES OF MERCHANTABILITY AND FITNESS FOR A PARTICULAR PURPOSE (AND THEIR EQUIVALENTS UNDER THE LAWS OF ANY JURISDICTION).

Diodes Incorporated and its subsidiaries reserve the right to make modifications, enhancements, improvements, corrections or other changes without further notice to this document and any product described herein. Diodes Incorporated does not assume any liability arising out of the application or use of this document or any product described herein; neither does Diodes Incorporated convey any license under its patent or trademark rights, nor the rights of others. Any Customer or user of this document or products described herein in such applications shall assume all risks of such use and will agree to hold Diodes Incorporated and all the companies whose products are represented on Diodes Incorporated website, harmless against all damages.

Diodes Incorporated does not warrant or accept any liability whatsoever in respect of any products purchased through unauthorized sales channel. Should Customers purchase or use Diodes Incorporated products for any unintended or unauthorized application, Customers shall indemnify and hold Diodes Incorporated and its representatives harmless against all claims, damages, expenses, and attorney fees arising out of, directly or indirectly, any claim of personal injury or death associated with such unintended or unauthorized application.

Products described herein may be covered by one or more United States, international or foreign patents pending. Product names and markings noted herein may also be covered by one or more United States, international or foreign trademarks.

LIFE SUPPORT

Diodes Incorporated products are specifically not authorized for use as critical components in life support devices or systems without the express written approval of the Chief Executive Officer of Diodes Incorporated. As used herein:

A. Life support devices or systems are devices or systems which:

1. are intended to implant into the body, or
2. support or sustain life and whose failure to perform when properly used in accordance with instructions for use provided in the labeling can be reasonably expected to result in significant injury to the user.

B. A critical component is any component in a life support device or system whose failure to perform can be reasonably expected to cause the failure of the life support device or to affect its safety or effectiveness.

Customers represent that they have all necessary expertise in the safety and regulatory ramifications of their life support devices or systems, and acknowledge and agree that they are solely responsible for all legal, regulatory and safety-related requirements concerning their products and any use of Diodes Incorporated products in such safety-critical, life support devices or systems, notwithstanding any devices- or systems-related information or support that may be provided by Diodes Incorporated. Further, Customers must fully indemnify Diodes Incorporated and its representatives against any damages arising out of the use of Diodes Incorporated products in such safety-critical, life support devices or systems.

Copyright © 2015, Diodes Incorporated

www.diodes.com

Looking for pricing, stock, or lifecycle information?

Click below to explore more details on WIN SOURCE:

 [View ZDT6753TA on WIN SOURCE](#)

 [Diodes Incorporated Information](#)

Optimize Your Supply Chain with WIN SOURCE Solutions

-  Global Sourcing Solution
-  Obsolete Management
-  Cost Control Management
-  Shortage Management
-  Alternative Solution
-  Excess Inventory Management