



**THE DATASHEET OF  
ZJYS5102-2PT**



# EMC Components

## Common Mode Choke Coils for Signal Line SMD

## ZJYS Series ZJYS51, ZJYS81 Types

### FEATURES

- A common mode filter for distortion-free noise removal from transmitted signals. Optimized for transmission of high quality signals.
- Best filter for countering the common mode noise resulting from data signal processing by PCs, phone equipment, etc.
- SMD-type designed for surface mounting.
- Due to a maximum current tolerance of 5A, can also be used to counter power line noise.
- The ZJYS81R5-2PL is a high inductance common mode filter designed to use with a CAN-BUS.
- The "T" designation at the end of the product code indicates tape mounting.

### APPLICATIONS

Personal computers, telephones, LANs, ISDNs, digital PBXs, electronic games, CTVs, CD-ROM drives, 8mm video equipment, and other electronic devices.

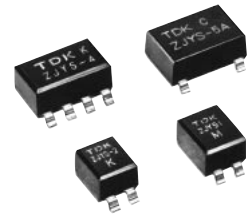

### SHAPES AND DIMENSIONS/RECOMMENDED PC BOARD PATTERNS

#### TRANSFER MOLD

#### ZJYS51R5-2P(T), -2PB(T), -2PL(T), 5103-2PL(T)

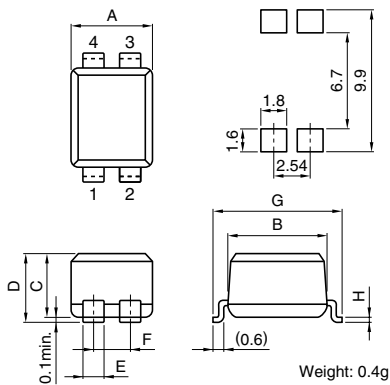

#### ZJYS51R5-4P(T), -M4PA(T)

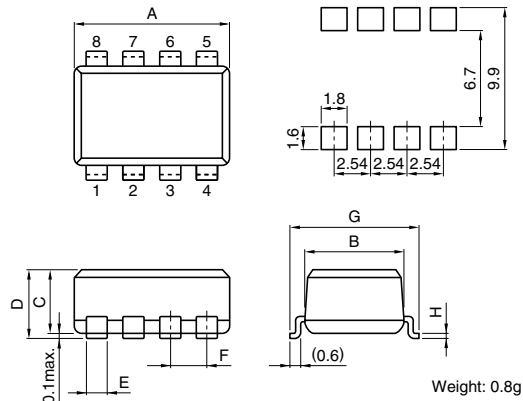

#### ZJYS5105-2PL(T)

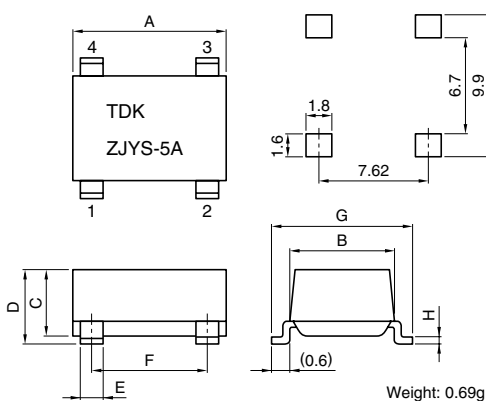

#### ZJYS81R5-2PL25(T)-G01, -2PL51(T)-G01

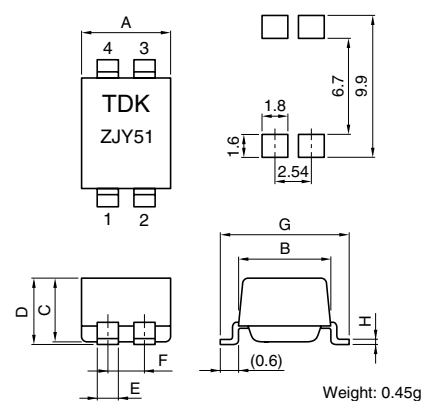

Dimensions in mm

Part No.	A max.	B max.	C max.	D max.	E	F	G max.	H
ZJYS51R5-2P(T), -2PB(T), -2PL(T), 5103-2PL(T)*	5.5	6.86	4.57	5.08	1.3	2.54±0.25	9±0.5	0.25
ZJYS51R5-4P(T), -M4PA(T)	10.5	6.86	4.57	5.08	1.3	2.54±0.25	9±0.5	0.25
ZJYS5105-2PL(T)	10.5	7.5	4.57	5.08	1.3	7.62±0.25	9±0.5	0.25
ZJYS81R5-2PL25(T)-G01, -2PL51(T)-G01	6	7.1	4.5	5	1.3	2.54±0.25	9±0.5	0.25

\* T means the taping product.

# EMC Components

## ZJYS Series ZJYS51, ZJYS81 Types

### Common Mode Choke Coils for Signal Line SMD

#### CIRCUIT DIAGRAMS

ZJYS51R5-2P(T),  
-2PB(T), -2PL(T)

ZJYS5103-2PL(T)

ZJYS81R5-2PL25(T)-G01

ZJYS81R5-2PL51(T)-G01

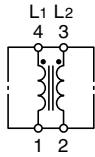

ZJYS51R5-4P(T)

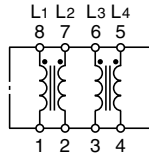

ZJYS51R5-M4PA(T)

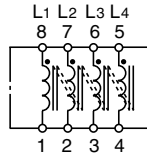

ZJYS5105-2PL(T)

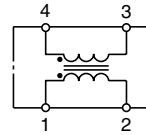

#### ELECTRICAL CHARACTERISTICS

Part No.	ZJYS51R5-2P(T), -2PB(T)*1, -2PL(T)*2, -4P(T)	ZJYS5103-2PL(T)	ZJYS51R5-M4PA(T)
Rated voltage Edc(V)	50	50	50
Rated current (A)	2	3	0.5
Test voltage Edc(V) [Between terminals for 5s]	125	125	125
Insulation resistance (MΩ) [Between terminals at DC.50V for 1min]	100min.	100min.	100min.
DC resistance (Ω) [Each line]	0.06max.	0.03max.	0.2max.
Operating temperature range (°C)	-25 to +85	-25 to +85	-25 to +85
Impedance (Ω) [+5 to +35°C]	200min.[20 to 300MHz]	100min.[100 to 300MHz]	200min.[20 to 300MHz]

Part No.	ZJYS5105-2PL(T)	ZJYS81R5-2PL25(T)-G01/-2PL51(T)-G01
Rated voltage Edc(V)	50	80
Rated current (A)	5	0.5
Test voltage Edc(V) [Between terminals for 5s]	125	200
Insulation resistance (MΩ) [Between terminals at DC.50V for 1min]	100min.	100min.
DC resistance (Ω) [Each line]	0.01max.	0.25/0.3max.
Operating temperature range (°C)	-25 to +85	-40 to +125
Impedance (Ω) [+5 to +35°C]	100min.[100 to 300MHz]	600min./1000min.[10 to 100MHz]

\*1 The characteristics of low area reform type.

\*2 Separate winding type (for communications).

• The "T" designation at the end of the product code indicates tape mounting.

#### TYPICAL ELECTRICAL CHARACTERISTICS

##### IMPEDANCE CHARACTERISTICS (for 1 element)

ZJYS51R5-2P, -4P

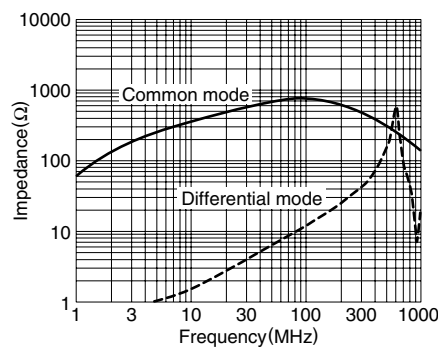

ZJYS51R5-2PB

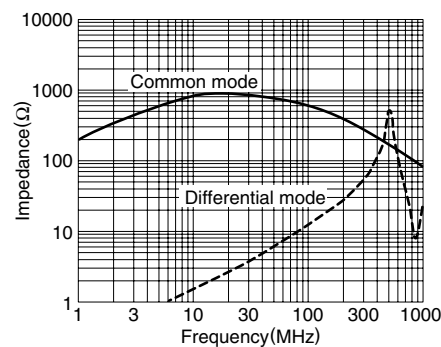

ZJYS51R5-2PL

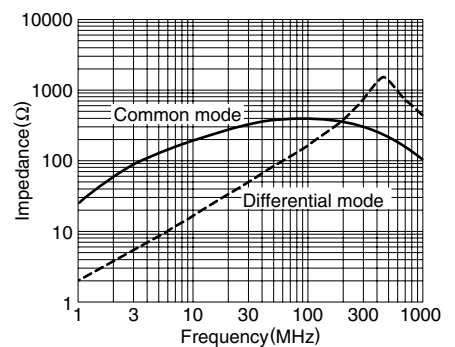

# EMC Components

## ZJYS Series ZJYS51, ZJYS81 Types

### Common Mode Choke Coils for Signal Line SMD

#### TYPICAL ELECTRICAL CHARACTERISTICS

##### IMPEDANCE CHARACTERISTICS (for 1 element)

###### ZJYS5103-2PL

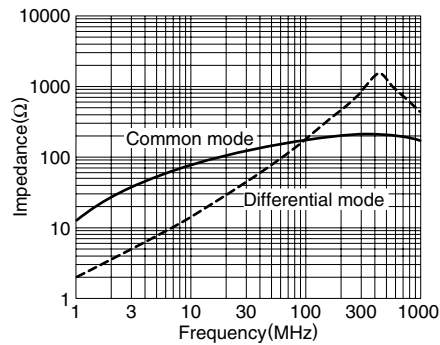

###### ZJYS5105-2PL

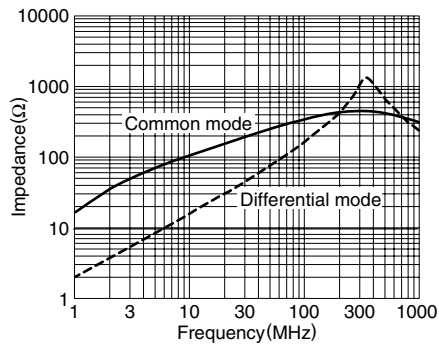

###### ZJYS51R5-M4PA

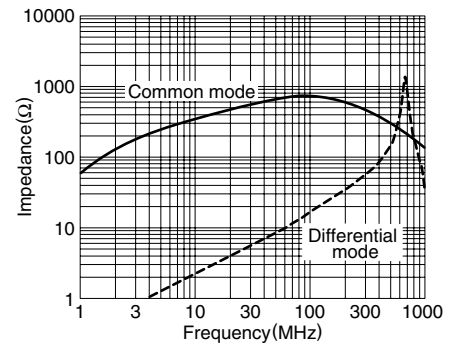

###### ZJYS81R5-2PL25-G01

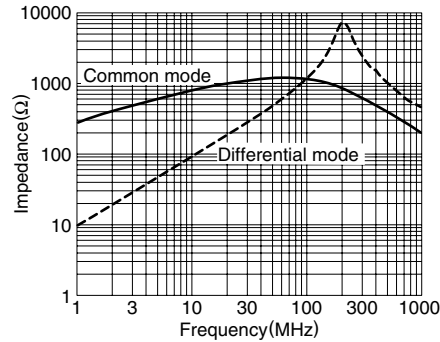

###### ZJYS81R5-2PL51-G01

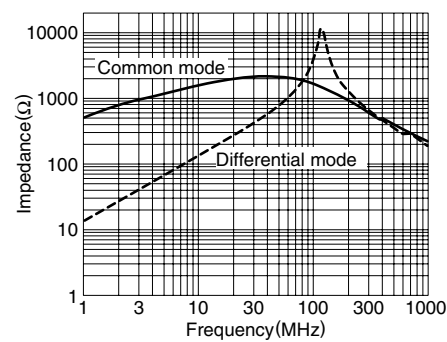

#### MEASURING CIRCUIT

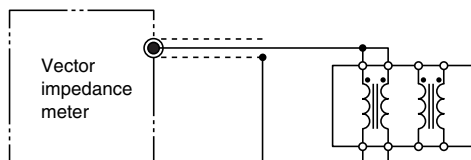

Vector impedance meter (YHP 4191A equivalent)  
Measuring at each Common mode choke coil

#### PACKAGING STYLE AND QUANTITIES

Part No.	Taping (/reel)	Bulk
ZJYS51R5-2P(T)	1500 pieces	200 pieces
ZJYS51R5-2PB(T)	1500 pieces	200 pieces
ZJYS51R5-2PL(T)	1500 pieces	200 pieces
ZJYS5103-2PL(T)	1500 pieces	200 pieces
ZJYS81R5-2PL25(T)-G01	1500 pieces	200 pieces
ZJYS81R5-2PL51(T)-G01	1500 pieces	200 pieces
ZJYS51R5-4P(T)	1000 pieces	100 pieces
ZJYS51R5-M4PA(T)	1000 pieces	100 pieces
ZJYS5105-2PL(T)	1000 pieces	100 pieces

# EMC Components

ZJYS Series ZJYS51, ZJYS81 Types

## Common Mode Choke Coils for Signal Line SMD

### TYPICAL APPLICATION

An application example showing how radiation noise is prevented when transmitter and receiver are connected via twisted pair cabling.

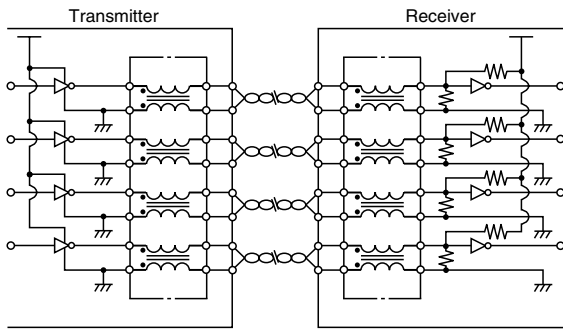

### TYPICAL APPLICATION EFFECTS

#### (a) Without EMC filter

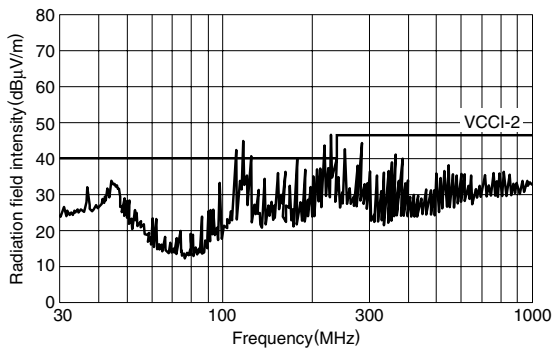

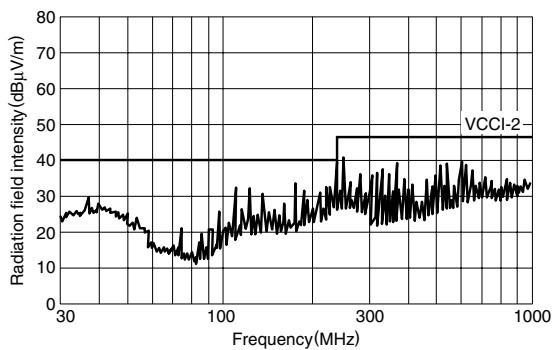

#### (b) With EMC filter ZJYS51R5-2P(T), 4P(T)



## Looking for pricing, stock, or lifecycle information?

Click below to explore more details on WIN SOURCE:

-  [View ZJYS5102-2PT](#) on WIN SOURCE
-  [TDK Corporation](#) Information

## Optimize Your Supply Chain with WIN SOURCE Solutions

-  Global Sourcing Solution
-  Obsolete Management
-  Cost Control Management
-  Shortage Management
-  Alternative Solution
-  Excess Inventory Management