

5.0 VOLT ULTRA LOW DROPOUT REGULATOR

ISSUE 2 - JULY 1997

ZLDO500

DEVICE DESCRIPTION

The ZLDO Series low dropout linear regulators operate with an exceptionally low dropout voltage, typically only 30mV with a load current of 100mA. The regulator series features output voltages in the range 2.7 to 18 volts, this device provides an output voltage of 5.0 volts.

The ZLDO500 consumes a typical quiescent current of only 1mA at its maximum rated output current of 300mA. A battery low flag is available to indicate potential power fail situations. If the input voltage falls to within 200mV of the regulated output voltage then the error output pulls low. The device also features an active high disable control. Once disabled the ZLDO quiescent current falls to typically 11 μ A.

The ZLDO devices are packaged in Zetex SM8 8 pin small outline surface mount package, ideal for applications where space saving is important. The device low dropout voltage, low quiescent current and small size make it ideal for low power and battery powered applications. Battery powered circuits can make particular use of the low battery flag and shutdown features.

FEATURES

- Very low dropout voltage
- 6mV dropout at 10mA output
- 30mV dropout at 100mA output
- 100mV dropout at 300mA output
- 5.0 volt fixed output
- Other voltages available
- Low quiescent current
- 1mA quiescent at 300mA output
- Low battery flag
- Shutdown control
- Surface mount package

APPLICATIONS

- Battery powered devices
- Portable instruments
- Portable communications
- Laptop/Palmtop computers
- Electronic organisers

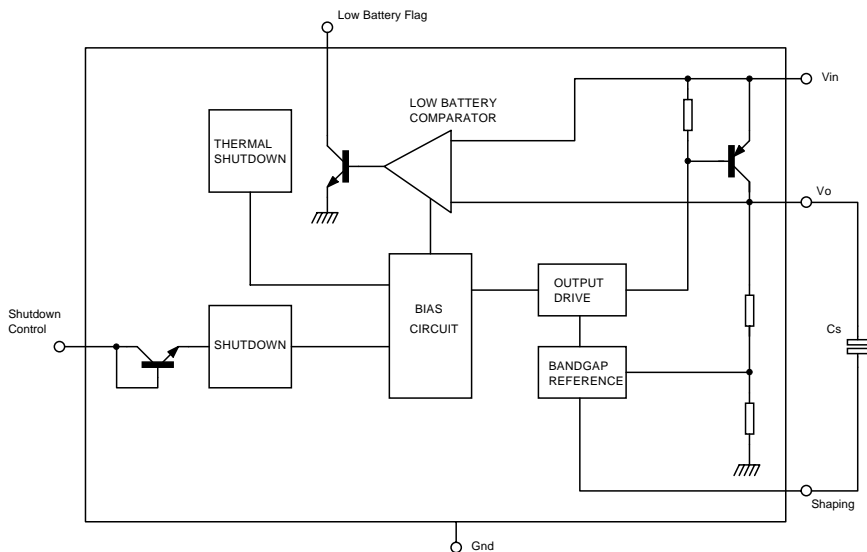

ZLDO500

ABSOLUTE MAXIMUM RATING

Input Supply Voltage Range	-0.3 to 20V	Output Current	300mA
Shutdown Input Voltage Range	-0.3 to V_{in}	Operating Temperature	-40 to 85°C
Low Battery Output Voltage Range	-0.3 to 20V	Storage Temperature	-55 to 150°C
		Power Dissipation ($T_{amb}=25^{\circ}C$)	2W (Note 1)

ELECTRICAL CHARACTERISTICS

TEST CONDITIONS (Unless otherwise stated) $T_{amb}=25^{\circ}C, I_L=10mA, C_s=10pF, C_{out}=1\mu F$

Parameter	SYMBOL	CONDITIONS	MIN	TYP	MAX	UNITS
Output voltage	V_o	$V_{in}=6.0V$	4.9	5.0	5.1	V
Output voltage temperature coefficient	$\frac{V_o}{\Delta T}$	$V_{in}=6.0V$ (Note 2, Note 4)		100	250	ppm/°C
Line regulation	ΔV_o	$V_{in}=6.0$ to 20V		20	70	mV
Load regulation	ΔV_o	$I_L=10$ to 300mA $V_{in}=6V$		70	123	mV
Dropout voltage (Note3)	$V_{in}-V_o$	$I_L=10mA$ $I_L=100mA$ $I_L=300mA$		6 30 100	10 75 200	mV
Quiescent current	I_q	$V_{in}=6.0V, I_L=0$		0.63	1	mA
Quiescent current at shutdown	I_{qs}	$V_{in}=6.0V, I_L=0,$ $V_{shdn}=V_{in}$		11	30	μA
Shutdown control input current	I_{ins}	$V_{shdn}=V_{in}=6.0V$		2	10	μA
Shutdown control threshold voltage	V_{ts}	$V_{in}=6.0V$ low(on) high(off)	1.5		0.4	V
Output current in shutdown mode (Note4)	I_{Ls}	$V_{in}=20V$ $V_o=Gnd$		50	100	nA
Output noise voltage (Note4)	e_n	$V_{in}=6.0V$ $f=10Hz$ to 100kHz, $I_L=100mA$		190		μV RMS
Low battery detect voltage	$V_{in(bld)}$		$V_o + 0.2V$		$V_o + 0.4V$	V
Low battery flag output voltage	V_{bl}	$I_{bl}=100\mu A,$ $V_{in}<V_o+200mV$		0.16	0.4	V
Low battery flag leakage current	I_{bl}	$V_{bl}=6V,$ $V_{in}>V_o+400mV$		0.1	1	μA

ZLDO500

NOTES.

1. Maximum power dissipation of the device is calculated assuming the package is mounted on a PCB measuring 2 inches square.

2 Output voltage temperature coefficient is calculated as:-
$$\frac{V_O \text{ change} \times 1000000}{V_O \times \text{temperature change}}$$

3. Dropout voltage is defined as the input to output voltage differential at which the circuit ceases to regulate. The value is measured when the output voltage has dropped by 100mV from V_{out} measured at the nominal input $V_{in} = V_{out} + 1V$

4. Guaranteed by design.

FUNCTIONAL DESCRIPTION

The ZLDO is a high performance, ultra low dropout, low quiescent regulator. Available in SM8 surface mount packaging, the device is able to dissipate 2W(note 1) allowing complete design flexibility with an input span upto 20V and 300mA output current. The device quiescent is 1mA (typ) at 300mA load current. A low battery comparator signifies

impending battery failure, whilst a shutdown function reduces quiescent current to a mere 11 μ A (typ). A precision bandgap reference gives $\pm 2.5\%$ output tolerance and good temperature characteristics over the range -40 to +85°C. AC performance is enhanced via the use of a small external capacitor.

PIN DEFINITIONS

Pin 1 LBF - Low Battery Flag. An open collector NPN output which pulls low on failing input supply.

Pin 2 SC - Shutdown Control. This high impedance logic compatible input disables the regulator when taken high. It includes a diode wired to V_{in} and so will pass current if taken more than 0.5V above V_{in} .

Pin 3 V_{in} - Voltage Input. The power supply to the regulator. The permissible input voltage range is -0.3 to 20V. An input capacitor is not mandatory but will be useful in reducing the coupling of noise from input to output and minimising the effect of sudden changes in load current on the input voltage.

Pin 4 N/C - Not Connected. Not internally connected and so can be left open or wired to any pin without affecting the performance of the regulator.

Pin 5 V_{out} - Voltage Output. The output of the regulator. An output capacitor of 1 μ F or greater and having low ESR should be wired in close proximity to the regulator to ensure stability for all loads.

Pin 6 D/C - Do Not Connect. This pin is wired to an internal circuit node of the regulator. No external connection should be made to this pin.

Pin 7 Gnd - Ground. The ground connection of the regulator against which the output voltage is referenced.

Pin 8 Spg - Shaping. The shaping node for the error amplifier of the regulator. A capacitor of 10pF wired from this pin to the output pin (pin 5) gives optimum stability. Improved AC can be achieved by reducing the value of this capacitor but stability may be impaired for some load conditions.

ZLDO500

TYPICAL CHARACTERISTICS

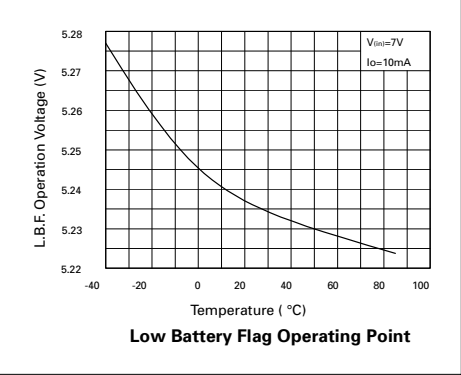
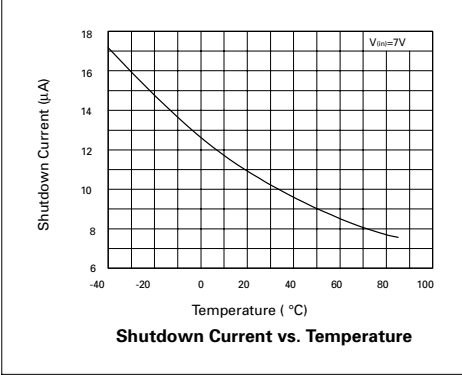
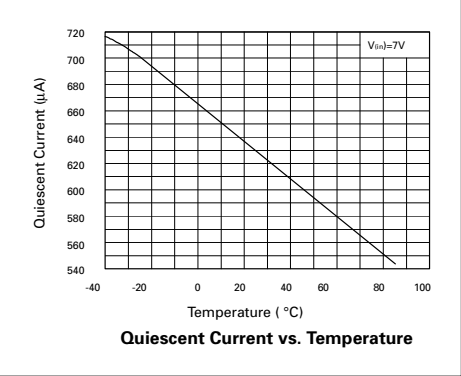
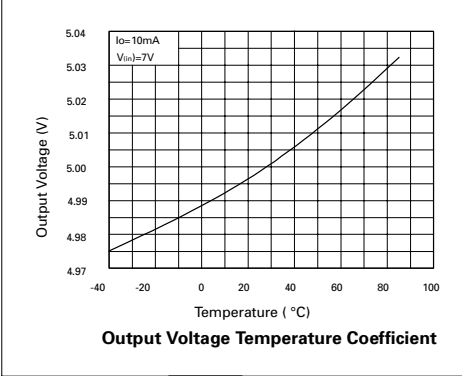
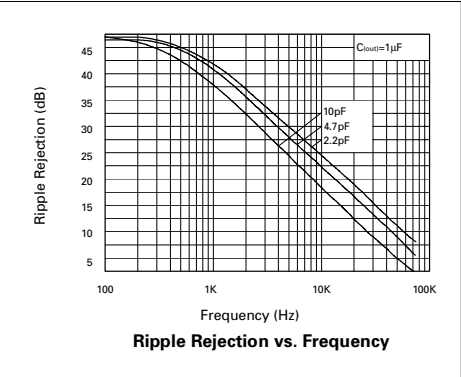
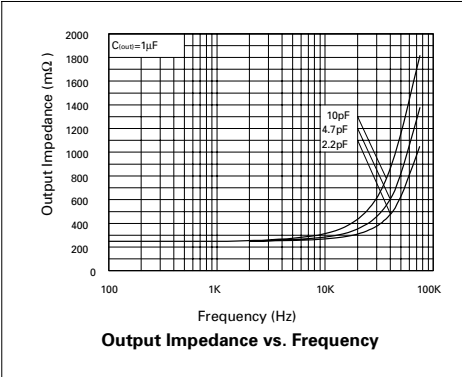

ZLDO500

TYPICAL CHARACTERISTICS

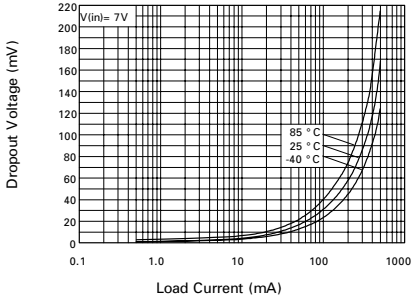

Dropout Voltage vs. Load Current

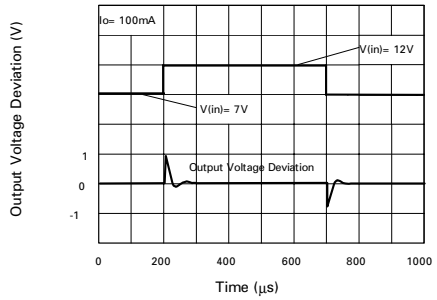

Line Transient Response

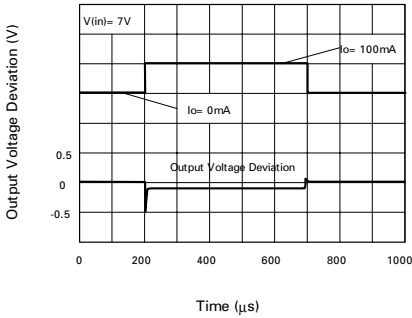

Load Transient Response

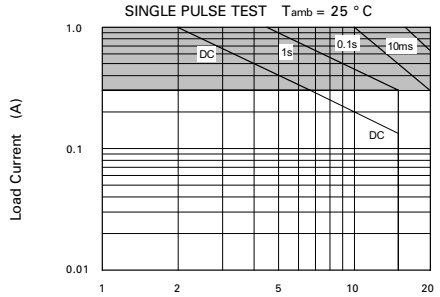

Input-Output Differential Voltage (V)

Safe Operating Area

Operation in shaded area is not guaranteed

ZLDO500

APPLICATIONS

1). Operation From A Low Voltage Battery Pack

Fig.1 shows the ZLDO500 regulator being used to stabilise the output of a 6V battery pack. The ultra low dropout voltage of only 100mV at full load (300mA) given by the regulator allows the minimum number of cells to be used in the pack and also maximises the energy that can be removed from the battery before the output of the

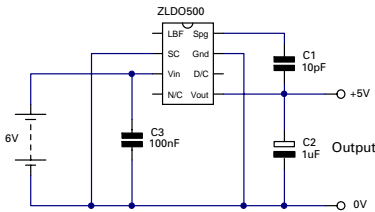

Figure 1

regulator starts to fail.

At a load current of 100mA the dropout voltage falls to around 30mV. The endurance of the battery pack is not only dependent on dropout voltage. When operating, some low dropout regulators can consume high quiescent currents, sometimes approaching as much as a tenth of their maximum load current specification when approaching

dropout conditions. Despite its 300mA output rating, when enabled the ZLDO500 consumes typically only 630uA regulating normally and 3mA when the input falls too low for regulation.

2). Post Converter Regulation

A common problem with multiple output switch mode converters is that only one output can be used in the feedback control loop of the switching regulator. Thus only one output is fully regulated. All other outputs are prone to tracking errors that occur if the load on any output change significantly. By ensuring close coupling of all transformer windings and minimising the impedance of all outputs, these errors can be reduced but never eliminated. A simple way round this problem is to wind the switching regulator transformer to give a slightly higher voltage than required and regulate down from this to the desired voltage with a linear regulator. This is indicated in Figure 2. To keep losses low and so maintain the advantages of a switch mode supply, it is important that the voltage drop across this regulator is kept as low as possible, i.e. just high enough to compensate for the poor output impedance of the switching power supply but no higher. The low dropout

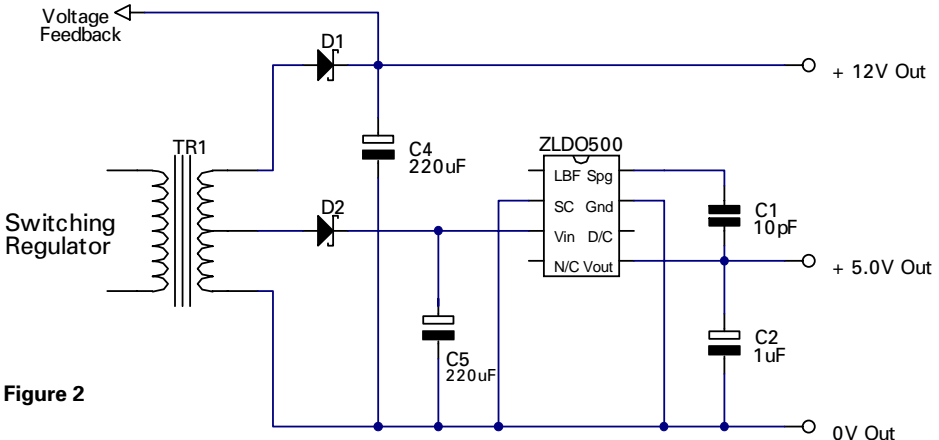

Figure 2

ZLDO500

APPLICATIONS

voltage of the ZLDO500 allows this circuit technique to be implemented very effectively, giving a highly stable and accurate low noise supply.

3). Logic Controlled Power Supply

Figure 3 shows all that is necessary to allow a microprocessor to control a power supply based on the ZLDO500. The Shutdown Control pin (pin 2), is a logic compatible input that disables the regulator when a voltage in

be taken to a voltage higher than V_{in} if low quiescent supply current is important. The shutdown control is a high impedance input and so if not required, should be wired to the ground pin (pin 7).

4). Over Temperature Shutdown

The ZLDO500 regulator includes an over temperature shutdown circuit that disables the regulator if its chip temperature should exceed 125°C for any reason. Although

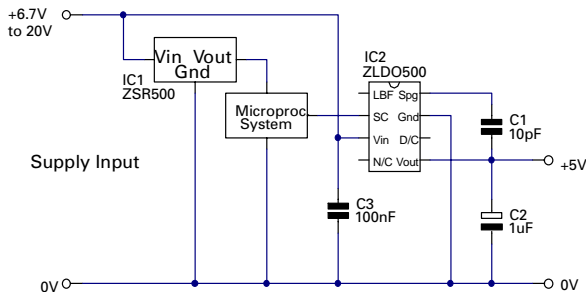

Figure 3

excess of 1.5V is applied. The current required to drive this input is less than $10\mu\text{A}$. When the regulator is shutdown in this way, the quiescent current of the ZLDO500 falls to around $11\mu\text{A}$. This makes the regulator suitable for a wide range of battery powered applications where intermittent operation occurs. The shutdown control pin should not

intended to provide a limited guard against excessive internal power dissipation, this circuit will shut down the regulator if its ambient rises above 125°C . Thus, the regulator could be used to disable a circuit in the event of the ambient temperature within which the circuit is mounted becoming too high. Any internal power dissipation caused as a result of supplying load current, will reduce the ambient temperature at which shutdown occurs. Note that to achieve the extremely low dropout voltage and high current performance provided by the

ZLDO500

APPLICATIONS

ZLDO500 devices, the parts can be damaged by sustained output shorts or excessive loads when combined with high input supply voltages. To ensure reliable operation, keep loads within the SOA graph boundaries indicated in the typical characteristics.

5). Low Battery Flag

The ZLDO500 provides an output called Low Battery Flag (LBF). Unlike many regulators

that only signal that they are falling out of regulation, the LBF output of the ZLDO500 series indicates that the voltage drop across the regulator has fallen to less than typically 300mV and so supply failure is imminent.

This improved warning gives both more time for the system supplied to shutdown gracefully and maintains regulation while this happens. This could be a vital point if measurements are under way and must be

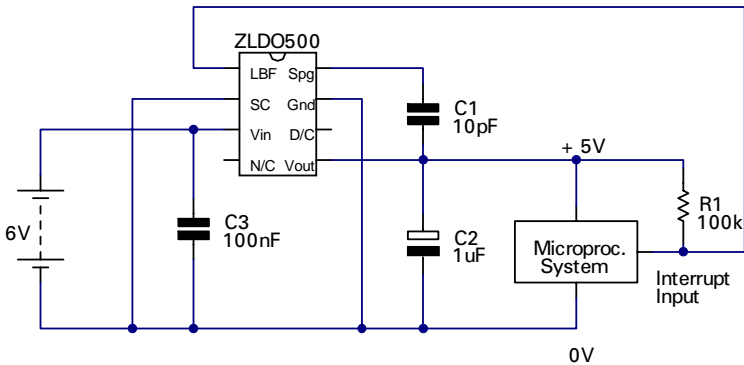

Figure 4

ZLDO500

CONNECTION DIAGRAM

SM8 Package Suffix – T8



Top View –
Pin 6 must be left floating
SEE PIN DEFINITIONS

ORDERING INFORMATION







Part Number	Package	Part Mark
ZLDO500T8	SM8	ZLDO500

Looking for pricing, stock, or lifecycle information?

Click below to explore more details on WIN SOURCE:

-  View [ZLDO500T8TA](#) on WIN SOURCE
-  [Diodes Incorporated](#) Information

Optimize Your Supply Chain with WIN SOURCE Sol

-  Global Sourcing Solution
-  Obsolete Management
-  Cost Control Management
-  Shortage Management
-  Alternative Solution
-  Excess Inventory Management