



# THE DATASHEET OF ZPDR-12V-S





# ZPD CONNECTOR

1.5mm pitch/Disconnectable Crimp style connectors

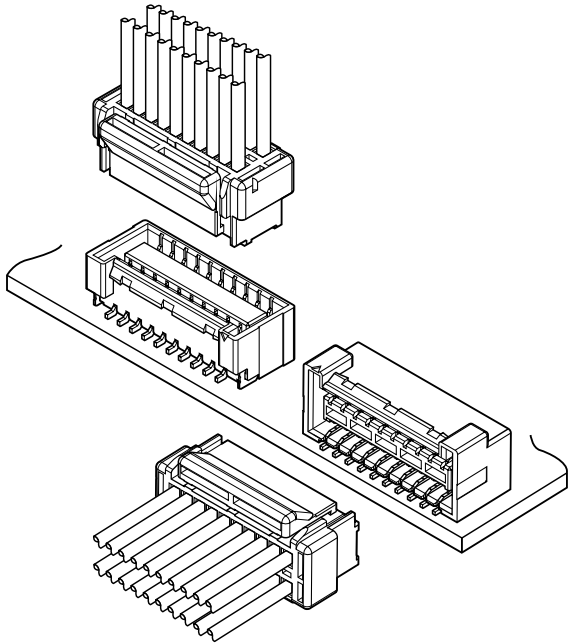

In order to correspond to the high-density PC board designing, this ZPD connector is designed as 1.5mm pitch double row type connector with secure locking device. Low insertion force is realized and good mating feeling is also prepared, and these provide the certain mating operation.

- Secure locking structure
- Low insertion force
- Suction area for picking up
- Improvement of engagement with prying

## Specifications

- Current rating: 2A AC, DC (AWG #24)
- Voltage rating: 100V AC, DC
- Temperature range: -25°C to +85°C  
(including temperature rise in applying electrical current)
- Contact resistance: Initial value/30m Ω max.  
After environmental testing/60m Ω max.
- Insulation resistance: 500M Ω min.
- Withstanding voltage: 500V AC/minute
- Applicable wire: Conductor size/AWG #28 to #24  
Insulation O.D./0.8 to 1.2mm
- \* Compliant with RoHS.
- \* Refer to "General Instruction and Notice when using Terminals and Connectors" at the end of this catalog.
- \* Contact JST for details.

## PC board layout (viewed from component side) and Assembly layout

### Top entry type

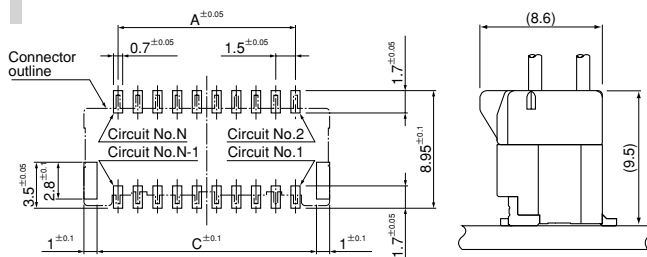

### Side entry type

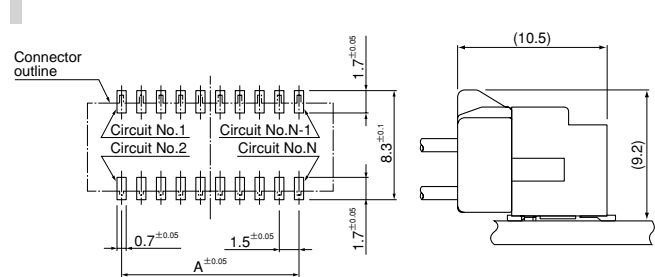

Note: 1. Tolerances are non-cumulative: ±0.05mm for all centers.  
2. The dimensions above should serve as a guideline. Contact JST for details.

## Contact

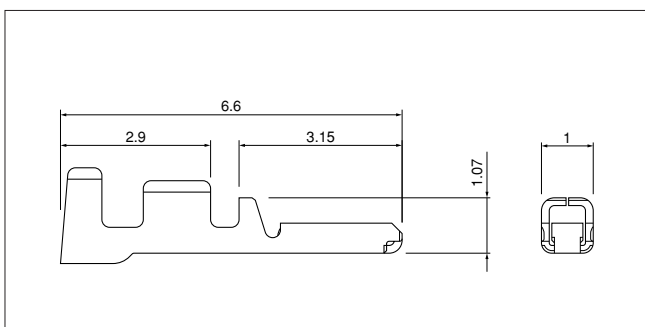

Model No.	Applicable wire		Insulation O.D. (mm)	Q'ty / reel
	mm <sup>2</sup>	AWG#		
SZPD-002T-P0.3	0.08~0.21	28~24	0.8~1.2	16,000

### Material and Finish

Copper alloy, tin-plated (reflow treatment)

### RoHS compliance

Contact	Crimping machine	Applicator		
		Crimp applicator	Dies	Crimp applicator with dies
SZPD-002T-P0.3	AP-K2N	MKS-L	MK/SZE-002-03	APLMK SZE002-03

# ZPDR CONNECTOR

## Housing

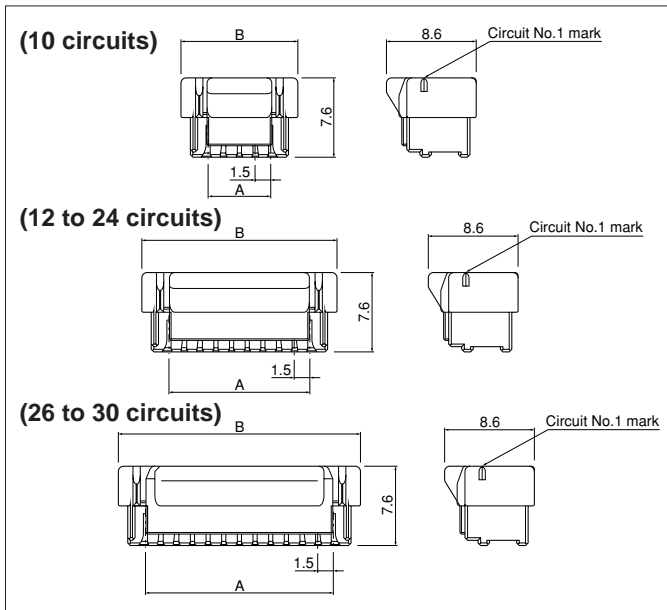

Circuits	Model No.	Dimensions (mm)		Q'ty / bag
		A	B	
10	ZPDR-10V-S	6.0	11.2	1,000
12	ZPDR-12V-S	7.5	12.7	1,000
14	ZPDR-14V-S	9.0	14.2	1,000
16	ZPDR-16V-S	10.5	15.7	1,000
18	ZPDR-18V-S	12.0	17.2	1,000
20	ZPDR-20V-S	13.5	18.7	1,000
22	ZPDR-22V-S	15.0	20.2	1,000
24	ZPDR-24V-S	16.5	21.7	1,000
26	ZPDR-26V-S	18.0	23.2	1,000
28	ZPDR-28V-S	19.5	24.7	500
30	ZPDR-30V-S	21.0	26.2	500

### Material

PBT, UL94V-0, natural

### RoHS compliance

<For reference> As the color identification, the following alphabet shall be put in the underlined part. For availability, delivery and minimum order quantity, contact JST.

ex. **ZPDR-10V-S**  
 S...natural Z...ivory MG...moss green TR...tomato red  
 DPK...dark pink E...blue

## Shrouded header

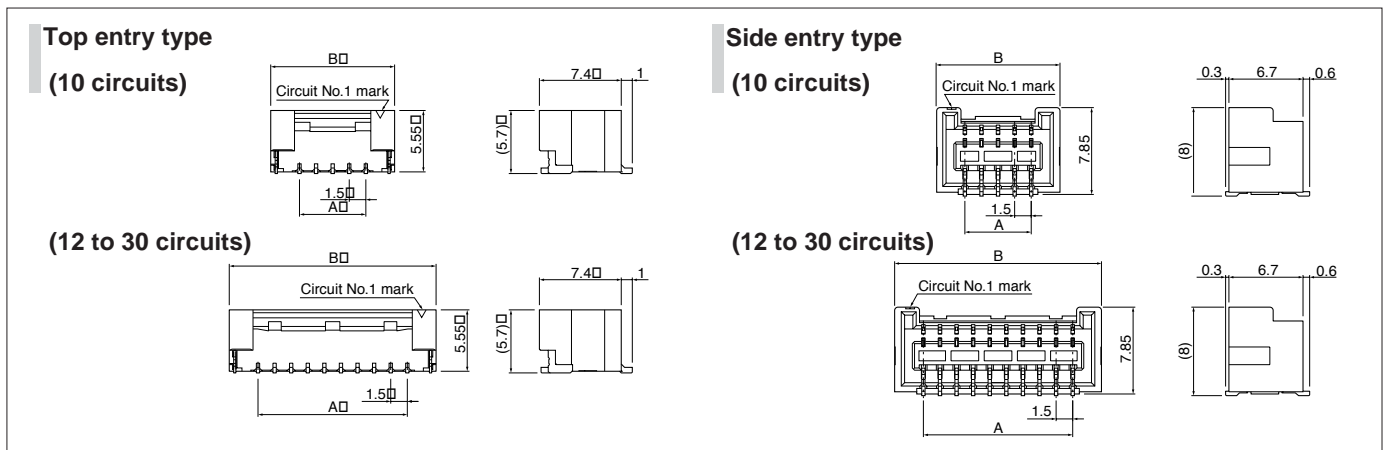

### Top entry type

Circuits	Model No.	Dimensions (mm)			Q'ty / reel
		A	B	C	
10	BM10B-ZPDSS-TF	6.0	11.2	9.2	1,000
12	BM12B-ZPDSS-TF	7.5	12.7	10.7	1,000
14	BM14B-ZPDSS-TF	9.0	14.2	12.2	1,000
16	BM16B-ZPDSS-TF	10.5	15.7	13.7	1,000
18	BM18B-ZPDSS-TF	12.0	17.2	15.2	1,000
20	BM20B-ZPDSS-TF	13.5	18.7	16.7	1,000
22	BM22B-ZPDSS-TF	15.0	20.2	18.2	1,000
24	BM24B-ZPDSS-TF	16.5	21.7	19.7	1,000
26	BM26B-ZPDSS-TF	18.0	23.2	21.2	1,000
28	BM28B-ZPDSS-TF	19.5	24.7	22.7	1,000
30	BM30B-ZPDSS-TF	21.0	26.2	24.2	1,000

### Material and Finish

Contact: Copper alloy, copper-undercoated, tin-plated (reflow treatment)  
 Wafer: Polyamide, UL94V-0, natural  
 Reinforcing tab: Copper alloy, copper-undercoated, tin-plated (reflow treatment)

**RoHS compliance** This product displays (LF)(SN) on a label. This products listed above are supplied on embossed-tape.

<For reference> As the color identification, the following alphabet shall be put in the underlined part. For availability, delivery and minimum order quantity, contact JST.

ex. **BM10B-ZPDSS-TF** **SM10B-ZPDSS-TF**  
 S...natural Z...ivory MG...moss green TR...tomato red DPK...dark pink E...blue

### Side entry type

Circuits	Model No.	Dimensions (mm)		Q'ty / reel
		A	B	
10	SM10B-ZPDSS-TF	6.0	11.2	700
12	SM12B-ZPDSS-TF	7.5	12.7	700
14	SM14B-ZPDSS-TF	9.0	14.2	700
16	SM16B-ZPDSS-TF	10.5	15.7	700
18	SM18B-ZPDSS-TF	12.0	17.2	700
20	SM20B-ZPDSS-TF	13.5	18.7	700
22	SM22B-ZPDSS-TF	15.0	20.2	700
24	SM24B-ZPDSS-TF	16.5	21.7	700
26	SM26B-ZPDSS-TF	18.0	23.2	700
28	SM28B-ZPDSS-TF	19.5	24.7	700
30	SM30B-ZPDSS-TF	21.0	26.2	700



### Material and Finish

Contact: Copper alloy, copper-undercoated, tin-plated (reflow treatment)  
 Wafer: Polyamide, UL94V-0, natural

**RoHS compliance** This product displays (LF)(SN) on a label. This products listed above are supplied on embossed-tape.

## Looking for pricing, stock, or lifecycle information?

Click below to explore more details on WIN SOURCE:

-  [View ZPDR-12V-S on WIN SOURCE](#)
-  [JST Sales America Inc. Information](#)

## Optimize Your Supply Chain with WIN SOURCE Solutions

-  Global Sourcing Solution
-  Obsolete Management
-  Cost Control Management
-  Shortage Management
-  Alternative Solution
-  Excess Inventory Management