



# PRECISION 2.5 VOLT MICROPOWER VOLTAGE REFERENCE

**ZR285-2.5**

ISSUE 5 – FEBRUARY 1998

## DEVICE DESCRIPTION

The ZR285 uses a bandgap circuit design to achieve a precision micropower voltage reference of 2.5 volts. The device is available in small outline surface mount packages, ideal for applications where space saving is important, as well as packages for through hole requirements.

The ZR285 design provides a stable voltage without an external capacitor and is stable with capacitive loads. The ZR285 is recommended for operation between 20 $\mu$ A and 20mA and so is ideally suited to low power and battery powered applications.

Excellent performance is maintained to an absolute maximum of 30mA, however the rugged design and 20 volt processing allows the reference to withstand transient effects and currents up to 200mA. Superior switching capability allows the device to reach stable operating conditions in only a few microseconds.

## FEATURES

- Small outline SOT23 and SO8 packages
- TO92 style packages
- No stabilising capacitor required
- Low knee current, 15 $\mu$ A typical
- Typical  $T_c$  30ppm/ $^{\circ}$ C
- Typical slope resistance 0.4 $\Omega$
- $\pm$  3%, 2% and 1% tolerance
- Industrial temperature range
- Operating current 20 $\mu$ A to 20mA

## APPLICATIONS

- Battery powered and portable equipment.
- Metering and measurement systems.
- Instrumentation.
- Test equipment.
- Data acquisition systems.
- Precision power supplies.

## SCHEMATIC DIAGRAM

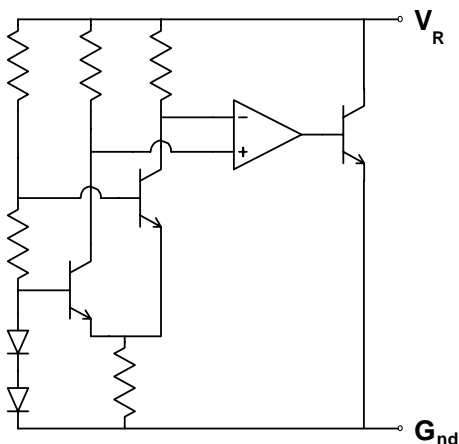

# ZR285-2.5

## ABSOLUTE MAXIMUM RATING

Reverse Current	30mA
Forward Current	25mA
Operating Temperature	-40 to 85°C
Storage Temperature	-55 to 125°C

## Power Dissipation (T<sub>amb</sub>=25°C)

SO8	625mW
SOT23	330mW
E-Line,2 Pin(TO92)	500mW
E-Line,3 Pin(TO92)	500mW

## ELECTRICAL CHARACTERISTICS

### TEST CONDITIONS (Unless otherwise stated) T<sub>amb</sub>=25°C

SYMBOL	PARAMETER	CONDITIONS	LIMITS			TOL. %	UNITS
			MIN	TYP	MAX		
V <sub>R</sub>	Reverse Breakdown Voltage	I <sub>R</sub> =150μA	2.475	2.5	2.525	1	V
			2.45	2.5	2.55	2	
			2.425	2.5	2.575	3	
I <sub>MIN</sub>	Minimum Operating Current		13	20		μA	
I <sub>R</sub>	Recommended Operating Current		0.02	20		mA	
T <sub>C</sub> †	Average Reverse Breakdown Voltage Temp. Co.	I <sub>R</sub> = 1mA to 20mA	30	90			ppm/°C
R <sub>S</sub> §	Slope Resistance		0.4	1			Ω
Z <sub>R</sub>	Reverse Dynamic Impedance	I <sub>R</sub> = 1mA f = 100Hz I <sub>AC</sub> =0.1 I <sub>R</sub>	0.3	0.8			Ω
E <sub>N</sub>	Wideband Noise Voltage	I <sub>R</sub> = 150μA f = 10Hz to 10kHz		60			μV (rms)

$$\dagger T_C = \frac{(V_{R(max)} - V_{R(min)}) \times 1000000}{V_R \times (T_{(max)} - T_{(min)})}$$

Note: V<sub>R(max)</sub> - V<sub>R(min)</sub> is the maximum deviation in reference voltage measured over the full operating temperature range.

$$\S R_S = \frac{V_R \text{ Change}(I_R(\min) \text{ to } I_R(\max))}{I_R(\max) - I_R(\min)}$$

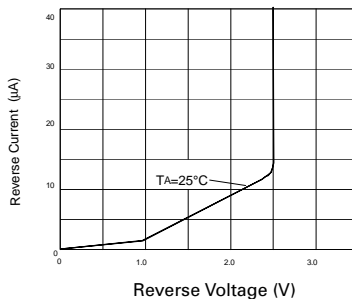

Reverse Characteristics

# ZR285-2.5

## TYPICAL CHARACTERISTICS

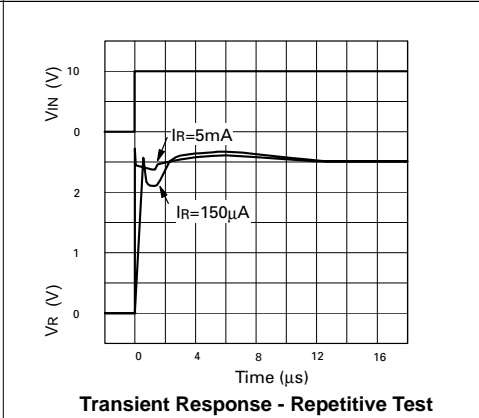
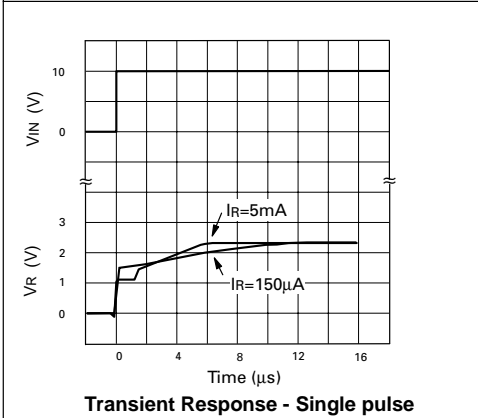
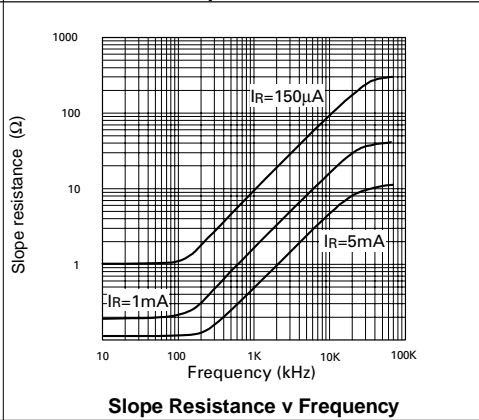
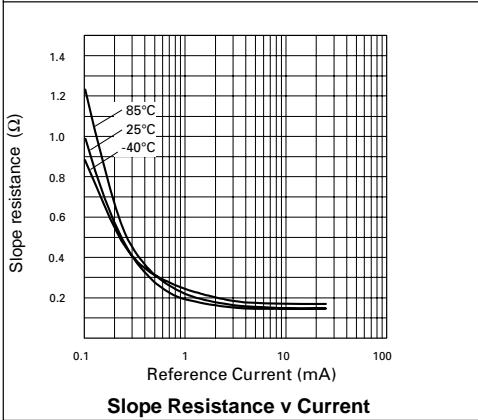
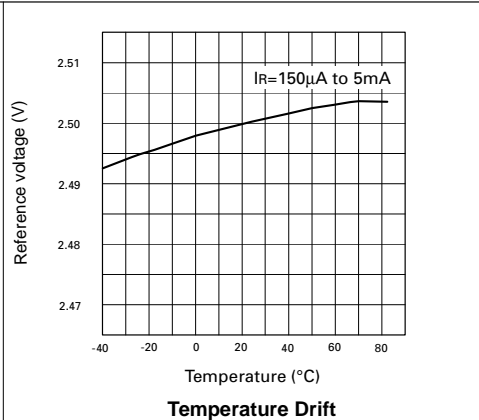
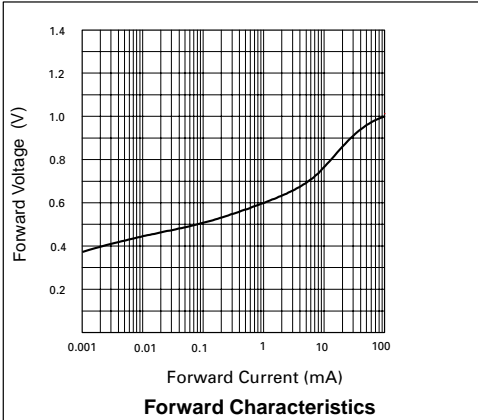

# ZR285-2.5

## CONNECTION DIAGRAMS

### E-Line, 2 pin Package Suffix - Y

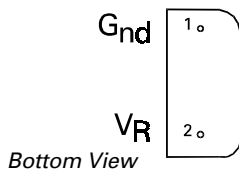

### E-Line, 3 pin, Rev Package Suffix - R

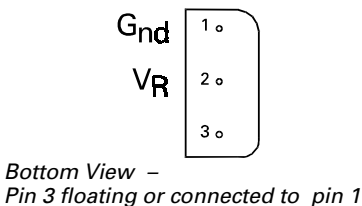

### SOT23 Package Suffix - F

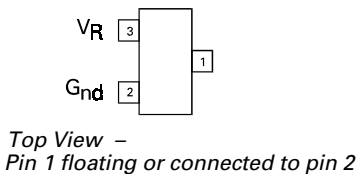

### SO8 Package Suffix - N8

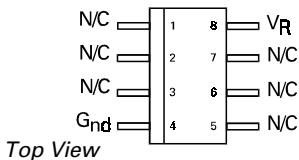

## ORDERING INFORMATION

Part No	Tol%	Package	Partmark
ZR285F03	3	SOT23	28A
ZR285F02	2	SOT23	28B
ZR285F01	1	SOT23	28C
ZR285N803	3	SO8	ZR285803
ZR285N802	2	SO8	ZR285802
ZR285N801	1	SO8	ZR285801
ZR285R03	3	E-Line *	ZR28503
ZR285R02	2	E-Line *	ZR28502

Part No	Tol%	Package	Partmark
ZR285R01	1	E-Line *	ZR28501
ZR285Y03	3	E-Line †	ZR28503
ZR285Y02	2	E-Line †	ZR28502
ZR285Y01	1	E-Line †	ZR28501

\* E-Line 3 pin Reversed







† E-Line 2 pin

# Looking for pricing, stock, or lifecycle information?

Click below to explore more details on WIN SOURCE:

-  View [ZR285N802TA](#) on WIN SOURCE
-  [Diodes Incorporated](#) Information

## Optimize Your Supply Chain with WIN SOURCE Solutions

-  Global Sourcing Solution
-  Obsolete Management
-  Cost Control Management
-  Shortage Management
-  Alternative Solution
-  Excess Inventory Management