



**THE DATASHEET OF
ZR40401F41TA**



PRECISION 4.1 VOLT MICROPOWER VOLTAGE REFERENCE

ZR4040-4.1

ISSUE 4- JANUARY 2003

DEVICE DESCRIPTION

The ZR4040-4.1 uses a bandgap circuit design to achieve a precision micropower voltage reference of 4.1 volts. The device is available in a small outline surface mount package, ideal for applications where space saving is important, as well as packages for through hole requirements.

The ZR4040-4.1 design provides a stable voltage without an external capacitor and is stable with capacitive loads. The ZR4040-4.1 is recommended for operation between 60 μ A and 15mA and so is ideally suited to low power and battery powered applications.

Excellent performance is maintained to an absolute maximum of 25mA, however the rugged design and 20 volt processing allows the reference to withstand transient effects and currents up to 200mA. Superior switching capability allows the device to reach stable operating conditions in only a few microseconds.

FEATURES

- Small outline SOT23 package
- TO92 style package
- No stabilising capacitor required
- Typical T_c 20ppm/ $^{\circ}$ C
- Typical slope resistance 0.55 Ω
- 2% and 1% tolerance
- Industrial temperature range
- Operating current 60 μ A to 15mA

APPLICATIONS

- Battery powered and portable equipment.
- Metering and measurement systems.
- Instrumentation.
- Test equipment.
- Data acquisition systems.
- Precision power supplies.
- Crystal oscillators.

SCHEMATIC DIAGRAM

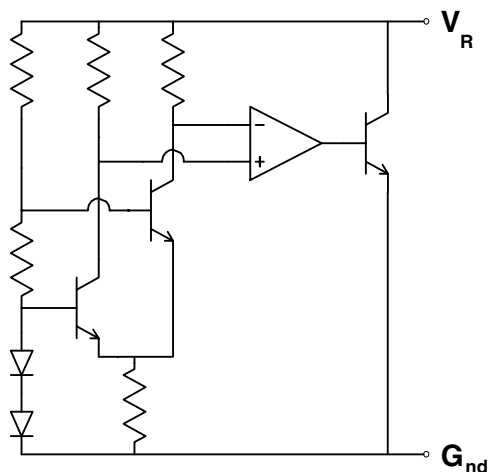

ZR4040-4.1

ABSOLUTE MAXIMUM RATING

Reverse Current	25mA
Forward Current	25mA
Operating Temperature	-40 to 85°C
Storage Temperature	-55 to 125°C

Power Dissipation (T_{amb}=25°C)

SOT23	330mW
E-Line, 3 pin (TO92)	500mW

ELECTRICAL CHARACTERISTICS

TEST CONDITIONS (Unless otherwise stated) T_{amb}= 25°C

SYMBOL	PARAMETER	CONDITION	LIMITS			TOL	UNITS
			MIN	TYP	MAX		
V _R	Reverse Breakdown Voltage	I _R =150μA	4.05 4.01	4.096 4.096	4.14 4.18	1 2	V
I _{MIN}	Minimum Operating Current			25	60		μA
I _R	Recommended Operating Current		0.06		15		mA
T _C †	Average Reverse Breakdown Voltage Temp. Co.	I _{R(min)} to I _{R(max)}		20	100		ppm/°C
R _S §	Slope Resistance			0.55	2		Ω
Z _R	Reverse Dynamic Impedance	I _R = 1mA f = 100Hz I _{AC} = 0.1 I _R		0.5	1.2		Ω
E _N	Wideband Noise Voltage	I _R = 1mA f = 10Hz to 10kHz		90			μV(rms)

$$\dagger T_C = \frac{(V_{R(max)} - V_{R(min)}) \times 1000000}{V_R \times (T_{(max)} - T_{(min)})}$$

Note: V_{R(max)} - V_{R(min)} is the maximum deviation in reference voltage measured over the full operating temperature range.

$$\S R_S = \frac{V_R \text{ Change } (I_R \text{ (min) to } I_R \text{ (max)})}{I_R \text{ (max)} - I_R \text{ (min)}}$$

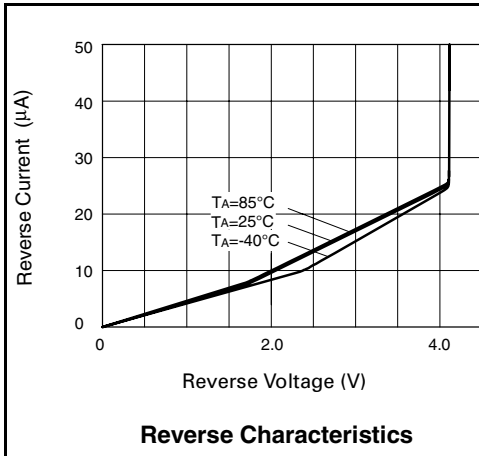

ZR4040-4.1

TYPICAL CHARACTERISTICS

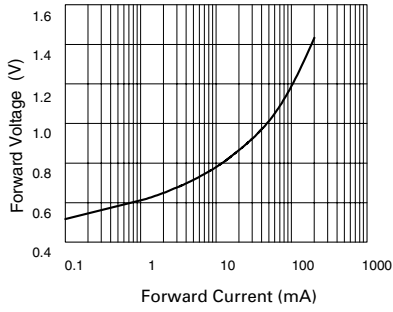

Forward Characteristics

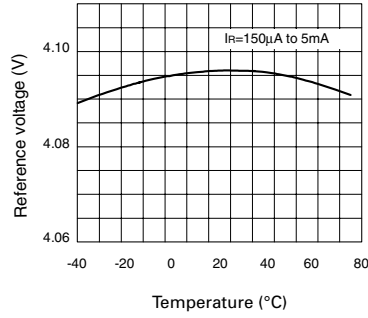

Temperature Drift

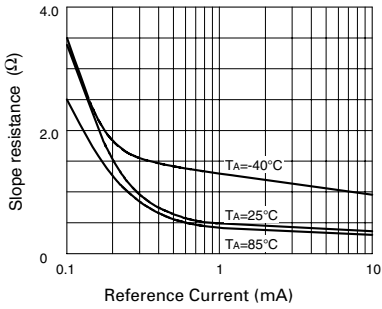

Slope Resistance v Current

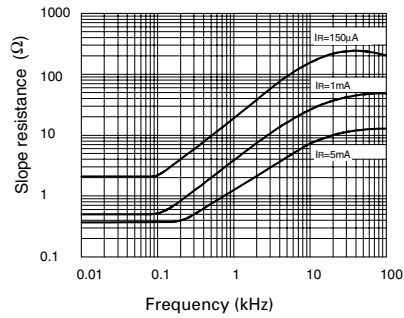

Slope Resistance v Frequency

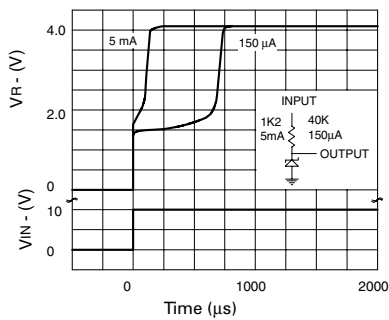

**Transient Response
(Single Pulse)**

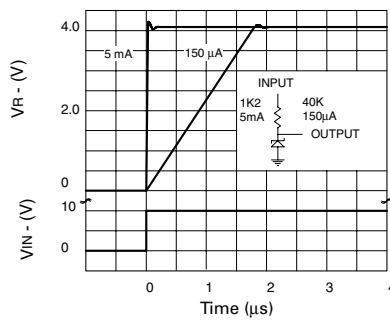

**Transient Response
(Repetitive Pulse)**

ZR4040-4.1

CONNECTION DIAGRAMS

E-Line, 3 pin, Rev Package Suffix - R

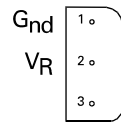

Bottom View -
Pin 3 floating or connected to pin 1

SOT23 Package Suffix - F

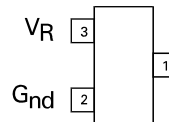

Top View -
Pin 1 floating or connected to pin 2



ORDERING INFORMATION

Part Number	Tol%	Package	Partmark
ZR40402F41	2	SOT23	40E
ZR40401F41	1	SOT23	40F
ZR40402R41	2	E-Line *	ZR4040241
ZR40401R41	1	E-Line *	ZR4040141

* E-Line, 3 pin Reversed

Looking for pricing, stock, or lifecycle information?

Click below to explore more details on WIN SOURCE:

-  [View ZR40401F41TA on WIN SOURCE](#)
-  [Diodes Incorporated Information](#)

Optimize Your Supply Chain with WIN SOURCE Solutions

-  Global Sourcing Solution
-  Obsolete Management
-  Cost Control Management
-  Shortage Management
-  Alternative Solution
-  Excess Inventory Management