



**THE DATASHEET OF
ZRC330N801TA**



PRECISION 3.3 VOLT LOW CURRENT VOLTAGE REFERENCE

ISSUE 2 - FEBRUARY 1997

DEVICE DESCRIPTION

The ZRC330 uses a bandgap circuit design to achieve a precision micropower voltage reference of 3.3 volts. The device is available in small outline surface mount packages for applications where space saving is important.

The ZRC330 design provides a stable voltage without an external capacitor and is stable over a wide range of operating conditions and capacitive loads. The ZRC330 is recommended for operation between 20µA and 5mA and is ideally suited to low power and battery powered applications.

Excellent performance is maintained over a wide range of operating conditions. The suggested absolute maximum of 200µA, however the rugged design and 200µA current processing allows the reference to withstand transient effects and currents up to 200µA. Superior switching capability allows the device to reach stable operating conditions in a few microseconds.

FEATURES

- Small outline SOT23, SO8 and TO92 style packages

SCHEMATIC DIAGRAM

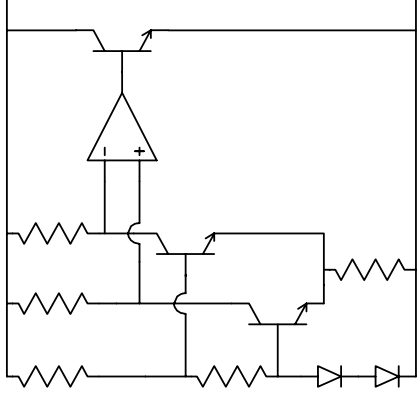

ZRC330

ABSOLUTE MAXIMUM RATING

Reverse Current	25mA
Forward Current	25mA
Operating Temperature	-40 to 85°C
Storage Temperature	-55 to 125°C

Power Dissipation (T_{amb}=25°C)

SOT23	330mW
E-Line, 3 pin (TO92)	500mW
E-Line, 2 pin (TO92)	500mW
SO8	625mW

ELECTRICAL CHARACTERISTICS

TEST CONDITIONS (Unless otherwise stated) T_{amb}=25°C

SYMBOL	PARAMETER	CONDITIONS	LIMITS			TOL.%	UNITS
			MIN	TYP	MAX		
V _R	Reverse Breakdown Voltage	I _R =150μA	3.27	3.3	3.33	1	V
			3.234	3.3	3.366	2	
			3.2	3.3	3.4	3	
I _{MIN}	Minimum Operating Current		15	20			μA
I _R	Recommended Operating Current		0.02	5			mA
T _C †	Average Reverse Breakdown Voltage Temp. Co.	I _R (min) to I _R (max)	15	50			ppm/°C
R _S §	Slope Resistance		0.6	2			Ω
Z _R	Reverse Dynamic Impedance	I _R = 1mA f = 100Hz I _{AC} = 0.1 I _R	0.5	1.2			Ω
E _N	Wideband Noise Voltage	I _R = 150μA f = 10Hz to 10kHz	43				μV(rms)

$$\dagger T_C = \frac{V_R \text{ Change} \times 1000000}{V_R \times \text{Temperature Change}}$$

$$\S R_S = \frac{V_R \text{ Change}(I_R(\text{min}) \text{ to } I_R(\text{max}))}{I_R(\text{max}) - I_R(\text{min})}$$

TYPICAL

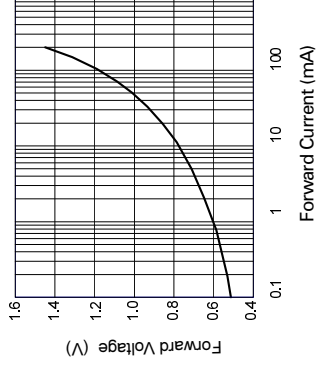

Forward Characteristics

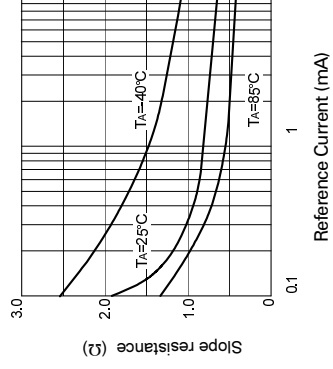

Slope Resistance v Current

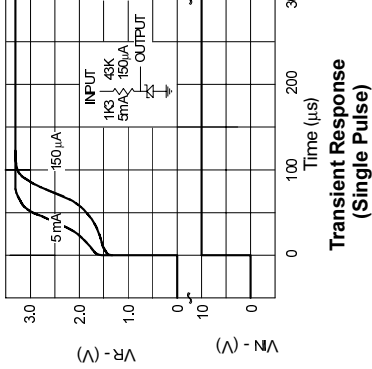

Transient Response (Single Pulse)

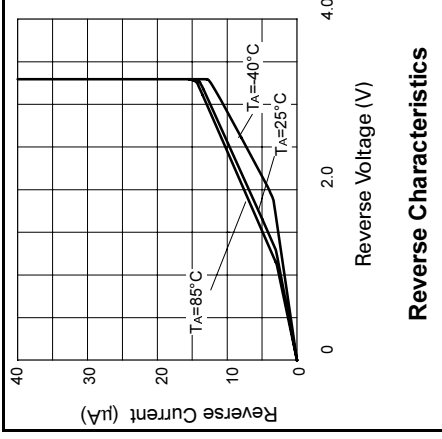

Reverse Characteristics

ZRC330

ABSOLUTE MAXIMUM RATING

Reverse Current 25mA
 Forward Current 25mA
 Operating Temperature -40 to 85°C
 Storage Temperature -55 to 125°C

Power Dissipation (T_{amb}=25°C)

SOT23 330mW
 E-Line, 3 pin (TO92) 500mW
 E-Line, 2 pin (TO92) 500mW
 SO8 625mW

ELECTRICAL CHARACTERISTICS

TEST CONDITIONS (Unless otherwise stated) T_{amb}=25°C

SYMBOL	PARAMETER	CONDITIONS	LIMITS			TOL. %	UNITS
			MIN	TYP	MAX		
V _R	Reverse Breakdown Voltage	I _R =150µA	3.27	3.3	3.33	1	V
			3.234	3.3	3.366	2	
			3.2	3.3	3.4	3	
I _{MIN}	Minimum Operating Current		15	20			µA
I _R	Recommended Operating Current		0.02	5			mA
T _C †	Average Reverse Breakdown Voltage Temp. Co.	I _R (min) to I _R (max)	15	50			ppm/°C
R _S §	Slope Resistance		0.6	2			Ω
Z _R	Reverse Dynamic Impedance	I _R = 1mA f = 100Hz I _{AC} = 0.1 I _R	0.5	1.2			Ω
E _N	Wideband Noise Voltage	I _R = 150µA f = 10Hz to 10KHZ	43				µV(rms)

$$\dagger T_C = \frac{V_R \text{ Change} \times 1000000}{V_R \times \text{Temperature Change}}$$

$$\S R_S = \frac{V_R \text{ Change}(I_R(\text{min}) \text{ to } I_R(\text{max}))}{I_R(\text{max}) - I_R(\text{min})}$$

TYPICAL

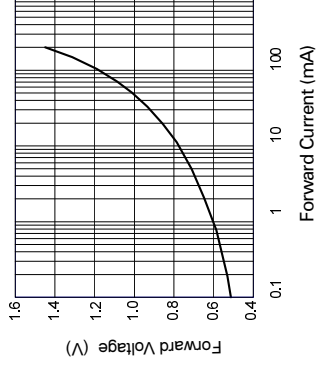

Forward Characteristics

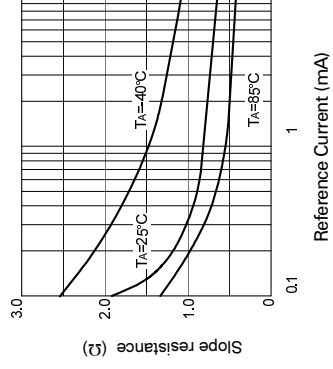

Slope Resistance v Current

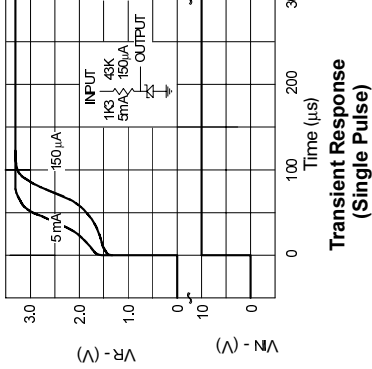

Transient Response (Single Pulse)

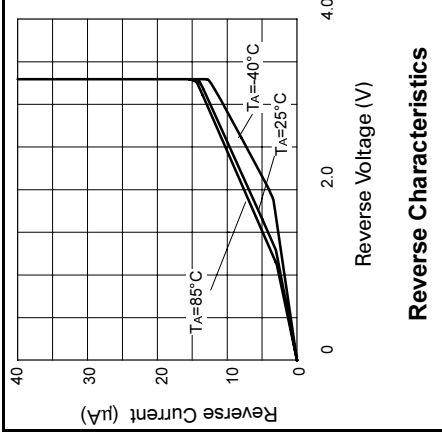

Reverse Characteristics

ZRC330

CONNECTION DIAGRAMS

E-Line, 2 pin Package Suffix – Y

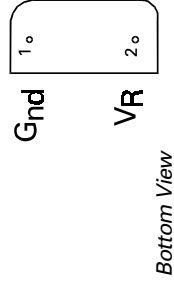

E-Line, 3 pin, Rev Package Suffix – R

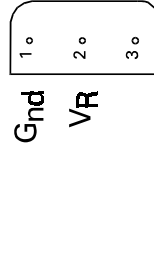

E-Line, 3 pin Package Suffix – A

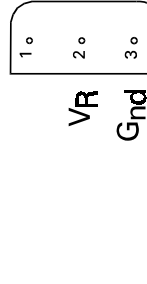

SO8 Package Suffix – N8

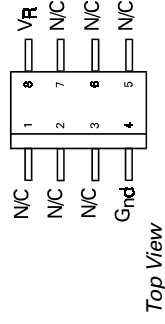

SOT23 Package Suffix – F

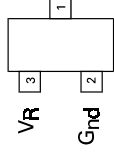

Part No	Tol%	Package	Partn
ZRC330A03	3	E-Line •	ZRC3
ZRC330A02	2	E-Line •	ZRC3
ZRC330A01	1	E-Line •	ZRC3
ZRC330F03	3	SOT23	33A
ZRC330F02	2	SOT23	33B
ZRC330F01	1	SOT23	33C
ZRC330N803	3	SO8	ZRC3
ZRC330N802	2	SO8	ZRC3
ZRC330N801	1	SO8	ZRC3

ZRC330

CONNECTION DIAGRAMS

E-Line, 2 pin Package Suffix – Y

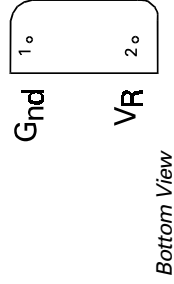

E-Line, 3 pin, Rev Package Suffix – R

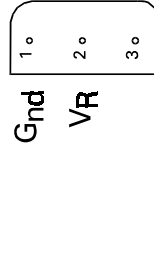

E-Line, 3 pin Package Suffix – A

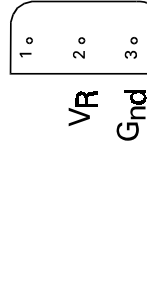

SO8 Package Suffix – N8

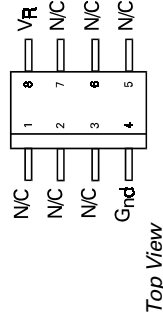

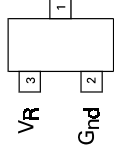

SOT23 Package Suffix – F



Part No	Tol%	Package	Part No
ZRC330A03	3	E-Line •	ZRC330
ZRC330A02	2	E-Line •	ZRC330
ZRC330A01	1	E-Line •	ZRC330
ZRC330F03	3	SOT23	33A
ZRC330F02	2	SOT23	33B
ZRC330F01	1	SOT23	33C
ZRC330N803	3	SO8	ZRC330
ZRC330N802	2	SO8	ZRC330
ZRC330N801	1	SO8	ZRC330

Looking for pricing, stock, or lifecycle information?

Click below to explore more details on WIN SOURCE:

-  [View ZRC330N801TA on WIN SOURCE](#)
-  [Diodes Incorporated Information](#)

Optimize Your Supply Chain with WIN SOURCE Solutions

-  Global Sourcing Solution
-  Obsolete Management
-  Cost Control Management
-  Shortage Management
-  Alternative Solution
-  Excess Inventory Management