



THE DATASHEET OF ZSR500C



ZSR SERIES

3.0 to 12 volt fixed positive local voltage regulator

Description

The ZSR Series three terminal fixed positive voltage regulators feature internal circuit current limit and thermal shutdown making the devices difficult to destroy. The devices are available in a high power surface mount package, ideal for applications where space saving is important. The devices are suited to local voltage regulation applications, where problems could be encountered with distributed single source regulation, as well as more general voltage regulation applications.

The ZSR Series show performance characteristics superior to other local voltage regulators. The initial output voltage is maintained to within 2.5% with a quiescent current of typically 350 μ A. Output voltage change, with input voltage and load current, is much lower than competitive devices. The ZSR devices are completely stable with no external components.

Features

- Output current up to 200mA
- Tight initial tolerance of 2.5%
- Low 600 μ A quiescent current
- -55 to 125°C temperature range
- No external components
- Internal thermal shutdown
- Internal short circuit current limit
- High power SOT223 package

SOT223 Package suffix - G

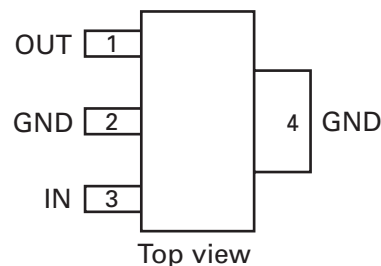

Top view –
Connect pin 4 to pin 2 or leave pin 4 electrically isolated

SOT223 ordering information

Order reference	Voltage	Part marking	Status	Reel size (inches)	Tape width (mm)	Quantity per reel
ZSR300GTA	3.0V	ZSR300	Active	7	12	1000
ZSR330GTA	3.3V	ZSR330	Active	7	12	1000
ZSR500GTA	5.0V	ZSR500	Active	7	12	1000
ZSR800GTA	8.0V	ZSR800	Active	7	12	1000
ZSR1000GTA	10.0V	ZSR100	Active	7	12	1000
ZSR1200GTA	12.0V	ZSR1200	Active	7	12	1000

ZSR SERIES

Absolute maximum rating

Input voltage	20V
Output current (I _O)	200mA
Operating temperature	-55 to 125°C
Storage temperature	-65 to 150°C

Power Dissipation (T_{amb}=25°C)

SOT223 2W

Maximum power dissipation for the SOT223 is calculated assuming that the device is mounted on a PCB measuring 2 inches square.

Recommended operating conditions

Parameter	Products	Min	Max	Units
V _{in} Input Voltage	ZSR300	5	20	V
	ZSR330	5.3	20	V
	ZSR500	7	20	V
	ZSR800	10	20	V
	ZSR1000	12	20	V
	ZSR1200	14	20	V

Notes:

- The maximum operating input voltage and output current of the device will be governed by the maximum power dissipation of the selected package. Maximum package power dissipation is specified at 25°C and must be linearly derated to zero at T_{amb}=125°C.
- The following data represents pulse test conditions with junction temperatures as indicated at the initiation of the test. Continuous operation of the devices with the stated conditions might exceed the power dissipation limits of the chosen package.
- The shut down feature of the device operates if its temperature exceeds its design limit as might occur during external faults, short circuits etc. If the regulator is supplied from an inductive source then a large voltage transient, on the regulator input, can result should the shut down circuit operate. It is advised that a capacitor (1µF or greater) should be applied across the regulator input to ensure that the maximum voltage rating of the device is not exceeded under shutdown conditions.

ZSR SERIES

Electrical characteristics

ZSR300 test conditions (Unless otherwise stated): $T_j=25^{\circ}\text{C}$, $I_O=100\text{mA}$, $V_{in}=7\text{V}$

Symbol	Parameter	Conditions	Min.	Typ.	Max.	Units
V_O	Output Voltage		2.92	3.0	3.08	V
		$I_O=1$ to $200\text{mA}^{(\tau)}$	2.88		3.12	V
		$V_{in}=5$ to 20V $I_O=1$ to $100\text{mA}^{(\tau)}$	2.88		3.12	V
ΔV_O	Line regulation	$V_{in}=5$ to 20V		10	40	mV
ΔV_O	Load regulation	$I_O=1$ to 200mA		5	25	mV
		$I_O=1$ to 100mA		2		mV
I_g	Quiescent current	(τ)		350	600	μA
ΔI_g	Quiescent current change	$I_O=1$ to 200mA			100	μA
		$V_{in}=1$ to 20V			100	μA
V_n	Output noise voltage	$f=10\text{Hz}$ to 10Hz		75		$\mu\text{V rms}$
$\Delta V_{in}/\Delta V_O$	Ripple rejection	$V_{in}=1$ to 20V $f=120\text{Hz}$	48	62		dB
V_{in}	Input voltage required to maintain regulation			4.7		V
$\Delta V_O/\Delta T$	Average temperature coefficient of V_O	$I_O=5.0\text{mA}^{(\tau)}$		0.1		$\text{mV}/^{\circ}\text{C}$

ZSR330 test conditions (Unless otherwise stated): $T_j=25^{\circ}\text{C}$, $I_O=100\text{mA}$, $V_{in}=7.3\text{V}$

Symbol	Parameter	Conditions	Min.	Typ.	Max.	Units
V_O	Output Voltage		3.218	3.3	3.382	V
		$I_O=1$ to $200\text{mA}^{(\tau)}$	3.168		3.432	V
		$V_{in}=5.3$ to 20V $I_O=1$ to $100\text{mA}^{(\tau)}$	3.168		3.432	V
ΔV_O	Line regulation	$V_{in}=5.3$ to 20V		7.5	30	mV
ΔV_O	Load regulation	$I_O=1$ to 200mA		5	25	mV
		$I_O=1$ to 100mA		2		mV
I_g	Quiescent current	(τ)		350	600	μA
ΔI_g	Quiescent current change	$I_O=1$ to 200mA			100	μA
		$V_{in}=5.3$ to 20V			100	μA
V_n	Output noise voltage	$f=10\text{Hz}$ to 10Hz		50		$\mu\text{V rms}$
$\Delta V_{in}/\Delta V_O$	Ripple rejection	$V_{in}=6.3$ to 18V $f=120\text{Hz}$	50	64		dB
V_{in}	Input voltage required to maintain regulation			5		V
$\Delta V_O/\Delta T$	Average temperature coefficient of V_O	$I_O=5.0\text{mA}^{(\tau)}$		0.1		$\text{mV}/^{\circ}\text{C}$

NOTES:

$(\tau)T_j=-55$ to 125°C

ZSR SERIES

ZSR500 test conditions (Unless otherwise stated): $T_j=25^{\circ}\text{C}$, $I_O=100\text{mA}$, $V_{in}=9\text{V}$

Symbol	Parameter	Conditions	Min.	Typ.	Max.	Units
V_O	Output Voltage		4.875	5	5.126	V
		$I_O=1$ to $200\text{mA}^{(\tau)}$	4.8		5.2	V
		$V_{in}=7$ to 20V $I_O=1$ to $100\text{mA}^{(\tau)}$	4.8		5.2	V
ΔV_O	Line regulation	$V_{in}=7$ to 20V		10	40	mV
ΔV_O	Load regulation	$I_O=1$ to 200mA		5	25	mV
		$I_O=1$ to 100mA		2		mV
I_g	Quiescent current	(τ)		350	600	μA
ΔI_g	Quiescent current change	$I_O=1$ to 200mA			100	μA
		$V_{in}=7$ to 20V			100	μA
V_n	Output noise voltage	$f=10\text{Hz}$ to 10Hz		75		$\mu\text{V rms}$
$\Delta V_{in}/\Delta V_O$	Ripple rejection	$V_{in}=8$ to 18V $f=120\text{Hz}$	48	62		dB
V_{in}	Input voltage required to maintain regulation		7	6.7		V
$\Delta V_O/\Delta T$	Average temperature coefficient of V_O	$I_O=5.0\text{mA}^{(\tau)}$		0.1		$\text{mV}/^{\circ}\text{C}$

ZSR800 test conditions (Unless otherwise stated): $T_j=25^{\circ}\text{C}$, $I_O=100\text{mA}$, $V_{in}=12\text{V}$

Symbol	Parameter	Conditions	Min.	Typ.	Max.	Units
V_O	Output Voltage		7.8	8	8.25	V
		$I_O=1$ to $200\text{mA}^{(\tau)}$	7.68		8.32	V
		$V_{in}=10$ to 20V $I_O=1$ to $100\text{mA}^{(\tau)}$	7.68		8.32	V
ΔV_O	Line regulation	$V_{in}=10$ to 20V		11	40	mV
ΔV_O	Load regulation	$I_O=1$ to 200mA		8	30	mV
		$I_O=1$ to 100mA		3		mV
I_g	Quiescent current	(τ)		350	600	μA
ΔI_g	Quiescent current change	$I_O=1$ to 200mA			100	μA
		$V_{in}=10$ to 20V			100	μA
V_n	Output noise voltage	$f=10\text{Hz}$ to 10Hz		115		$\mu\text{V rms}$
$\Delta V_{in}/\Delta V_O$	Ripple rejection	$V_{in}=11$ to 18V $f=120\text{Hz}$	44	60		dB
V_{in}	Input voltage required to maintain regulation			9.7		V
$\Delta V_O/\Delta T$	Average temperature coefficient of V_O	$I_O=5.0\text{mA}^{(\tau)}$		0.25		$\text{mV}/^{\circ}\text{C}$

NOTES:

$(\tau) T_j=-55$ to 125°C

ZSR SERIES

ZSR1000 test conditions (Unless otherwise stated): $T_j=25^\circ\text{C}$, $I_O=100\text{mA}$, $V_{in}=14\text{V}$

Symbol	Parameter	Conditions	Min.	Typ.	Max.	Units
V_O	Output Voltage		9.75	10	10.25	V
		$I_O=1$ to $200\text{mA}^{(\tau)}$	9.6		10.4	V
		$V_{in}=12$ to 20V $I_O=1$ to $100\text{mA}^{(\tau)}$	9.6		10.4	V
ΔV_O	Line regulation	$V_{in}=12$ to 20V		12	40	mV
ΔV_O	Load regulation	$I_O=1$ to 200mA		9	30	mV
		$I_O=1$ to 100mA		3		mV
I_g	Quiescent current	(τ)		350	600	μA
ΔI_g	Quiescent current change	$I_O=1$ to 200mA			100	μA
		$V_{in}=12$ to 20V			100	μA
V_n	Output noise voltage	$f=10\text{Hz}$ to 10Hz		150		$\mu\text{V rms}$
$\Delta V_{in}/\Delta V_O$	Ripple rejection	$V_{in}=13$ to 18V $f=120\text{Hz}$	43	57		dB
V_{in}	Input voltage required to maintain regulation			11.7		V
$\Delta V_O/\Delta T$	Average temperature coefficient of V_O	$I_O=5.0\text{mA}^{(\tau)}$		0.25		$\text{mV}/^\circ\text{C}$

ZSR1200 test conditions (Unless otherwise stated): $T_j=25^\circ\text{C}$, $I_O=100\text{mA}$, $V_{in}=16\text{V}$

Symbol	Parameter	Conditions	Min.	Typ.	Max.	Units
V_O	Output Voltage		11.7	12	12.3	V
		$I_O=1$ to $200\text{mA}^{(\tau)}$	11.52		12.48	V
		$V_{in}=14$ to 20V $I_O=1$ to $100\text{mA}^{(\tau)}$	11.52		12.48	V
ΔV_O	Line regulation	$V_{in}=14$ to 20V		12	40	mV
ΔV_O	Load regulation	$I_O=1$ to 200mA		9	30	mV
		$I_O=1$ to 100mA		3		mV
I_g	Quiescent current	(τ)		350	600	μA
ΔI_g	Quiescent current change	$I_O=1$ to 200mA			100	μA
		$V_{in}=14$ to 20V			100	μA
V_n	Output noise voltage	$f=10\text{Hz}$ to 10Hz		150		$\mu\text{V rms}$
$\Delta V_{in}/\Delta V_O$	Ripple rejection	$V_{in}=15$ to 18V $f=120\text{Hz}$	43	57		dB
V_{in}	Input voltage required to maintain regulation			13.7		V
$\Delta V_O/\Delta T$	Average temperature coefficient of V_O	$I_O=5.0\text{mA}^{(\tau)}$		0.25		$\text{mV}/^\circ\text{C}$

NOTES:

$(\tau) T_j=-55$ to 125°C

ZSR SERIES

Schematic diagram

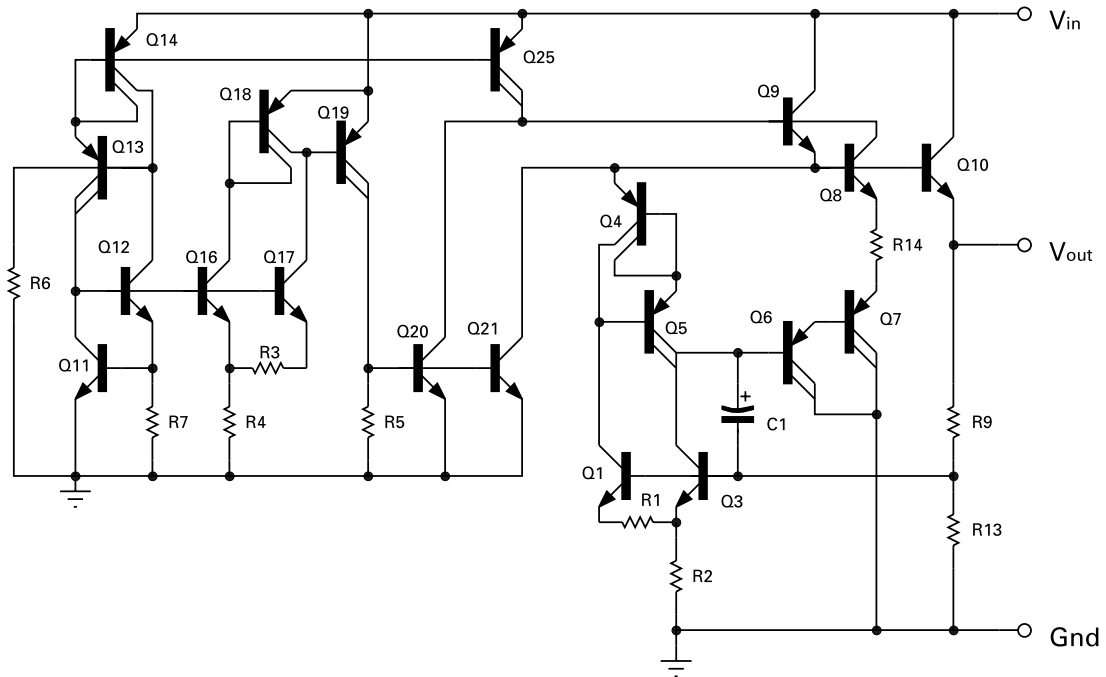

Applications

Fixed Output Regulator

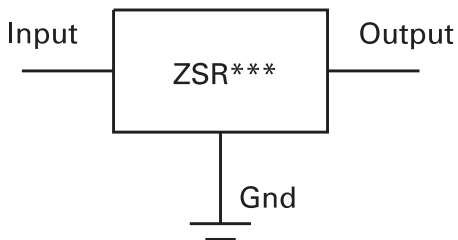

Adjustable Output Regulator

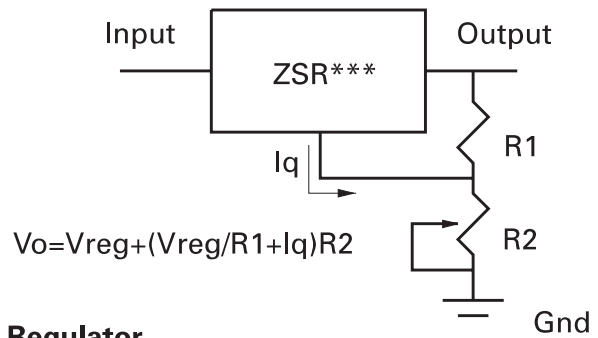

Current Regulator

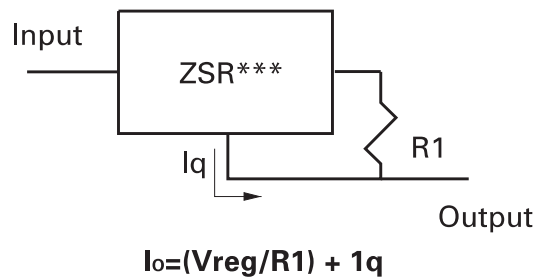

ZSR SERIES

Typical characteristics

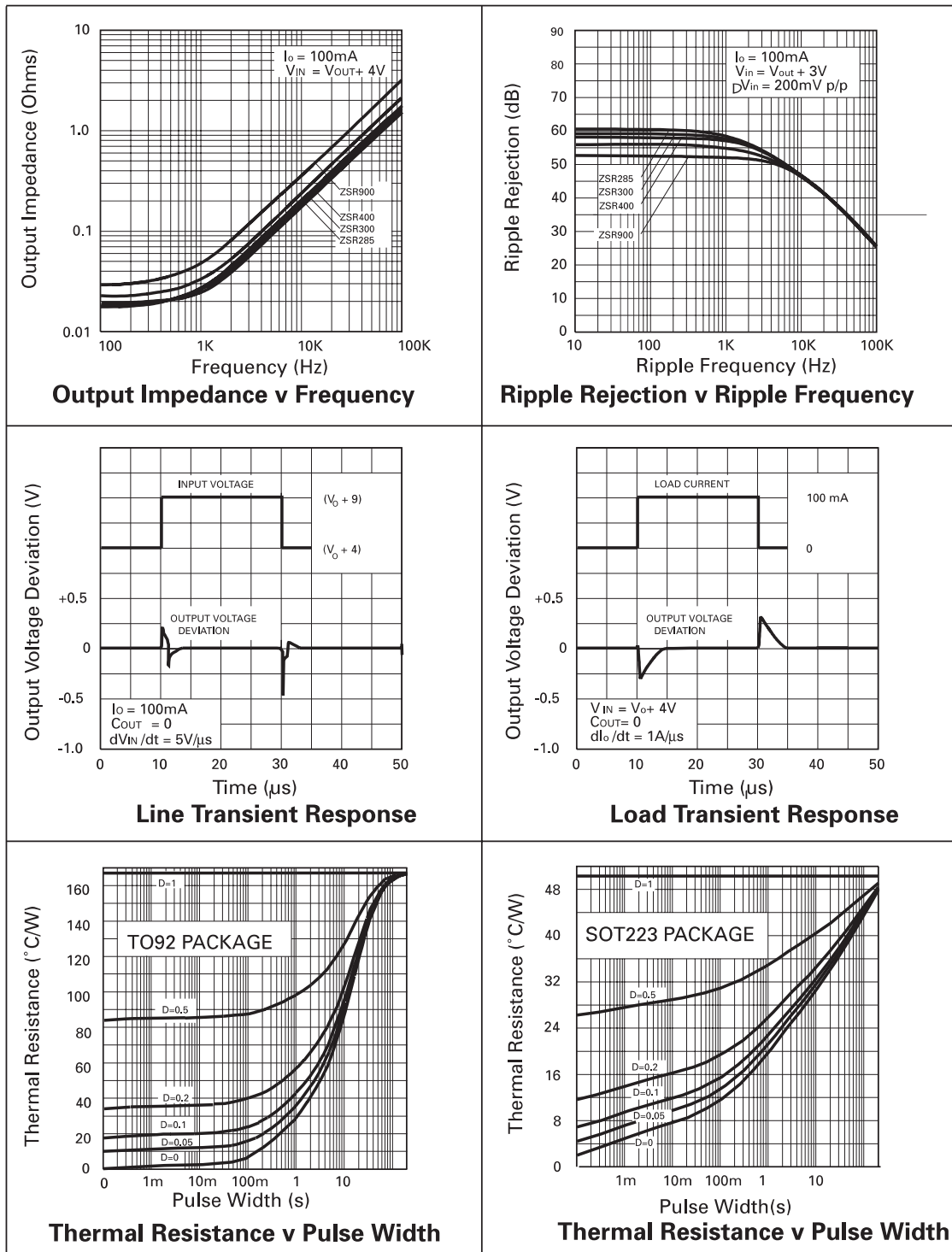

Typical characteristics

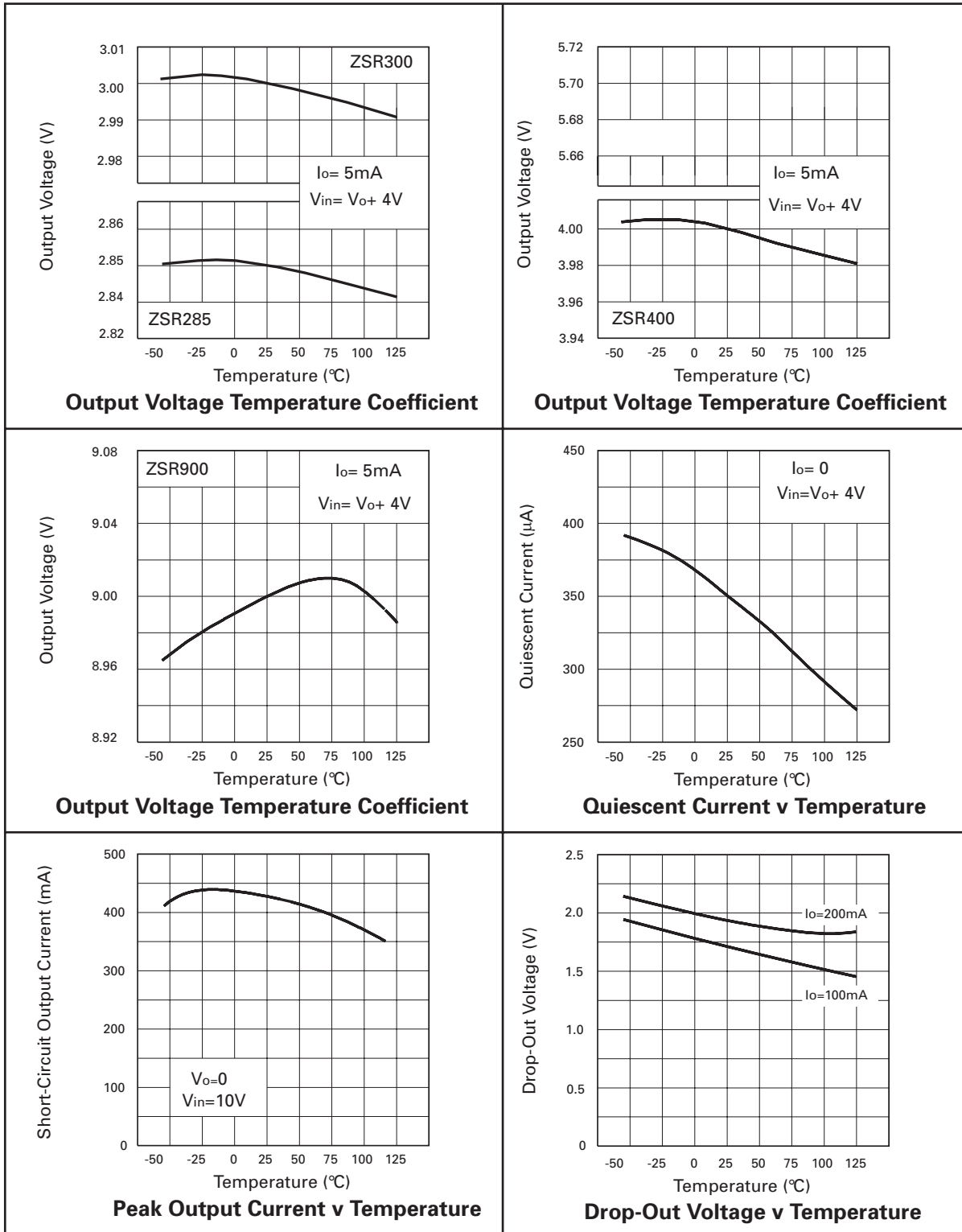

ZSR SERIES

Typical characteristics

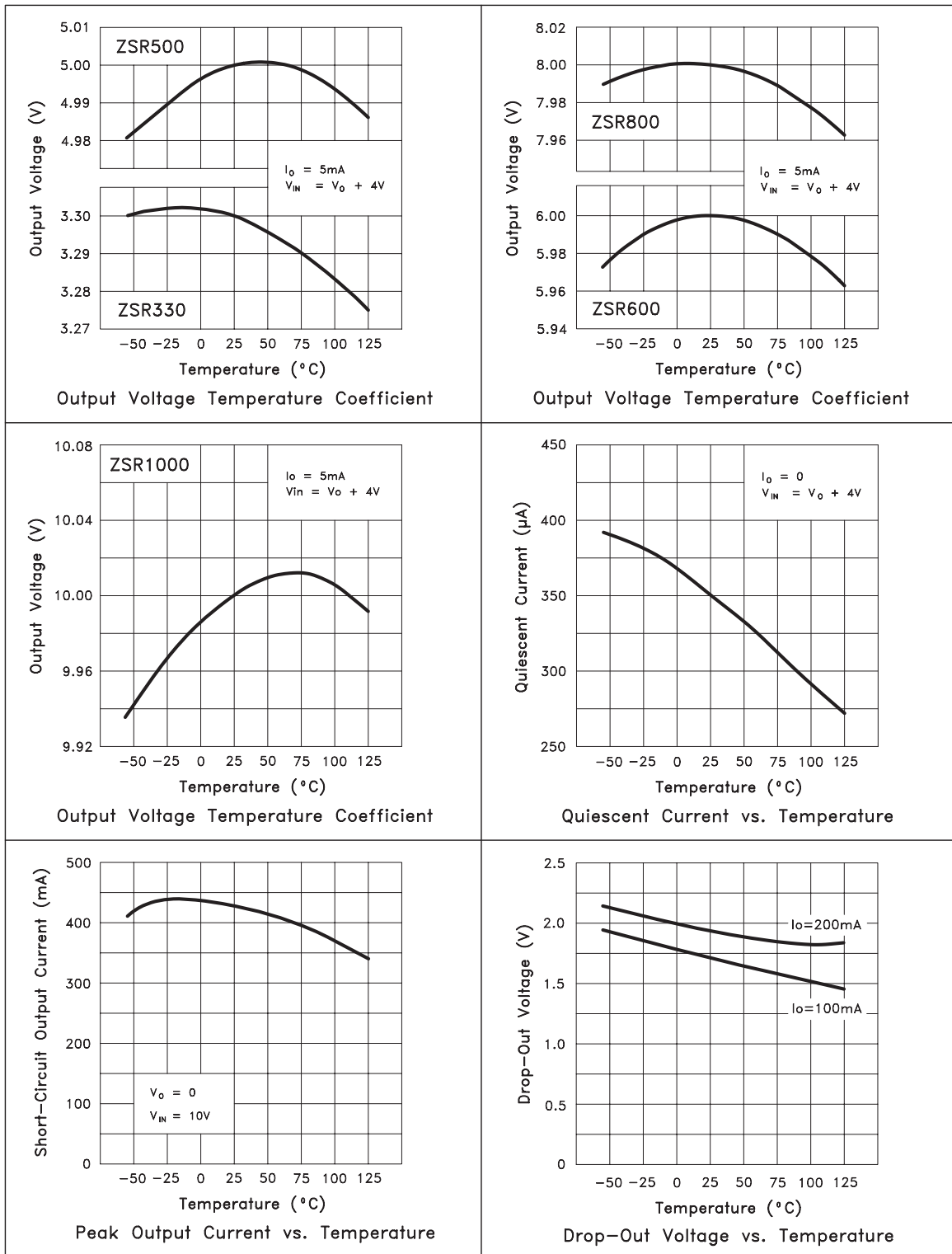

ZSR SERIES

Typical characteristics

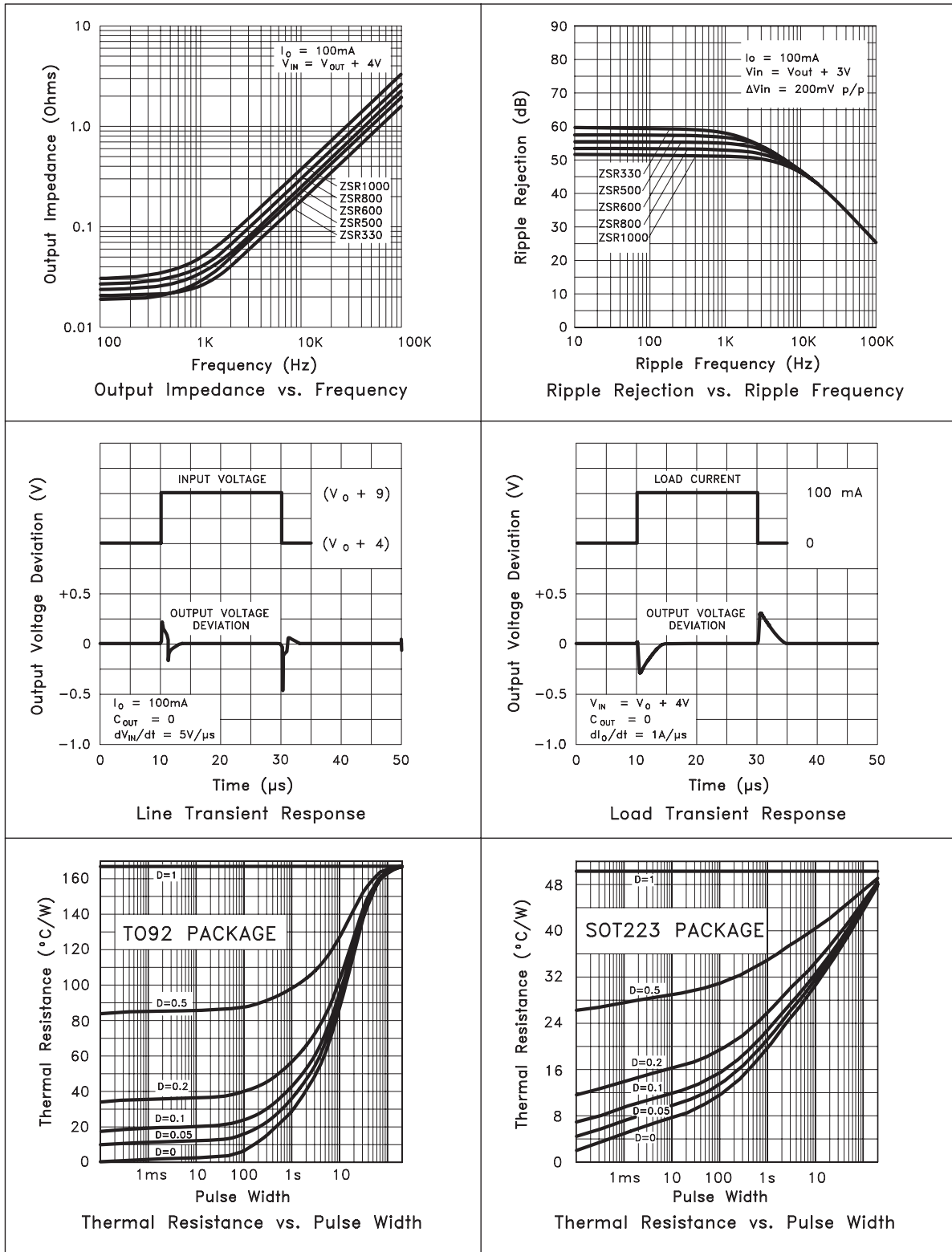

ZSR SERIES

Typical characteristics

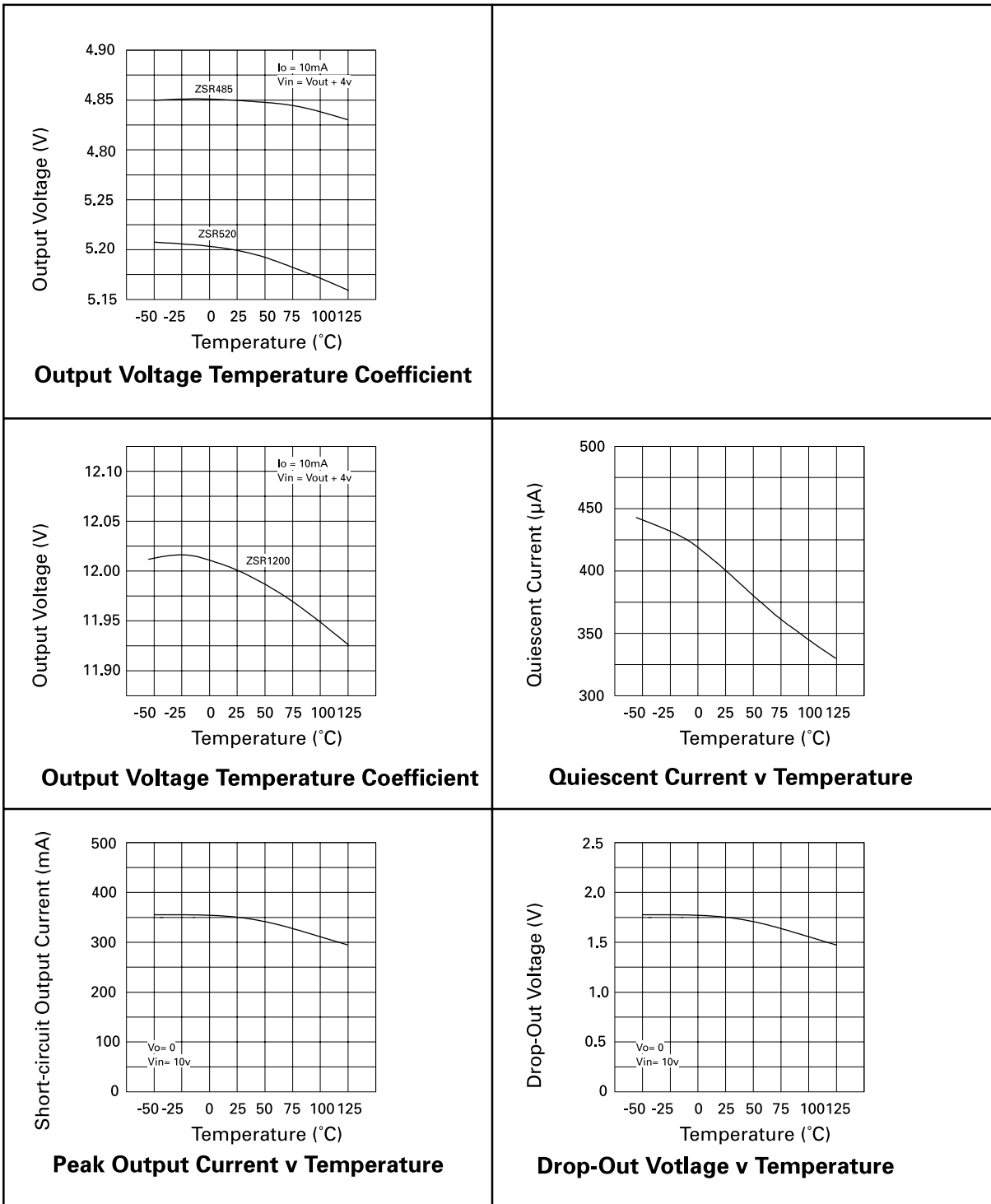

ZSR SERIES

Typical characteristics

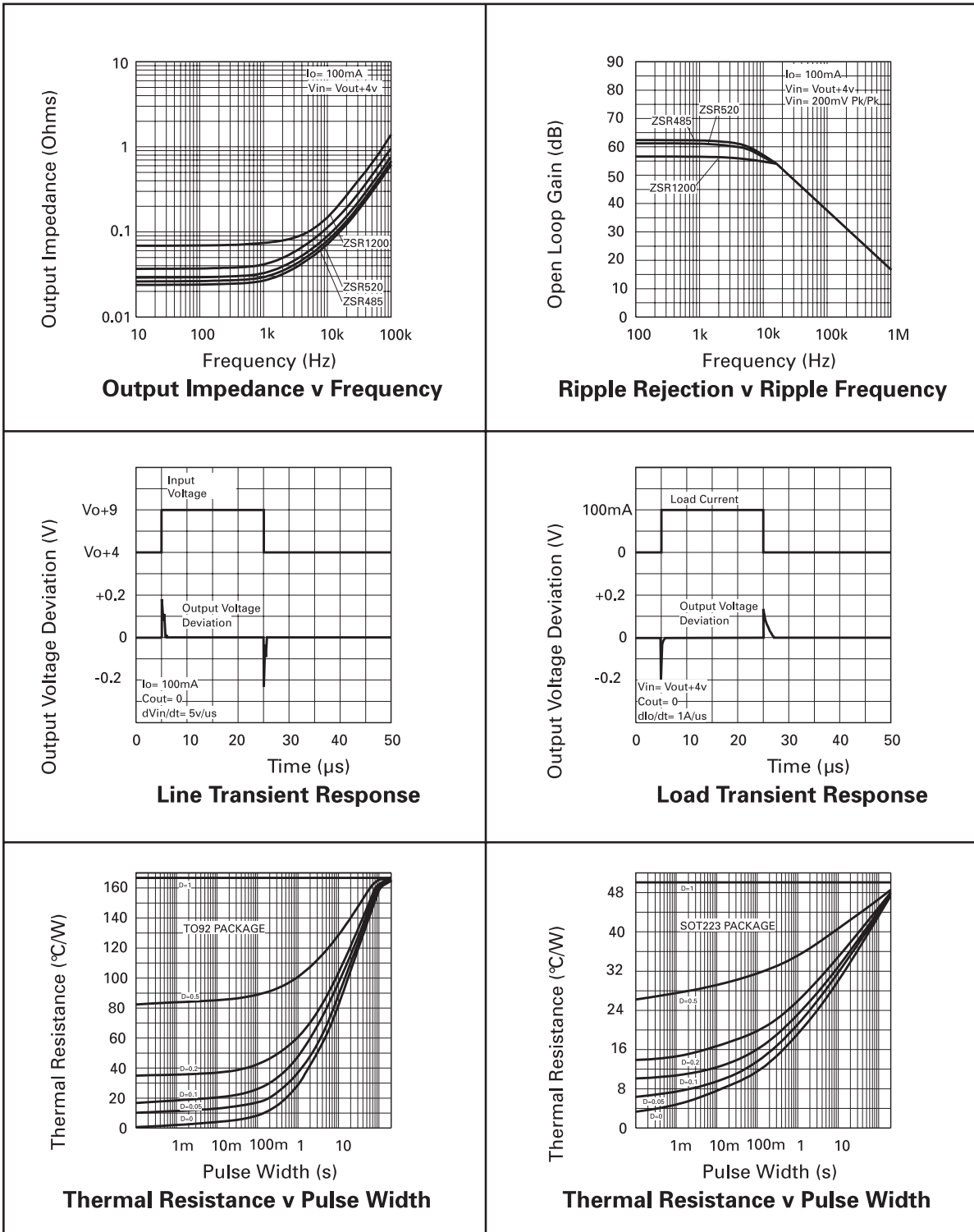

ZSR SERIES

Typical characteristics

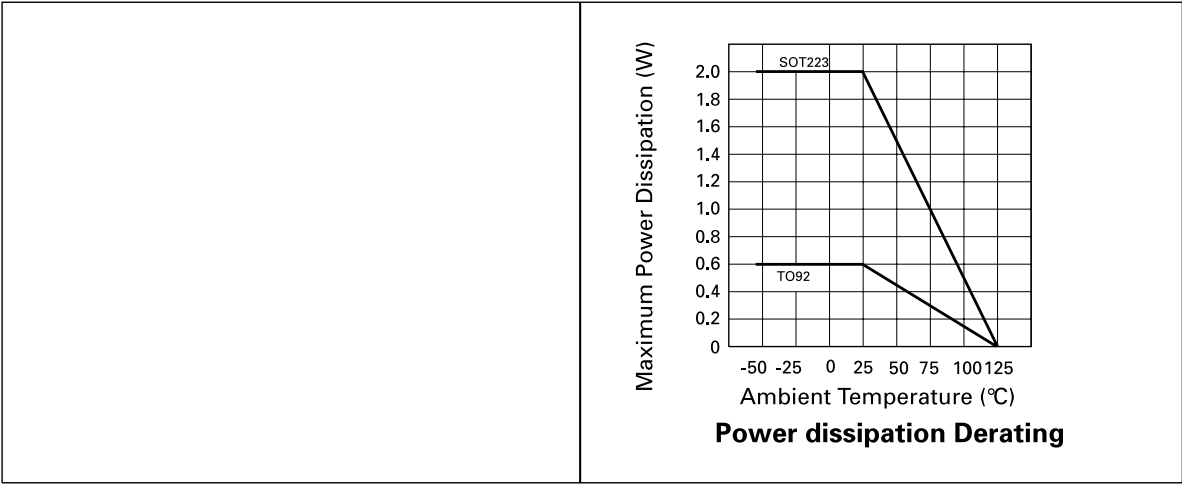

ZSR SERIES

Obsolete Variants

T092 Package suffix - C

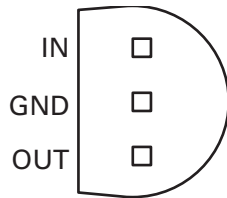

Underside view

SOT223 Order information

Orderable	Voltage	Part marking	Status	Reel size (inches)	Tape width (mm)	Quantity per reel
ZSR285GTA	2.85V	ZSR285	Obsolete	7	12	1000
ZSR400GTA	4.0V	ZSR400	Obsolete	7	12	1000
ZSR485GTA	4.85V	ZSR485	Obsolete	7	12	1000
ZSR520GTA	5.2V	ZSR520	Obsolete	7	12	1000
ZSR600GTA	6.0V	ZSR600	Obsolete	7	12	1000
ZSR900GTA	9.0V	ZSR900	Obsolete	7	12	1000

T092 Order information

Part Number	Voltage	Part marking	Status	Orderable
ZSR285	2.85V	ZSR285	Obsolete	ZSR285C*
ZSR300	3.0V	ZSR300	Obsolete	ZSR300C*
ZSR330	3.3V	ZSR330	Obsolete	ZSR330C*
ZSR400	4.0V	ZSR400	Obsolete	ZSR400C*
ZSR485	4.85V	ZSR485	Obsolete	ZSR485C*
ZSR500	5.0V	ZSR500	Obsolete	ZSR500C*
ZSR520	5.2V	ZSR520	Obsolete	ZSR520C*
ZSR600	6.0V	ZSR600	Obsolete	ZSR600C*
ZSR800	8.0V	ZSR800	Obsolete	ZSR800C*
ZSR900	9.0V	ZSR900	Obsolete	ZSR900C*
ZSR1000	10.0V	ZSR100	Obsolete	ZSR1000C*
ZSR1200	12.0V	ZSR1200	Obsolete	ZSR1200C*

NOTES:

- * T092 was supplied in the following reel options:
- | | |
|---|--------------|
| loose in boxes of 4000 | suffix: L |
| taped and wound on a reel of 1500 | suffix: STOB |
| taped and folded in concertina form of 1500 | suffix: STZ |

ZSR SERIES

ZSR285 test conditions

=6.85V

Symbol	Parameter	Conditions	Min.	Typ.	Max.	Units
V_O	Output Voltage		2.78	2.85	2.92	V
		$I_O=1$ to 200mA ^()	2.735		2.964	V
		$V_{in}=4.85$ to 20V $I_O=1$ to 100mA ^()	2.736		2.964	V
V_O	Line regulation	$V_{in}=4.85$ to 20V		10	40	mV
V_O	Load regulation	$I_O=1$ to 200mA		5	25	mV
		$I_O=1$ to 100mA		2		mV
I_g	Quiescent current	()		350	600	A
I_g	Quiescent current change	$I_O=1$ to 200mA			100	A
		$V_{in}=4.85$ to 20V			100	A
V_n	Output noise voltage	$f=10$ Hz to 10Hz		75		V rms
V_{in}/V_O	Ripple rejection	$V_{in}=5.85$ to 218V $f=120$ Hz	48	62		dB
V_{in}	Input voltage required to maintain regulation		4.85	4.55		V
V_O/T	Average temperature coefficient of V_O	$I_O=5.0$ mA ^()		0.1		mV/°C

ZSR400 test conditions (Unless otherwise stated): $T_j=25^\circ\text{C}$, $I_O=100\text{mA}$, $V_{in}=8\text{V}$

Symbol	Parameter	Conditions	Min.	Typ.	Max.	Units
V_O	Output Voltage		3.9	4.0	4.1	V
		$I_O=1$ to 200mA ^()	3.84		4.16	V
		$V_{in}=6$ to 20V $I_O=1$ to 100mA ^()	3.84		4.16	V
V_O	Line regulation	$V_{in}=6$ to 20V		10	40	mV
V_O	Load regulation	$I_O=1$ to 200mA		5	25	mV
		$I_O=1$ to 100mA		2		mV
I_g	Quiescent current	()		350	600	A
I_g	Quiescent current change	$I_O=1$ to 200mA			100	A
		$V_{in}=6$ to 20V			100	A
V_n	Output noise voltage	$f=10$ Hz to 10Hz		75		V rms
V_{in}/V_O	Ripple rejection	$V_{in}=7$ to 218V $f=120$ Hz	48	62		dB
V_{in}	Input voltage required to maintain regulation		6	5.3		V

NOTES:

() $T_j=-55$ to 125°C

ZSR SERIES

ZSR485 test conditions (Unless otherwise stated): $T_j=25^{\circ}\text{C}$, $I_O=100\text{mA}$, $V_{in}=8.85\text{V}$

V_O	Output Voltage		4.792	4.85	4.971	V
		$I_O=1$ to $200\text{mA}^{()}$	4.656		5.044	V
		$V_{in}=6.8$ to 20V $I_O=1$ to $100\text{mA}^{()}$	4.656		5.044	V
V_O	Line regulation	$V_{in}=6.85$ to 20V		10	40	mV
V_O	Load regulation	$I_O=1$ to 200mA $I_O=1$ to 100mA		5 2	25	mV mV
I_g	Quiescent current	()		350	600	A
I_g	Quiescent current change	$I_O=1$ to 200mA $V_{in}=6.85$ to 20V			100 100	A A
V_n	Output noise voltage	$f=10\text{Hz}$ to 10Hz		50		V rms
V_{in}/V_O	Ripple rejection	$V_{in}=7.85$ to 18V $f=120\text{Hz}$	50	64		dB
V_{in}	Input voltage required to maintain regulation		6.85	6.55		V
V_O/T	Average temperature coefficient of V_O	$I_O=5.0\text{mA}^{()}$		0.1		mV/ $^{\circ}\text{C}$

ZSR520 test conditions (Unless otherwise stated): $T_j=25^{\circ}\text{C}$, $I_O=100\text{mA}$, $V_{in}=100\text{mV}$

V_O	Output Voltage		5.070	5.2	5.330	V
		$I_O=1$ to $200\text{mA}^{()}$	4.99		5.41	V
		$V_{in}=7.2$ to 20V $I_O=1$ to $100\text{mA}^{()}$	4.99		5.41	V
V_O	Line regulation	$V_{in}=7.2$ to 20V		10	40	mV
V_O	Load regulation	$I_O=1$ to 200mA $I_O=1$ to 100mA		5 2	25	mV mV
I_g	Quiescent current	()		350	600	A
I_g	Quiescent current change	$I_O=1$ to 200mA $V_{in}=7.2$ to 20V			100 100	A A
V_n	Output noise voltage	$f=10\text{Hz}$ to 10Hz		75		V rms
V_{in}/V_O	Ripple rejection	$V_{in}=8.2$ to 18V $f=120\text{Hz}$	48	62		dB
V_{in}	Input voltage required to maintain regulation		7.2	6.9		V
V_O/T	Average temperature coefficient of V_O	$I_O=5.0\text{mA}^{()}$		0.1		mV/ $^{\circ}\text{C}$

() $T_j=-55$ to 125°C

ZSR SERIES

ZSR600 test conditions (Unless otherwise stated): $T_j=25^\circ\text{C}$, $I_O=100\text{mA}$, $V_{in}=10\text{V}$

Symbol	Parameter	Conditions	Min.	Typ.	Max.	Units
V_O	Output Voltage		5.85	6	6.15	V
		$I_O=1$ to $200\text{mA}^{(\tau)}$	5.76		6.24	V
		$V_{in}=8$ to 20V $I_O=1$ to $100\text{mA}^{(\tau)}$	5.76		6.24	V
ΔV_O	Line regulation	$V_{in}=8$ to 20V		10	40	mV
ΔV_O	Load regulation	$I_O=1$ to 200mA		7	30	mV
		$I_O=1$ to 100mA		2.5		mV
I_g	Quiescent current	(τ)		350	600	μA
ΔI_g	Quiescent current change	$I_O=1$ to 200mA			100	μA
		$V_{in}=8$ to 20V			100	μA
V_n	Output noise voltage	$f=10\text{Hz}$ to 10Hz		90		$\mu\text{V rms}$
$\Delta V_{in}/\Delta V_O$	Ripple rejection	$V_{in}=9$ to 18V $f=120\text{Hz}$	48	62		dB
V_{in}	Input voltage required to maintain regulation		8	7.7		V
$\Delta V_O/\Delta T$	Average temperature coefficient of V_O	$I_O=5.0\text{mA}^{(\tau)}$		0.15		$\text{mV}/^\circ\text{C}$

ZSR900 test conditions (Unless otherwise stated): $T_j=25^\circ\text{C}$, $I_O=100\text{mA}$, $V_{in}=13\text{V}$

Symbol	Parameter	Conditions	Min.	Typ.	Max.	Units
V_O	Output Voltage		8.775	9.0	9.225	V
		$I_O=1$ to $200\text{mA}^{(\tau)}$	8.64		9.36	V
		$V_{in}=11$ to 20V $I_O=1$ to $100\text{mA}^{(\tau)}$	8.64		9.36	V
ΔV_O	Line regulation	$V_{in}=11$ to 20V		12	40	mV
ΔV_O	Load regulation	$I_O=1$ to 200mA		9	30	mV
		$I_O=1$ to 100mA		3		mV
I_g	Quiescent current	(τ)		350	600	μA
ΔI_g	Quiescent current change	$I_O=1$ to 200mA			100	μA
		$V_{in}=11$ to 20V			100	μA
V_n	Output noise voltage	$f=10\text{Hz}$ to 10Hz		150		$\mu\text{V rms}$
$\Delta V_{in}/\Delta V_O$	Ripple rejection	$V_{in}=12$ to 18V $f=120\text{Hz}$	43	57		dB
V_{in}	Input voltage required to maintain regulation		11	10.7		V
$\Delta V_O/\Delta T$	Average temperature coefficient of V_O	$I_O=5.0\text{mA}^{(\tau)}$		0.25		$\text{mV}/^\circ\text{C}$

NOTES:

$(\tau) T_j=-55$ to 125°C

ZSR SERIES

Definitions

Product change

Zetex Semiconductors reserves the right to alter, without notice, specifications, design, price or conditions of supply of any product or service. Customers are solely responsible for obtaining the latest relevant information before placing orders.

Applications disclaimer

The circuits in this design/application note are offered as design ideas. It is the responsibility of the user to ensure that the circuit is fit for the user's application and meets with the user's requirements. No representation or warranty is given and no liability whatsoever is assumed by Zetex with respect to the accuracy or use of such information, or infringement of patents or other intellectual property rights arising from such use or otherwise. Zetex does not assume any legal responsibility or will not be held legally liable (whether in contract, tort (including negligence), breach of statutory duty, restriction or otherwise) for any damages, loss of profit, business, contract, opportunity or consequential loss in the use of these circuit applications, under any circumstances.

Life support

Zetex products are specifically not authorized for use as critical components in life support devices or systems without the express written approval of the Chief Executive Officer of Zetex Semiconductors plc. As used herein:

A. Life support devices or systems are devices or systems which:

1. are intended to implant into the body

or

2. support or sustain life and whose failure to perform when properly used in accordance with instructions for use provided in the labelling can be reasonably expected to result in significant injury to the user.

B. A critical component is any component in a life support device or system whose failure to perform can be reasonably expected to cause the failure of the life support device or to affect its safety or effectiveness.

Reproduction

The product specifications contained in this publication are issued to provide outline information only which (unless agreed by the company in writing) may not be used, applied or reproduced for any purpose or form part of any order or contract or be regarded as a representation relating to the products or services concerned.

Terms and Conditions

All products are sold subjects to Zetex' terms and conditions of sale, and this disclaimer (save in the event of a conflict between the two when the terms of the contract shall prevail) according to region, supplied at the time of order acknowledgement.

For the latest information on technology, delivery terms and conditions and prices, please contact your nearest Zetex sales office.

Quality of product

Zetex is an ISO 9001 and TS16949 certified semiconductor manufacturer.

To ensure quality of service and products we strongly advise the purchase of parts directly from Zetex Semiconductors or one of our regionally authorized distributors. For a complete listing of authorized distributors please visit: www.zetex.com/salesnetwork

Zetex Semiconductors does not warrant or accept any liability whatsoever in respect of any parts purchased through unauthorized sales channels.

ESD (Electrostatic discharge)

Semiconductor devices are susceptible to damage by ESD. Suitable precautions should be taken when handling and transporting devices. The possible damage to devices depends on the circumstances of the handling and transporting, and the nature of the device. The extent of damage can vary from immediate functional or parametric malfunction to degradation of function or performance in use over time. Devices suspected of being affected should be replaced.

Green compliance

Zetex Semiconductors is committed to environmental excellence in all aspects of its operations which includes meeting or exceeding regulatory requirements with respect to the use of hazardous substances. Numerous successful programs have been implemented to reduce the use of hazardous substances and/or emissions.

All Zetex components are compliant with the RoHS directive, and through this it is supporting its customers in their compliance with WEEE and ELV directives.

Product status key:

"Preview"	Future device intended for production at some point. Samples may be available
"Active"	Product status recommended for new designs
"Last time buy (LTB)"	Device will be discontinued and last time buy period and delivery is in effect
"Not recommended for new designs"	Device is still in production to support existing designs and production
"Obsolete"	Production has been discontinued

Datasheet status key:

"Draft version"	This term denotes a very early datasheet version and contains highly provisional information, which may change in any manner without notice.
"Provisional version"	This term denotes a pre-release datasheet. It provides a clear indication of anticipated performance. However, changes to the test conditions and specifications may occur, at any time and without notice.
"Issue"	This term denotes an issued datasheet containing finalized specifications. However, changes to specifications may occur, at any time and without notice.



Zetex sales offices

Europe	Americas	Asia Pacific	Corporate Headquarters
Zetex GmbH Kustermann-park Balanstraße 59 D-81541 München Germany Telephone: (49) 89 45 49 49 0 Fax: (49) 89 45 49 49 49 europe.sales@zetex.com	Zetex Inc 700 Veterans Memorial Highway Hauppauge, NY 11788 USA Telephone: (1) 631 360 2222 Fax: (1) 631 360 8222 usa.sales@zetex.com	Zetex (Asia Ltd) 3701-04 Metroplaza Tower 1 Hing Fong Road, Kwai Fong Hong Kong Telephone: (852) 26100 611 Fax: (852) 24250 494 asia.sales@zetex.com	Zetex Semiconductors plc Zetex Technology Park, Chadderton Oldham, OL9 9LL United Kingdom Telephone: (44) 161 622 4444 Fax: (44) 161 622 4446 hq@zetex.com



© 2007 Published by Zetex Semiconductors plc

Looking for pricing, stock, or lifecycle information?

Click below to explore more details on WIN SOURCE:

-  [View ZSR500C on WIN SOURCE](#)
-  [Diodes Incorporated Information](#)

Optimize Your Supply Chain with WIN SOURCE Solutions

-  Global Sourcing Solution
-  Obsolete Management
-  Cost Control Management
-  Shortage Management
-  Alternative Solution
-  Excess Inventory Management