



THE DATASHEET OF ZVP1320FTA



ZVP1320F

200V P-CHANNEL ENHANCEMENT MODE VERTICAL DMOS FET IN SOT23

Features and Benefits

- $V_{(BR)DSS} > -200V$
- $R_{DS(on)} \leq 80\Omega @ V_{GS} = -10V$
- Maximum continuous drain current $I_D = -35mA$
- **"Lead Free", RoHS Compliant (Note 1)**
- **Halogen and Antimony Free. "Green" Device (Note 2)**
- **Qualified to AEC-Q101 Standards for High Reliability**

Mechanical Data

- Case: SOT23
- Case Material: Molded Plastic, "Green" Molding Compound. UL Flammability Classification Rating 94V-0
- Moisture Sensitivity: Level 1 per J-STD-020
- Terminals: Finish – NiPdAu over Copper leadframe. Solderable per MIL-STD-202, Method 208
- Weight: 0.001 grams (approximate)

SOT23



Top View

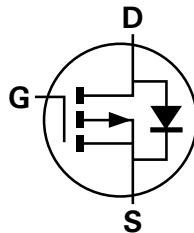

Device symbol

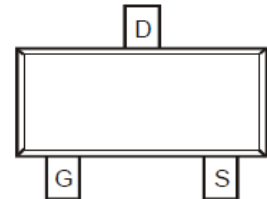

Pin-Out
Top View

Ordering Information (Note 3)

Part Number	Marking	Reel size (inches)	Tape width (mm)	Quantity per reel
ZVP1320FTA	MT	7	8	3000

- Notes:
1. No purposefully added lead
 2. Diodes Inc's "Green" policy can be found on our website at <http://www.diodes.com>.
 3. For packaging details, go to our website at <http://www.diodes.com>.

Marking Information

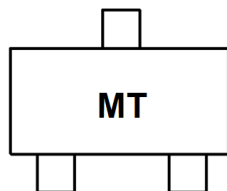

MT = Product Type Marking Code

Maximum Ratings @T_A = 25°C unless otherwise specified

Characteristic	Symbol	Value	Unit
Drain-Source Voltage	V _{DS}	-200	V
Gate-Source Voltage	V _{GS}	±20	V
Continuous Drain Current	I _D	-35	mA
Pulsed Drain Current (Note 5)	I _{DM}	-400	mA

Thermal Characteristics @T_A = 25°C unless otherwise specified

Characteristic	Symbol	Value	Unit
Power Dissipation (Note 4)	P _D	350	mW
Thermal Resistance, Junction to Ambient (Note 4)	R _{θJA}	357	°C/W
Operating and Storage Temperature Range	T _J , T _{STG}	-55 to +150	°C

- Notes:
4. For a device mounted on 25mm X 25mm X 1.6mm FR-4 PCV with high coverage of single sided 1oz copper, in still air condition.
 5. Device mounted on minimum recommended pad layout test board, 10μs pulse duty cycle = 1%.

Thermal Characteristics

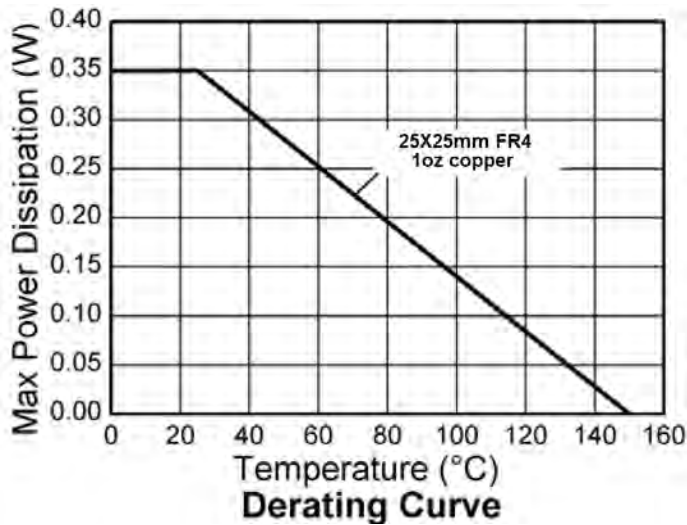
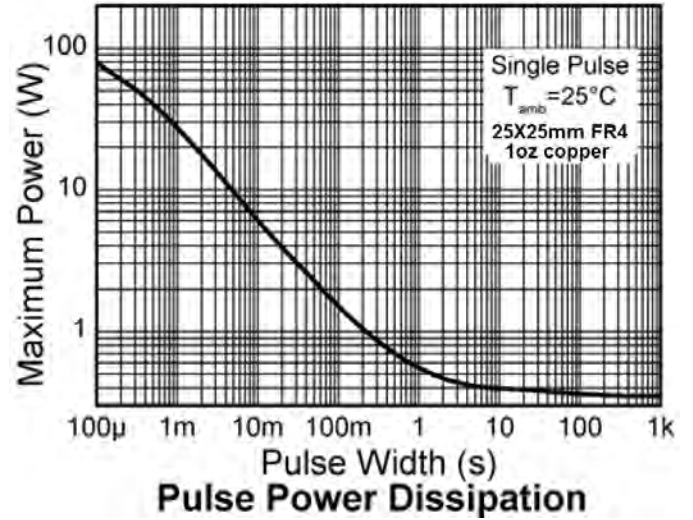
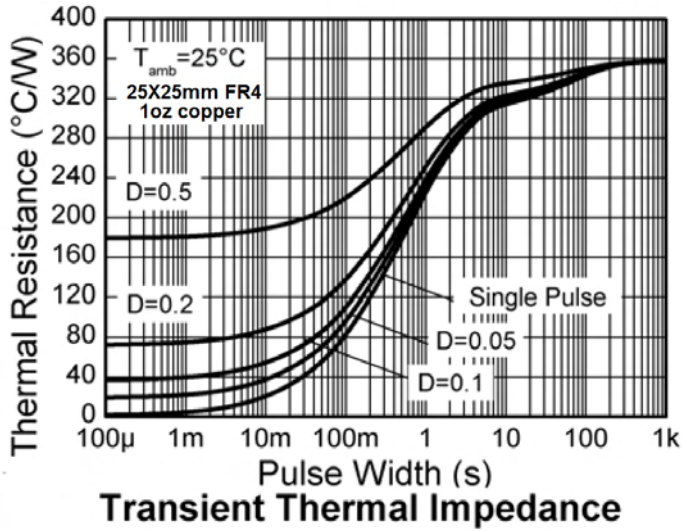

Electrical Characteristics @T_A = 25°C unless otherwise specified

Characteristic	Symbol	Min	Typ	Max	Unit	Test Condition
OFF CHARACTERISTICS (Note 6)						
Drain-Source Breakdown Voltage	BV _{DSS}	-200	-	-	V	V _{GS} = 0V, I _D = -1mA
Zero Gate Voltage Drain Current T _J = 25°C	I _{DSS}	-	-	-1 -20	μA	V _{DS} = -200V, V _{GS} = 0V V _{DS} = -160V, V _{GS} = 0V, T _A = 125°C
Gate-Source Leakage	I _{GSS}	-	-	±20	nA	V _{GS} = ±20V, V _{DS} = 0V
On-State Drain Current	I _{D(on)}	-100	-	-	mA	V _{GS} = -10V, V _{DS} = -15V
ON CHARACTERISTICS (Note 6)						
Gate Threshold Voltage	V _{GS(th)}	-1.5	-	-3.5	V	V _{DS} = V _{GS} , I _D = -1mA
Static Drain-Source On-Resistance	R _{DS(on)}	-	-	80	Ω	V _{GS} = -10V, I _D = -50mA
Forward Transconductance	g _{fs}	25	-	-	mS	V _{DS} = -15V, I _D = -50mA
DYNAMIC CHARACTERISTICS (Note 6)						
Input Capacitance	C _{iSS}	-	-	50	pF	V _{DS} = -25V, V _{GS} = 0V, f = 1.0MHz
Output Capacitance	C _{oss}	-	-	15	pF	
Reverse Transfer Capacitance	C _{rss}	-	-	5	pF	
Turn-On Delay Time	t _{D(on)}	-	-	8	ns	V _{DS} = -25V, I _D = -50mA
Turn-On Rise Time	t _r	-	-	8	ns	
Turn-Off Delay Time	t _{D(off)}	-	-	8	ns	
Turn-Off Fall Time	t _f	-	-	16	ns	

Notes: 6. Short duration pulse test used to minimize self-heating effect.

Electrical Characteristics

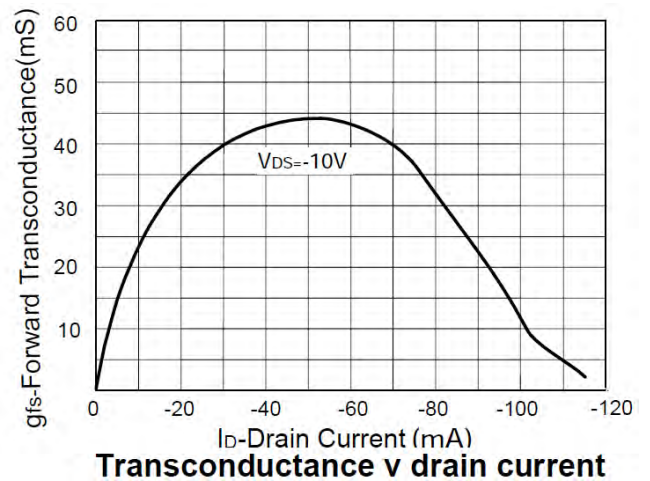
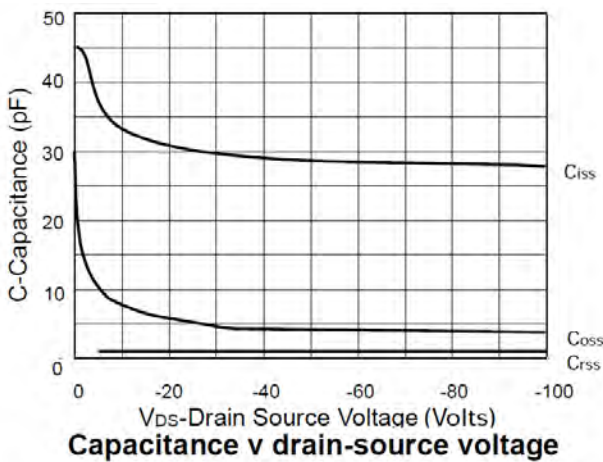
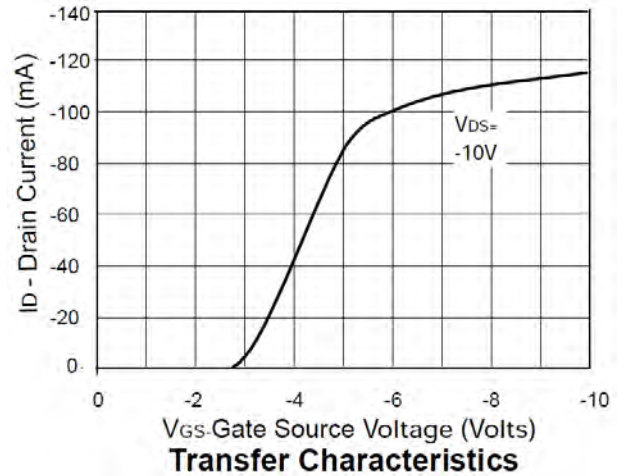
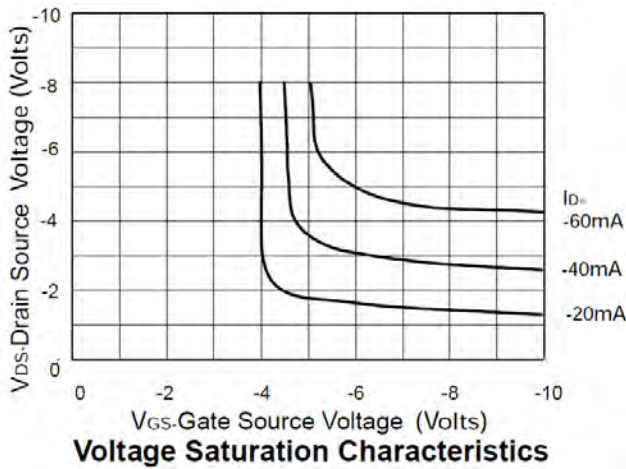
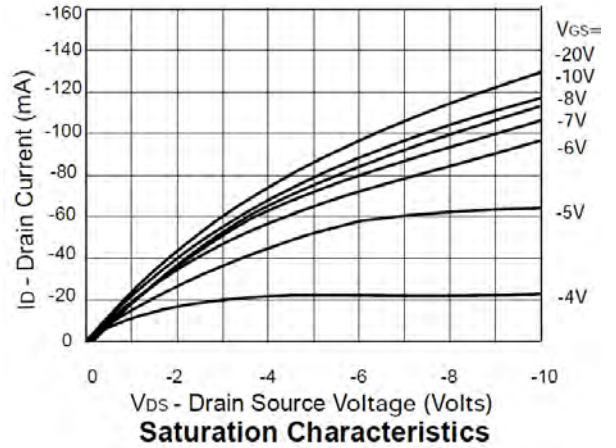
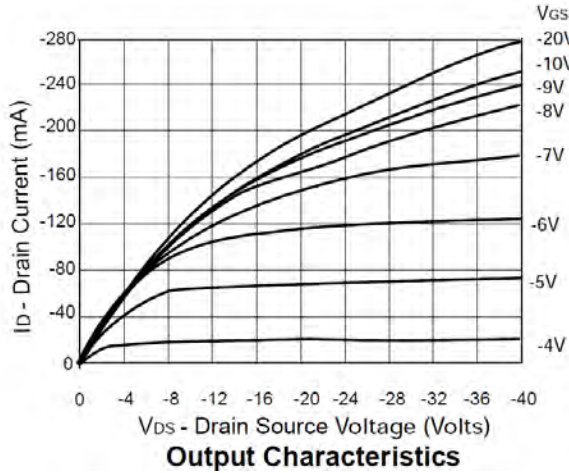

Electrical Characteristics (cont.)

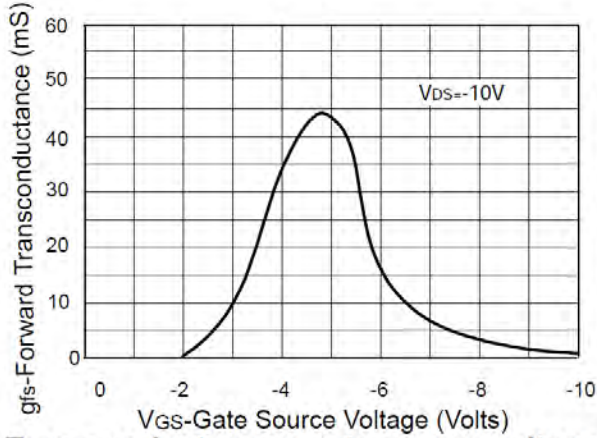

Transconductance v gate-source voltage

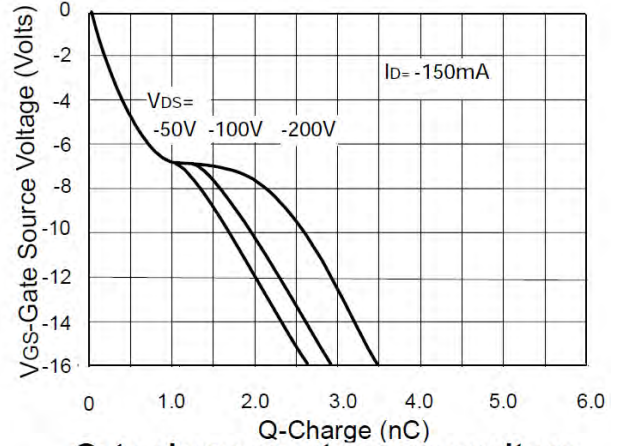

Gate charge v gate-source voltage

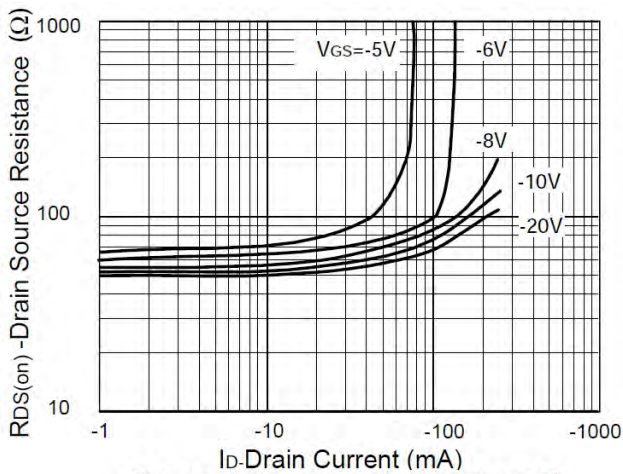

On-resistance v drain current

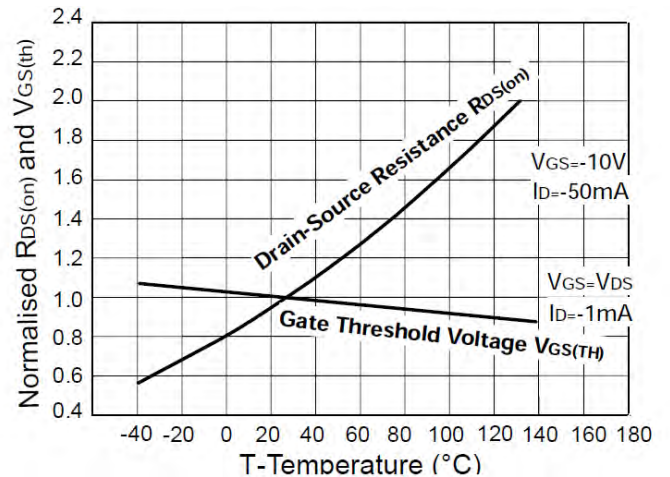

Normalised RDS(on) and VGS(th) vs Temperature

Package Outline Dimensions

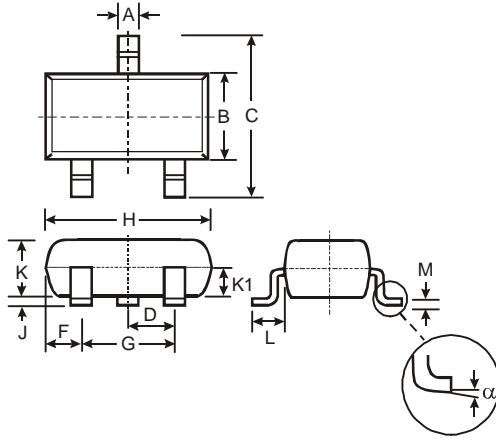

SOT23			
Dim	Min	Max	Typ
A	0.37	0.51	0.40
B	1.20	1.40	1.30
C	2.30	2.50	2.40
D	0.89	1.03	0.915
F	0.45	0.60	0.535
G	1.78	2.05	1.83
H	2.80	3.00	2.90
J	0.013	0.10	0.05
K	0.903	1.10	1.00
K1	-	-	0.400
L	0.45	0.61	0.55
M	0.085	0.18	0.11
α	0°	8°	-
All Dimensions in mm			

Suggested Pad Layout

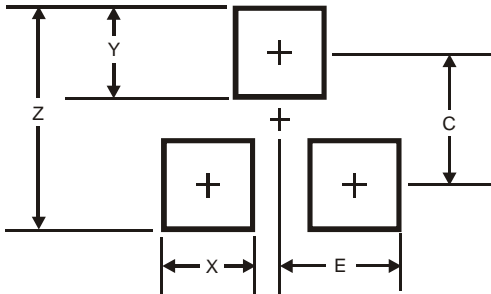

Dimensions	Value (in mm)
Z	2.9
X	0.8
Y	0.9
C	2.0
E	1.35

IMPORTANT NOTICE

DIODES INCORPORATED MAKES NO WARRANTY OF ANY KIND, EXPRESS OR IMPLIED, WITH REGARDS TO THIS DOCUMENT, INCLUDING, BUT NOT LIMITED TO, THE IMPLIED WARRANTIES OF MERCHANTABILITY AND FITNESS FOR A PARTICULAR PURPOSE (AND THEIR EQUIVALENTS UNDER THE LAWS OF ANY JURISDICTION).

Diodes Incorporated and its subsidiaries reserve the right to make modifications, enhancements, improvements, corrections or other changes without further notice to this document and any product described herein. Diodes Incorporated does not assume any liability arising out of the application or use of this document or any product described herein; neither does Diodes Incorporated convey any license under its patent or trademark rights, nor the rights of others. Any Customer or user of this document or products described herein in such applications shall assume all risks of such use and will agree to hold Diodes Incorporated and all the companies whose products are represented on Diodes Incorporated website, harmless against all damages.

Diodes Incorporated does not warrant or accept any liability whatsoever in respect of any products purchased through unauthorized sales channel. Should Customers purchase or use Diodes Incorporated products for any unintended or unauthorized application, Customers shall indemnify and hold Diodes Incorporated and its representatives harmless against all claims, damages, expenses, and attorney fees arising out of, directly or indirectly, any claim of personal injury or death associated with such unintended or unauthorized application.

Products described herein may be covered by one or more United States, international or foreign patents pending. Product names and markings noted herein may also be covered by one or more United States, international or foreign trademarks.

LIFE SUPPORT

Diodes Incorporated products are specifically not authorized for use as critical components in life support devices or systems without the express written approval of the Chief Executive Officer of Diodes Incorporated. As used herein:

A. Life support devices or systems are devices or systems which:

1. are intended to implant into the body, or
2. support or sustain life and whose failure to perform when properly used in accordance with instructions for use provided in the labeling can be reasonably expected to result in significant injury to the user.

B. A critical component is any component in a life support device or system whose failure to perform can be reasonably expected to cause the failure of the life support device or to affect its safety or effectiveness.

Customers represent that they have all necessary expertise in the safety and regulatory ramifications of their life support devices or systems, and acknowledge and agree that they are solely responsible for all legal, regulatory and safety-related requirements concerning their products and any use of Diodes Incorporated products in such safety-critical, life support devices or systems, notwithstanding any devices- or systems-related information or support that may be provided by Diodes Incorporated. Further, Customers must fully indemnify Diodes Incorporated and its representatives against any damages arising out of the use of Diodes Incorporated products in such safety-critical, life support devices or systems.

Copyright © 2012, Diodes Incorporated

www.diodes.com

Looking for pricing, stock, or lifecycle information?

Click below to explore more details on WIN SOURCE:

-  [View ZVP1320FTA on WIN SOURCE](#)
-  [Diodes Incorporated Information](#)

Optimize Your Supply Chain with WIN SOURCE Solutions

-  Global Sourcing Solution
-  Obsolete Management
-  Cost Control Management
-  Shortage Management
-  Alternative Solution
-  Excess Inventory Management