



**THE DATASHEET OF
ZXMD63N02XTA**



DUAL 20V N-CANNEL ENHANCEMENT MODE MOSFET

Product Summary

BV _{DSS}	R _{DS(ON)}	Package	I _D T _A = +25°C (Notes 5 & 6)
20V	130mΩ @ V _{GS} = 4.5V	MSOP-8	2.5A
	150mΩ @ V _{GS} = 2.7V		2.3A

Features

- Low On-Resistance
- Low Threshold
- Fast Switching Speed
- Low Gate Drive
- **Totally Lead-Free & Fully RoHS Compliant (Notes 1 & 2)**
- **Halogen and Antimony Free. "Green" Device (Note 3)**
- **Qualified to AEC-Q101 Standards for High Reliability**

Description

This MOSFET is designed to minimize the on-state resistance (R_{DS(ON)}), yet maintain superior switching performance, making it ideal for high efficiency power management applications.

Applications

- DC-DC Converters
- Power Management Functions
- Motor Control
- Disconnect Switches

Mechanical Data

- Case: MSOP-8
- Case Material: Molded Plastic, "Green" Molding Compound. UL Flammability Classification Rating 94V-0
- Moisture Sensitivity: Level 1 per J-STD-020
- Terminals: Matte Tin Finish (E3)
- Weight: 0.0277 grams (Approximate)

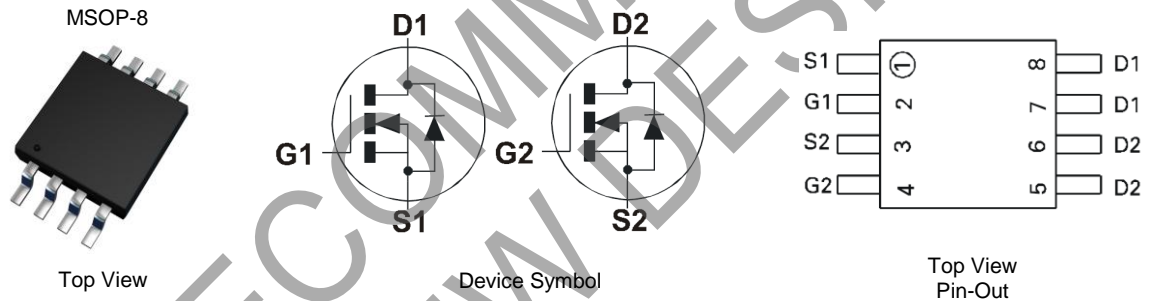

Ordering Information (Note 4)

Part Number	Marking	Reel Size (inches)	Tape Width (mm)	Quantity per Reel
ZXMD63N02XTA	ZXM63N02	7	12	1,000
ZXMD63N02XTC	ZXM63N02	13	12	4,000

- Notes:
1. No purposely added lead. Fully EU Directive 2002/95/EC (RoHS), 2011/65/EU (RoHS 2) & 2015/863/EU (RoHS 3) compliant.
 2. See <https://www.diodes.com/quality/lead-free/> for more information about Diodes Incorporated's definitions of Halogen- and Antimony-free, "Green" and Lead-free.
 3. Halogen- and Antimony-free "Green" products are defined as those which contain <900ppm bromine, <900ppm chlorine (<1500ppm total Br + Cl) and <1000ppm antimony compounds.
 4. For packaging details, go to our website at <https://www.diodes.com/design/support/packaging/diodes-packaging/>.

Marking Information

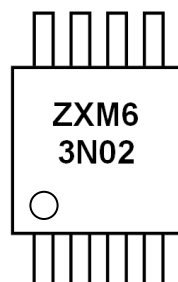

ZXM63N02 = Product Type Marking Code

Maximum Ratings (@T_A = +25°C, unless otherwise specified.)

Characteristic			Symbol	Value	Unit	
Drain-Source Voltage			V _{DSS}	20	V	
Gate-Source Voltage			V _{GSS}	±12	V	
Continuous Drain Current	Steady State	@V _{GS} = 10V; T _A = +25°C (Notes 5 & 6)	I _D	2.5	A	
		@V _{GS} = 10V; T _A = +70°C (Notes 5 & 6)		1.9		
		@V _{GS} = 10V; T _A = +100°C (Notes 5 & 6)		0.78		
Pulsed Drain Current			(Notes 6 & 7)	I _{DM}	19	A
Continuous Source Current (Body Diode)			(Notes 5 & 6)	I _S	1.5	A
Pulsed Source Current (Body Diode)			(Notes 6 & 7)	I _{SM}	19	A

Thermal Characteristics

Characteristic		Symbol	Value	Unit	
Power Dissipation	(Notes 6 & 8)	P _D	0.87	W	
	(Notes 5 & 6)		1.25		
	(Notes 8 & 9)		1.04		
Thermal Resistance, Junction to Ambient	(Notes 6 & 8)	R _{θJA}	143	°C/W	
	(Notes 5 & 6)		100		
	(Notes 8 & 9)		120		
Thermal Resistance, Junction to Leads		(Note 10)	R _{θJL}	84.9	°C/W
Operating and Storage Temperature Range		T _J , T _{STG}	-55 to +150	°C	

- Notes:
5. For a device surface mounted on FR-4 PCB measured at t ≤ 10 sec.
 6. For device with one active die.
 7. Repetitive rating – 25mm x 25mm FR-4 PCB, D = 0.02, pulse width 300µs – pulse width limited by maximum junction temperature.
 8. For a device surface mounted on 25mm x 25mm FR-4 PCB with high coverage of single sided 1oz copper, in still air conditions.
 9. For device with two active die running at equal power.
 10. Thermal resistance from junction to solder-point (at the end of the drain lead).

NOT RECOMMENDED FOR NEW DESIGN

Thermal Characteristics

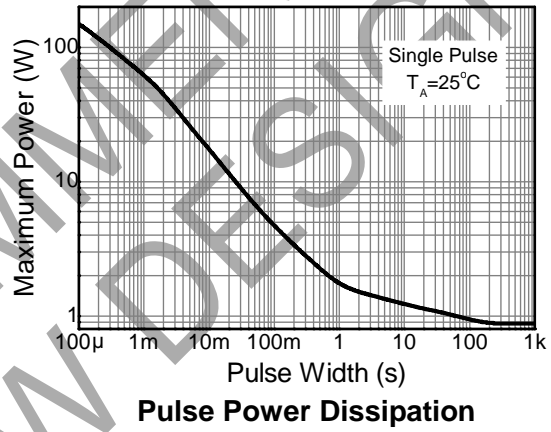
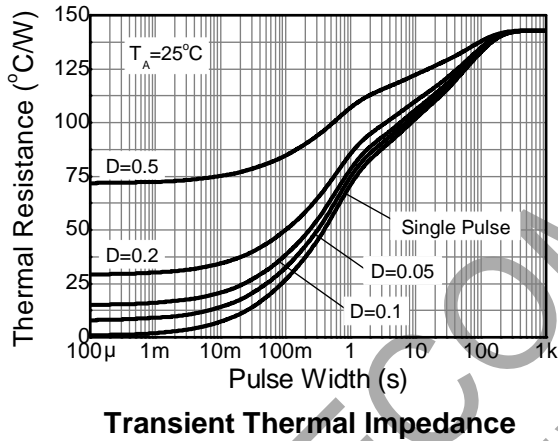
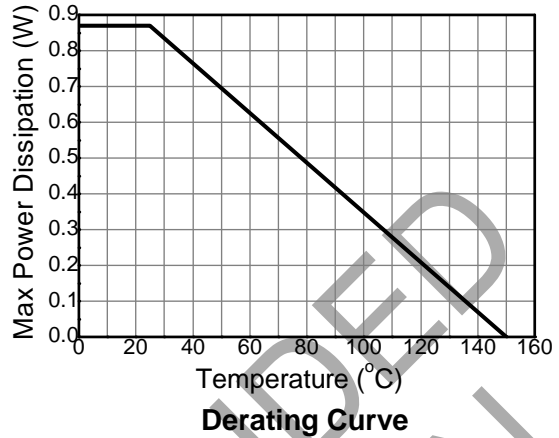
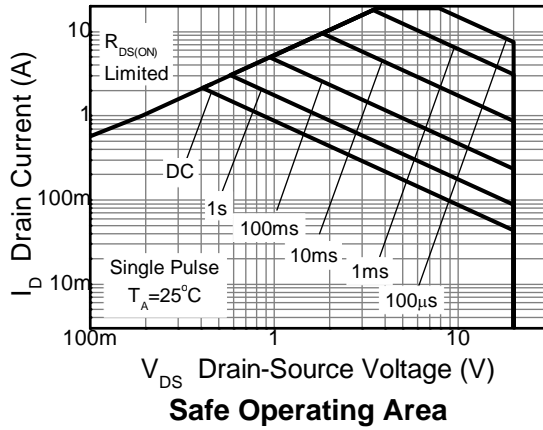

NOT RECOMMENDED FOR NEW DESIGN

Electrical Characteristics (@T_A = +25°C, unless otherwise specified.)

Characteristic	Symbol	Min	Typ	Max	Unit	Test Condition
OFF CHARACTERISTICS						
Drain-Source Breakdown Voltage	BV _{DSS}	20	—	—	V	V _{GS} = 0V, I _D = 250μA
Zero Gate Voltage Drain Current T _J = +25°C	I _{DSS}	—	—	1.0	μA	V _{DS} = 20V, V _{GS} = 0V
Gate-Source Leakage	I _{GSS}	—	—	100	nA	V _{GS} = ±12V, V _{DS} = 0V
ON CHARACTERISTICS						
Gate Threshold Voltage	V _{GS(TH)}	0.7	—	3	V	V _{DS} = V _{GS} , I _D = 250μA
Static Drain-Source On-Resistance (Note 11)	R _{DS(ON)}	—	65	130	mΩ	V _{GS} = 4.5V, I _D = 1.7A
			90	150		
Forward Transconductance (Notes 11 & 13)	g _{fs}	2.6	—	—	S	V _{DS} = 10V, I _D = 0.85A
Diodes Forward Voltage (Note 11)	V _{SD}	—	0.85	0.95	V	T _J = +25°C, I _S = 1.7A, V _{GS} = 0V
DYNAMIC CHARACTERISTICS						
Input Capacitance (Notes 12 & 13)	C _{iss}	—	350	700	pF	V _{DS} = 15V, V _{GS} = 0V, f = 1.0MHz
Output Capacitance (Notes 12 & 13)	C _{oss}	—	120	250		
Reverse Transfer Capacitance (Notes 12 & 13)	C _{rss}	—	50	100		
Gate Resistance (Notes 12 & 13)	R _g	—	3.8	7.6	Ω	f = 1MHz, V _{GS} = 0V, V _{DS} = 0V
Total Gate Charge (Notes 12 & 13)	Q _g	—	4.5	6	nC	V _{GS} = 4.5V, V _{DS} = 16V, I _D = 1.7A
Gate-Source Charge (Notes 12 & 13)	Q _{gs}	—	0.5	0.65		
Gate-Drain Charge (Notes 12 & 13)	Q _{gd}	—	2	2.5		
Reverse Recovery Time (Note 13)	t _{RR}	—	15	30	ns	T _J = +25°C, I _F = 1.7A, di/dt = 100A/μs
Reverse Recovery Charge (Note 13)	Q _{RR}	—	5.9	—	nC	
Turn-On Delay Time (Notes 12 & 13)	t _{D(ON)}	—	3.4	—	ns	V _{DD} = 10V, I _D = 1.7A, R _G = 6Ω, R _D = 5.7Ω
Turn-On Rise Time (Notes 12 & 13)	t _r	—	8.1	—		
Turn-Off Delay Time (Notes 12 & 13)	t _{D(OFF)}	—	13.5	—		
Turn-Off Fall Time (Notes 12 & 13)	t _f	—	9.1	—		

Notes: 11. Measured under pulsed conditions. Pulse width ≤ 300μs; duty cycle ≤ 2%.
 12. Switching characteristics are independent of operating junction temperature.
 13. For design aid only, not subject to production testing.

NOT RECOMMENDED FOR NEW DESIGN

Typical Characteristics

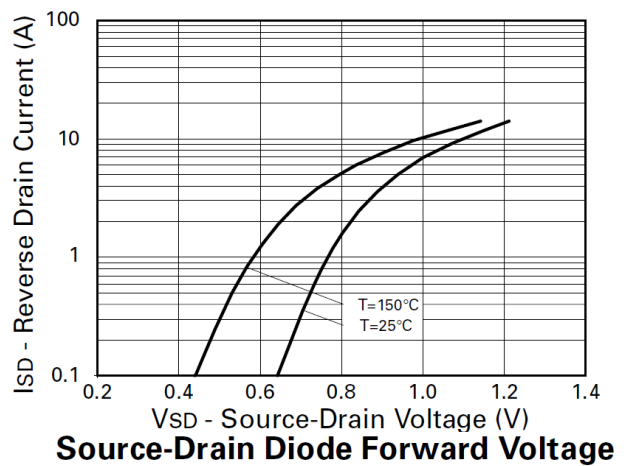
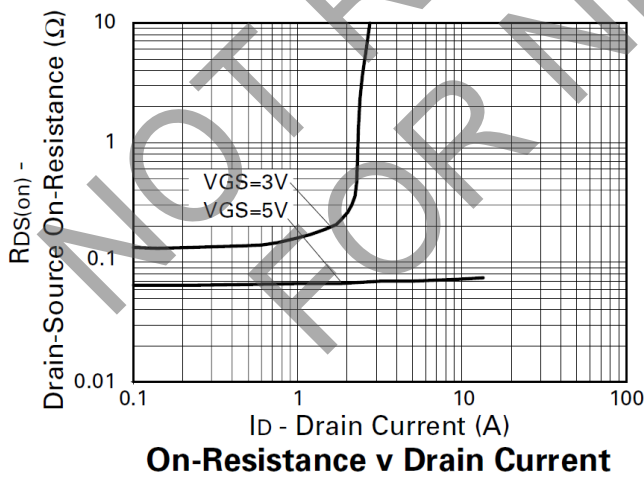
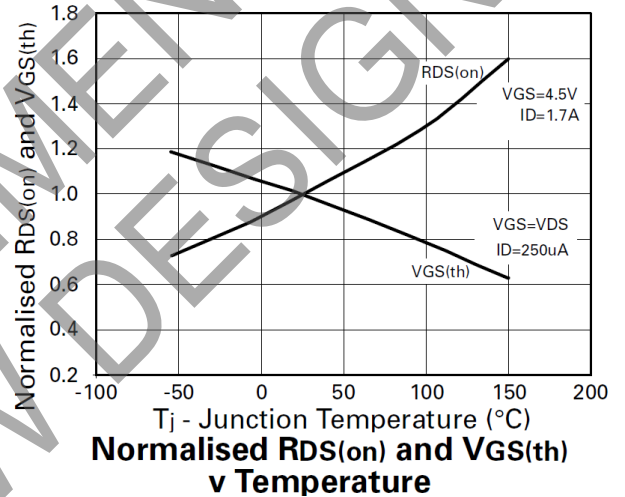
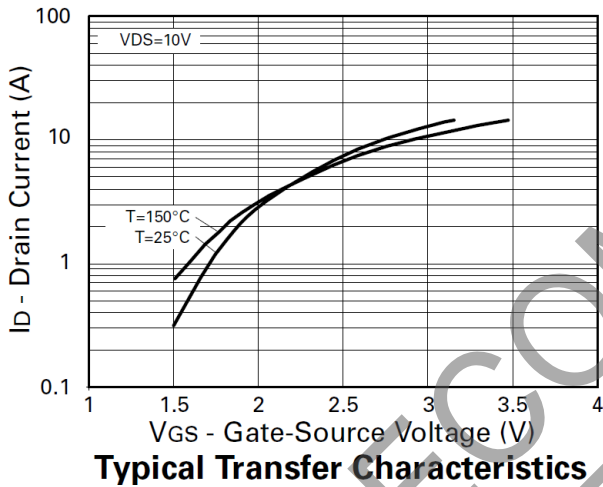
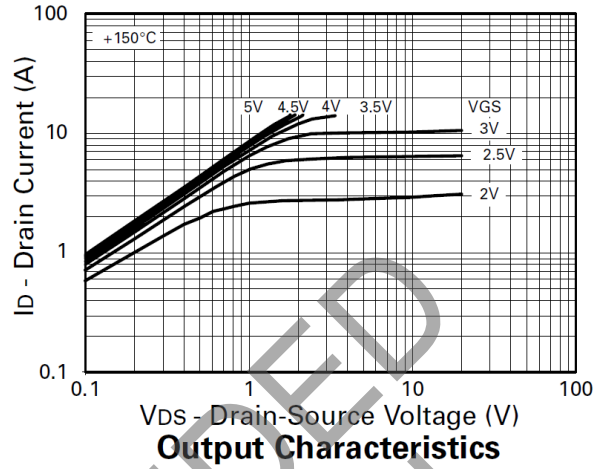
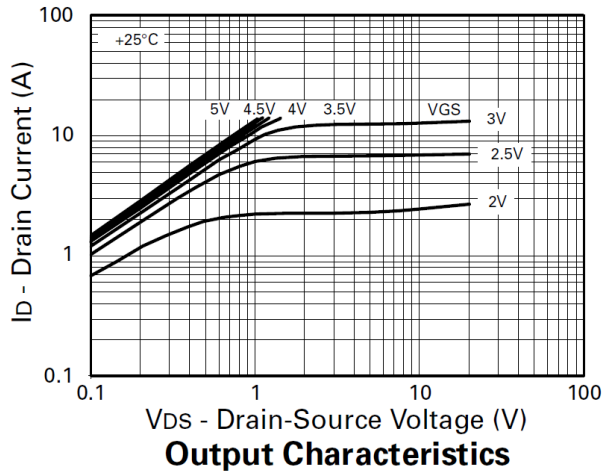

Typical Characteristics (Cont.)

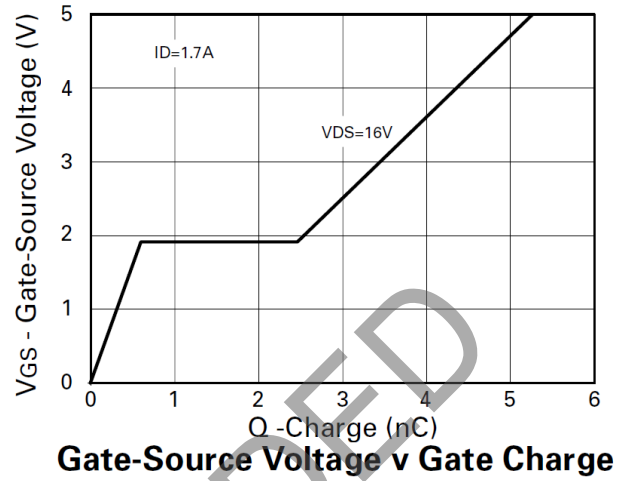
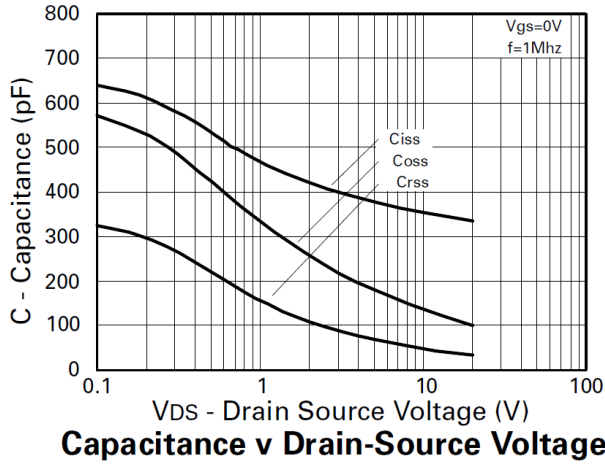

Test Circuits

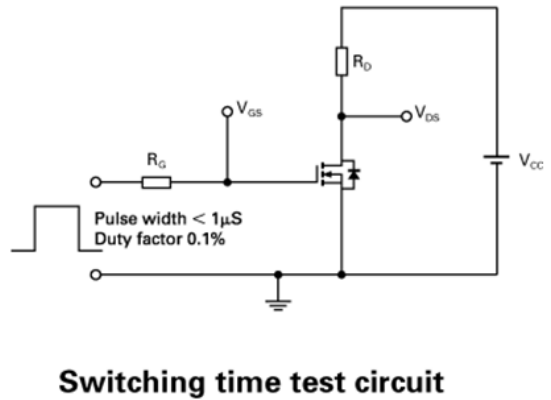
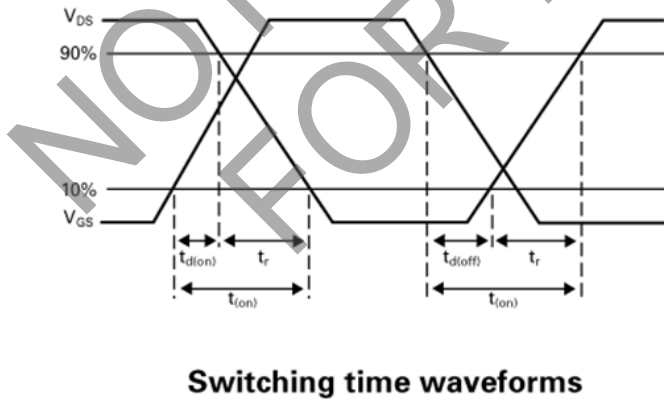
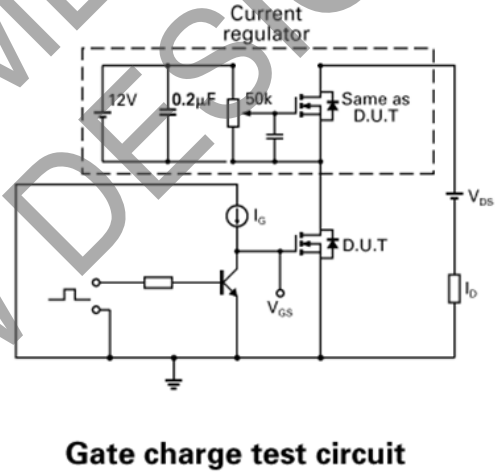
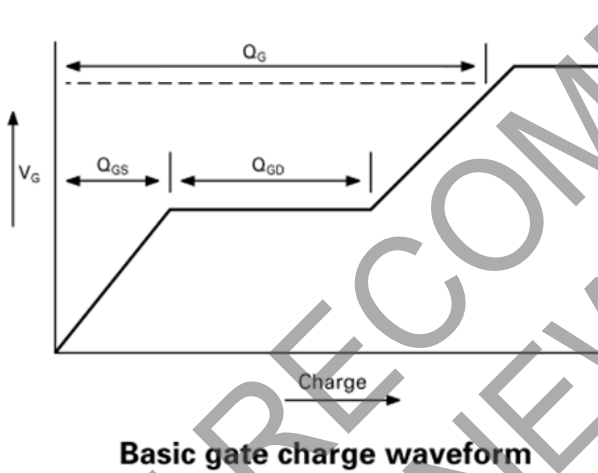

Package Outline Dimensions

Please see <http://www.diodes.com/package-outlines.html> for the latest version.

MSOP-8

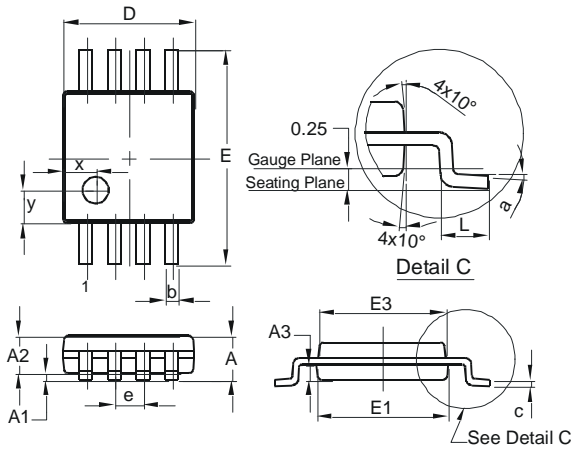

MSOP-8			
Dim	Min	Max	Typ
A	—	1.10	—
A1	0.05	0.15	0.10
A2	0.75	0.95	0.86
A3	0.29	0.49	0.39
b	0.22	0.38	0.30
c	0.08	0.23	0.15
D	2.90	3.10	3.00
E	4.70	5.10	4.90
E1	2.90	3.10	3.00
E3	2.85	3.05	2.95
e	—	—	0.65
L	0.40	0.80	0.60
a	0°	8°	4°
x	—	—	0.750
y	—	—	0.750
All Dimensions in mm			

Suggested Pad Layout

Please see <http://www.diodes.com/package-outlines.html> for the latest version.

MSOP-8

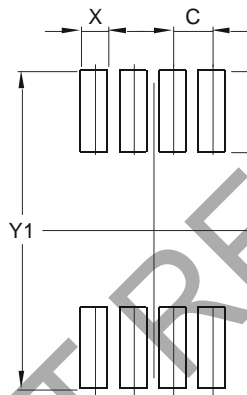

Dimensions	Value (in mm)
C	0.650
X	0.450
Y	1.350
Y1	5.300

NOT RECOMMENDED FOR NEW DESIGN

IMPORTANT NOTICE

DIODES INCORPORATED MAKES NO WARRANTY OF ANY KIND, EXPRESS OR IMPLIED, WITH REGARDS TO THIS DOCUMENT, INCLUDING, BUT NOT LIMITED TO, THE IMPLIED WARRANTIES OF MERCHANTABILITY AND FITNESS FOR A PARTICULAR PURPOSE (AND THEIR EQUIVALENTS UNDER THE LAWS OF ANY JURISDICTION).

Diodes Incorporated and its subsidiaries reserve the right to make modifications, enhancements, improvements, corrections or other changes without further notice to this document and any product described herein. Diodes Incorporated does not assume any liability arising out of the application or use of this document or any product described herein; neither does Diodes Incorporated convey any license under its patent or trademark rights, nor the rights of others. Any Customer or user of this document or products described herein in such applications shall assume all risks of such use and will agree to hold Diodes Incorporated and all the companies whose products are represented on Diodes Incorporated website, harmless against all damages.

Diodes Incorporated does not warrant or accept any liability whatsoever in respect of any products purchased through unauthorized sales channel. Should Customers purchase or use Diodes Incorporated products for any unintended or unauthorized application, Customers shall indemnify and hold Diodes Incorporated and its representatives harmless against all claims, damages, expenses, and attorney fees arising out of, directly or indirectly, any claim of personal injury or death associated with such unintended or unauthorized application.

Products described herein may be covered by one or more United States, international or foreign patents pending. Product names and markings noted herein may also be covered by one or more United States, international or foreign trademarks.

This document is written in English but may be translated into multiple languages for reference. Only the English version of this document is the final and determinative format released by Diodes Incorporated.

LIFE SUPPORT

Diodes Incorporated products are specifically not authorized for use as critical components in life support devices or systems without the express written approval of the Chief Executive Officer of Diodes Incorporated. As used herein:

A. Life support devices or systems are devices or systems which:

1. are intended to implant into the body, or
2. support or sustain life and whose failure to perform when properly used in accordance with instructions for use provided in the labeling can be reasonably expected to result in significant injury to the user.

B. A critical component is any component in a life support device or system whose failure to perform can be reasonably expected to cause the failure of the life support device or to affect its safety or effectiveness.

Customers represent that they have all necessary expertise in the safety and regulatory ramifications of their life support devices or systems, and acknowledge and agree that they are solely responsible for all legal, regulatory and safety-related requirements concerning their products and any use of Diodes Incorporated products in such safety-critical, life support devices or systems, notwithstanding any devices- or systems-related information or support that may be provided by Diodes Incorporated. Further, Customers must fully indemnify Diodes Incorporated and its representatives against any damages arising out of the use of Diodes Incorporated products in such safety-critical, life support devices or systems.

Copyright © 2018, Diodes Incorporated

www.diodes.com

Looking for pricing, stock, or lifecycle information?

Click below to explore more details on WIN SOURCE:

- ⊖ [View ZXMD63N02XTA on WIN SOURCE](#)
- ⊖ [Diodes Incorporated Information](#)

Optimize Your Supply Chain with WIN SOURCE Solutions

- ✓ Global Sourcing Solution
- ✓ Obsolete Management
- ✓ Cost Control Management
- ✓ Shortage Management
- ✓ Alternative Solution
- ✓ Excess Inventory Management