



THE DATASHEET OF ZXMN20B28KTC



Product Summary

BV _{DSS}	R _{DS(ON)} MAX	I _D T _A = 25°C
200V	750mΩ @ V _{GS} = 10V	2.3A
	780mΩ @ V _{GS} = 5V	2.2A

Description and Applications

This MOSFET features low on-resistance, fast switching and a high avalanche withstand capability, making it ideal for high-efficiency power management applications.

- SLIC line drivers for VoIP applications
- Transformer driving switch
- Power management functions
- Motor control
- Uninterrupted power supply

Features and Benefits

- 100% Unclamped Inductive Switch (UIS) test in production
- High avalanche energy pulse withstand capability
- Low gate drive voltage (Logic level capable)
- Low input capacitance
- Low on-resistance
- Fast switching speed
- **Lead-Free Finish; RoHS Compliant (Notes 1 & 2)**
- **Halogen and Antimony Free. "Green" Device (Note 3)**
- **For automotive applications requiring specific change control (i.e. parts qualified to AEC-Q100/101/200, PPAP capable, and manufactured in IATF 16949 certified facilities), please [contact us](mailto:contact@diodes.com) or your local Diodes representative. <https://www.diodes.com/quality/product-definitions/>**

Mechanical Data

- Case: TO252
- Case Material: Molded Plastic "Green" Molding Compound, UL Flammability Classification Rating 94V-0 (Note 1)
- Moisture Sensitivity: Level 1 per J-STD-020
- Terminal Connections: See Diagram
- Terminals: Matte Tin Finish Annealed over Copper Leadframe. Solderable per MIL-STD-202, Method 208
- Weight: 0.33 grams (Approximate)

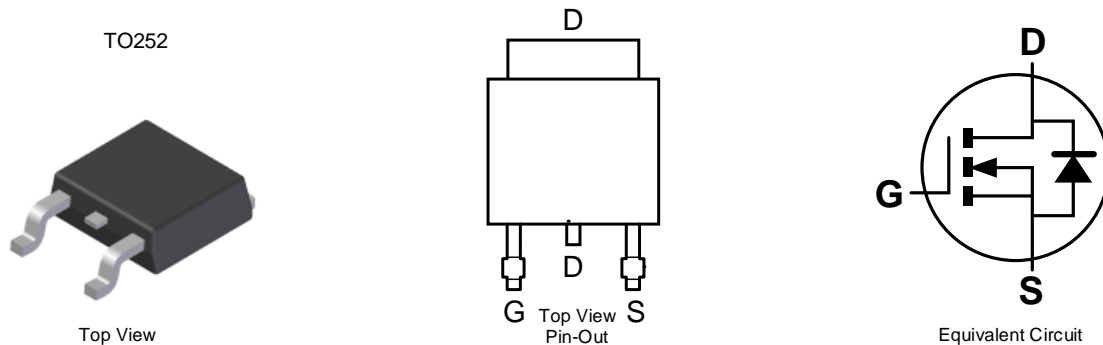

Ordering Information (Note 4)

Part Number	Case	Packaging
ZXMN20B28KTC	TO252 (DPAK)	2,500/Tape & Reel

- Notes:
1. EU Directive 2002/95/EC (RoHS), 2011/65/EU (RoHS 2) & 2015/863/EU (RoHS 3) compliant. All applicable RoHS exemptions applied.
 2. See <https://www.diodes.com/quality/lead-free/> for more information about Diodes Incorporated's definitions of Halogen- and Antimony-free, "Green" and Lead-free.
 3. Halogen- and Antimony-free "Green" products are defined as those which contain <900ppm bromine, <900ppm chlorine (<1500ppm total Br + Cl) and <1000ppm antimony compounds.
 4. For packaging details, go to our website at <https://www.diodes.com/design/support/packaging/diodes-packaging/>.

Marking Information

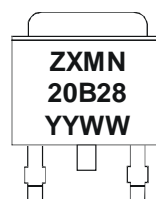

ZXMN = Product Type Marking Code, Line 1
 20B28 = Product Type Marking Code, Line 2
 YYWW = Date Code Marking
 YY = Year (ex: 21 = 2021)
 WW = Week (01 to 53)

Maximum Ratings (@ $T_A = 25^\circ\text{C}$, unless otherwise specified)

Characteristic		Symbol	Value	Unit	
Drain-Source voltage		V_{DSS}	200	V	
Gate-Source voltage		V_{GS}	± 20	V	
Single Pulsed Avalanche Energy	(Note 10)	E_{AS}	73	mJ	
Single Pulsed Avalanche Current	(Note 10)	I_{AS}	5.5	A	
Repetitive Avalanche Energy	(Note 7)	E_{AR}	4.5	mJ	
Repetitive Avalanche Current	(Note 7)	I_{AR}	5.5	A	
Continuous Drain current	$V_{GS} = 10\text{V}$ $T_A = 70^\circ\text{C}$ (Note 6) (Note 5)	I_D	2.3	A	
			1.8		
Pulsed Drain current	$V_{GS} = 10\text{V}$ (Note 7)	I_{DM}	17.3	A	
Continuous Source current (Body diode)		(Note 5)	I_S	2.3	A
Pulsed Source current (Body diode)		(Note 7)	I_{SM}	17.3	A

Thermal Characteristics (@ $T_A = +25^\circ\text{C}$, unless otherwise specified.)

Characteristic		Symbol	Value	Unit
Power dissipation Linear derating factor	(Note 5)	P_D	4.3	W mW/ $^\circ\text{C}$
			34.4	
	(Note 6)		10.2	
	(Note 9)		76.0	
Thermal Resistance, Junction to Ambient	(Note 5)	$R_{\theta JA}$	2.2	$^\circ\text{C/W}$
	(Note 6)		17.4	
	(Note 9)		29.1	
Thermal Resistance, Junction to Lead	(Note 8)	$R_{\theta JL}$	12.3	$^\circ\text{C/W}$
			57.3	
Operating and storage temperature range		T_J, T_{STG}	-55 to 150	$^\circ\text{C}$

- Notes:
- For a device surface mounted on 50mm x 50mm x 1.6mm FR4 PCB with high coverage of single sided 2oz copper, in still air conditions; the device is measured when operating in a steady-state condition.
 - Same as note 2, except the device is measured at $t \leq 10$ sec.
 - Same as note 2, except the device is operating in a repetitive state with pulse width and duty cycle limited by maximum junction temperature.
 - Thermal resistance from junction to solder-point (at the end of the drain lead).
 - For a device surface mounted on 25mm x 25mm x 1.6mm FR4 PCB with the high coverage single sided 1oz copper, in still air conditions; the device is measured when operating in a steady-state condition.
 - UIS in production with $L = 4.83\text{mH}$, $I_{AS} = 5.5\text{A}$, $R_G = 25\Omega$, $V_{DD} = 100\text{V}$, starting $T_J = 25^\circ\text{C}$.

Thermal Characteristics

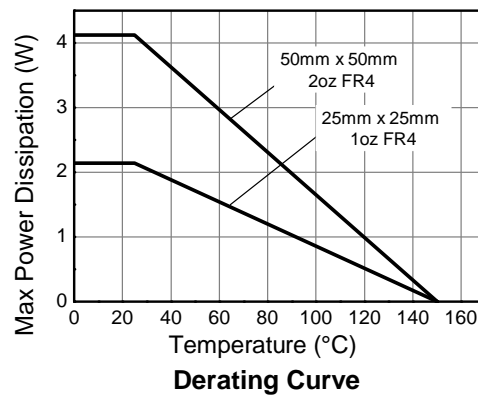
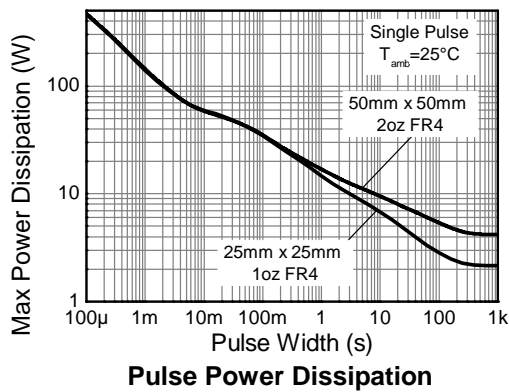
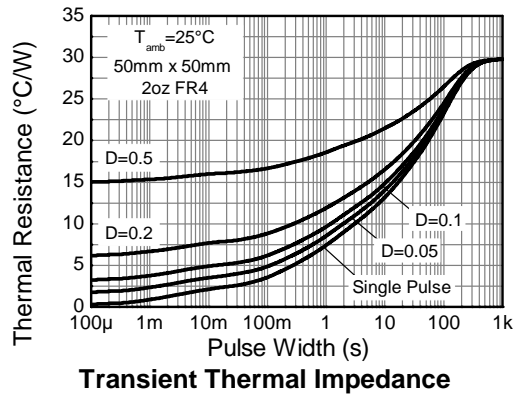
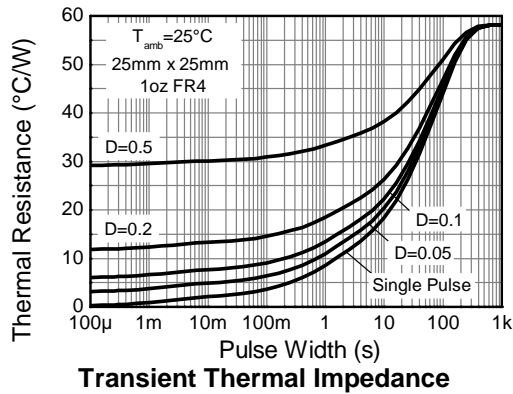
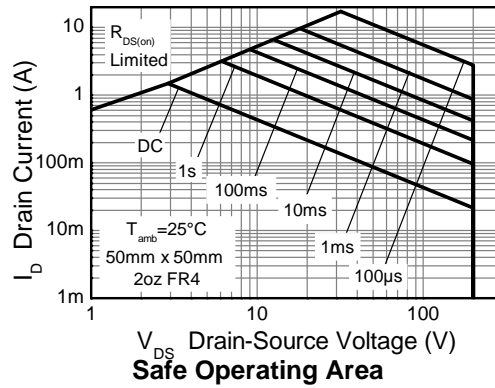
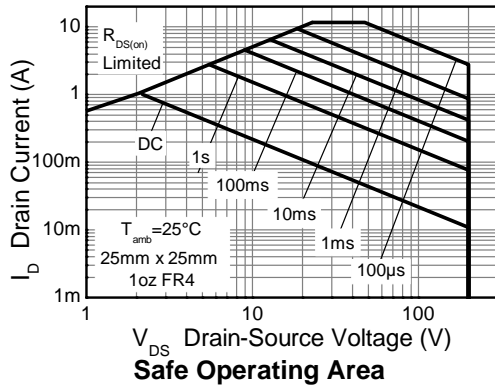

Electrical Characteristics (@T_A = 25°C, unless otherwise specified.)

Characteristic	Symbol	Min	Typ	Max	Unit	Test Condition
OFF CHARACTERISTICS (Note 11)						
Drain-Source Breakdown Voltage	BV _{DSS}	200	—	—	V	I _D = 250μA, V _{GS} = 0V
Zero Gate Voltage Drain Current	I _{DSS}	—	—	500	nA	V _{DS} = 200V, V _{GS} = 0V
Gate-Source Leakage	I _{GSS}	—	—	±100	nA	V _{GS} = ±20V, V _{DS} = 0V
ON CHARACTERISTICS (Note 11)						
Gate Threshold Voltage	V _{GS(th)}	1	1.6	2.5	V	I _D = 250μA, V _{DS} = V _{GS}
Static Drain-Source On-Resistance (Note 12)	R _{DS(on)}	—	0.650	0.750	Ω	V _{GS} = 10V, I _D = 2.75A
			0.670	0.780		V _{GS} = 5V, I _D = 2.75A
Forward Transconductance (Notes 12 & 13)	g _{fs}	—	6.13	—	S	V _{DS} = 30V, I _D = 2.75A
Diode Forward Voltage (Note 12)	V _{SD}	—	0.860	0.950	V	I _S = 5.5A, V _{GS} = 0V
Reverse recovery time (Note 13)	t _{rr}	—	177	—	ns	I _S = 6.5A, V _{GS} = 0V,
Reverse recovery charge (Note 13)	Q _{rr}	—	1.4	—	μC	di/dt = 100A/μs
DYNAMIC CHARACTERISTICS (Note 13)						
Input Capacitance	C _{iss}	—	358	—	pF	V _{DS} = 25V, V _{GS} = 0V f = 1MHz
Output Capacitance	C _{oss}	—	50	—	pF	
Reverse Transfer Capacitance	C _{rss}	—	6.1	—	pF	
Total Gate Charge	Q _g	—	8.1	—	nC	V _{DS} = 120V, V _{GS} = 5V I _D = 6.5A
Gate-Source Charge	Q _{gs}	—	1.4	—	nC	
Gate-Drain Charge	Q _{gd}	—	3.9	—	nC	
Turn-On Delay Time (Note 14)	t _{D(on)}	—	17.8	—	ns	V _{DD} = 100V, V _{GS} = 5V I _D = 6.5A, R _G ≅ 25Ω
Turn-On Rise Time (Note 14)	t _r	—	76.9	—	ns	
Turn-Off Delay Time (Note 14)	t _{D(off)}	—	44.7	—	ns	
Turn-Off Fall Time (Note 14)	t _f	—	57.1	—	ns	

- Notes:
11. Short duration pulse test used to minimize self-heating effect.
 12. Measured under pulsed conditions. Pulse width ≤ 300μs; duty cycle ≤ 2%
 13. For design aid only, not subject to production testing.
 14. Switching characteristics are independent of operating junction temperatures.

Typical Characteristics

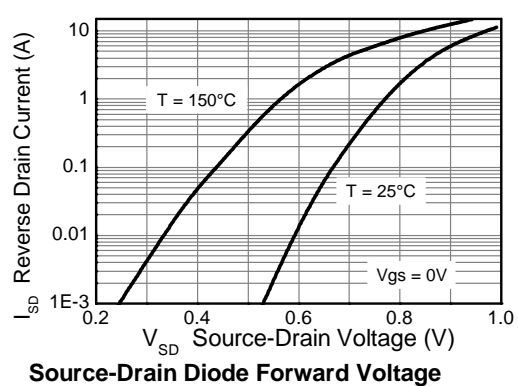
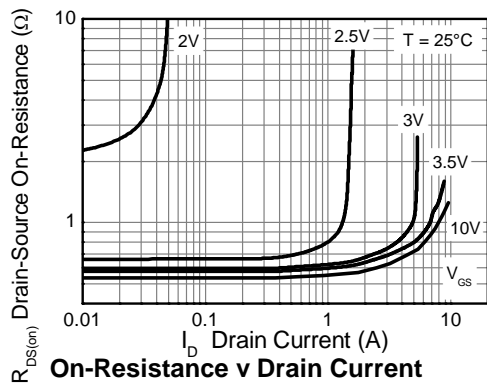
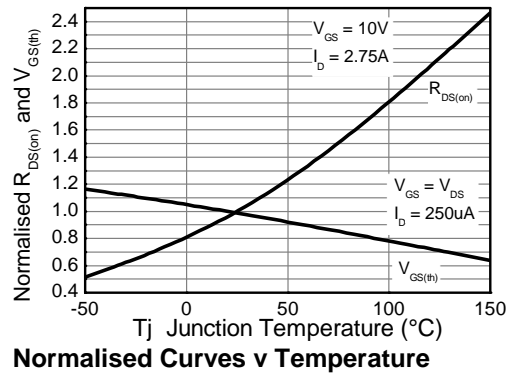
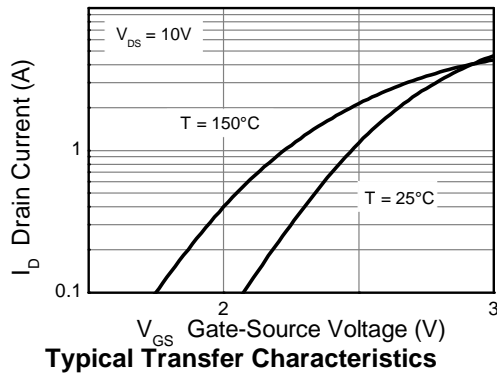
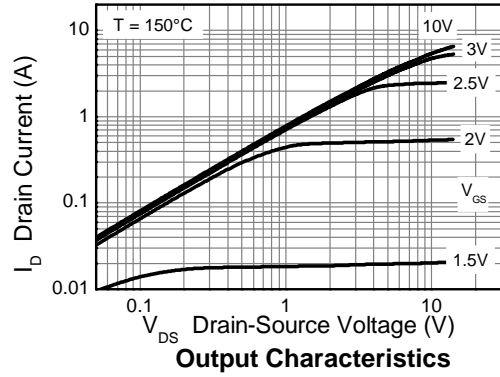
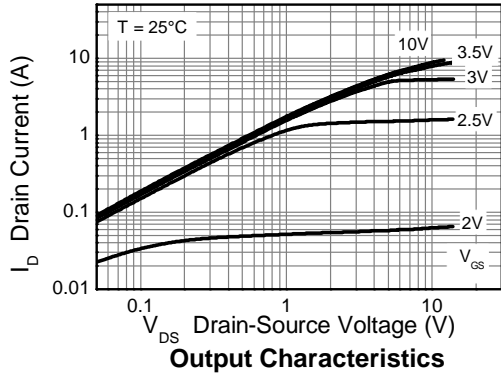

Typical Characteristics (continued)

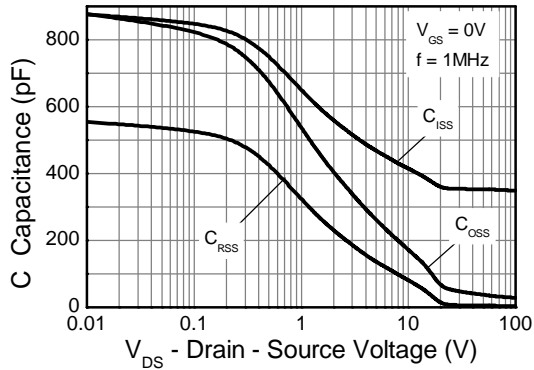

Capacitance v Drain-Source Voltage

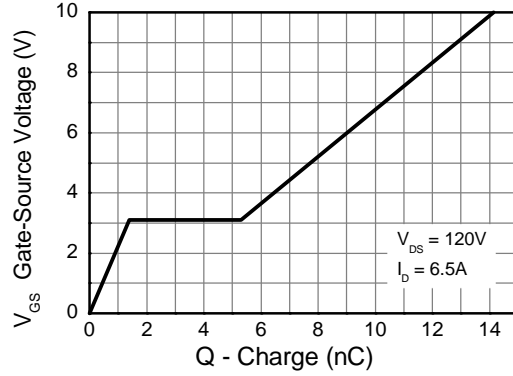

Gate-Source Voltage v Gate Charge

Test Circuits

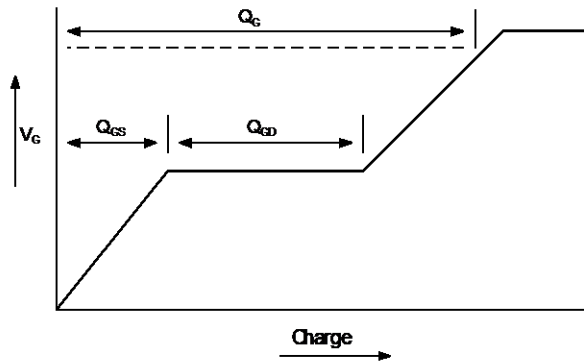

Basic gate charge waveform

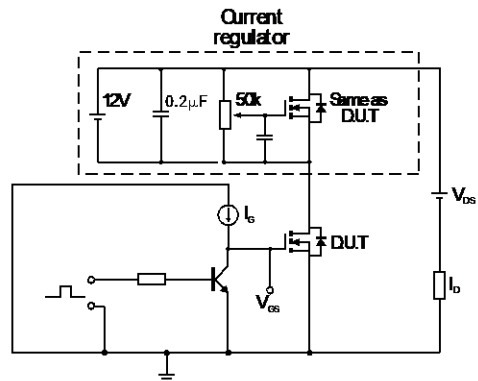

Gate charge test circuit

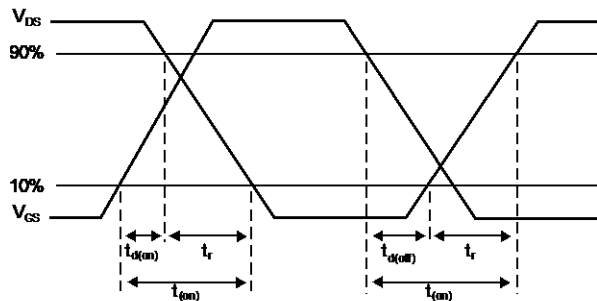

Switching time waveforms

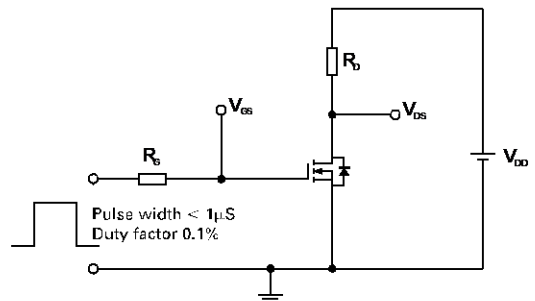

Switching time test circuit

Package Outline Dimensions

Please see <http://www.diodes.com/package-outlines.html> for the latest version.

TO252 (DPAK)

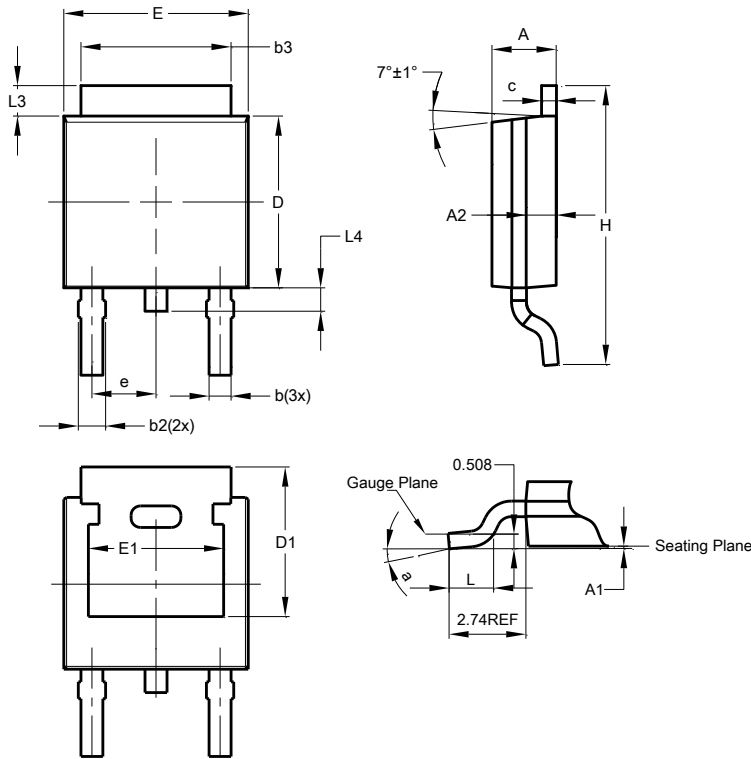

TO252 (DPAK)			
Dim	Min	Max	Typ
A	2.19	2.39	2.29
A1	0.00	0.13	0.08
A2	0.97	1.17	1.07
b	0.64	0.88	0.783
b2	0.76	1.14	0.95
b3	5.21	5.46	5.33
c	0.45	0.58	0.531
D	6.00	6.20	6.10
D1	5.21	-	-
e	-	-	2.286
E	6.45	6.70	6.58
E1	4.32	-	-
H	9.40	10.41	9.91
L	1.40	1.78	1.59
L3	0.88	1.27	1.08
L4	0.64	1.02	0.83
a	0°	10°	-
All Dimensions in mm			

Suggested Pad Layout

Please see <http://www.diodes.com/package-outlines.html> for the latest version.

TO252 (DPAK)

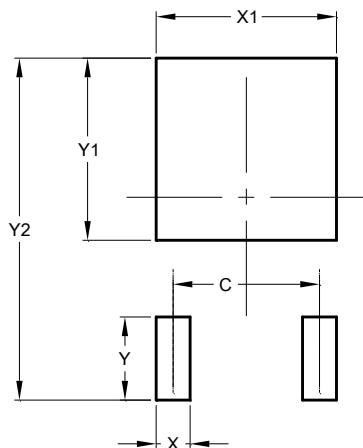

Dimensions	Value (in mm)
C	4.572
X	1.060
X1	5.632
Y	2.600
Y1	5.700
Y2	10.700

IMPORTANT NOTICE

1. DIODES INCORPORATED AND ITS SUBSIDIARIES ("DIODES") MAKE NO WARRANTY OF ANY KIND, EXPRESS OR IMPLIED, WITH REGARDS TO ANY INFORMATION CONTAINED IN THIS DOCUMENT, INCLUDING, BUT NOT LIMITED TO, THE IMPLIED WARRANTIES OF MERCHANTABILITY, FITNESS FOR A PARTICULAR PURPOSE OR NON-INFRINGEMENT OF THIRD PARTY INTELLECTUAL PROPERTY RIGHTS (AND THEIR EQUIVALENTS UNDER THE LAWS OF ANY JURISDICTION).
2. The Information contained herein is for informational purpose only and is provided only to illustrate the operation of Diodes products described herein and application examples. Diodes does not assume any liability arising out of the application or use of this document or any product described herein. This document is intended for skilled and technically trained engineering customers and users who design with Diodes products. Diodes products may be used to facilitate safety-related applications; however, in all instances customers and users are responsible for (a) selecting the appropriate Diodes products for their applications, (b) evaluating the suitability of the Diodes products for their intended applications, (c) ensuring their applications, which incorporate Diodes products, comply the applicable legal and regulatory requirements as well as safety and functional-safety related standards, and (d) ensuring they design with appropriate safeguards (including testing, validation, quality control techniques, redundancy, malfunction prevention, and appropriate treatment for aging degradation) to minimize the risks associated with their applications.
3. Diodes assumes no liability for any application-related information, support, assistance or feedback that may be provided by Diodes from time to time. Any customer or user of this document or products described herein will assume all risks and liabilities associated with such use, and will hold Diodes and all companies whose products are represented herein or on Diodes' websites, harmless against all damages and liabilities.
4. Products described herein may be covered by one or more United States, international or foreign patents and pending patent applications. Product names and markings noted herein may also be covered by one or more United States, international or foreign trademarks and trademark applications. Diodes does not convey any license under any of its intellectual property rights or the rights of any third parties (including third parties whose products and services may be described in this document or on Diodes' website) under this document.
5. Diodes products are provided subject to Diodes' Standard Terms and Conditions of Sale (<https://www.diodes.com/about/company/terms-and-conditions/terms-and-conditions-of-sales/>) or other applicable terms. This document does not alter or expand the applicable warranties provided by Diodes. Diodes does not warrant or accept any liability whatsoever in respect of any products purchased through unauthorized sales channel.
6. Diodes products and technology may not be used for or incorporated into any products or systems whose manufacture, use or sale is prohibited under any applicable laws and regulations. Should customers or users use Diodes products in contravention of any applicable laws or regulations, or for any unintended or unauthorized application, customers and users will (a) be solely responsible for any damages, losses or penalties arising in connection therewith or as a result thereof, and (b) indemnify and hold Diodes and its representatives and agents harmless against any and all claims, damages, expenses, and attorney fees arising out of, directly or indirectly, any claim relating to any noncompliance with the applicable laws and regulations, as well as any unintended or unauthorized application.
7. While efforts have been made to ensure the information contained in this document is accurate, complete and current, it may contain technical inaccuracies, omissions and typographical errors. Diodes does not warrant that information contained in this document is error-free and Diodes is under no obligation to update or otherwise correct this information. Notwithstanding the foregoing, Diodes reserves the right to make modifications, enhancements, improvements, corrections or other changes without further notice to this document and any product described herein. This document is written in English but may be translated into multiple languages for reference. Only the English version of this document is the final and determinative format released by Diodes.
8. Any unauthorized copying, modification, distribution, transmission, display or other use of this document (or any portion hereof) is prohibited. Diodes assumes no responsibility for any losses incurred by the customers or users or any third parties arising from any such unauthorized use.

Copyright © 2021 Diodes Incorporated

www.diodes.com

Looking for pricing, stock, or lifecycle information?

Click below to explore more details on WIN SOURCE:

 [View ZXMN20B28KTC on WIN SOURCE](#)

 [Diodes Incorporated](#) Information

Optimize Your Supply Chain with WIN SOURCE Solutions

-  Global Sourcing Solution
-  Obsolete Management
-  Cost Control Management
-  Shortage Management
-  Alternative Solution
-  Excess Inventory Management