



**THE DATASHEET OF  
ZXMN6A25DN8TA**



# ZXMN6A25DN8

## Dual 60V SO8 N-channel enhancement mode MOSFET

### Summary

$V_{(BR)DSS}$	$R_{DS(on)}$ ( $\Omega$ )	$I_D$ (A)
60	0.050 @ $V_{GS} = 10V$	5
	0.070 @ $V_{GS} = 4.5V$	4.2

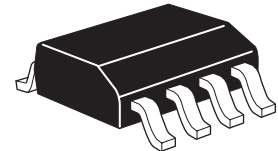

### Description

This new generation trench MOSFET from Zetex features a unique structure combining the benefits of low on-resistance and fast switching, making it ideal for high efficiency power management applications.

### Features

- Low on-resistance
- Fast switching speed
- Low gate drive
- Low profile SO8 package

### Applications

- DC - DC converters
- Power management functions
- Motor control

### Ordering information

Device	Reel (inches)	Tape width (mm)	Quantity per reel
ZXMN6A25DN8TA	7	12	500
ZXMN6A25DN8TC	13	12	2500

### Device marking

ZXMN  
6A25D

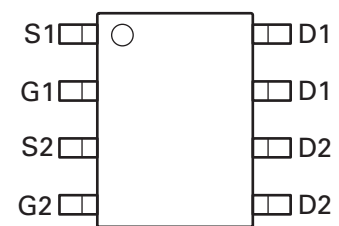
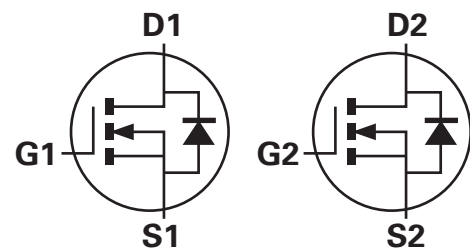

Pin out - top view

# ZXMN6A25DN8

## Absolute maximum ratings

Parameter	Symbol	Limit	Unit
Drain-source voltage	$V_{DSS}$	60	V
Gate-source voltage	$V_{GS}$	$\pm 20$	V
Continuous drain current @ $V_{GS}=10V$ ; $T_{amb}=25^{\circ}C^{(b)}$ (d) @ $V_{GS}=10V$ ; $T_{amb}=70^{\circ}C^{(b)}$ (d) @ $V_{GS}=10V$ ; $T_{amb}=25^{\circ}C^{(a)}$ (d)	$I_D$	5	A
		4	A
		3.8	A
Pulsed drain current <sup>(c)</sup>	$I_{DM}$	24	A
Continuous source current (body diode) <sup>(b)</sup>	$I_S$	3.4	A
Pulsed source current (body diode) <sup>(c)</sup>	$I_{SM}$	24	A
Power dissipation at $T_{amb}=25^{\circ}C^{(a)}$ (d)	$P_D$	1.25	W
Linear derating factor		10	mW/ $^{\circ}C$
Power dissipation at $T_{amb}=25^{\circ}C^{(a)}$ (e)	$P_D$	1.8	W
Linear derating factor		14	mW/ $^{\circ}C$
Power dissipation at $T_{amb}=25^{\circ}C^{(b)}$ (d)	$P_D$	2.1	W
Linear derating factor		17	mW/ $^{\circ}C$
Operating and storage temperature range	$T_j:T_{stg}$	-55 to +150	$^{\circ}C$

## Thermal resistance

Parameter	Symbol	Limit	Unit
Junction to ambient <sup>(a)</sup> (d)	$R_{\theta JA}$	100	$^{\circ}C/W$
Junction to ambient <sup>(a)</sup> (e)	$R_{\theta JA}$	70	$^{\circ}C/W$
Junction to ambient <sup>(b)</sup> (d)	$R_{\theta JA}$	60	$^{\circ}C/W$

### NOTES:

(a) For a device surface mounted on 25mm x 25mm FR4 PCB with high coverage of single sided 1oz copper, in still air conditions.

(b) For a device surface mounted on FR4 PCB measured at  $t \leq 10$  sec.

(c) Repetitive rating 25mm x 25mm FR4 PCB,  $D=0.02$ , pulse width=300 $\mu s$  - pulse width limited by maximum junction temperature.

(d) For a dual device with one active die.

(e) For a device with two active die running at equal power.

# ZXMN6A25DN8

## Typical characteristics

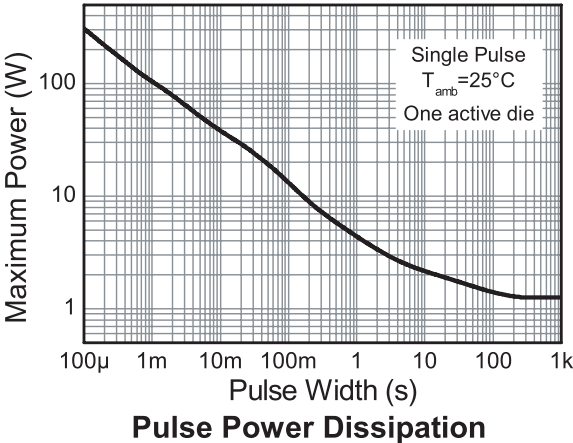
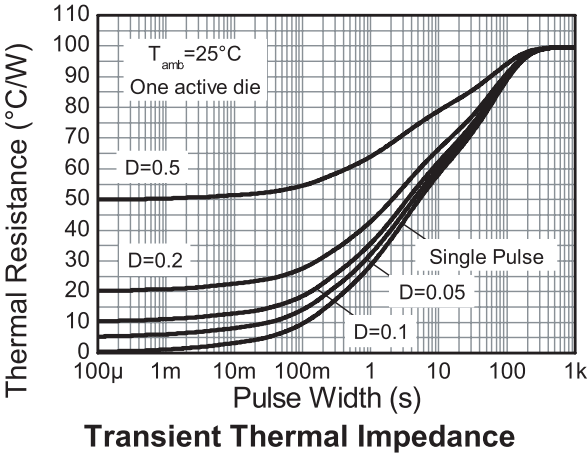
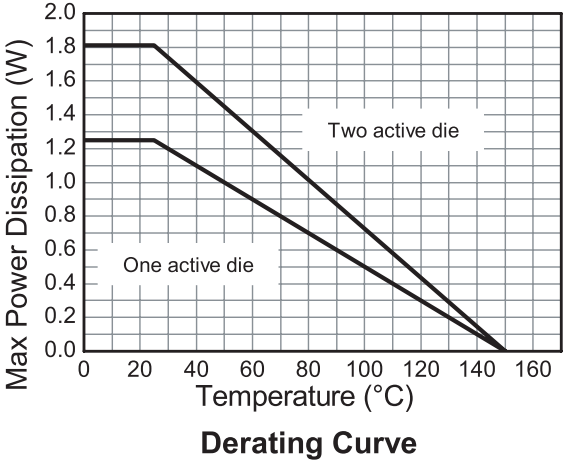
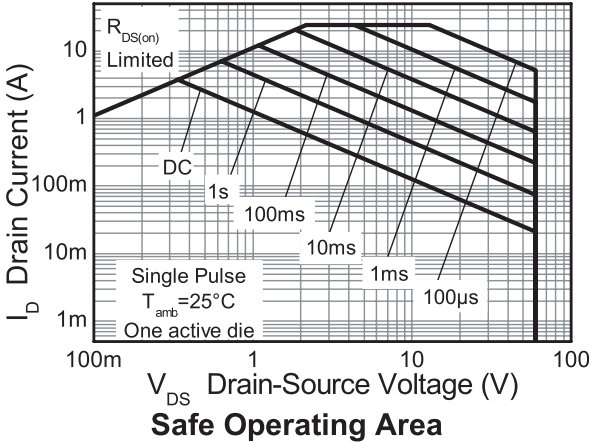

# ZXMN6A25DN8

## Electrical characteristics (at $T_{amb} = 25^{\circ}\text{C}$ unless otherwise stated)

Parameter	Symbol	Min.	Typ.	Max.	Unit	Conditions
<b>Static</b>						
Drain-source breakdown voltage	$V_{(BR)DSS}$	60			V	$I_D=250\mu\text{A}, V_{GS}=0\text{V}$
Zero gate voltage drain current	$I_{DSS}$			1.0	mA	$V_{DS}=60\text{V}, V_{GS}=0\text{V}$
Gate-body leakage	$I_{GSS}$			100	nA	$V_{GS}=\pm 20\text{V}, V_{DS}=0\text{V}$
Gate-source threshold voltage	$V_{GS(th)}$	1.0			V	$I_D=250\mu\text{A}, V_{DS}=V_{GS}$
Static drain-source on-state resistance <sup>(*)</sup>	$R_{DS(on)}$			0.050	$\Omega$	$V_{GS}=10\text{V}, I_D=3.6\text{A}$
				0.070	$\Omega$	$V_{GS}=4.5\text{V}, I_D=3\text{A}$
Forward transconductance <sup>(*)(‡)</sup>	$g_{fs}$		10.2		S	$V_{DS}=15\text{V}, I_D=4.5\text{A}$
<b>Dynamic<sup>(‡)</sup></b>						
Input capacitance	$C_{iss}$		1063		pF	$V_{DS}=30\text{V},$ $V_{GS}=0\text{V}, f=1\text{MHz}$
Output capacitance	$C_{oss}$		104		pF	
Reverse transfer capacitance	$C_{rss}$		64		pF	
<b>Switching<sup>(†)(‡)</sup></b>						
Turn-on delay time	$t_{d(on)}$		3.8		ns	$V_{DD}=30\text{V}, I_D=1\text{A}$ $R_G \cong 6.0\Omega, V_{GS}=10\text{V}$
Rise time	$t_r$		4.0		ns	
Turn-off delay time	$t_{d(off)}$		26.2		ns	
Fall Time	$t_f$		10.6		ns	
Gate charge	$Q_g$		11.0		nC	$V_{DS}=30\text{V}, V_{GS}=5\text{V},$ $I_D=4.5\text{A}$
Total gate charge	$Q_g$		20.4		nC	$V_{DS}=30\text{V}, V_{GS}=10\text{V},$ $I_D=4.5\text{A}$
Gate-source charge	$Q_{gs}$		4.1		nC	
Gate-drain charge	$Q_{gd}$		5.1		nC	
<b>Source-drain diode</b>						
Diode Forward Voltage <sup>(*)</sup>	$V_{SD}$		0.85	0.95	V	$T_J=25^{\circ}\text{C},$ $I_S=5.5\text{A}, V_{GS}=0\text{V}$
Reverse recovery time <sup>(‡)</sup>	$t_{rr}$		22.0		ns	$T_J=25^{\circ}\text{C}, I_F=2.2\text{A},$ $di/dt= 100\text{A}/\mu\text{s}$
Reverse recovery charge <sup>(‡)</sup>	$Q_{rr}$		21.4		nC	

### NOTES:

(\*) Measured under pulsed conditions. Width=300 $\mu\text{s}$ . Duty cycle  $\leq 2\%$ .

(†) Switching characteristics are independent of operating junction temperature.

(‡) For design aid only, not subject to production testing.

# ZXMN6A25DN8

## Typical characteristics

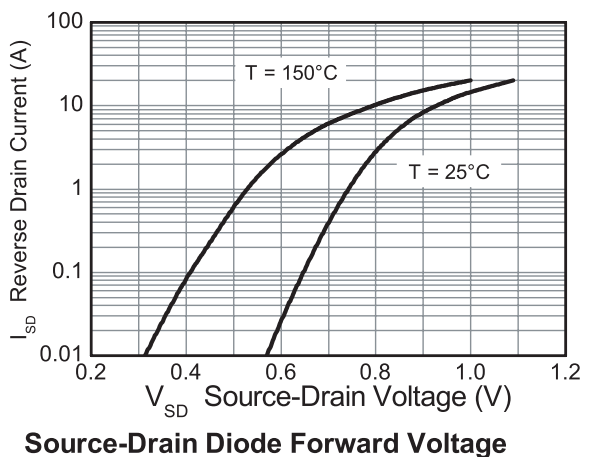
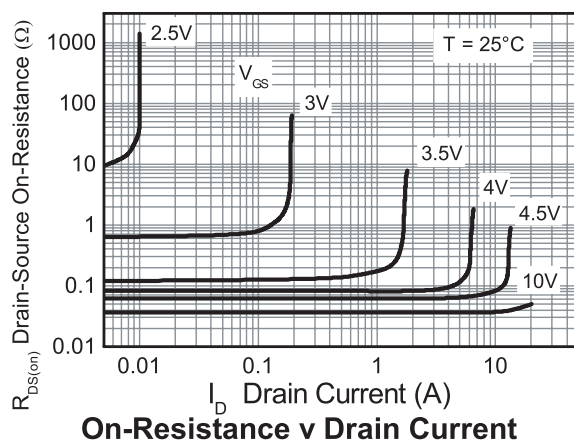
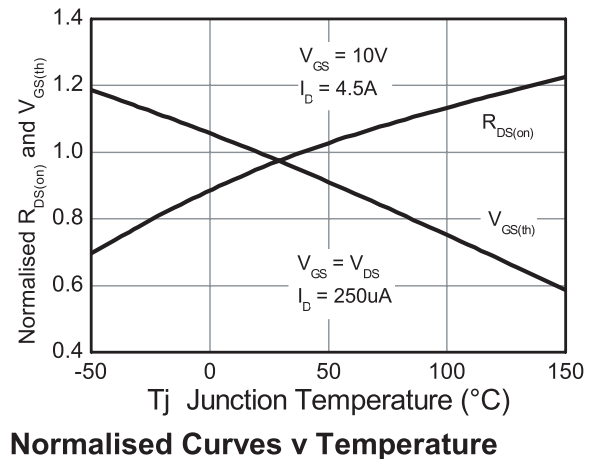
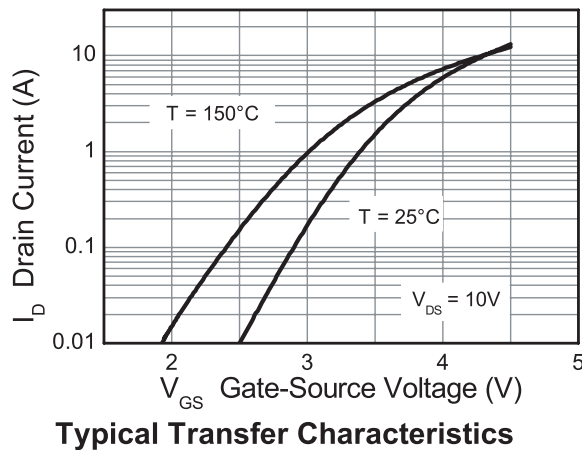
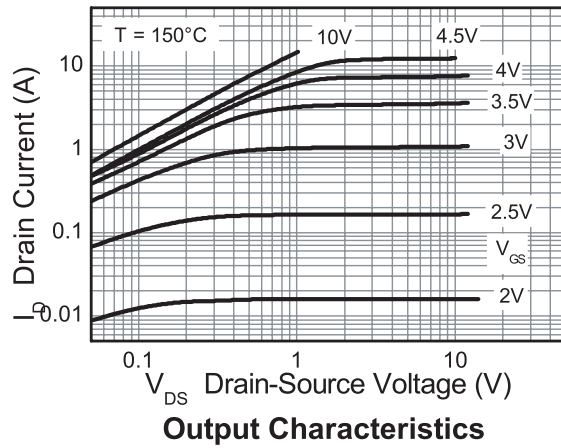
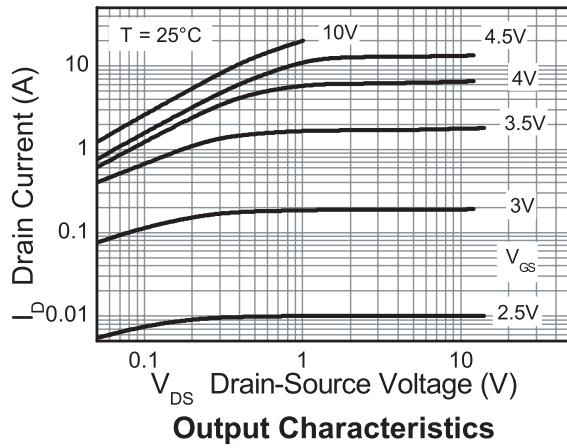

# ZXMN6A25DN8

## Typical characteristics

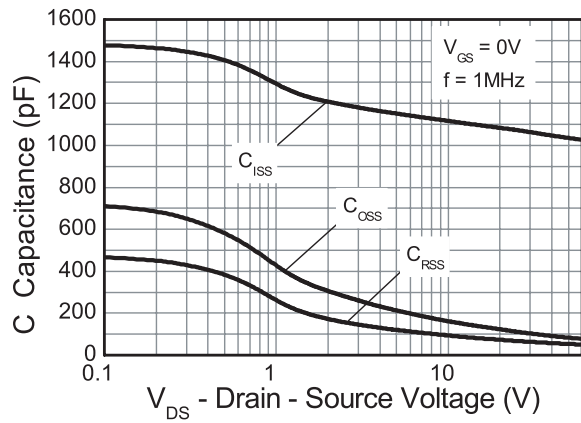

Capacitance v Drain-Source Voltage

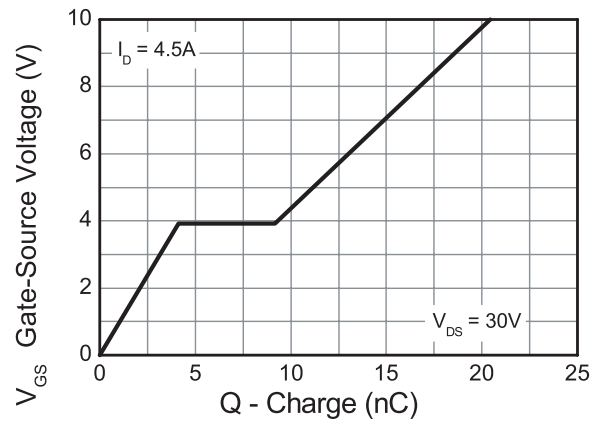

Gate-Source Voltage v Gate Charge

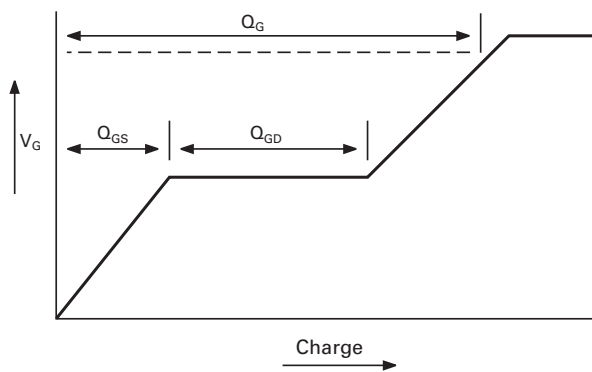

Basic gate charge waveform

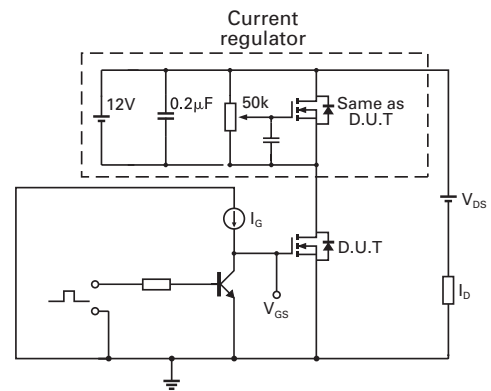

Gate charge test circuit

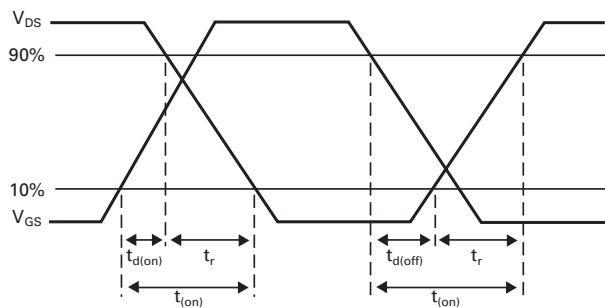

Switching time waveforms

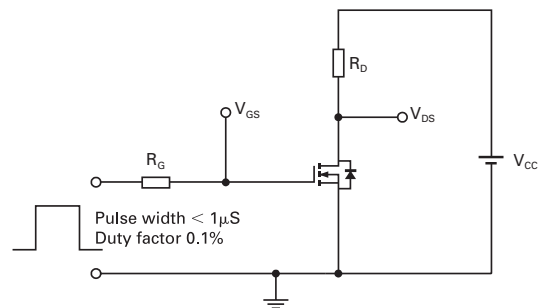

Switching time test circuit

# ZXMN6A25DN8

## Package outline - SO8

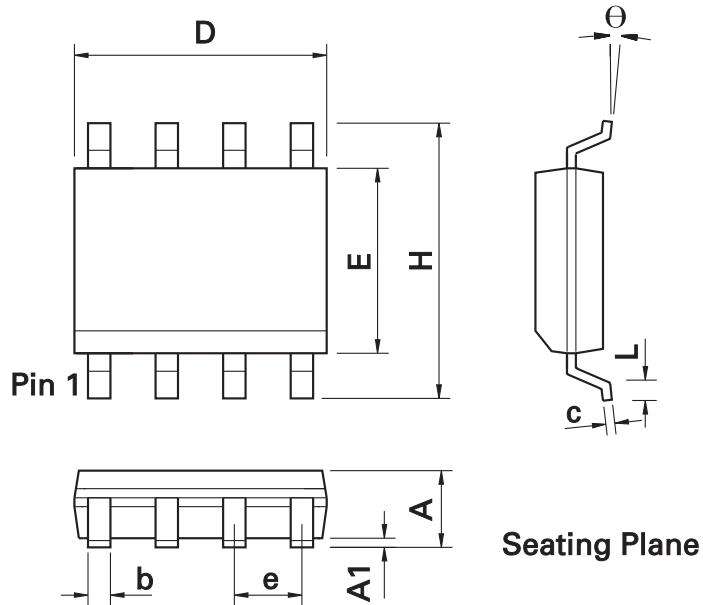

DIM	Inches		Millimeters		DIM	Inches		Millimeters	
	Min.	Max.	Min.	Max.		Min.	Max.	Min.	Max.
A	0.053	0.069	1.35	1.75	e	0.050 BSC		1.27 BSC	
A1	0.004	0.010	0.10	0.25	b	0.013	0.020	0.33	0.51
D	0.189	0.197	4.80	5.00	c	0.008	0.010	0.19	0.25
H	0.228	0.244	5.80	6.20	Θ	0°	8°	0°	8°
E	0.150	0.157	3.80	4.00	h	0.010	0.020	0.25	0.50
L	0.016	0.050	0.40	1.27	-	-	-	-	-

**Note:** Controlling dimensions are in inches. Approximate dimensions are provided in millimeters

# ZXMN6A25DN8

---

## Definitions

### Product change

Zetex Semiconductors reserves the right to alter, without notice, specifications, design, price or conditions of supply of any product or service. Customers are solely responsible for obtaining the latest relevant information before placing orders.

### Applications disclaimer

The circuits in this design/application note are offered as design ideas. It is the responsibility of the user to ensure that the circuit is fit for the user's application and meets with the user's requirements. No representation or warranty is given and no liability whatsoever is assumed by Zetex with respect to the accuracy or use of such information, or infringement of patents or other intellectual property rights arising from such use or otherwise. Zetex does not assume any legal responsibility or will not be held legally liable (whether in contract, tort (including negligence), breach of statutory duty, restriction or otherwise) for any damages, loss of profit, business, contract, opportunity or consequential loss in the use of these circuit applications, under any circumstances.

### Life support

Zetex products are specifically not authorized for use as critical components in life support devices or systems without the express written approval of the Chief Executive Officer of Zetex Semiconductors plc. As used herein:

A. Life support devices or systems are devices or systems which:

1. are intended to implant into the body

or

2. support or sustain life and whose failure to perform when properly used in accordance with instructions for use provided in the labeling can be reasonably expected to result in significant injury to the user.

B. A critical component is any component in a life support device or system whose failure to perform can be reasonably expected to cause the failure of the life support device or to affect its safety or effectiveness.

### Reproduction

The product specifications contained in this publication are issued to provide outline information only which (unless agreed by the company in writing) may not be used, applied or reproduced for any purpose or form part of any order or contract or be regarded as a representation relating to the products or services concerned.

### Terms and Conditions

All products are sold subjects to Zetex' terms and conditions of sale, and this disclaimer (save in the event of a conflict between the two when the terms of the contract shall prevail) according to region, supplied at the time of order acknowledgement.

For the latest information on technology, delivery terms and conditions and prices, please contact your nearest Zetex sales office.

### Quality of product

Zetex is an ISO 9001 and TS16949 certified semiconductor manufacturer.

To ensure quality of service and products we strongly advise the purchase of parts directly from Zetex Semiconductors or one of our regionally authorized distributors. For a complete listing of authorized distributors please visit: [www.zetex.com/salesnetwork](http://www.zetex.com/salesnetwork)

Zetex Semiconductors does not warrant or accept any liability whatsoever in respect of any parts purchased through unauthorized sales channels.

### ESD (Electrostatic discharge)

Semiconductor devices are susceptible to damage by ESD. Suitable precautions should be taken when handling and transporting devices. The possible damage to devices depends on the circumstances of the handling and transporting, and the nature of the device. The extent of damage can vary from immediate functional or parametric malfunction to degradation of function or performance in use over time. Devices suspected of being affected should be replaced.

### Green compliance

Zetex Semiconductors is committed to environmental excellence in all aspects of its operations which includes meeting or exceeding regulatory requirements with respect to the use of hazardous substances. Numerous successful programs have been implemented to reduce the use of hazardous substances and/or emissions.

All Zetex components are compliant with the RoHS directive, and through this it is supporting its customers in their compliance with WEEE and ELV directives.

### Product status key:

"Preview"	Future device intended for production at some point. Samples may be available
"Active"	Product status recommended for new designs
"Last time buy (LTB)"	Device will be discontinued and last time buy period and delivery is in effect
"Not recommended for new designs"	Device is still in production to support existing designs and production
"Obsolete"	Production has been discontinued

### Datasheet status key:

"Draft version"	This term denotes a very early datasheet version and contains highly provisional information, which may change in any manner without notice.
"Provisional version"	This term denotes a pre-release datasheet. It provides a clear indication of anticipated performance. However, changes to the test conditions and specifications may occur, at any time and without notice.
"Issue"	This term denotes an issued datasheet containing finalized specifications. However, changes to specifications may occur, at any time and without notice.



### Zetex sales offices

Europe	Americas	Asia Pacific	Corporate Headquarters
Zetex GmbH Kustermann-park Balanstraße 59 D-81541 München Germany Telephone: (49) 89 45 49 49 0 Fax: (49) 89 45 49 49 49 europe.sales@zetex.com	Zetex Inc 700 Veterans Memorial Highway Hauppauge, NY 11788 USA Telephone: (1) 631 360 2222 Fax: (1) 631 360 8222 usa.sales@zetex.com	Zetex (Asia Ltd) 3701-04 Metroplaza Tower 1 Hing Fong Road, Kwai Fong Hong Kong Telephone: (852) 26100 611 Fax: (852) 24250 494 asia.sales@zetex.com	Zetex Semiconductors plc Zetex Technology Park, Chadderton Oldham, OL9 9LL United Kingdom Telephone: (44) 161 622 4444 Fax: (44) 161 622 4446 hq@zetex.com

© 2006 Published by Zetex Semiconductors plc

## Looking for pricing, stock, or lifecycle information?

Click below to explore more details on WIN SOURCE:

-  [View ZXMN6A25DN8TA on WIN SOURCE](#)
-  [Diodes Incorporated Information](#)

## Optimize Your Supply Chain with WIN SOURCE Solutions

-  Global Sourcing Solution
-  Obsolete Management
-  Cost Control Management
-  Shortage Management
-  Alternative Solution
-  Excess Inventory Management