



**THE DATASHEET OF  
ZXTC2062E6TA**



**20V COMPLEMENTARY MEDIUM POWER TRANSISTORS IN SOT26**

**Features**

- NPN + PNP Combination
- $BV_{CEO} > 20$  (-20)V
- $BV_{EBO} > 7$  (-7)V
- Continuous Collector Current  $I_C = 4$  (-3.5)A
- $V_{CE(sat)} < 50$  (-65)mV @ 1A
- $R_{CE(sat)} = 35$  (54)m $\Omega$
- **Totally Lead-Free & Fully RoHS Compliant (Notes 1 & 2)**
- **Halogen and Antimony Free. "Green" Device (Note 3)**
- **Qualified to AEC-Q101 Standards for High Reliability**

**Mechanical Data**

- Case: SOT26
- Case Material: Molded Plastic, "Green" Molding Compound
- UL Flammability Classification Rating 94V-0
- Moisture Sensitivity: Level 1 per J-STD-020
- Terminals: Finish – Matte Tin Plated Leads, Solderable per MIL-STD-202, Method 208 (E3)
- Weight: 0.015 grams (Approximate)

**Applications**

- MOSFET and IGBT Gate Driving
- Motor Drive

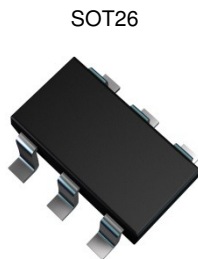

Top View

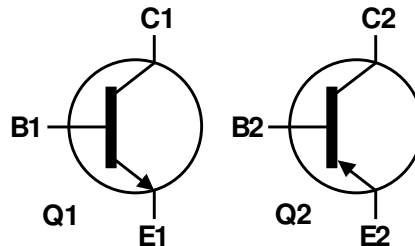

Device Symbol

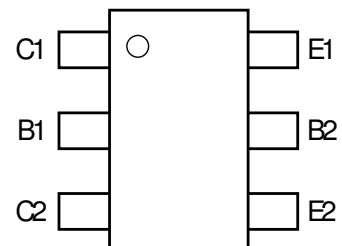

Top View Pin-Out

**Ordering Information** (Note 4)

Product	Marking	Reel size (inches)	Tape width (mm)	Quantity per reel
ZXTC2062E6TA	2062	7	8	3,000

- Notes:
1. No purposely added lead. Fully EU Directive 2002/95/EC (RoHS) & 2011/65/EU (RoHS 2) compliant.
  2. See <http://www.diodes.com/> for more information about Diodes Incorporated's definitions of Halogen and Antimony free, "Green" and Lead-Free.
  3. Halogen and Antimony free "Green" products are defined as those which contain <900ppm bromine, <900ppm chlorine (<1500ppm total Br + Cl) and <1000ppm antimony compounds.
  4. For packaging details, go to our website at <http://www.diodes.com>.

**Marking Information**

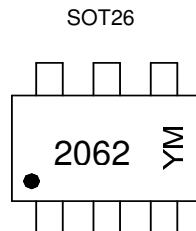

2062 = Product Type Marking Code  
 YM = Date Code Marking  
 Y or  $\bar{Y}$  = Year (ex: C = 2015)  
 M or  $\bar{M}$  = Month (ex: 9 = September)

Date Code Key

Year	2015	2016	2017	2018	2019	2020	2021	2022	2023	2024	2025
Code	C	D	E	F	G	H	I	J	K	L	M

Month	Jan	Feb	Mar	Apr	May	Jun	Jul	Aug	Sep	Oct	Nov	Dec
Code	1	2	3	4	5	6	7	8	9	O	N	D

**Absolute Maximum Ratings – Q1 (NPN Transistor)** (@T<sub>A</sub> = +25°C, unless otherwise specified.)

Characteristic	Symbol	Value	Unit
Collector-Base Voltage	V <sub>CBO</sub>	100	V
Collector-Emitter Voltage	V <sub>CEO</sub>	20	V
Emitter-Collector Voltage (reverse blocking)	V <sub>ECO</sub>	5	V
Emitter-Base Voltage	V <sub>EBO</sub>	7	V
Continuous Collector Current	I <sub>C</sub>	4	A
Peak Pulsed Collector Current	I <sub>CM</sub>	10	A
Base Current	I <sub>B</sub>	1	A

**Absolute Maximum Ratings – Q2 (PNP Transistor)** (@T<sub>A</sub> = +25°C, unless otherwise specified.)

Characteristic	Symbol	Value	Unit
Collector-Base Voltage	V <sub>CBO</sub>	-25	V
Collector-Emitter Voltage	V <sub>CEO</sub>	-20	V
Emitter-Collector Voltage (reverse blocking)	V <sub>ECO</sub>	-4	V
Emitter-Base Voltage	V <sub>EBO</sub>	-7	V
Continuous Collector Current	I <sub>C</sub>	-3.5	A
Peak Pulsed Collector Current	I <sub>CM</sub>	-10	A
Base Current	I <sub>B</sub>	-1	A

**Thermal Characteristics** (@T<sub>A</sub> = +25°C, unless otherwise specified.)

Characteristic	Symbol	Value	Unit
Power Dissipation Linear Derating Factor	P <sub>D</sub>	(Notes 5 & 9)	0.7
		(Notes 6 & 9)	5.6
		(Notes 6 & 10)	0.9
		(Notes 7 & 9)	7.2
		(Notes 8 & 9)	1.1
		(Notes 8 & 9)	8.8
Thermal Resistance, Junction to Ambient	R <sub>θJA</sub>	(Notes 5 & 9)	1.1
		(Notes 6 & 9)	8.8
		(Notes 6 & 10)	1.7
		(Notes 7 & 9)	13.6
		(Notes 8 & 9)	179
Thermal Resistance, Junction to Lead	R <sub>θJL</sub>	87.5	°C/W
Operating and Storage Temperature Range	T <sub>J</sub> , T <sub>STG</sub>	-55 to +150	°C

**ESD Ratings** (Note 12)

Characteristic	Symbol	Value	Unit	JEDEC Class
Electrostatic Discharge - Human Body Model	ESD HBM	4,000	V	3A
Electrostatic Discharge - Machine Model	ESD MM	400	V	C

- Notes:
- For a device surface mounted on 15mm x 15mm FR4 PCB with high coverage of single sided 1oz copper, in still air conditions; the device is measured when operating in a steady-state condition.
  - Same as Note (5), except the device is surface mounted on 25mm x 25mm 1oz copper.
  - Same as Note (5), except the device is surface mounted on 50mm x 50mm 2oz copper.
  - Same as Note (7), except the device is measured at t < 5 seconds.
  - For device with one active die, both collectors attached to a common heatsink.
  - For device with two active dice running at equal power, split heatsink 50% to each collector.
  - Thermal resistance from junction to solder-point (at the end of the collector lead).
  - Refer to JEDEC specification JESD22-A114 and JESD22-A115.

**Thermal Characteristics and Derating Information**

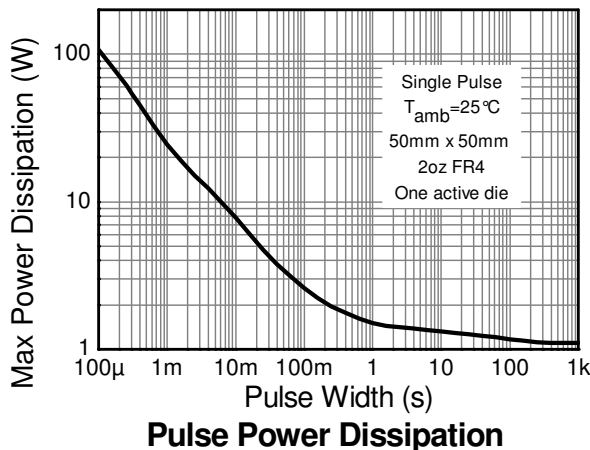
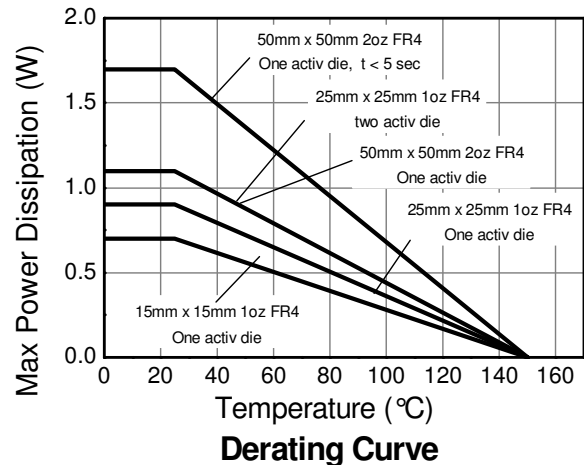
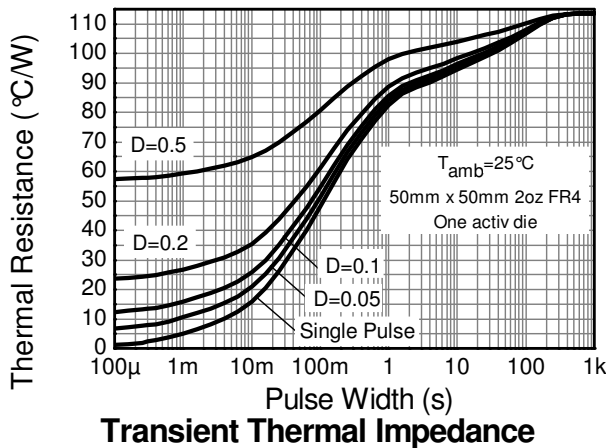
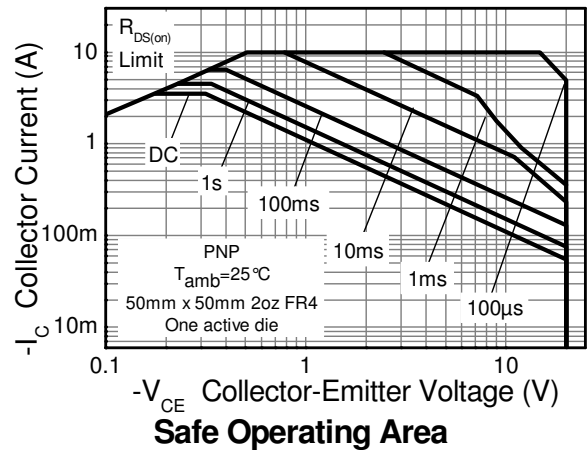
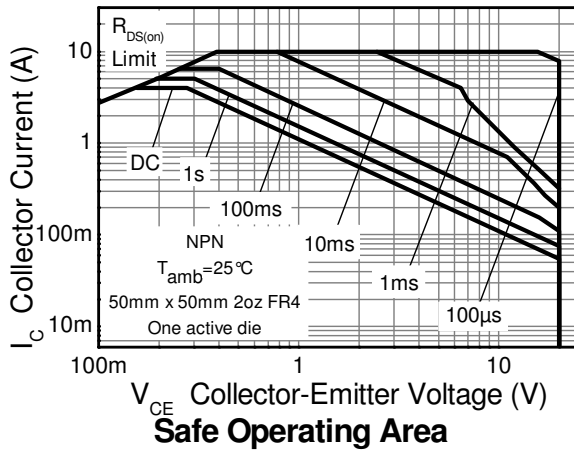

**Electrical Characteristics – Q1 (NPN Transistor)** (@ $T_A = +25^\circ\text{C}$ , unless otherwise specified.)

Characteristic	Symbol	Min	Typ	Max	Unit	Test Condition
<b>OFF CHARACTERISTICS</b>						
Collector-Base Breakdown Voltage	$BV_{CBO}$	100	140	—	V	$I_C = 100\mu\text{A}$ , $I_E = 0$
Collector-Emitter Breakdown Voltage (Note 13)	$BV_{CEO}$	20	35	—	V	$I_C = 10\text{mA}$ , $I_B = 0$
Emitter-Base Breakdown Voltage	$BV_{EBO}$	7	8.3	—	V	$I_E = 100\mu\text{A}$ , $I_C = 0$
Emitter-Collector breakdown voltage (base open)	$BV_{ECO}$	5	6	—	V	$I_E = 100\mu\text{A}$
Collector Cutoff Current	$I_{CBO}$	—	<1	50	nA	$V_{CB} = 100\text{V}$
Collector Cutoff Current	$I_{EBO}$	—	<1	50	nA	$V_{CB} = 100\text{V}$ , $T_A = +100^\circ\text{C}$
Collector Cutoff Current	$I_{EBO}$	—	<1	50	nA	$V_{EB} = 5.6\text{V}$
<b>ON CHARACTERISTICS (Note 13)</b>						
DC Current Gain	$h_{FE}$	300 280 140 —	450 420 210 15	900 — — —	—	$I_C = 10\text{mA}$ , $V_{CE} = 2\text{V}$ $I_C = 1\text{A}$ , $V_{CE} = 2\text{V}$ $I_C = 4\text{A}$ , $V_{CE} = 2\text{V}$ $I_C = 15\text{A}$ , $V_{CE} = 2\text{V}$
Collector-Emitter Saturation Voltage	$V_{CE(sat)}$	—	40 60 95 140	50 75 115 190	mV	$I_C = 1.0\text{A}$ , $I_B = 100\text{mA}$ $I_C = 1.0\text{A}$ , $I_B = 20\text{mA}$ $I_C = 2.0\text{A}$ , $I_B = 40\text{mA}$ $I_C = 4\text{A}$ , $I_B = 200\text{mA}$
Base-Emitter Saturation Voltage	$V_{BE(sat)}$	—	940	1,050	mV	$I_C = 4\text{A}$ , $I_B = 200\text{mA}$
Base-Emitter Turn-On Voltage	$V_{BE(on)}$	—	810	900	mV	$I_C = 4\text{A}$ , $V_{CE} = 2\text{V}$
<b>SMALL SIGNAL CHARACTERISTICS</b>						
Output Capacitance	$C_{obo}$	—	17	25	pF	$V_{CB} = 10\text{V}$ , $f = 1.0\text{MHz}$
Current Gain-Bandwidth Product	$f_T$	—	215	—	MHz	$V_{CE} = 10\text{V}$ , $I_C = 50\text{mA}$ , $f = 100\text{MHz}$
Delay Time	$t_d$	—	68	—	ns	$V_{CC} = 10\text{V}$ , $I_C = 1\text{A}$ , $I_{B1} = -I_{B2} = 10\text{mA}$
Rise Time	$t_r$	—	72	—	ns	
Storage Time	$t_s$	—	361	—	ns	
Fall Time	$t_f$	—	64	—	ns	

Notes: 13. Measured under pulsed conditions. Pulse width  $\leq 300\mu\text{s}$ . Duty cycle  $\leq 2\%$ .

**Electrical Characteristics – Q2 (PNP Transistor)** (@T<sub>A</sub> = +25°C, unless otherwise specified.)

Characteristic	Symbol	Min	Typ	Max	Unit	Test Condition
<b>OFF CHARACTERISTICS</b>						
Collector-Base Breakdown Voltage	BV <sub>CBO</sub>	-25	-55	—	V	I <sub>C</sub> = -100μA, I <sub>E</sub> = 0
Collector-Emitter Breakdown Voltage (Note 13)	BV <sub>CEO</sub>	-20	-45	—	V	I <sub>C</sub> = -10mA, I <sub>B</sub> = 0
Emitter-Base Breakdown Voltage	BV <sub>EBO</sub>	-7	-8.3	—	V	I <sub>E</sub> = -100μA, I <sub>C</sub> = 0
Collector Cutoff Current	I <sub>CBO</sub>	—	< -1	-50	nA	V <sub>CB</sub> = -25V
Collector Cutoff Current	I <sub>EBO</sub>	—	< -1	-50	nA	V <sub>CB</sub> = -25V, T <sub>A</sub> = +100°C
Collector Cutoff Current	I <sub>EBO</sub>	—	< -1	-50	nA	V <sub>EB</sub> = -5.6V
<b>ON CHARACTERISTICS (Note 13)</b>						
DC Current Gain	h <sub>FE</sub>	300 170 65 —	450 300 100 15	900 — — —	—	I <sub>C</sub> = -10mA, V <sub>CE</sub> = -2V I <sub>C</sub> = -1.0A, V <sub>CE</sub> = -2V I <sub>C</sub> = -3.5A, V <sub>CE</sub> = -2V I <sub>C</sub> = -10A, V <sub>CE</sub> = -2V
Collector-Emitter Saturation Voltage	V <sub>CE(sat)</sub>	— — —	-55 -100 -185 -190	-65 -135 -280 -250	mV	I <sub>C</sub> = -1.0A, I <sub>B</sub> = -100mA I <sub>C</sub> = -1.0A, I <sub>B</sub> = -20mA I <sub>C</sub> = -2.0A, I <sub>B</sub> = -40mA I <sub>C</sub> = -3.5A, I <sub>B</sub> = -175mA
Base-Emitter Saturation Voltage	V <sub>BE(sat)</sub>	—	-925	-1,000	mV	I <sub>C</sub> = -3.5A, I <sub>B</sub> = -175mA
Base-Emitter Turn-On Voltage	V <sub>BE(on)</sub>	—	-835	-900	mV	I <sub>C</sub> = -3.5A, V <sub>CE</sub> = -2V
<b>SMALL SIGNAL CHARACTERISTICS</b>						
Output Capacitance	C <sub>obo</sub>	—	21	30	pF	V <sub>CB</sub> = -10V, f = 1.0MHz
Current Gain-Bandwidth Product	f <sub>T</sub>	—	290	—	MHz	V <sub>CE</sub> = -10V, I <sub>C</sub> = -50mA, f = 100MHz
Delay Time	t <sub>d</sub>	—	56	—	ns	V <sub>CC</sub> = -10V, I <sub>C</sub> = -1A, I <sub>B1</sub> = -I <sub>B2</sub> = -10mA
Rise Time	t <sub>r</sub>	—	68	—	ns	
Storage Time	t <sub>s</sub>	—	158	—	ns	
Fall Time	t <sub>f</sub>	—	59	—	ns	

Note: 13. Measured under pulsed conditions. Pulse width ≤ 300μs. Duty cycle ≤ 2%.

**Typical Electrical Characteristics – Q1 (NPN Transistor)** (@ $T_A = +25^\circ\text{C}$ , unless otherwise specified.)

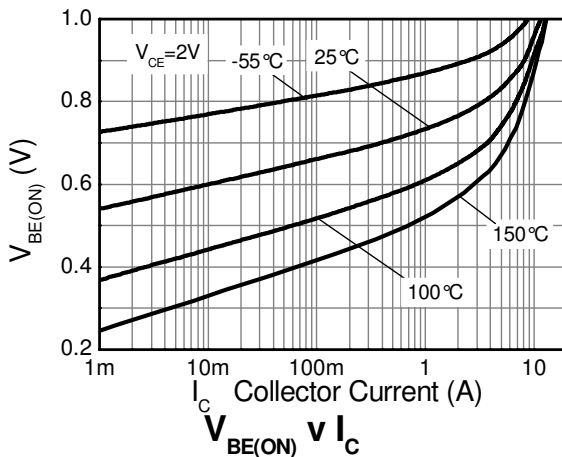
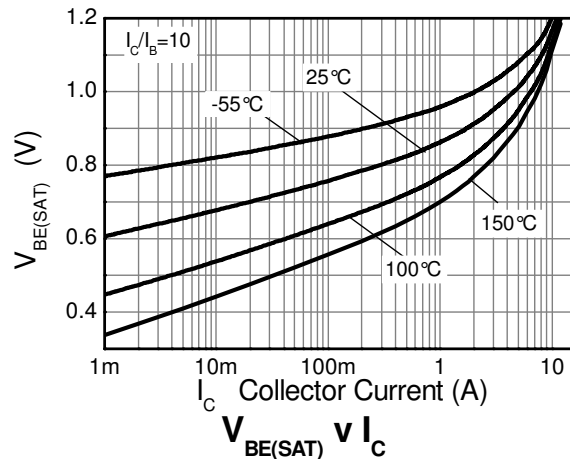
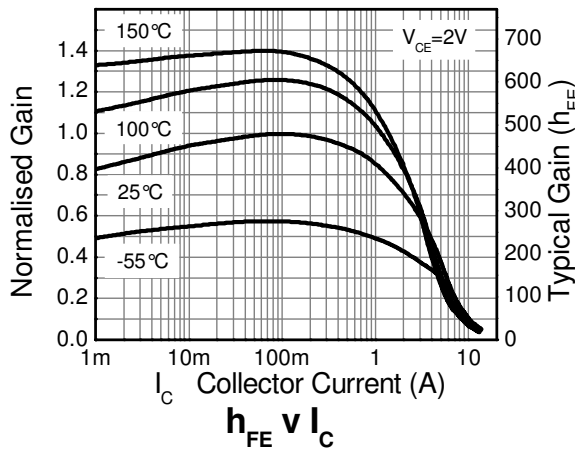
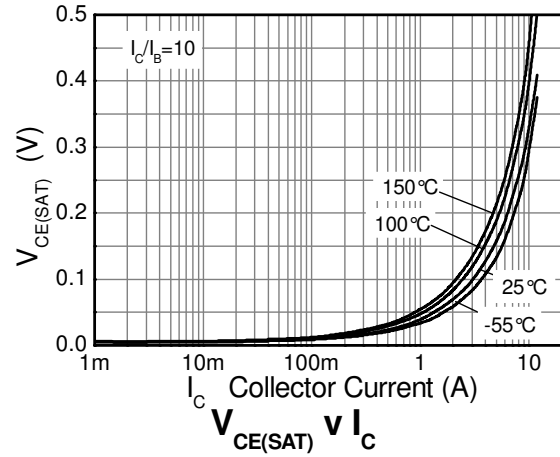
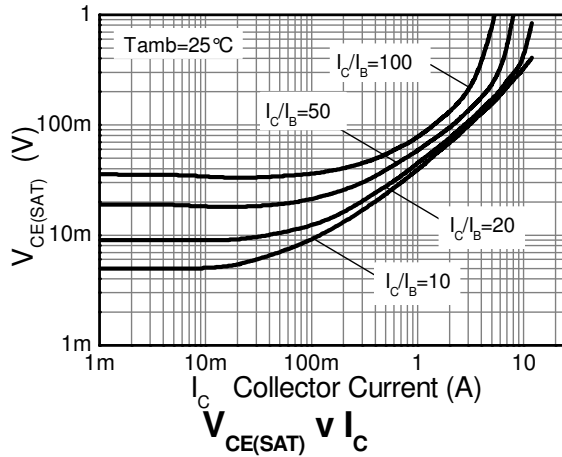

**Typical Electrical Characteristics – Q2 (PNP Transistor)** (@T<sub>A</sub> = +25°C, unless otherwise specified.)

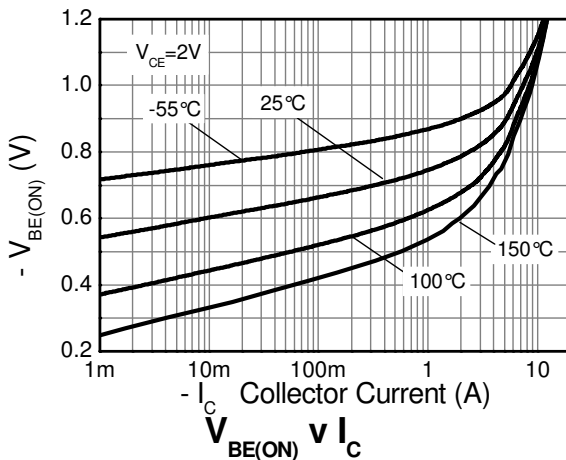
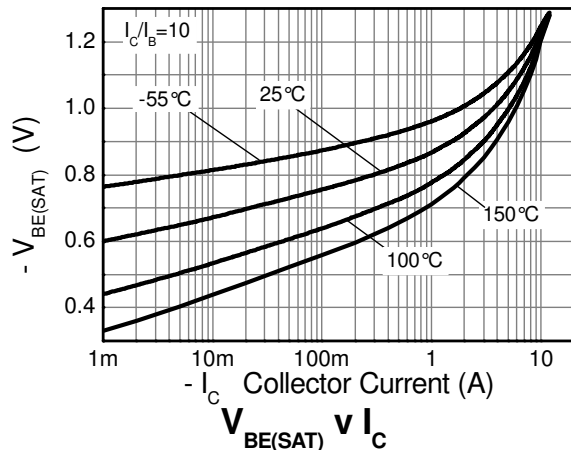
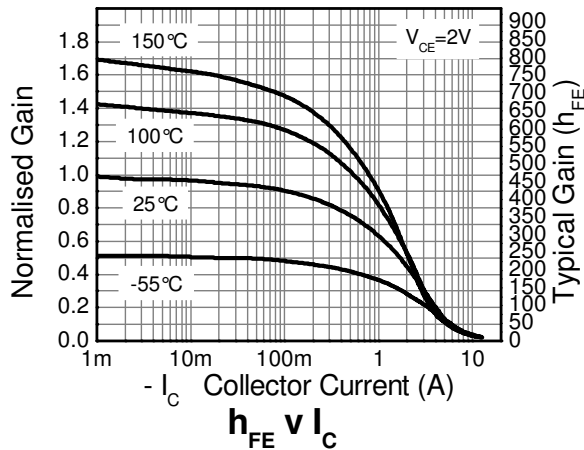
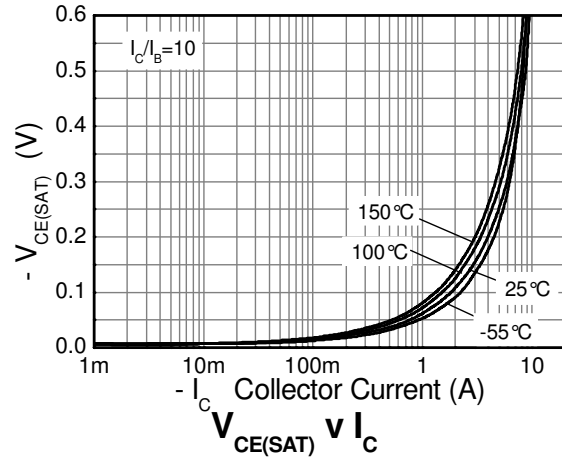
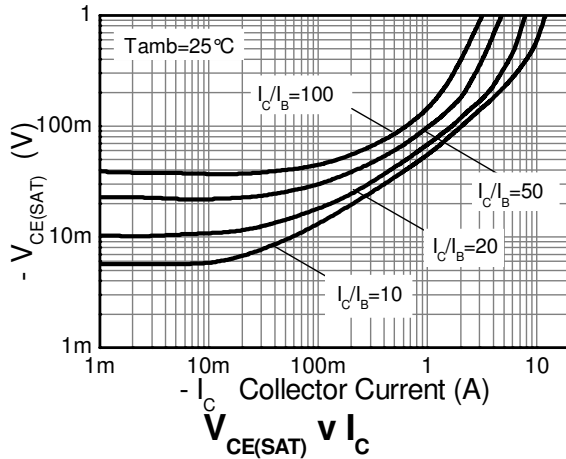

**Package Outline Dimensions**

Please see AP02002 at <http://www.diodes.com/datasheets/ap02002.pdf> for the latest version.

SOT26

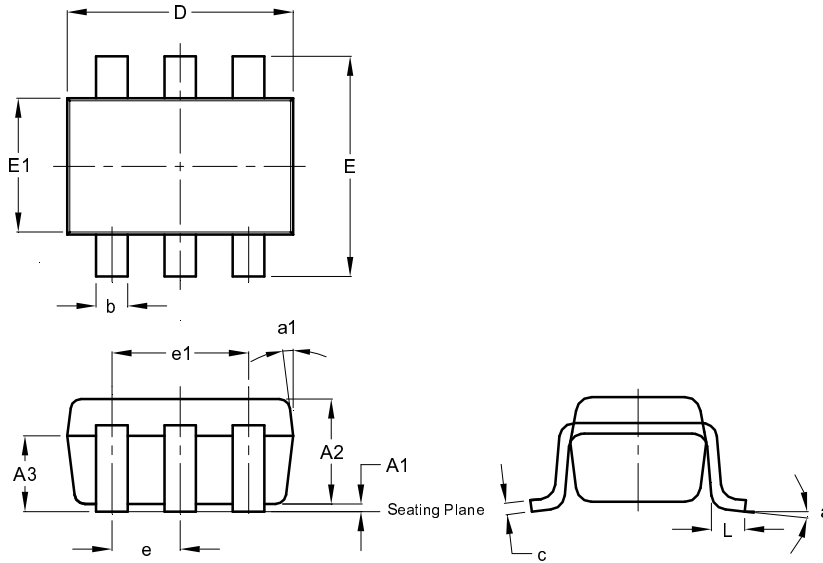

SOT26			
Dim	Min	Max	Typ
A1	0.013	0.10	0.05
A2	1.00	1.30	1.10
A3	0.70	0.80	0.75
b	0.35	0.50	0.38
c	0.10	0.20	0.15
D	2.90	3.10	3.00
e	-	-	0.95
e1	-	-	1.90
E	2.70	3.00	2.80
E1	1.50	1.70	1.60
L	0.35	0.55	0.40
a	-	-	8°
a1	-	-	7°
All Dimensions in mm			

**Suggested Pad Layout**

Please see AP02001 at <http://www.diodes.com/datasheets/ap02001.pdf> for the latest version.

SOT26

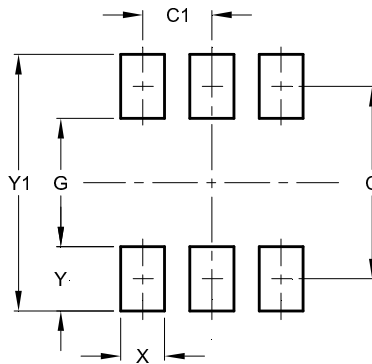

Dimensions	Value (in mm)
C	2.40
C1	0.95
G	1.60
X	0.55
Y	0.80
Y1	3.20

**IMPORTANT NOTICE**

DIODES INCORPORATED MAKES NO WARRANTY OF ANY KIND, EXPRESS OR IMPLIED, WITH REGARDS TO THIS DOCUMENT, INCLUDING, BUT NOT LIMITED TO, THE IMPLIED WARRANTIES OF MERCHANTABILITY AND FITNESS FOR A PARTICULAR PURPOSE (AND THEIR EQUIVALENTS UNDER THE LAWS OF ANY JURISDICTION).

Diodes Incorporated and its subsidiaries reserve the right to make modifications, enhancements, improvements, corrections or other changes without further notice to this document and any product described herein. Diodes Incorporated does not assume any liability arising out of the application or use of this document or any product described herein; neither does Diodes Incorporated convey any license under its patent or trademark rights, nor the rights of others. Any Customer or user of this document or products described herein in such applications shall assume all risks of such use and will agree to hold Diodes Incorporated and all the companies whose products are represented on Diodes Incorporated website, harmless against all damages.

Diodes Incorporated does not warrant or accept any liability whatsoever in respect of any products purchased through unauthorized sales channel. Should Customers purchase or use Diodes Incorporated products for any unintended or unauthorized application, Customers shall indemnify and hold Diodes Incorporated and its representatives harmless against all claims, damages, expenses, and attorney fees arising out of, directly or indirectly, any claim of personal injury or death associated with such unintended or unauthorized application.

Products described herein may be covered by one or more United States, international or foreign patents pending. Product names and markings noted herein may also be covered by one or more United States, international or foreign trademarks.

This document is written in English but may be translated into multiple languages for reference. Only the English version of this document is the final and determinative format released by Diodes Incorporated.

**LIFE SUPPORT**

Diodes Incorporated products are specifically not authorized for use as critical components in life support devices or systems without the express written approval of the Chief Executive Officer of Diodes Incorporated. As used herein:

A. Life support devices or systems are devices or systems which:

1. are intended to implant into the body, or
2. support or sustain life and whose failure to perform when properly used in accordance with instructions for use provided in the labeling can be reasonably expected to result in significant injury to the user.

B. A critical component is any component in a life support device or system whose failure to perform can be reasonably expected to cause the failure of the life support device or to affect its safety or effectiveness.

Customers represent that they have all necessary expertise in the safety and regulatory ramifications of their life support devices or systems, and acknowledge and agree that they are solely responsible for all legal, regulatory and safety-related requirements concerning their products and any use of Diodes Incorporated products in such safety-critical, life support devices or systems, notwithstanding any devices- or systems-related information or support that may be provided by Diodes Incorporated. Further, Customers must fully indemnify Diodes Incorporated and its representatives against any damages arising out of the use of Diodes Incorporated products in such safety-critical, life support devices or systems.

Copyright © 2015, Diodes Incorporated

[www.diodes.com](http://www.diodes.com)

## Looking for pricing, stock, or lifecycle information?

Click below to explore more details on WIN SOURCE:

 [View ZXTC2062E6TA on WIN SOURCE](#)

 [Diodes Incorporated Information](#)

## Optimize Your Supply Chain with WIN SOURCE Solutions

-  Global Sourcing Solution
-  Obsolete Management
-  Cost Control Management
-  Shortage Management
-  Alternative Solution
-  Excess Inventory Management