



**THE DATASHEET OF  
ZXTN619MATA**



## Features

- $BV_{CEO} > 50V$
- $I_C = 4A$  Continuous Collector Current
- Low Saturation Voltage (100mV max @1A)
- $R_{SAT} = 68m\Omega$  for a Low Equivalent On-Resistance
- $h_{FE}$  Specified up to 6A for High Current Gain Hold Up
- Low Profile 0.6mm High Package for Thin Applications
- $R_{\theta JA}$  Efficient, 60% Lower than SOT23
- 4mm<sup>2</sup> Footprint, 50% Smaller than SOT23
- **Totally Lead-Free & Fully RoHS Compliant (Notes 1 & 2)**
- **Halogen and Antimony Free. "Green" Device (Note 3)**
- **For automotive applications requiring specific change control (i.e.: parts qualified to AEC-Q100/101/104/200, PPAP capable, and manufactured in IATF 16949 certified facilities), please refer to the related automotive grade (Q-suffix) part. A listing can be found at <https://www.diodes.com/products/automotive/automotive-products/>.**
- **This part is qualified to JEDEC standards (as references in AEC-Q) for High Reliability. <https://www.diodes.com/quality/product-definitions/>**

## Mechanical Data

- Package: U-DFN2020-3
- Nominal Package Height: 0.6mm
- Package Material: Molded Plastic. "Green" Molding Compound. UL Flammability Rating 94V-0
- Moisture Sensitivity: Level 1 per J-STD-020
- Terminals: Finish – NiPdAu, Solderable per MIL-STD-202, Method 208
- Weight: 0.01 grams (Approximate)

## Applications

- MOSFET gate driving
- DC-DC converters
- Charging circuits
- Motor controls
- Power switches

U-DFN2020-3 (Type B)



Top View

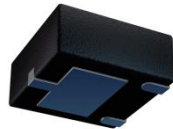

Bottom View

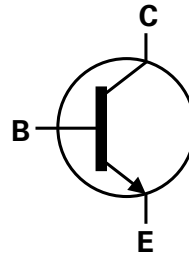

Device Symbol

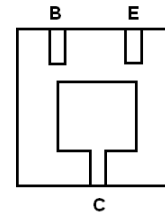

Bottom View  
Pin-Out

## Ordering Information (Note 4)

Part Number	Package	Marking	Reel Size (inches)	Tape Width (mm)	Packing	
					Qty.	Carrier
ZXTN619MATA	U-DFN2020-3 (Type B)	SC	7	8	3,000	Reel

- Notes:
1. No purposely added lead. Fully EU Directive 2002/95/EC (RoHS), 2011/65/EU (RoHS 2) & 2015/863/EU (RoHS 3) compliant.
  2. See <https://www.diodes.com/quality/lead-free/> for more information about Diodes Incorporated's definitions of Halogen- and Antimony-free, "Green" and Lead-free.
  3. Halogen- and Antimony-free "Green" products are defined as those which contain <900ppm bromine, <900ppm chlorine (<1500ppm total Br + Cl) and <1000ppm antimony compounds.
  4. For packaging details, go to our website at <https://www.diodes.com/design/support/packaging/diodes-packaging/>.

## Marking Information

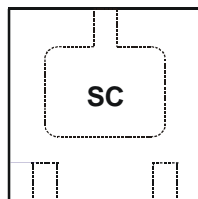

Top View

SC = Product Type Marking code

**Absolute Maximum Ratings** (@T<sub>A</sub> = +25°C, unless otherwise specified.)

Characteristic	Symbol	Value	Unit
Collector-Base Voltage	V <sub>CB0</sub>	100	V
Collector-Emitter Voltage	V <sub>CEO</sub>	50	
Emitter-Base Voltage	V <sub>EBO</sub>	7	
Peak Pulse Current	I <sub>CM</sub>	6	A
Continuous Collector Current	(Note 5)	4	
	(Note 6)	4.3	
Base Current	I <sub>B</sub>	1	

**Thermal Characteristics** (@T<sub>A</sub> = +25°C, unless otherwise specified.)

Characteristic	Symbol	Value	Unit
Power Dissipation	P <sub>D</sub>	1.5	W
		12	
Linear Derating Factor		2.45	mW/°C
		19.6	
Thermal Resistance, Junction to Ambient	R <sub>θJA</sub>	83	°C/W
		51	
Thermal Resistance, Junction to Lead	R <sub>θJL</sub>	16.8	
Operating and Storage Temperature Range	T <sub>J</sub> , T <sub>STG</sub>	-55 to +150	°C

**ESD Ratings** (Note 8)

Characteristic	Symbol	Value	Unit	JEDEC Class
Electrostatic Discharge – Human Body Model	ESD HBM	4,000	V	3A
Electrostatic Discharge – Machine Model	ESD MM	400	V	C
Electrostatic Discharge – Charged Device Model	ESD CDM	1,000	V	IV

- Notes:
5. For a device mounted with the exposed collector pad on 31mm × 31mm (10cm<sup>2</sup>) 1oz copper that is on a single sided 1.6mm FR-4 PCB; device is measured under still air conditions whilst operating in a steady state. The entire exposed collector pad is attached to the heatsink.
  6. Same as Note 5, except the device is measured at t ≤ 5s.
  7. Thermal resistance from junction to solder-point (on the exposed collector pad).
  8. Refer to JEDEC specification JESD22-A114, JESD22-A115 & JESD22-C101.

**Thermal Characteristics and Derating Information**

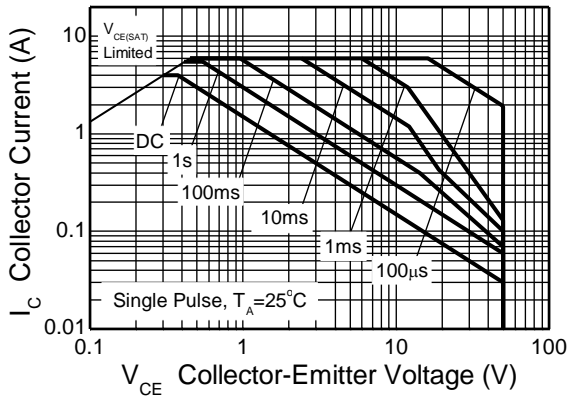

**Figure 1. Safe Operating Area**

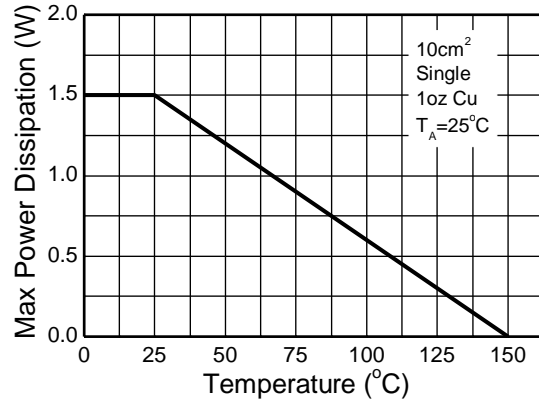

**Figure 2. Derating Curve**

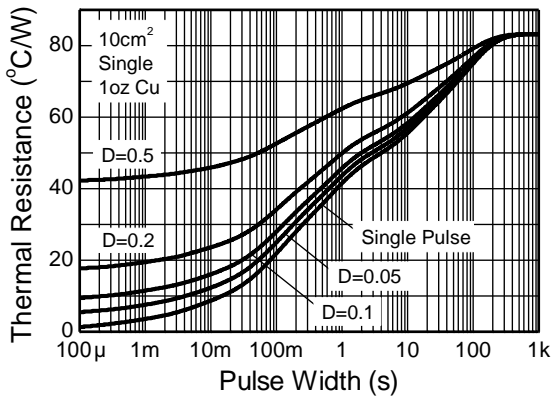

**Figure 3. Transient Thermal Impedance**

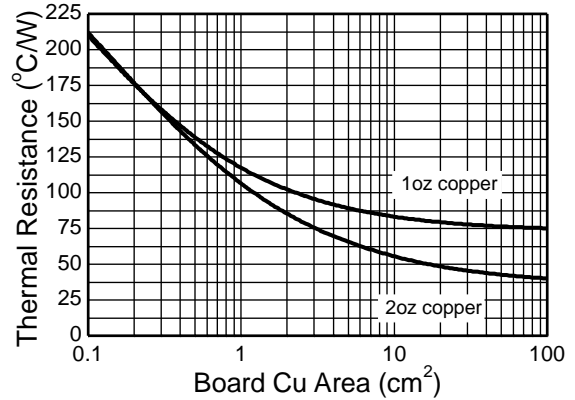

**Figure 4. Thermal Resistance v Board Area**

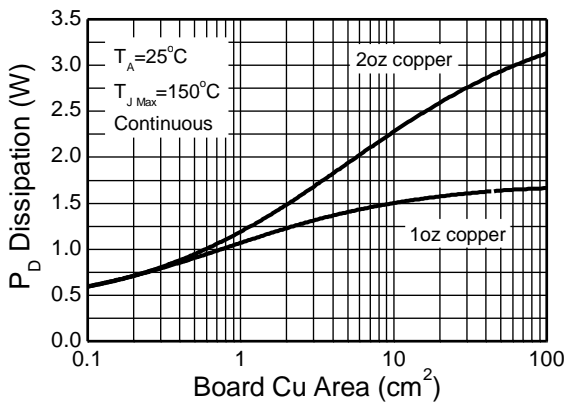

**Figure 5. Power Dissipation v Board Area**

**Electrical Characteristics** (@T<sub>A</sub> = +25°C, unless otherwise specified.)

Characteristic	Symbol	Min	Typ	Max	Unit	Test Condition
Collector-Base Breakdown Voltage	BV <sub>CB0</sub>	100	190	—	V	I <sub>C</sub> = 100μA
Collector-Emitter Breakdown Voltage (Note 9)	BV <sub>CEO</sub>	50	65	—	V	I <sub>C</sub> = 10mA
Emitter-Base Breakdown Voltage	BV <sub>EBO</sub>	7	8.2	—	V	I <sub>E</sub> = 100μA
Collector Cutoff Current	I <sub>CB0</sub>	—	—	100	nA	V <sub>CB</sub> = 80V
Emitter Cutoff Current	I <sub>EBO</sub>	—	—	20	nA	V <sub>EB</sub> = 6V
Collector Emitter Cutoff Current	I <sub>CES</sub>	—	—	100	nA	V <sub>CES</sub> = 40V
Static Forward Current Transfer Ratio (Note 9)	h <sub>FE</sub>	200	400	—	—	I <sub>C</sub> = 10mA, V <sub>CE</sub> = 2V
		300	450	—		I <sub>C</sub> = 200mA, V <sub>CE</sub> = 2V
		200	400	—		I <sub>C</sub> = 1A, V <sub>CE</sub> = 2V
		100	225	—		I <sub>C</sub> = 2A, V <sub>CE</sub> = 2V
		—	40	—		I <sub>C</sub> = 6A, V <sub>CE</sub> = 2V
Collector-Emitter Saturation Voltage (Note 9)	V <sub>CE(sat)</sub>	—	10	20	mV	I <sub>C</sub> = 0.1A, I <sub>B</sub> = 10mA
		—	70	100		I <sub>C</sub> = 1A, I <sub>B</sub> = 50mA
		—	145	200		I <sub>C</sub> = 1A, I <sub>B</sub> = 10mA
		—	150	220		I <sub>C</sub> = 2A, I <sub>B</sub> = 50mA
		—	225	300		I <sub>C</sub> = 3A, I <sub>B</sub> = 100mA
		—	270	320		I <sub>C</sub> = 4A, I <sub>B</sub> = 200mA
Base-Emitter Turn-On Voltage (Note 9)	V <sub>BE(on)</sub>	—	0.94	1.00	V	I <sub>C</sub> = 4A, V <sub>CE</sub> = 2V
Base-Emitter Saturation Voltage (Note 9)	V <sub>BE(sat)</sub>	—	1.00	1.07	V	I <sub>C</sub> = 4A, I <sub>B</sub> = 200mA
Output Capacitance	C <sub>OBO</sub>	—	12	20	pF	V <sub>CB</sub> = 10V, f = 1MHz
Transition Frequency	f <sub>T</sub>	100	165	—	MHz	V <sub>CE</sub> = 10V, I <sub>C</sub> = 50mA f = 100MHz
Turn-On Time	t <sub>on</sub>	—	170	—	ns	V <sub>CC</sub> = 10V, I <sub>C</sub> = 1A
Turn-Off Time	t <sub>off</sub>	—	750	—	ns	I <sub>B1</sub> = -I <sub>B2</sub> = 10mA

Note: 9. Measured under pulsed conditions. Pulse width ≤ 300μs. Duty cycle ≤ 2%.

**Typical Electrical Characteristics** (@ $T_A = +25^\circ\text{C}$ , unless otherwise specified.)

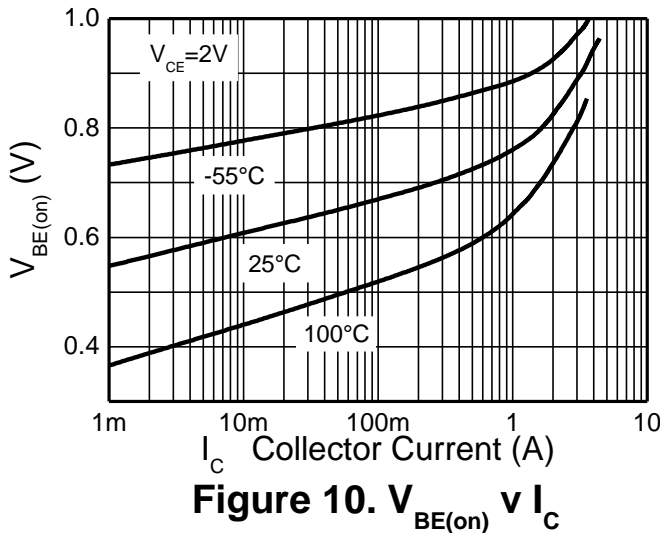
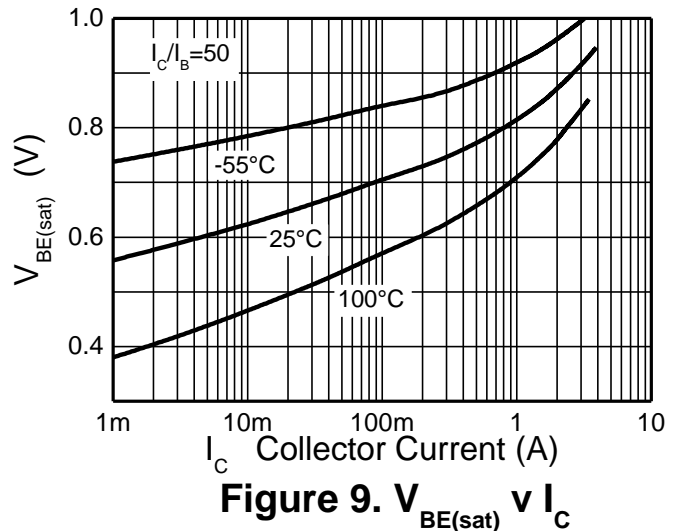
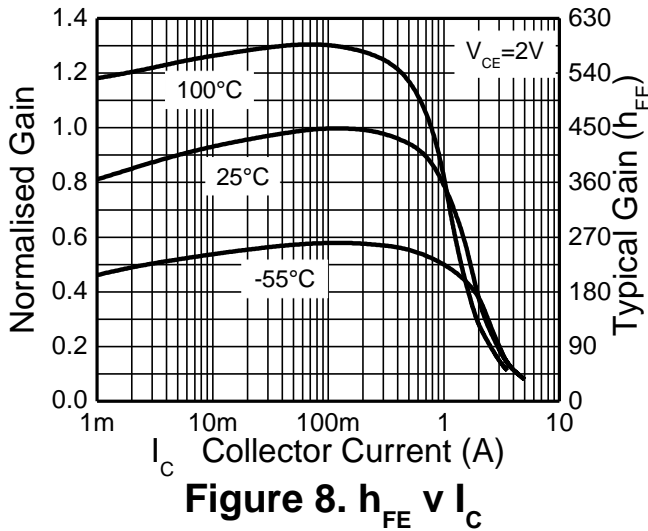
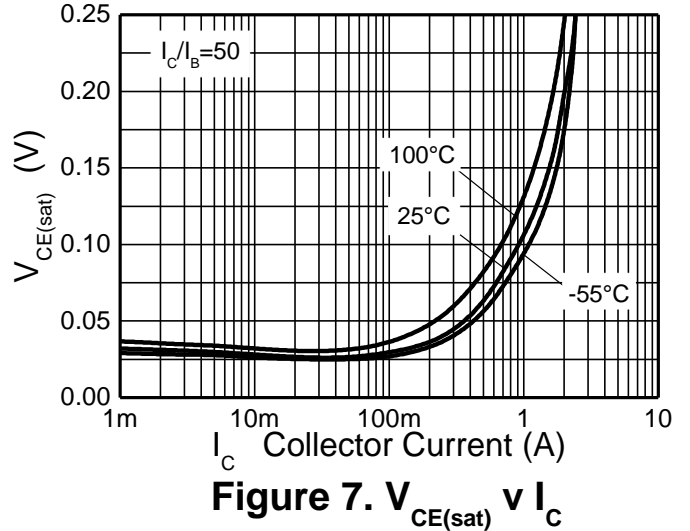
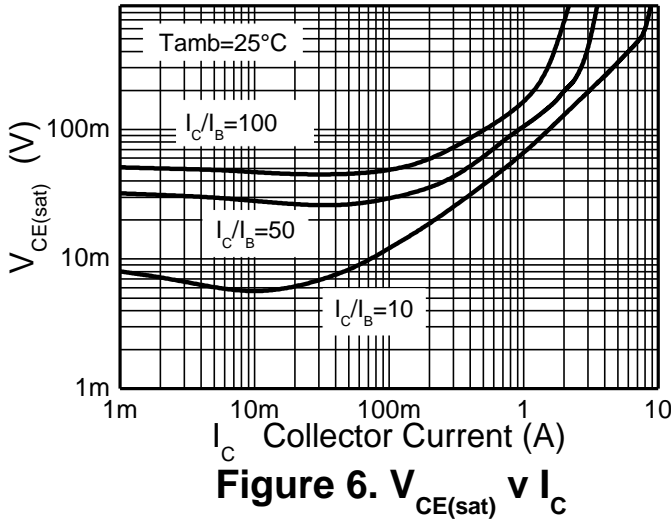

**Package Outline Dimensions**

Please see <http://www.diodes.com/package-outlines.html> for the latest version.

**U-DFN2020-3 (Type B)**

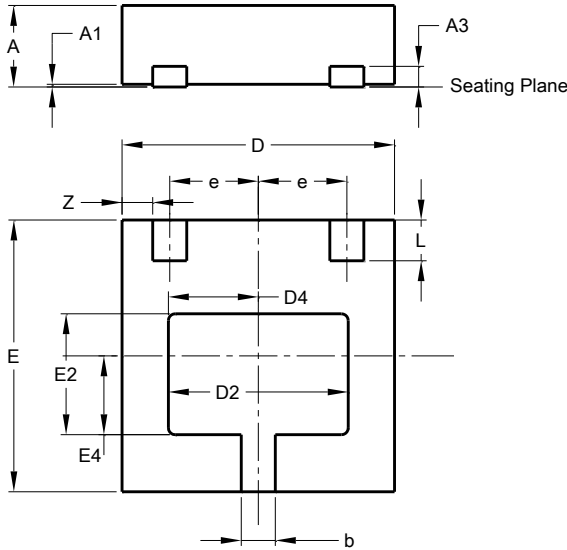

U-DFN2020-3 (Type B)			
Dim	Min	Max	Typ
A	0.57	0.63	0.60
A1	0.00	0.05	0.02
A3	—	—	0.152
b	0.20	0.30	0.25
D	1.950	2.075	2.00
D2	1.22	1.42	1.32
D4	0.56	0.76	0.66
E	1.950	2.075	2.00
E2	0.79	0.99	0.89
E4	0.48	0.68	0.58
e	—	—	0.65
L	0.25	0.35	0.30
Z	—	—	0.225
All Dimensions in mm			

**Suggested Pad Layout**

Please see <http://www.diodes.com/package-outlines.html> for the latest version.

**U-DFN2020-3 (Type B)**

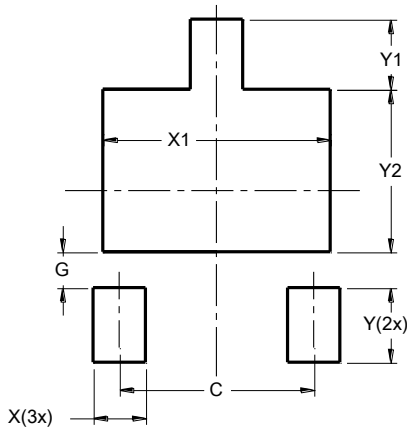

Dimensions	Value (in mm)
C	1.300
G	0.240
X	0.350
X1	1.520
Y	0.500
Y1	0.470
Y2	1.090

**IMPORTANT NOTICE**

1. DIODES INCORPORATED (Diodes) AND ITS SUBSIDIARIES MAKE NO WARRANTY OF ANY KIND, EXPRESS OR IMPLIED, WITH REGARDS TO ANY INFORMATION CONTAINED IN THIS DOCUMENT, INCLUDING, BUT NOT LIMITED TO, THE IMPLIED WARRANTIES OF MERCHANTABILITY, FITNESS FOR A PARTICULAR PURPOSE OR NON-INFRINGEMENT OF THIRD PARTY INTELLECTUAL PROPERTY RIGHTS (AND THEIR EQUIVALENTS UNDER THE LAWS OF ANY JURISDICTION).
2. The Information contained herein is for informational purpose only and is provided only to illustrate the operation of Diodes' products described herein and application examples. Diodes does not assume any liability arising out of the application or use of this document or any product described herein. This document is intended for skilled and technically trained engineering customers and users who design with Diodes' products. Diodes' products may be used to facilitate safety-related applications; however, in all instances customers and users are responsible for (a) selecting the appropriate Diodes products for their applications, (b) evaluating the suitability of Diodes' products for their intended applications, (c) ensuring their applications, which incorporate Diodes' products, comply the applicable legal and regulatory requirements as well as safety and functional-safety related standards, and (d) ensuring they design with appropriate safeguards (including testing, validation, quality control techniques, redundancy, malfunction prevention, and appropriate treatment for aging degradation) to minimize the risks associated with their applications.
3. Diodes assumes no liability for any application-related information, support, assistance or feedback that may be provided by Diodes from time to time. Any customer or user of this document or products described herein will assume all risks and liabilities associated with such use, and will hold Diodes and all companies whose products are represented herein or on Diodes' websites, harmless against all damages and liabilities.
4. Products described herein may be covered by one or more United States, international or foreign patents and pending patent applications. Product names and markings noted herein may also be covered by one or more United States, international or foreign trademarks and trademark applications. Diodes does not convey any license under any of its intellectual property rights or the rights of any third parties (including third parties whose products and services may be described in this document or on Diodes' website) under this document.
5. Diodes' products are provided subject to Diodes' Standard Terms and Conditions of Sale (<https://www.diodes.com/about/company/terms-and-conditions/terms-and-conditions-of-sales/>) or other applicable terms. This document does not alter or expand the applicable warranties provided by Diodes. Diodes does not warrant or accept any liability whatsoever in respect of any products purchased through unauthorized sales channel.
6. Diodes' products and technology may not be used for or incorporated into any products or systems whose manufacture, use or sale is prohibited under any applicable laws and regulations. Should customers or users use Diodes' products in contravention of any applicable laws or regulations, or for any unintended or unauthorized application, customers and users will (a) be solely responsible for any damages, losses or penalties arising in connection therewith or as a result thereof, and (b) indemnify and hold Diodes and its representatives and agents harmless against any and all claims, damages, expenses, and attorney fees arising out of, directly or indirectly, any claim relating to any noncompliance with the applicable laws and regulations, as well as any unintended or unauthorized application.
7. While efforts have been made to ensure the information contained in this document is accurate, complete and current, it may contain technical inaccuracies, omissions and typographical errors. Diodes does not warrant that information contained in this document is error-free and Diodes is under no obligation to update or otherwise correct this information. Notwithstanding the foregoing, Diodes reserves the right to make modifications, enhancements, improvements, corrections or other changes without further notice to this document and any product described herein. This document is written in English but may be translated into multiple languages for reference. Only the English version of this document is the final and determinative format released by Diodes.
8. Any unauthorized copying, modification, distribution, transmission, display or other use of this document (or any portion hereof) is prohibited. Diodes assumes no responsibility for any losses incurred by the customers or users or any third parties arising from any such unauthorized use.
9. This Notice may be periodically updated with the most recent version available at <https://www.diodes.com/about/company/terms-and-conditions/important-notice>

The Diodes logo is a registered trademark of Diodes Incorporated in the United States and other countries.  
All other trademarks are the property of their respective owners.  
© 2024 Diodes Incorporated. All Rights Reserved.

[www.diodes.com](http://www.diodes.com)

## Looking for pricing, stock, or lifecycle information?

Click below to explore more details on WIN SOURCE:

- ⊖ [View ZXTN619MATA on WIN SOURCE](#)
- ⊖ [Diodes Incorporated Information](#)

## Optimize Your Supply Chain with WIN SOURCE Solutions

- ✓ Global Sourcing Solution
- ✓ Obsolete Management
- ✓ Cost Control Management
- ✓ Shortage Management
- ✓ Alternative Solution
- ✓ Excess Inventory Management