

3-TERMINAL POSITIVE VOLTAGE REGULATOR

■ GENERAL DESCRIPTION

The **NJM78L00** series of 3-Terminal Positive Voltage Regulators is constructed using the New JRC Planar epitaxial process. These regulators employ internal current-limiting and thermal-shutdown, making them essentially indestructible. If adequate heat sinking is provided, they can deliver up to 100mA output current. They are intended as fixed voltage regulators in a wide range of applications including local or on-card regulation for elimination of noise and distribution problems associated with single-point regulation. In addition, they can be used with power pass elements to make high-current voltage regulators. The **NJM78L00** series used as a Zener diode/resistor combination replacement, offers an effective output impedance improvement of typically two orders of magnitude, along with lower quiescent current and lower noise.

■ PACKAGE OUTLINE

(TO-92)

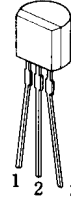

NJM78L00A

- 1.OUT
- 2.GND
- 3.IN

(SOT-89)

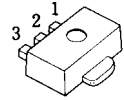

NJM78L00UA

- 1.OUT
- 2.GND
- 3.IN

■ FEATURES

- Internal Short Circuit Current Limit
- Internal Thermal Overload Protection
- Excellent Ripple Rejection
- Guarantee'd 100mA Output Current
- Package Outline
- Bipolar Technology

TO-92, SOT-89

■ EQUIVALENT CIRCUIT

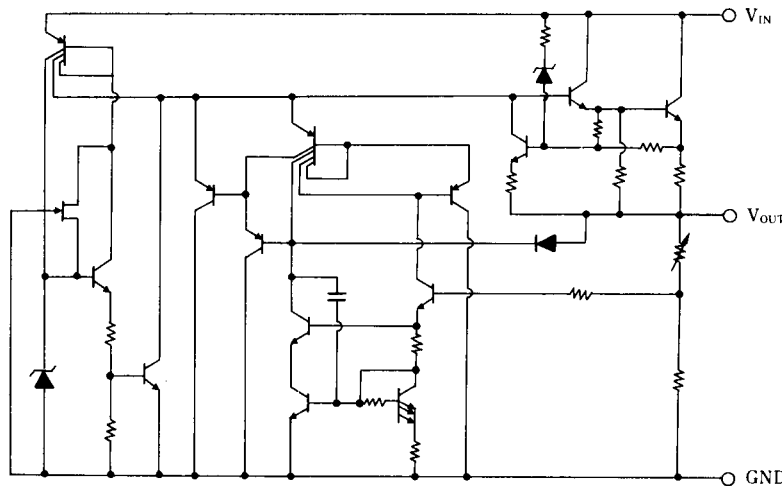

NJM78L00

■ ABSOLUTE MAXIMUM RATINGS

(T_a=25°C)

PARAMETER	SYMBOL	MAXIMUM RATINGS	UNIT
Input Voltage	V _{IN}	(78L02A to 78L09A) 30	V
		(78L12A to 78L15A) 35	
		(78L18A to 78L24A) 40	
Power Dissipation	P _D	(TO-92) 500	mW
		(EMP8) 350	
		(SOT-89) 300	
Operating Temperature Range	T _{opr}	-40 to +85	°C
Storage Temperature Range	T _{stg}	-40 to +150	°C

■ ELECTRICAL CHARACTERISTICS(C_{IN}=0.33μF, C_O=0.1μF, T_J=25°C)

Measurement is to be conducted is pulse testing.

PARAMETER	SYMBOL	TEST CONDITION	MIN.	TYP.	MAX.	UNIT
NJM78L02A						
Output Voltage	V _O	V _{IN} =9V, I _O =40mA	2.47	2.6	2.73	V
Line Regulation 1	ΔV _O -V _{IN1}	V _{IN} =4.75V to 20V, I _O =40mA	-	-	125	mV
Line Regulation 2	ΔV _O -V _{IN2}	V _{IN} =5V to 20V, I _O =40mA	-	-	100	mV
Load Regulation 1	ΔV _O -I _{O1}	V _{IN} =9V, I _O =1 to 40mA	-	-	25	mV
Load Regulation 2	ΔV _O -I _{O2}	V _{IN} =9V, I _O =1 to 100mA	-	-	50	mV
Quiescent Current	I _Q	V _{IN} =9V, I _O =0mA	-	2.0	6	mA
Average Temperature Coefficient of Output Voltage	ΔV _O /ΔT	V _{IN} =9V, I _O =1mA	-	0.2	-	mV/°C
Ripple Rejection	RR	6V < V _{IN} < 16V, I _O =40mA, e _{in} =1V _{P-P} , f=120Hz	43	73	-	dB
Output Noise Voltage	V _{NO}	V _{IN} =9V, BW=10Hz to 100kHz, I _O =40mA	-	35	-	μV
NJM78L03A(*1)						
Output Voltage	V _O	V _{IN} =9V, I _O =40mA	2.85	3.0	3.15	V
Line Regulation 1	ΔV _O -V _{IN1}	V _{IN} =5V to 20V, I _O =40mA	-	-	125	mV
Line Regulation 2	ΔV _O -V _{IN2}	V _{IN} =6V to 20V, I _O =40mA	-	-	100	mV
Load Regulation 1	ΔV _O -I _{O1}	V _{IN} =9V, I _O =1 to 40mA	-	-	25	mV
Load Regulation 2	ΔV _O -I _{O2}	V _{IN} =9V, I _O =1 to 100mA	-	-	50	mV
Quiescent Current	I _Q	V _{IN} =9V, I _O =0mA	-	2.0	6	mA
Average Temperature Coefficient of Output Voltage	ΔV _O /ΔT	V _{IN} =9V, I _O =1mA	-	0.2	-	mV/°C
Ripple Rejection	RR	6V < V _{IN} < 16V, I _O =40mA, e _{in} =1V _{P-P} , f=120Hz	43	72	-	dB
Output Noise Voltage	V _{NO}	V _{IN} =9V, BW=10Hz to 100kHz, I _O =40mA	-	40	-	μV
NJM78L05A(*3)						
Output Voltage	V _O	V _{IN} =10V, I _O =40mA	4.75	5.0	5.25	V
Line Regulation 1	ΔV _O -V _{IN1}	V _{IN} =7V to 20V, I _O =40mA	-	-	200	mV
Line Regulation 2	ΔV _O -V _{IN2}	V _{IN} =8V to 20V, I _O =40mA	-	-	150	mV
Load Regulation 1	ΔV _O -I _{O1}	V _{IN} =10V, I _O =1 to 40mA	-	-	30	mV
Load Regulation 2	ΔV _O -I _{O2}	V _{IN} =10V, I _O =1 to 100mA	-	-	60	mV
Quiescent Current	I _Q	V _{IN} =10V, I _O =0mA	-	2.0	6	mA
Average Temperature Coefficient of Output Voltage	ΔV _O /ΔT	V _{IN} =10V, I _O =1mA	-	0.4	-	mV/°C
Ripple Rejection	RR	8V < V _{IN} < 18V, I _O =40mA, e _{in} =1V _{P-P} , f=120Hz	40	69	-	dB
Output Noise Voltage	V _{NO}	V _{IN} =10V, BW=10Hz to 100kHz, I _O =40mA	-	70	-	μV

(*1) : SOT-89 package only.

(*2) : TO-92 package only.

(*3) : SOT-89, TO-92, EMP8

■ **ELECTRICAL CHARACTERISTICS**($C_{IN}=0.33\mu F$, $C_O=0.1\mu F$, $T_j=25^\circ C$)

Measurement is to be conducted is pulse testing.

PARAMETER	SYMBOL	TEST CONDITION	MIN.	TYP.	MAX.	UNIT
NJM78L06A						
Output Voltage	V_O	$V_{IN}=12V, I_O=40mA$	5.7	6.0	6.3	V
Line Regulation 1	ΔV_O-V_{IN1}	$V_{IN}=8.5V$ to $20V, I_O=40mA$	-	-	200	mV
Line Regulation 2	ΔV_O-V_{IN2}	$V_{IN}=9V$ to $20V, I_O=40mA$	-	-	150	mV
Load Regulation 1	ΔV_O-I_{O1}	$V_{IN}=12V, I_O=1$ to $40mA$	-	-	40	mV
Load Regulation 2	ΔV_O-I_{O2}	$V_{IN}=12V, I_O=1$ to $100mA$	-	-	80	mV
Quiescent Current	I_Q	$V_{IN}=12V, I_O=0mA$	-	2.0	6	mA
Average Temperature Coefficient of Output Voltage	$\Delta V_O/\Delta T$	$V_{IN}=12V, I_O=1mA$	-	0.5	-	mV/°C
Ripple Rejection	RR	$9V < V_{IN} < 20V, I_O=40mA, e_{in}=1V_{P-P}, f=120Hz$	40	67	-	dB
Output Noise Voltage	V_{NO}	$V_{IN}=12V, BW=10Hz$ to $100kHz, I_O=40mA$	-	80	-	μV
NJM78L62A(*2)						
Output Voltage	V_O	$V_{IN}=12.2V, I_O=40mA$	5.89	6.2	6.51	V
Line Regulation 1	ΔV_O-V_{IN1}	$V_{IN}=8.7V$ to $20.2V, I_O=40mA$	-	-	200	mV
Line Regulation 2	ΔV_O-V_{IN2}	$V_{IN}=9.2V$ to $20.2V, I_O=40mA$	-	-	150	mV
Load Regulation 1	ΔV_O-I_{O1}	$V_{IN}=12.2V, I_O=1$ to $40mA$	-	-	40	mV
Load Regulation 2	ΔV_O-I_{O2}	$V_{IN}=12.2V, I_O=1$ to $100mA$	-	-	85	mV
Quiescent Current	I_Q	$V_{IN}=12.2V, I_O=0mA$	-	2.0	6	mA
Average Temperature Coefficient of Output Voltage	$\Delta V_O/\Delta T$	$V_{IN}=12.2V, I_O=1mA$	-	0.5	-	mV/°C
Ripple Rejection	RR	$9.2V < V_{IN} < 20.2V, I_O=40mA, e_{in}=1V_{P-P}, f=120Hz$	40	67	-	dB
Output Noise Voltage	V_{NO}	$V_{IN}=12.2V, BW=10Hz$ to $100kHz, I_O=40mA$	-	85	-	μV
NJM78L07A						
Output Voltage	V_O	$V_{IN}=13V, I_O=40mA$	6.65	7.0	7.35	V
Line Regulation 1	ΔV_O-V_{IN1}	$V_{IN}=9.5V$ to $22V, I_O=40mA$	-	-	210	mV
Line Regulation 2	ΔV_O-V_{IN2}	$V_{IN}=10V$ to $22V, I_O=40mA$	-	-	160	mV
Load Regulation 1	ΔV_O-I_{O1}	$V_{IN}=13V, I_O=1$ to $40mA$	-	-	45	mV
Load Regulation 2	ΔV_O-I_{O2}	$V_{IN}=13V, I_O=1$ to $100mA$	-	-	90	mV
Quiescent Current	I_Q	$V_{IN}=13V, I_O=0mA$	-	2.1	6	mA
Average Temperature Coefficient of Output Voltage	$\Delta V_O/\Delta T$	$V_{IN}=13V, I_O=1mA$	-	0.55	-	mV/°C
Ripple Rejection	RR	$10V < V_{IN} < 20V, I_O=40mA, e_{in}=1V_{P-P}, f=120Hz$	39	66	-	dB
Output Noise Voltage	V_{NO}	$V_{IN}=13V, BW=10Hz$ to $100kHz, I_O=40mA$	-	100	-	μV
NJM78L08A						
Output Voltage	V_O	$V_{IN}=14V, I_O=40mA$	7.6	8.0	8.4	V
Line Regulation 1	ΔV_O-V_{IN1}	$V_{IN}=10.5V$ to $23V, I_O=40mA$	-	-	225	mV
Line Regulation 2	ΔV_O-V_{IN2}	$V_{IN}=11V$ to $23V, I_O=40mA$	-	-	175	mV
Load Regulation 1	ΔV_O-I_{O1}	$V_{IN}=14V, I_O=1$ to $40mA$	-	-	50	mV
Load Regulation 2	ΔV_O-I_{O2}	$V_{IN}=14V, I_O=1$ to $100mA$	-	-	100	mV
Quiescent Current	I_Q	$V_{IN}=14V, I_O=0mA$	-	2.1	6	mA
Average Temperature Coefficient of Output Voltage	$\Delta V_O/\Delta T$	$V_{IN}=14V, I_O=1mA$	-	0.6	-	mV/°C
Ripple Rejection	RR	$11V < V_{IN} < 20V, I_O=40mA, e_{in}=1V_{P-P}, f=120Hz$	39	66	-	dB
Output Noise Voltage	V_{NO}	$V_{IN}=14V, BW=10Hz$ to $100kHz, I_O=40mA$	-	115	-	μV

(*1) : SOT-89 package only.

(*2) : TO-92 package only.

(*3) : SOT-89, TO-92, EMP8

NJM78L00

■ ELECTRICAL CHARACTERISTICS($C_{IN}=0.33\mu F$, $C_O=0.1\mu F$, $T_j=25^\circ C$)

Measurement is to be conducted is pulse testing.

PARAMETER	SYMBOL	TEST CONDITION	MIN.	TYP.	MAX.	UNIT
NJM78L09A(*3)						
Output Voltage	V_O	$V_{IN}=15V$, $I_O=40mA$	8.55	9.0	9.45	V
Line Regulation 1	ΔV_O-V_{IN1}	$V_{IN}=11.5V$ to $23V$, $I_O=40mA$	-	-	250	mV
Line Regulation 2	ΔV_O-V_{IN2}	$V_{IN}=12V$ to $23V$, $I_O=40mA$	-	-	200	mV
Load Regulation 1	ΔV_O-I_{O1}	$V_{IN}=15V$, $I_O=1$ to $40mA$	-	-	50	mV
Load Regulation 2	ΔV_O-I_{O2}	$V_{IN}=15V$, $I_O=1$ to $100mA$	-	-	100	mV
Quiescent Current	I_Q	$V_{IN}=15V$, $I_O=0mA$	-	2.1	6	mA
Average Temperature Coefficient of Output Voltage	$\Delta V_O/\Delta T$	$V_{IN}=15V$, $I_O=1mA$	-	0.65	-	mV/ $^\circ C$
Ripple Rejection	RR	$12V < V_{IN} < 21V$, $I_O=40mA$, $e_{in}=1V_{P-P}$, $f=120Hz$	38	65	-	dB
Output Noise Voltage	V_{NO}	$V_{IN}=15V$, $BW=10Hz$ to $100kHz$, $I_O=40mA$	-	125	-	μV
NJM78L10A						
Output Voltage	V_O	$V_{IN}=16V$, $I_O=40mA$	9.5	10.0	10.5	V
Line Regulation 1	ΔV_O-V_{IN1}	$V_{IN}=13V$ to $25V$, $I_O=40mA$	-	-	250	mV
Line Regulation 2	ΔV_O-V_{IN2}	$V_{IN}=14V$ to $25V$, $I_O=40mA$	-	-	200	mV
Load Regulation 1	ΔV_O-I_{O1}	$V_{IN}=16V$, $I_O=1$ to $40mA$	-	-	50	mV
Load Regulation 2	ΔV_O-I_{O2}	$V_{IN}=16V$, $I_O=1$ to $100mA$	-	-	100	mV
Quiescent Current	I_Q	$V_{IN}=16V$, $I_O=0mA$	-	2.1	6	mA
Average Temperature Coefficient of Output Voltage	$\Delta V_O/\Delta T$	$V_{IN}=16V$, $I_O=1mA$	-	0.7	-	mV/ $^\circ C$
Ripple Rejection	RR	$13V < V_{IN} < 22V$, $I_O=40mA$, $e_{in}=1V_{P-P}$, $f=120Hz$	37	64	-	dB
Output Noise Voltage	V_{NO}	$V_{IN}=16V$, $BW=10Hz$ to $100kHz$, $I_O=40mA$	-	135	-	μV
NJM78L12A(*3)						
Output Voltage	V_O	$V_{IN}=19V$, $I_O=40mA$	11.4	12.0	12.6	V
Line Regulation 1	ΔV_O-V_{IN1}	$V_{IN}=14.5V$ to $27V$, $I_O=40mA$	-	-	250	mV
Line Regulation 2	ΔV_O-V_{IN2}	$V_{IN}=16V$ to $27V$, $I_O=40mA$	-	-	200	mV
Load Regulation 1	ΔV_O-I_{O1}	$V_{IN}=19V$, $I_O=1$ to $40mA$	-	-	50	mV
Load Regulation 2	ΔV_O-I_{O2}	$V_{IN}=19V$, $I_O=1$ to $100mA$	-	-	100	mV
Quiescent Current	I_Q	$V_{IN}=19V$, $I_O=0mA$	-	2.1	6.5	mA
Average Temperature Coefficient of Output Voltage	$\Delta V_O/\Delta T$	$V_{IN}=19V$, $I_O=1mA$	-	0.9	-	mV/ $^\circ C$
Ripple Rejection	RR	$15V < V_{IN} < 25V$, $I_O=40mA$, $e_{in}=1V_{P-P}$, $f=120Hz$	37	62	-	dB
Output Noise Voltage	V_{NO}	$V_{IN}=19V$, $BW=10Hz$ to $100kHz$, $I_O=40mA$	-	160	-	μV
NJM78L15A						
Output Voltage	V_O	$V_{IN}=23V$, $I_O=40mA$	14.3	15.0	15.7	V
Line Regulation 1	ΔV_O-V_{IN1}	$V_{IN}=17.5V$ to $30V$, $I_O=40mA$	-	-	300	mV
Line Regulation 2	ΔV_O-V_{IN2}	$V_{IN}=20V$ to $30V$, $I_O=40mA$	-	-	250	mV
Load Regulation 1	ΔV_O-I_{O1}	$V_{IN}=23V$, $I_O=1$ to $40mA$	-	-	75	mV
Load Regulation 2	ΔV_O-I_{O2}	$V_{IN}=23V$, $I_O=1$ to $100mA$	-	-	150	mV
Quiescent Current	I_Q	$V_{IN}=23V$, $I_O=0mA$	-	2.2	6.5	mA
Average Temperature Coefficient of Output Voltage	$\Delta V_O/\Delta T$	$V_{IN}=23V$, $I_O=1mA$	-	1.0	-	mV/ $^\circ C$
Ripple Rejection	RR	$18.5V < V_{IN} < 28.5V$, $I_O=40mA$, $e_{in}=1V_{P-P}$, $f=120Hz$	34	60	-	dB
Output Noise Voltage	V_{NO}	$V_{IN}=23V$, $BW=10Hz$ to $100kHz$, $I_O=40mA$	-	190	-	μV

(*1) : SOT-89 package only.

(*2) : TO-92 package only.

(*3) : SOT-89, TO-92, EMP8

■ **ELECTRICAL CHARACTERISTICS**($C_{IN}=0.33\mu F$, $C_O=0.1\mu F$, $T_j=25^\circ C$)

Measurement is to be conducted is pulse testing.

PARAMETER	SYMBOL	TEST CONDITION	MIN.	TYP.	MAX.	UNIT
NJM78L18A						
Output Voltage	V_O	$V_{IN}=27V, I_O=40mA$	17.1	18.0	18.9	V
Line Regulation 1	ΔV_O-V_{IN1}	$V_{IN}=22V$ to $33V, I_O=40mA$	-	-	320	mV
Line Regulation 2	ΔV_O-V_{IN2}	$V_{IN}=22V$ to $33V, I_O=40mA$	-	-	270	mV
Load Regulation 1	ΔV_O-I_{O1}	$V_{IN}=27V, I_O=1$ to $40mA$	-	-	80	mV
Load Regulation 2	ΔV_O-I_{O2}	$V_{IN}=27V, I_O=1$ to $100mA$	-	-	160	mV
Quiescent Current	I_Q	$V_{IN}=27V, I_O=0mA$	-	2.2	6.5	mA
Average Temperature Coefficient of Output Voltage	$\Delta V_O/\Delta T$	$V_{IN}=27V, I_O=1mA$	-	1.1	-	mV/°C
Ripple Rejection	RR	$23V < V_{IN} < 33V, I_O=40mA, e_{in}=1V_{P-P}, f=120Hz$	33	59	-	dB
Output Noise Voltage	V_{NO}	$V_{IN}=27V, BW=10Hz$ to $100kHz, I_O=40mA$	-	230	-	μV
NJM78L20A						
Output Voltage	V_O	$V_{IN}=29V, I_O=40mA$	19.0	20.0	21.0	V
Line Regulation 1	ΔV_O-V_{IN1}	$V_{IN}=23V$ to $34V, I_O=40mA$	-	-	330	mV
Line Regulation 2	ΔV_O-V_{IN2}	$V_{IN}=24V$ to $34V, I_O=40mA$	-	-	280	mV
Load Regulation 1	ΔV_O-I_{O1}	$V_{IN}=29V, I_O=1$ to $40mA$	-	-	90	mV
Load Regulation 2	ΔV_O-I_{O2}	$V_{IN}=29V, I_O=1$ to $100mA$	-	-	180	mV
Quiescent Current	I_Q	$V_{IN}=29V, I_O=0mA$	-	2.3	7	mA
Average Temperature Coefficient of Output Voltage	$\Delta V_O/\Delta T$	$V_{IN}=29V, I_O=1mA$	-	1.2	-	mV/°C
Ripple Rejection	RR	$24V < V_{IN} < 34V, I_O=40mA, e_{in}=1V_{P-P}, f=120Hz$	32	58	-	dB
Output Noise Voltage	V_{NO}	$V_{IN}=29V, BW=10Hz$ to $100kHz, I_O=40mA$	-	250	-	μV
NJM78L24A						
Output Voltage	V_O	$V_{IN}=33V, I_O=40mA$	22.8	24	25.2	V
Line Regulation 1	ΔV_O-V_{IN1}	$V_{IN}=27V$ to $38V, I_O=40mA$	-	-	350	mV
Line Regulation 2	ΔV_O-V_{IN2}	$V_{IN}=28V$ to $38V, I_O=40mA$	-	-	300	mV
Load Regulation 1	ΔV_O-I_{O1}	$V_{IN}=33V, I_O=1$ to $40mA$	-	-	100	mV
Load Regulation 2	ΔV_O-I_{O2}	$V_{IN}=33V, I_O=1$ to $100mA$	-	-	200	mV
Quiescent Current	I_Q	$V_{IN}=33V, I_O=0mA$	-	2.3	7	mA
Average Temperature Coefficient of Output Voltage	$\Delta V_O/\Delta T$	$V_{IN}=33V, I_O=1mA$	-	1.4	-	mV/°C
Ripple Rejection	RR	$27.5V < V_{IN} < 37.5V, I_O=40mA, e_{in}=1V_{P-P}, f=120Hz$	32	57	-	dB
Output Noise Voltage	V_{NO}	$V_{IN}=33V, BW=10Hz$ to $100kHz, I_O=40mA$	-	280	-	μV

(*1) : SOT-89 package only.

(*2) : TO-92 package only.

(*3) : SOT-89, TO-92, EMP8

■ **SOT-89 MARK**

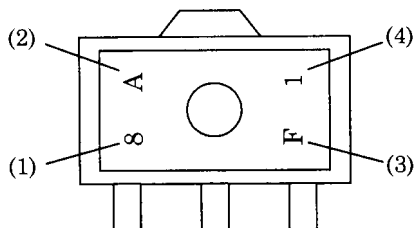

(1) 8 : Positive Output

(2) V_O Rank

(3) The end of A.D.

(4) Production Mouth

Oct. ...X

Nov. ...Y

Dec. ...Z

NJM78L02A	8	A
NJM78L03A	8	B
NJM78L05A	8	C
NJM78L06A	8	E
NJM78L62A	8	Z
NJM78L07A	8	F
NJM78L08A	8	G
NJM78L09A	8	H
NJM78L10A	8	J
NJM78L12A	8	K
NJM78L15A	8	L
NJM78L18A	8	M
NJM78L20A	8	N
NJM78L24A	8	P

NJM78L00

■ TEST CIRCUIT

1. Output Voltage, Line Regulation, Load Regulation, Quiescent Current, Average Temperature Coefficient of Output Voltage, Output Noise Voltage, Peak Output/Short-Circuit Current

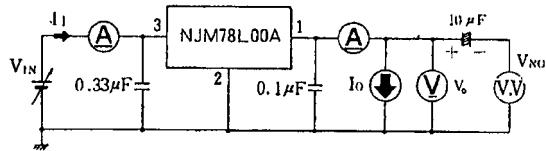

○ Measurement is to be conducted in pulse testing.
 ○ $I_Q = I_1 - I_o$

2. Ripple Rejection

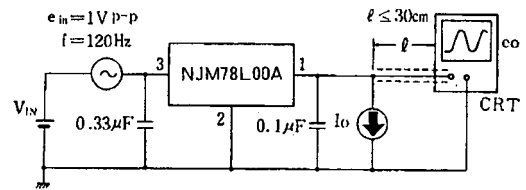

$$RR = 20 \log_{10} \left(\frac{e_{in}}{e_o} \right) \text{ (dB)}$$

■ AMBIENT TEMPERATURE VS. POWER DISSIPATION

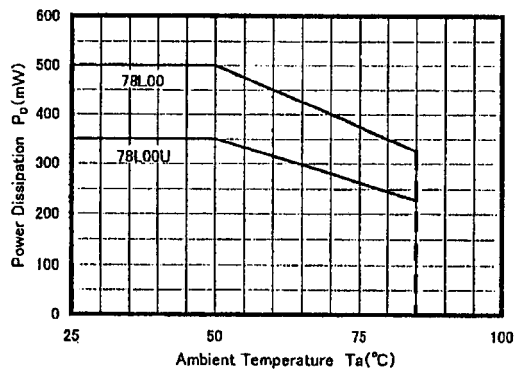

■ TYPICAL CHARACTERISTICS

NJM78L05 / L12 / L24
Output Characteristics

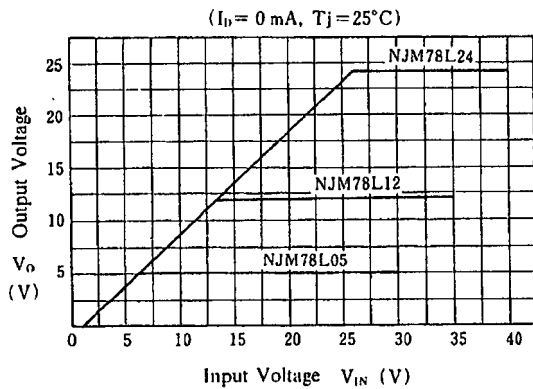

NJM78L05 Dropout Characteristics

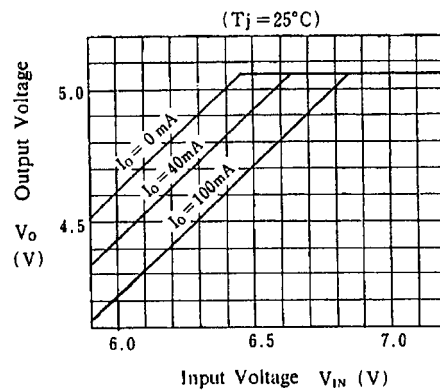

NJM78L00 Series Short Circuit
Output Current

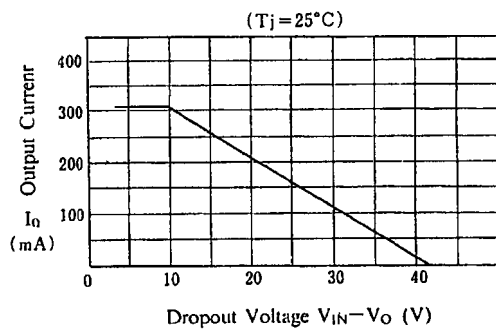

NJM78L02 / L24 Quiescent Current
vs. Output Current

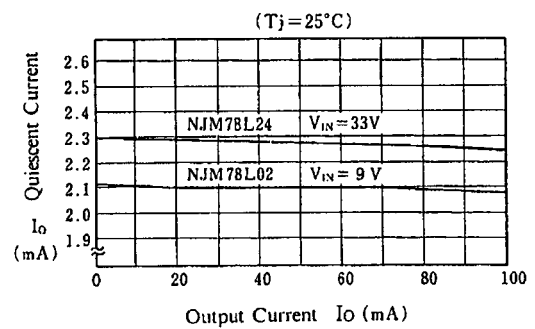

NJM78L05 Quiescent Current
vs. Input Voltage

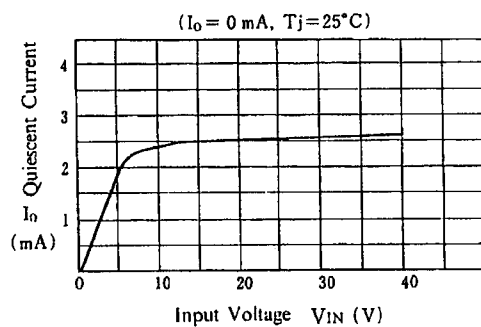

NJM78L00

■ TYPICAL CHARACTERISTICS

NJM78L05 / L12 / L24

Thermal Shutdown Characteristics

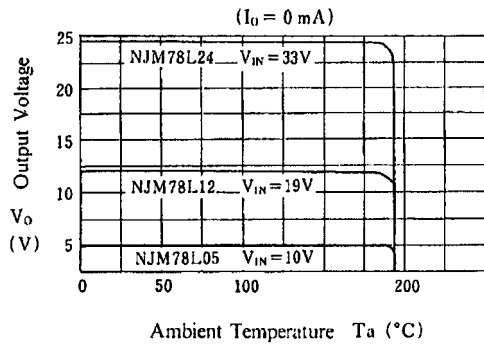

NJM78L05 / L12 / L24

Load Characteristics

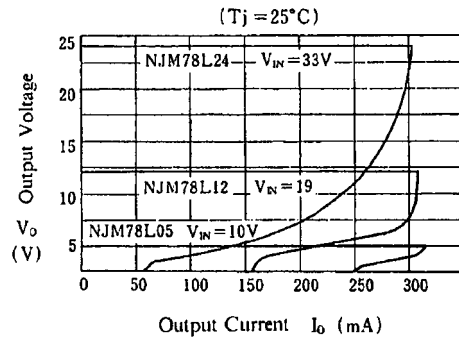

NJM78L02 / L24 Ripple Rejection

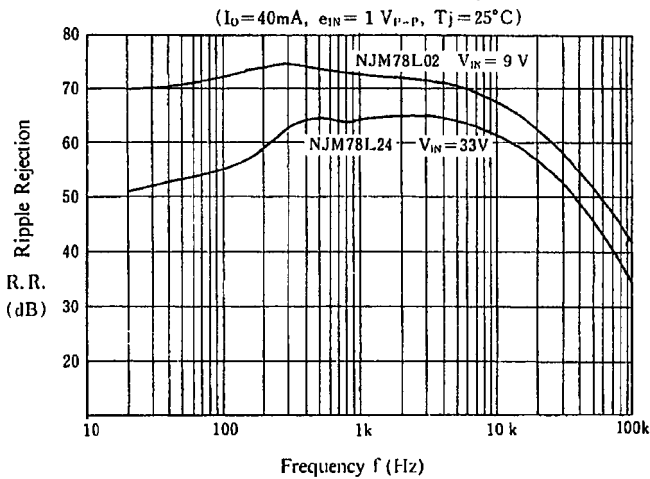

NJM78L05 Output Voltage vs. Temperature

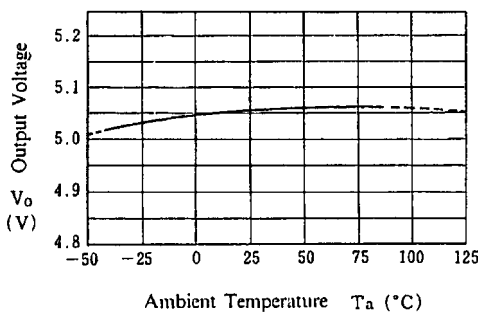

NJM78L12 Output Voltage vs. Temperature

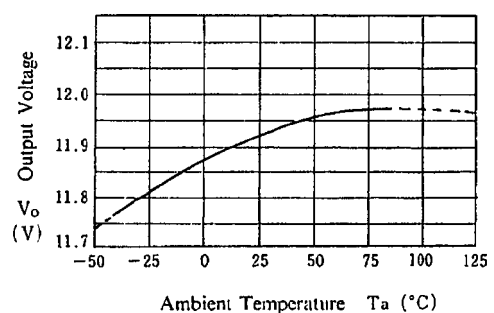

[CAUTION]

The specifications on this databook are only given for information, without any guarantee as regards either mistakes or omissions. The application circuits in this databook are described only to show representative usages of the product and not intended for the guarantee or permission of any right including the industrial rights.

Looking for pricing, stock, or lifecycle information?

Click below to explore more details on WIN SOURCE:

- ⊖ [View NJM78L05L2A on WIN SOURCE](#)
- ⊖ [NJR Corporation/NJRC Information](#)

Optimize Your Supply Chain with WIN SOURCE Solutions

- ✓ Global Sourcing Solution
- ✓ Obsolete Management
- ✓ Cost Control Management
- ✓ Shortage Management
- ✓ Alternative Solution
- ✓ Excess Inventory Management