



**THE DATASHEET OF
PDTA123ET,215**



Important notice

Dear Customer,

On 7 February 2017 the former NXP Standard Product business became a new company with the tradename **Nexperia**. Nexperia is an industry leading supplier of Discrete, Logic and PowerMOS semiconductors with its focus on the automotive, industrial, computing, consumer and wearable application markets

In data sheets and application notes which still contain NXP or Philips Semiconductors references, use the references to Nexperia, as shown below.

Instead of <http://www.nxp.com>, <http://www.philips.com/> or <http://www.semiconductors.philips.com/>, use <http://www.nexperia.com>

Instead of sales.addresses@www.nxp.com or sales.addresses@www.semiconductors.philips.com, use salesaddresses@nexperia.com (email)

Replace the copyright notice at the bottom of each page or elsewhere in the document, depending on the version, as shown below:

- © NXP N.V. (year). All rights reserved or © Koninklijke Philips Electronics N.V. (year). All rights reserved

Should be replaced with:

- © **Nexperia B.V. (year). All rights reserved.**

If you have any questions related to the data sheet, please contact our nearest sales office via e-mail or telephone (details via salesaddresses@nexperia.com). Thank you for your cooperation and understanding,

Kind regards,

Team Nexperia

DATA SHEET

PDTA123E series

PNP resistor-equipped transistors;

R1 = 2.2 k Ω , R2 = 2.2 k Ω

Product data sheet
Supersedes data of 2004 Apr 07

2004 Aug 02

PNP resistor-equipped transistors; R1 = 2.2 k Ω , R2 = 2.2 k Ω

PDTA123E series

FEATURES

- Built-in bias resistors
- Simplified circuit design
- Reduction of component count
- Reduced pick and place costs.

APPLICATIONS

- General purpose switching and amplification
- Inverter and interface circuits
- Circuit driver.

QUICK REFERENCE DATA

SYMBOL	PARAMETER	TYP.	MAX.	UNIT
V _{CEO}	collector-emitter voltage	–	–50	V
I _O	output current (DC)	–	–100	mA
R1	bias resistor	2.2	–	k Ω
R2	bias resistor	2.2	–	k Ω

DESCRIPTION

PNP resistor-equipped transistor (see “Simplified outline, symbol and pinning” for package details).

PRODUCT OVERVIEW

TYPE NUMBER	PACKAGE		MARKING CODE	NPN COMPLEMENT
	PHILIPS	EIAJ		
PDTA123EE	SOT416	SC-75	5C	PDTC123EE
PDTA123EEF	SOT490	SC-89	6C	PDTC123EEF
PDTA123EK	SOT346	SC-59	42	PDTC123EK
PDTA123EM	SOT883	SC-101	F7	PDTC123EM
PDTA123ES	SOT54 (TO-92)	SC-43	TA123E	PDTC123ES
PDTA123ET	SOT23	–	*21 ⁽¹⁾	PDTC123ET
PDTA123EU	SOT323	SC-70	*42 ⁽¹⁾	PDTC123EU

Note

1. * = p: Made in Hong Kong.
* = t: Made in Malaysia.
* = W: Made in China.

PNP resistor-equipped transistors;
 R1 = 2.2 kΩ, R2 = 2.2 kΩ

PDTA123E series

SIMPLIFIED OUTLINE, SYMBOL AND PINNING

TYPE NUMBER	SIMPLIFIED OUTLINE AND SYMBOL	PINNING	
		PIN	DESCRIPTION
PDTA123ES	<p style="text-align: center;"><i>MAM338</i></p>	1 2 3	base collector emitter
PDTA123EE PDTA123EEF PDTA123EK PDTA123ET PDTA123EU	<p style="text-align: center;">Top view <i>MDB271</i></p>	1 2 3	base emitter collector
PDTA123EM	<p style="text-align: center;">Bottom view <i>MDB267</i></p>	1 2 3	base emitter collector

PNP resistor-equipped transistors;
R1 = 2.2 k Ω , R2 = 2.2 k Ω

PDTA123E series

ORDERING INFORMATION

TYPE NUMBER	PACKAGE		
	NAME	DESCRIPTION	VERSION
PDTA123EE	–	plastic surface mounted package; 3 leads	SOT416
PDTA123EEF	–	plastic surface mounted package; 3 leads	SOT490
PDTA123EK	–	plastic surface mounted package; 3 leads	SOT346
PDTA123EM	–	leadless ultra small plastic package; 3 solder lands; body 1.0 x 0.6 x 0.5 mm	SOT883
PDTA123ES	–	plastic single-ended leaded (through hole) package; 3 leads	SOT54
PDTA123ET	–	plastic surface mounted package; 3 leads	SOT23
PDTA123EU	–	plastic surface mounted package; 3 leads	SOT323

LIMITING VALUES

In accordance with the Absolute Maximum Rating System (IEC 60134).

SYMBOL	PARAMETER	CONDITIONS	MIN.	MAX.	UNIT
V _{CB0}	collector-base voltage	open emitter	–	–50	V
V _{CEO}	collector-emitter voltage	open base	–	–50	V
V _{EBO}	emitter-base voltage	open collector	–	–10	V
V _I	input voltage				
	positive		–	+10	V
	negative		–	–12	V
I _O	output current (DC)		–	–100	mA
I _{CM}	peak collector current		–	–100	mA
P _{tot}	total power dissipation	T _{amb} ≤ 25 °C			
	SOT54	note 1	–	500	mW
	SOT23	note 1	–	250	mW
	SOT346	note 1	–	250	mW
	SOT323	note 1	–	200	mW
	SOT416	note 1	–	150	mW
	SOT490	notes 1 and 2	–	250	mW
SOT883	notes 2 and 3	–	250	mW	
T _{stg}	storage temperature		–65	+150	°C
T _j	junction temperature		–	150	°C
T _{amb}	operating ambient temperature		–65	+150	°C

Notes

1. Refer to standard mounting conditions.
2. Reflow soldering is the only recommended soldering method.
3. Refer to SOT883 standard mounting conditions; FR4 with 60 μ m copper strip line.

PNP resistor-equipped transistors;
R1 = 2.2 k Ω , R2 = 2.2 k Ω

PDTA123E series

THERMAL CHARACTERISTICS

SYMBOL	PARAMETER	CONDITIONS	VALUE	UNIT
R _{th(j-a)}	thermal resistance from junction to ambient	T _{amb} ≤ 25 °C		
	SOT54	note 1	250	K/W
	SOT23	note 1	500	K/W
	SOT346	note 1	500	K/W
	SOT323	note 1	625	K/W
	SOT416	note 1	830	K/W
	SOT490	notes 1 and 2	500	K/W
	SOT883	notes 2 and 3	500	K/W

Notes

1. Refer to standard mounting conditions.
2. Reflow soldering is the only recommended soldering method.
3. Refer to SOT883 standard mounting conditions; FR4 with 60 μ m copper strip line.

CHARACTERISTICS

T_{amb} = 25 °C unless otherwise specified.

SYMBOL	PARAMETER	CONDITIONS	MIN.	TYP.	MAX.	UNIT
I _{CBO}	collector-base cut-off current	V _{CB} = -50 V; I _E = 0 A	-	-	-100	nA
I _{CEO}	collector-emitter cut-off current	V _{CE} = -30 V; I _B = 0 A	-	-	-1	μ A
		V _{CE} = -30 V; I _B = 0 A; T _j = 150 °C	-	-	-50	μ A
I _{EBO}	emitter-base cut-off current	V _{EB} = -5 V; I _C = 0 A	-	-	-2	mA
h _{FE}	DC current gain	V _{CE} = -5 V; I _C = -20 mA	30	-	-	
V _{CEsat}	collector-emitter saturation voltage	I _C = -10 mA; I _B = -0.5 mA	-	-	-150	mV
V _{i(off)}	input-off voltage	I _C = -1 mA; V _{CE} = -5 V	-	-1.2	-0.5	V
V _{i(on)}	input-on voltage	I _C = -20 mA; V _{CE} = -0.3 V	-2	-1.6	-	V
R1	input resistor		1.54	2.2	2.86	k Ω
$\frac{R2}{R1}$	resistor ratio		0.8	1	1.2	
C _c	collector capacitance	I _E = i _e = 0 A; V _{CB} = -10 V; f = 1 MHz	-	-	3	pF

PNP resistor-equipped transistors;
R1 = 2.2 kΩ, R2 = 2.2 kΩ

PDTA123E series

PACKAGE OUTLINES

Plastic surface-mounted package; 3 leads

SOT416

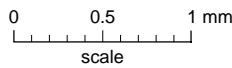
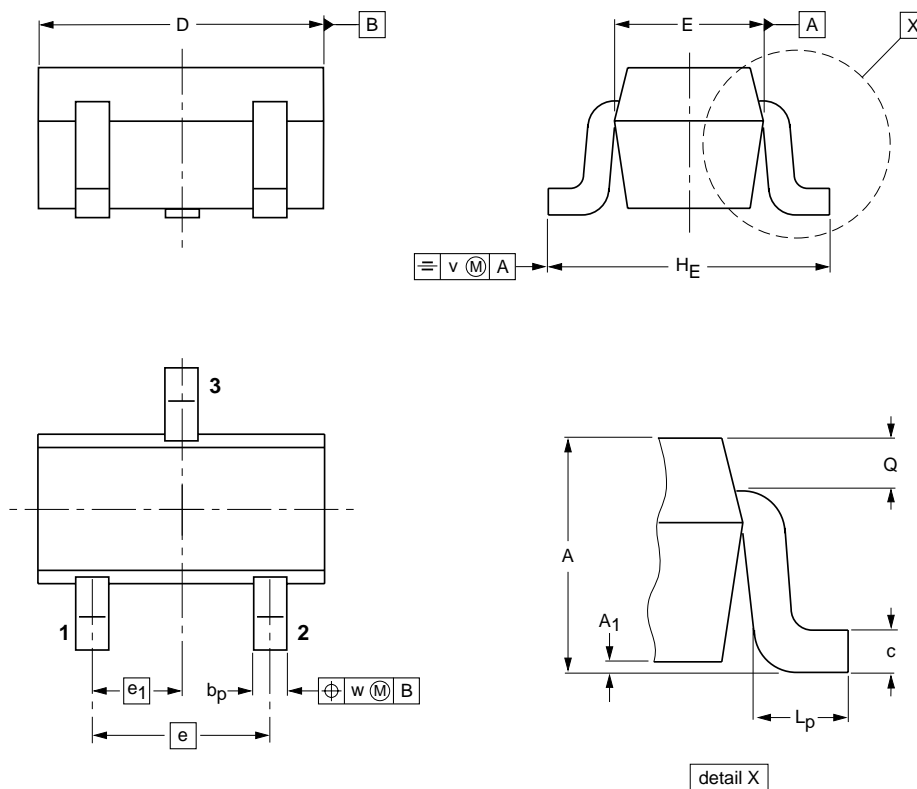

DIMENSIONS (mm are the original dimensions)

UNIT	A	A ₁ max	b _p	c	D	E	e	e ₁	H _E	L _p	Q	v	w
mm	0.95 0.60	0.1	0.30 0.15	0.25 0.10	1.8 1.4	0.9 0.7	1	0.5	1.75 1.45	0.45 0.15	0.23 0.13	0.2	0.2

OUTLINE VERSION	REFERENCES			EUROPEAN PROJECTION	ISSUE DATE
	IEC	JEDEC	JEITA		
SOT416			SC-75		04-11-04 06-03-16

PNP resistor-equipped transistors;
R1 = 2.2 kΩ, R2 = 2.2 kΩ

PDTA123E series

Plastic surface-mounted package; 3 leads

SOT490

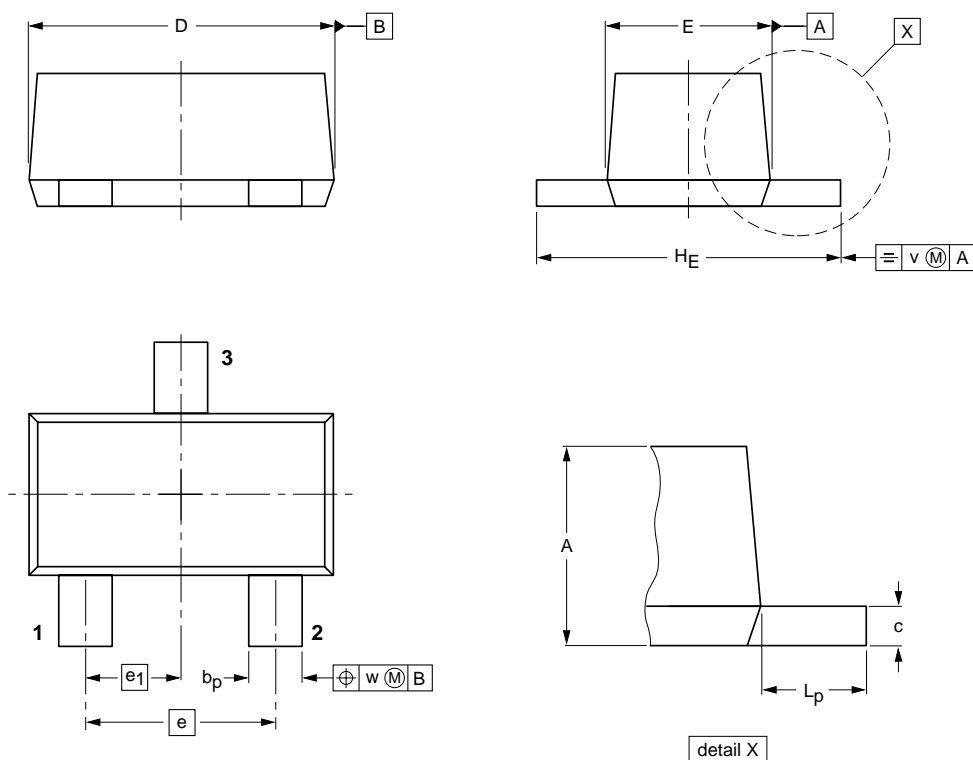

DIMENSIONS (mm are the original dimensions)

UNIT	A	b _p	c	D	E	e	e ₁	H _E	L _p	v	w
mm	0.8 0.6	0.33 0.23	0.2 0.1	1.7 1.5	0.95 0.75	1.0	0.5	1.7 1.5	0.5 0.3	0.1	0.1

OUTLINE VERSION	REFERENCES			EUROPEAN PROJECTION	ISSUE DATE
	IEC	JEDEC	JEITA		
SOT490			SC-89		05-07-28 06-03-16

PNP resistor-equipped transistors;
R1 = 2.2 kΩ, R2 = 2.2 kΩ

PDTA123E series

Plastic surface-mounted package; 3 leads

SOT346

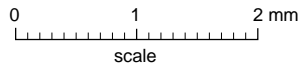
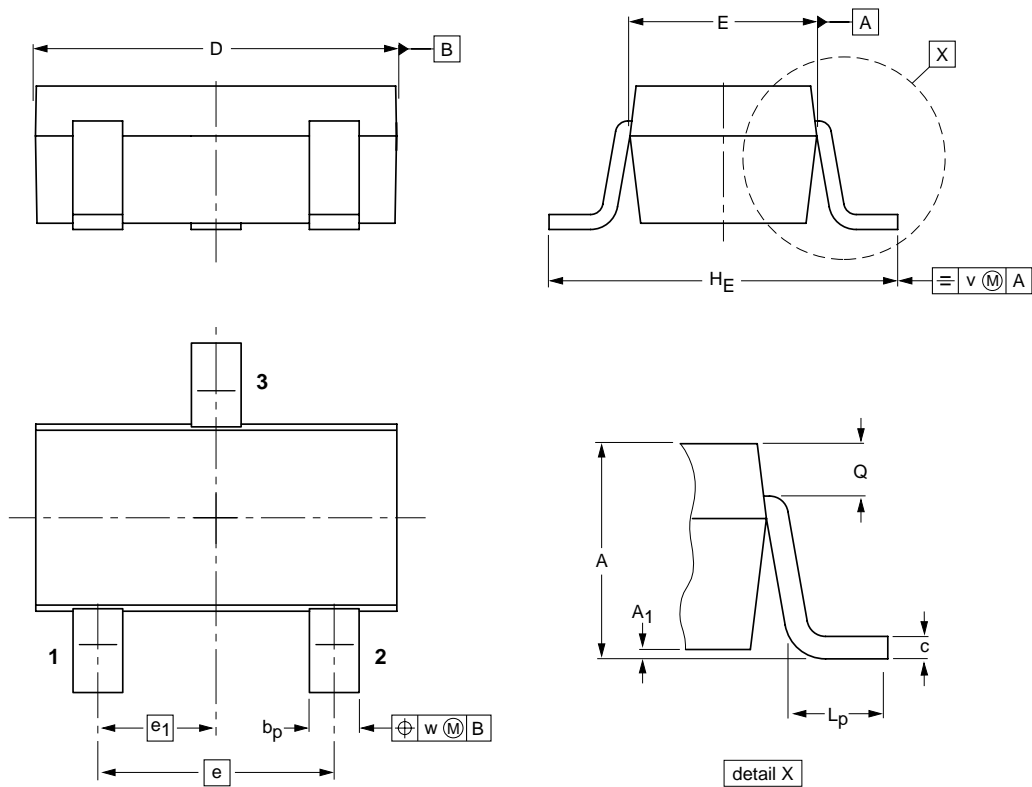

DIMENSIONS (mm are the original dimensions)

UNIT	A	A ₁	b _p	c	D	E	e	e ₁	H _E	L _p	Q	v	w
mm	1.3 1.0	0.1 0.013	0.50 0.35	0.26 0.10	3.1 2.7	1.7 1.3	1.9	0.95	3.0 2.5	0.6 0.2	0.33 0.23	0.2	0.2

OUTLINE VERSION	REFERENCES			EUROPEAN PROJECTION	ISSUE DATE
	IEC	JEDEC	JEITA		
SOT346		TO-236	SC-59A		04-11-11 06-03-16

PNP resistor-equipped transistors;
R1 = 2.2 kΩ, R2 = 2.2 kΩ

PDTA123E series

Leadless ultra small plastic package; 3 solder lands; body 1.0 x 0.6 x 0.5 mm

SOT883

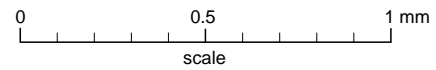
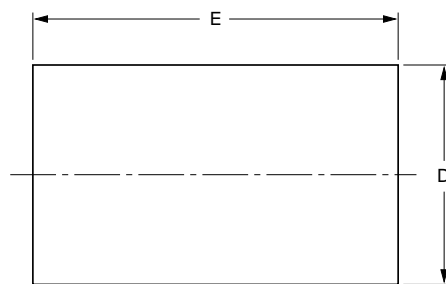
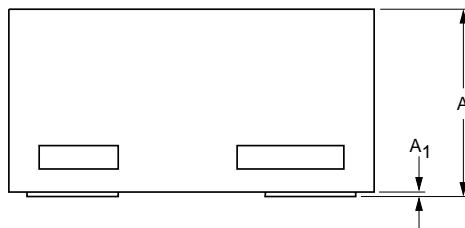
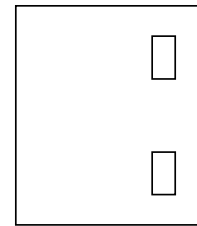
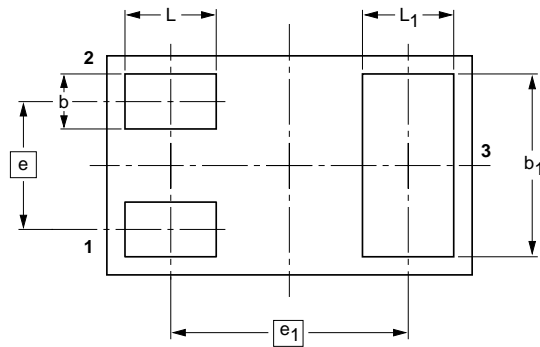

DIMENSIONS (mm are the original dimensions)

UNIT	A ⁽¹⁾	A ₁ max.	b	b ₁	D	E	e	e ₁	L	L ₁
mm	0.50 0.46	0.03	0.20 0.12	0.55 0.47	0.62 0.55	1.02 0.95	0.35	0.65	0.30 0.22	0.30 0.22

Note

1. Including plating thickness

OUTLINE VERSION	REFERENCES			EUROPEAN PROJECTION	ISSUE DATE
	IEC	JEDEC	JEITA		
SOT883			SC-101		03-02-05 03-04-03

PNP resistor-equipped transistors;
R1 = 2.2 kΩ, R2 = 2.2 kΩ

PDTA123E series

Plastic single-ended leaded (through hole) package; 3 leads

SOT54

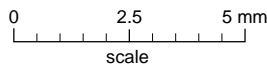
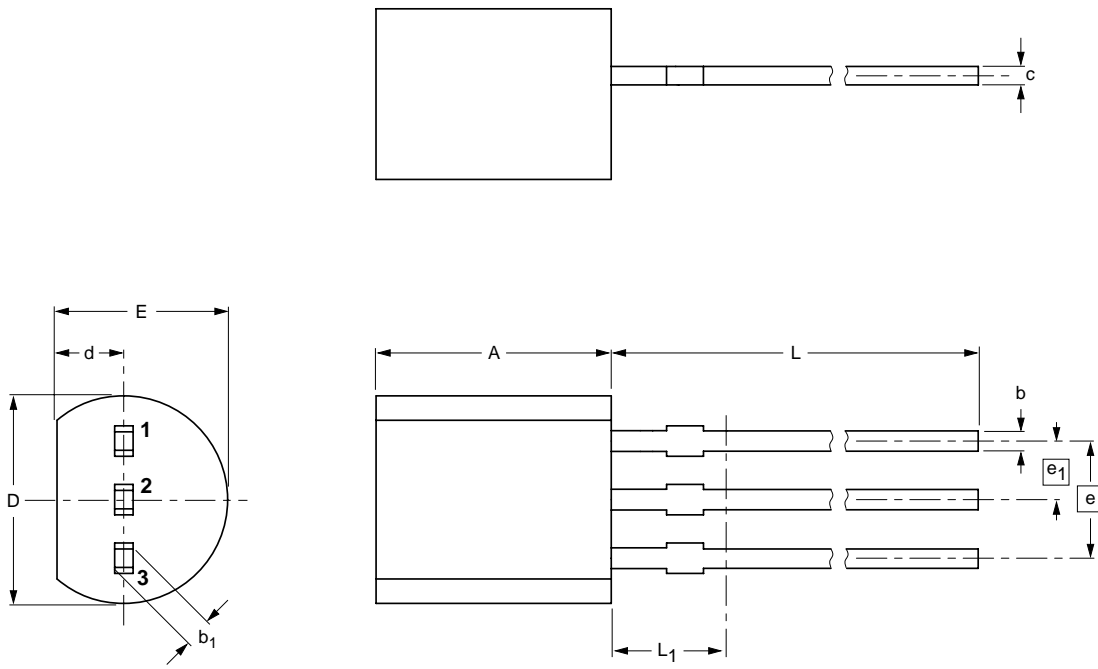

DIMENSIONS (mm are the original dimensions)

UNIT	A	b	b ₁	c	D	d	E	e	e ₁	L	L ₁ ⁽¹⁾ max.
mm	5.2 5.0	0.48 0.40	0.66 0.55	0.45 0.38	4.8 4.4	1.7 1.4	4.2 3.6	2.54	1.27	14.5 12.7	2.5

Note

1. Terminal dimensions within this zone are uncontrolled to allow for flow of plastic and terminal irregularities.

OUTLINE VERSION	REFERENCES			EUROPEAN PROJECTION	ISSUE DATE
	IEC	JEDEC	JEITA		
SOT54		TO-92	SC-43A		04-06-28 04-11-16

PNP resistor-equipped transistors;
R1 = 2.2 kΩ, R2 = 2.2 kΩ

PDTA123E series

Plastic surface-mounted package; 3 leads

SOT23

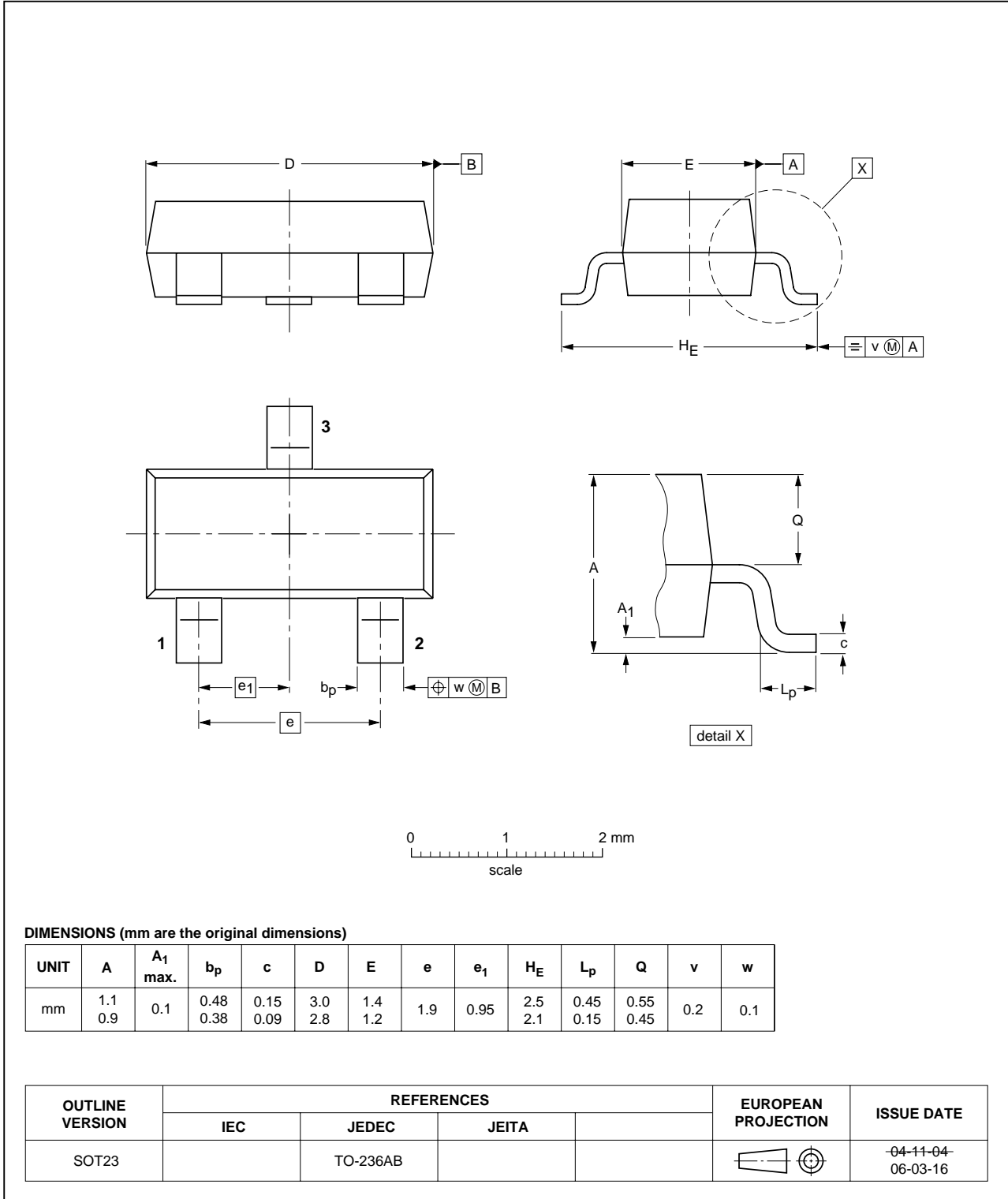

PNP resistor-equipped transistors;
R1 = 2.2 kΩ, R2 = 2.2 kΩ

PDTA123E series

Plastic surface-mounted package; 3 leads

SOT323

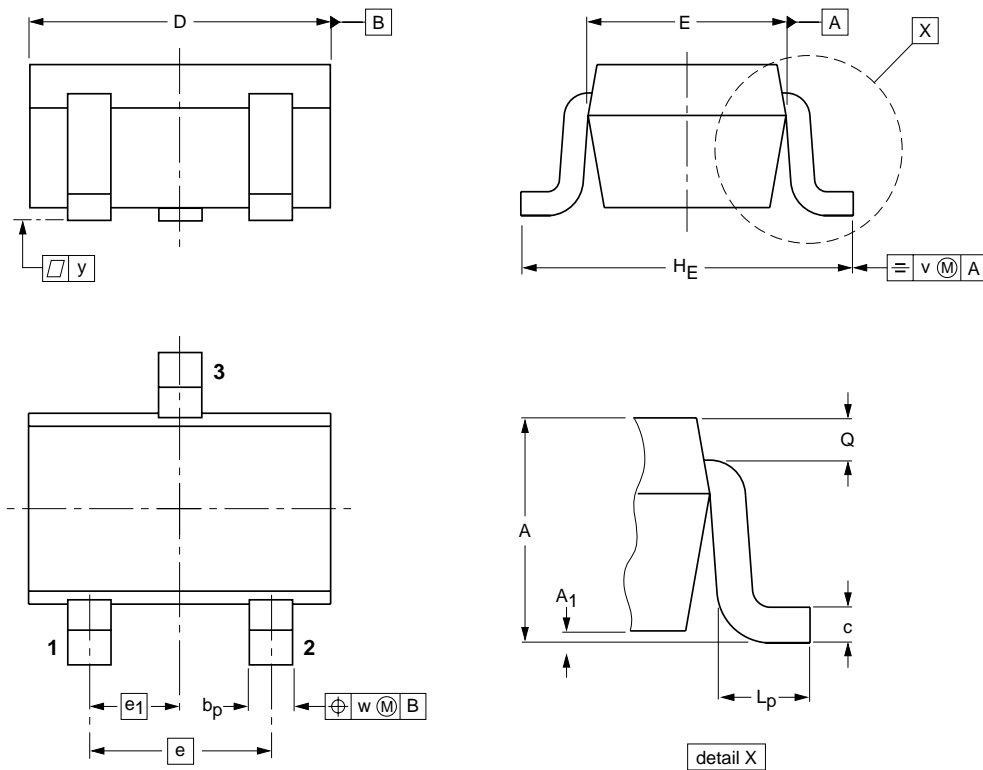

DIMENSIONS (mm are the original dimensions)

UNIT	A	A ₁ max	b _p	c	D	E	e	e ₁	H _E	L _p	Q	v	w
mm	1.1 0.8	0.1	0.4 0.3	0.25 0.10	2.2 1.8	1.35 1.15	1.3	0.65	2.2 2.0	0.45 0.15	0.23 0.13	0.2	0.2

OUTLINE VERSION	REFERENCES				EUROPEAN PROJECTION	ISSUE DATE
	IEC	JEDEC	JEITA			
SOT323			SC-70			04-11-04 06-03-16

PNP resistor-equipped transistors;
R1 = 2.2 kΩ, R2 = 2.2 kΩ

PDTA123E series

DATA SHEET STATUS

DOCUMENT STATUS ⁽¹⁾	PRODUCT STATUS ⁽²⁾	DEFINITION
Objective data sheet	Development	This document contains data from the objective specification for product development.
Preliminary data sheet	Qualification	This document contains data from the preliminary specification.
Product data sheet	Production	This document contains the product specification.

Notes

1. Please consult the most recently issued document before initiating or completing a design.
2. The product status of device(s) described in this document may have changed since this document was published and may differ in case of multiple devices. The latest product status information is available on the Internet at URL <http://www.nxp.com>.

DISCLAIMERS

General — Information in this document is believed to be accurate and reliable. However, NXP Semiconductors does not give any representations or warranties, expressed or implied, as to the accuracy or completeness of such information and shall have no liability for the consequences of use of such information.

Right to make changes — NXP Semiconductors reserves the right to make changes to information published in this document, including without limitation specifications and product descriptions, at any time and without notice. This document supersedes and replaces all information supplied prior to the publication hereof.

Suitability for use — NXP Semiconductors products are not designed, authorized or warranted to be suitable for use in medical, military, aircraft, space or life support equipment, nor in applications where failure or malfunction of an NXP Semiconductors product can reasonably be expected to result in personal injury, death or severe property or environmental damage. NXP Semiconductors accepts no liability for inclusion and/or use of NXP Semiconductors products in such equipment or applications and therefore such inclusion and/or use is at the customer's own risk.

Applications — Applications that are described herein for any of these products are for illustrative purposes only. NXP Semiconductors makes no representation or warranty that such applications will be suitable for the specified use without further testing or modification.

Limiting values — Stress above one or more limiting values (as defined in the Absolute Maximum Ratings System of IEC 60134) may cause permanent damage to the device. Limiting values are stress ratings only and

operation of the device at these or any other conditions above those given in the Characteristics sections of this document is not implied. Exposure to limiting values for extended periods may affect device reliability.

Terms and conditions of sale — NXP Semiconductors products are sold subject to the general terms and conditions of commercial sale, as published at <http://www.nxp.com/profile/terms>, including those pertaining to warranty, intellectual property rights infringement and limitation of liability, unless explicitly otherwise agreed to in writing by NXP Semiconductors. In case of any inconsistency or conflict between information in this document and such terms and conditions, the latter will prevail.

No offer to sell or license — Nothing in this document may be interpreted or construed as an offer to sell products that is open for acceptance or the grant, conveyance or implication of any license under any copyrights, patents or other industrial or intellectual property rights.

Export control — This document as well as the item(s) described herein may be subject to export control regulations. Export might require a prior authorization from national authorities.

Quick reference data — The Quick reference data is an extract of the product data given in the Limiting values and Characteristics sections of this document, and as such is not complete, exhaustive or legally binding.

NXP Semiconductors

Customer notification

This data sheet was changed to reflect the new company name NXP Semiconductors, including new legal definitions and disclaimers. No changes were made to the technical content, except for package outline drawings which were updated to the latest version.

Contact information

For additional information please visit: <http://www.nxp.com>

For sales offices addresses send e-mail to: salesaddresses@nxp.com

© NXP B.V. 2009

All rights are reserved. Reproduction in whole or in part is prohibited without the prior written consent of the copyright owner.

The information presented in this document does not form part of any quotation or contract, is believed to be accurate and reliable and may be changed without notice. No liability will be accepted by the publisher for any consequence of its use. Publication thereof does not convey nor imply any license under patent- or other industrial or intellectual property rights.

Printed in The Netherlands

R75/07/pp14



Date of release: 2004 Aug 02

Document order number: 9397 750 13649



Looking for pricing, stock, or lifecycle information?

Click below to explore more details on WIN SOURCE:

-  [View PDTA123ET,215 on WIN SOURCE](#)
-  [Nexperia USA Inc. Information](#)

Optimize Your Supply Chain with WIN SOURCE Solutions

-  Global Sourcing Solution
-  Obsolete Management
-  Cost Control Management
-  Shortage Management
-  Alternative Solution
-  Excess Inventory Management