



**THE DATASHEET OF  
DMJT9435-13**

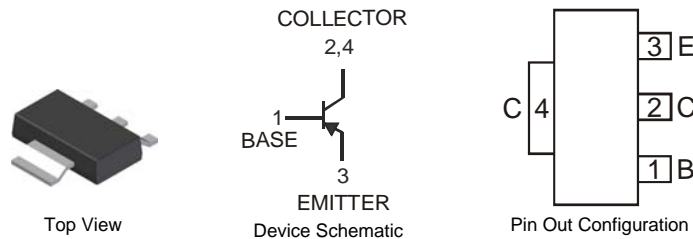


## Features

- Ideally Suited for Automated Assembly Processes
- Low Collector-Emitter Saturation Voltage
- Ideal for Medium Power Switching or Amplification Applications
- **Lead Free By Design/RoHS Compliant (Note 1)**
- **"Green" Device (Note 2)**

## Mechanical Data

- Case: SOT-223
- Case Material: Molded Plastic, "Green" Molding Compound. UL Flammability Classification Rating 94V-0
- Moisture Sensitivity: Level 1 per J-STD-020D
- Terminals: Finish — Matte Tin annealed over Copper leadframe (Lead Free Plating). Solderable per MIL-STD-202, Method 208
- Marking Information: See Page 4
- Ordering Information: See Page 4
- Weight: 0.115 grams (approximate)



## Maximum Ratings @ $T_A = 25^\circ\text{C}$ unless otherwise specified

Characteristic	Symbol	Value	Unit
Collector-Base Voltage	$V_{CBO}$	-45	V
Collector-Emitter Voltage	$V_{CEO}$	-30	V
Emitter-Base Voltage	$V_{EBO}$	-6	V
Peak Pulse Current	$I_{CM}$	-5	A
Continuous Collector Current	$I_C$	-3	A
Continuous Base Current	$I_B$	-1	A

## Thermal Characteristics

Characteristic	Symbol	Value	Unit
Power Dissipation (Note 3) @ $T_A = 25^\circ\text{C}$	$P_D$	1.2	W
Thermal Resistance, Junction to Ambient Air (Note 3) @ $T_A = 25^\circ\text{C}$	$R_{\theta JA}$	104	$^\circ\text{C/W}$
Power Dissipation (Note 4) @ $T_A = 25^\circ\text{C}$	$P_D$	2	W
Thermal Resistance, Junction to Ambient Air (Note 4) @ $T_A = 25^\circ\text{C}$	$R_{\theta JA}$	62.5	$^\circ\text{C/W}$
Power Dissipation @ $T_C = 25^\circ\text{C}$	$P_D$	3	W
Thermal Resistance, Junction to Case @ $T_C = 25^\circ\text{C}$	$R_{\theta JA}$	42	$^\circ\text{C/W}$
Operating and Storage Temperature Range	$T_J, T_{STG}$	-55 to +150	$^\circ\text{C}$

- Notes:
1. No purposefully added lead.
  2. Diodes Inc.'s "Green" policy can be found on our website at [http://www.diodes.com/products/lead\\_free/index.php](http://www.diodes.com/products/lead_free/index.php).
  3. Device mounted on FR-4 PCB with minimum recommended pad layout.
  4. Device mounted on FR-4 PCB with 1 inch<sup>2</sup> copper pad layout.

**Electrical Characteristics** @ $T_A = 25^\circ\text{C}$  unless otherwise specified

Characteristic	Symbol	Min	Typ	Max	Unit	Test Conditions
<b>OFF CHARACTERISTICS</b>						
Collector-Emitter Breakdown Voltage (Note 5)	$V_{(BR)CEO}$	-30	—	—	V	$I_C = -10\text{mA}$
Emitter-Base Breakdown Voltage	$V_{(BR)EBO}$	-6	—	—	V	$I_E = -50\mu\text{A}$
Collector-Base Cutoff Current	$I_{CER}$	—	—	-20	$\mu\text{A}$	$V_{CB} = -25\text{V}, R_{BE} = 200\Omega$
		—	—	-200	$\mu\text{A}$	$V_{CB} = -25\text{V}, R_{BE} = 200\Omega, T_A = 125^\circ\text{C}$
Emitter-Base Cutoff Current	$I_{EBO}$	—	—	-10	$\mu\text{A}$	$V_{EB} = -5\text{V}, I_C = 0$
<b>ON CHARACTERISTICS (Note 5)</b>						
DC Current Gain	$h_{FE}$	125	—	—	—	$V_{CE} = -1\text{V}, I_C = -0.8\text{A}$
		110	—	—	—	$V_{CE} = -1\text{V}, I_C = -1.2\text{A}$
		90	—	—	—	$V_{CE} = -1\text{V}, I_C = -3\text{A}$
Collector-Emitter Saturation Voltage	$V_{CE(SAT)}$	—	-100	-210	mV	$I_C = -0.8\text{A}, I_B = -20\text{mA}$
		—	—	-275	mV	$I_C = -1.2\text{A}, I_B = -20\text{mA}$
		—	-250	-550	mV	$I_C = -3\text{A}, I_B = -300\text{mA}$
Equivalent On-Resistance	$R_{CE(SAT)}$	—	83	183	$\text{m}\Omega$	$I_C = -3.0\text{A}, I_B = -300\text{mA}$
Base-Emitter Saturation Voltage	$V_{BE(SAT)}$	—	—	-1.25	V	$I_C = -3\text{A}, I_B = -300\text{mA}$
Base-Emitter Turn-on Voltage	$V_{BE(ON)}$	—	—	-1.1	V	$V_{CE} = -4\text{V}, I_C = -1.2\text{A}$
<b>SMALL SIGNAL CHARACTERISTICS</b>						
Transition Frequency	$f_T$	—	160	—	MHz	$V_{CE} = -10\text{V}, I_C = -100\text{mA}, f = 100\text{MHz}$
Output Capacitance	$C_{obo}$	—	45	150	pF	$V_{CB} = -10\text{V}, f = 1\text{MHz}$
Input Capacitance	$C_{ibo}$	—	140	—	pF	$V_{EB} = -8\text{V}, f = 1\text{MHz}$
<b>SWITCHING CHARACTERISTICS</b>						
Turn-On Time	$t_{on}$	—	200	—	ns	$V_{CC} = -15\text{V}, I_C = -1.2\text{A}, I_{B1} = -20\text{mA}$
Delay Time	$t_d$	—	90	—	ns	
Rise Time	$t_r$	—	110	—	ns	
Turn-Off Time	$t_{off}$	—	155	—	ns	$V_{CC} = -15\text{V}, I_C = -1.2\text{A}, I_{B1} = I_{B2} = -20\text{mA}$
Storage Time	$t_s$	—	100	—	ns	
Fall Time	$t_f$	—	55	—	ns	

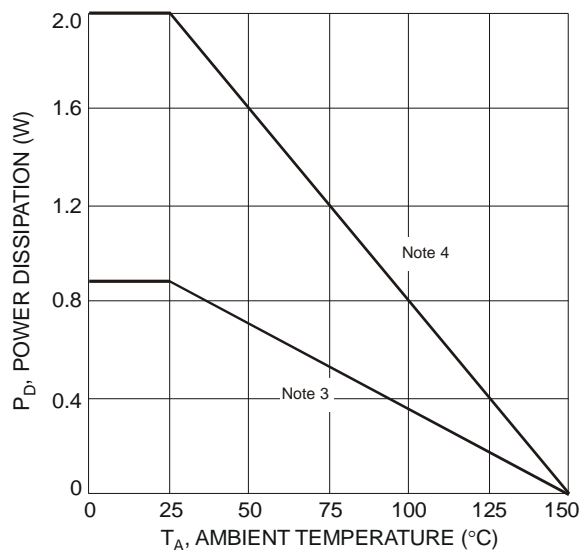
 Notes: 5. Measured under pulsed conditions. Pulse width =  $300\mu\text{s}$ . Duty cycle  $\leq 2\%$ .


Fig. 1 Power Dissipation vs. Ambient Temperature

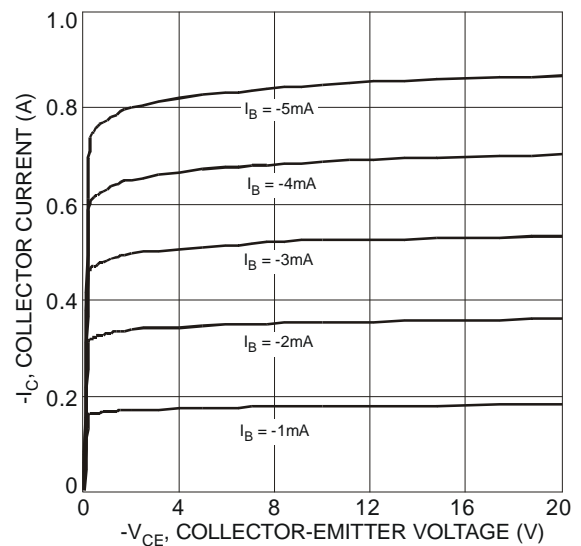


Fig. 2 Typical Collector Current vs. Collector-Emitter Voltage

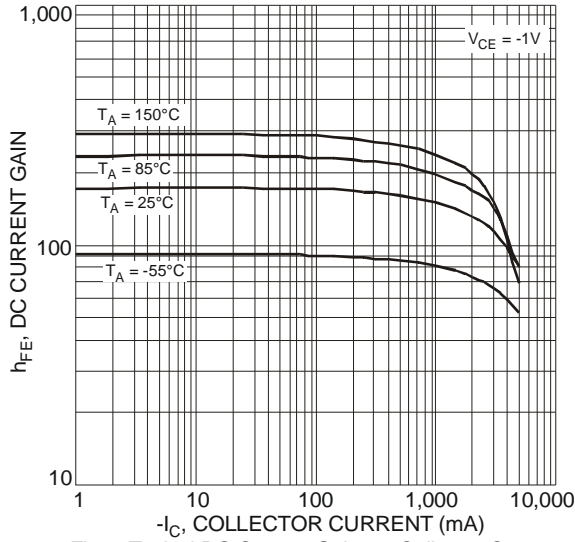


Fig. 3 Typical DC Current Gain vs. Collector Current

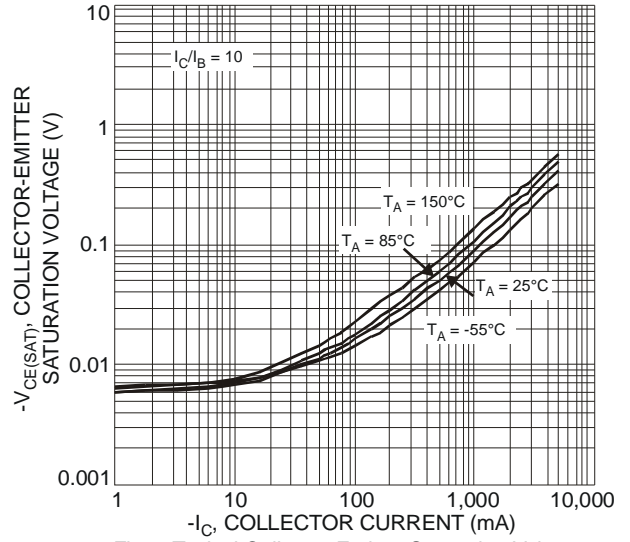


Fig. 4 Typical Collector-Emitter Saturation Voltage vs. Collector Current

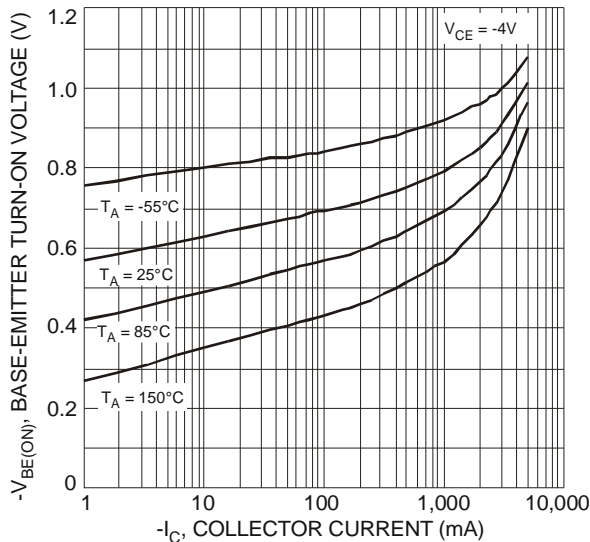


Fig. 5 Typical Base-Emitter Turn-On Voltage vs. Collector Current

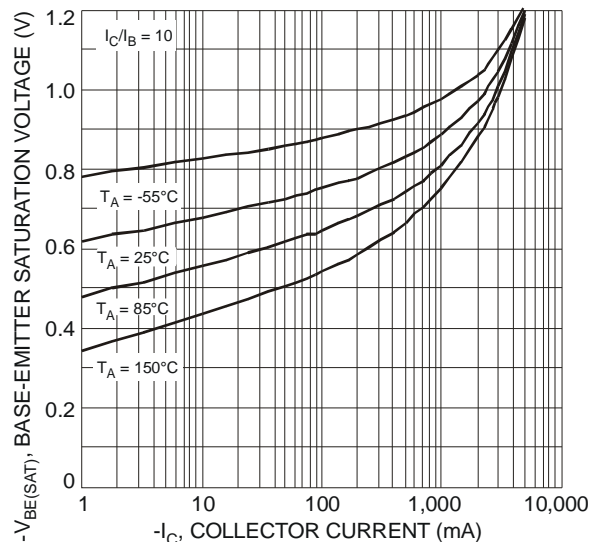


Fig. 6 Typical Base-Emitter Saturation Voltage vs. Collector Current

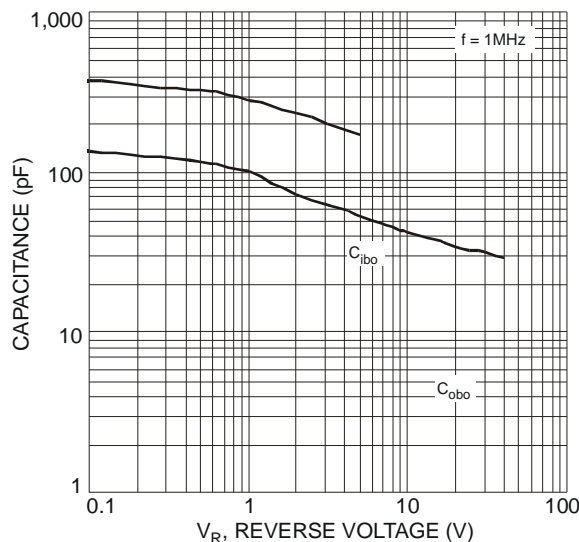


Fig. 7 Typical Capacitance Characteristics

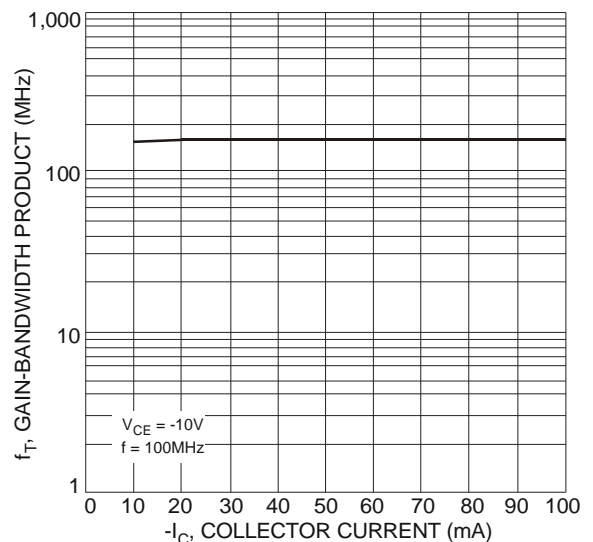
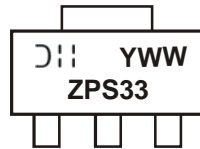


Fig. 8 Typical Gain-Bandwidth Product vs. Collector Current

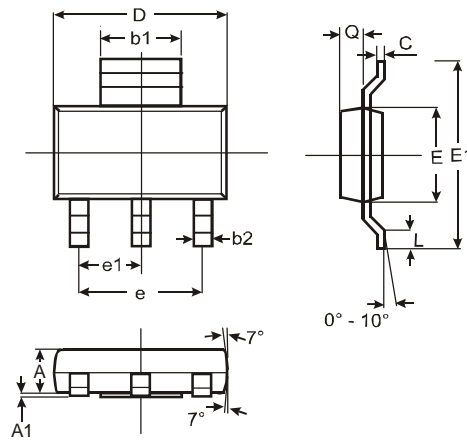
**Ordering Information** (Note 6)

Part Number	Case	Packaging
DMJT9435-13	SOT-223	2500/Tape & Reel

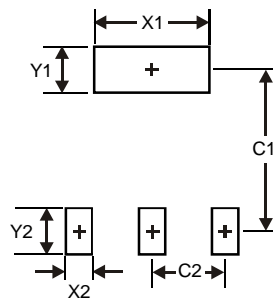
Notes: 6. For packaging details, go to our website at <http://www.diodes.com/datasheets/ap02007.pdf>.

**Marking Information**


ZPS33 = Product Type Marking Code  
 YWW = Date Code Marking  
 Y = Last digit of year (ex: 8 = 2008)  
 WW = Week code 01 - 52

**Package Outline Dimensions**


SOT-223			
Dim	Min	Max	Typ
A	1.55	1.65	1.60
A1	0.010	0.15	0.05
b1	2.90	3.10	3.00
b2	0.60	0.80	0.70
C	0.20	0.30	0.25
D	6.45	6.55	6.50
E	3.45	3.55	3.50
E1	6.90	7.10	7.00
e	—	—	4.60
e1	—	—	2.30
L	0.85	1.05	0.95
Q	0.84	0.94	0.89
All Dimensions in mm			

**Suggested Pad Layout**


Dimensions	Value (in mm)
X1	3.3
X2	1.2
Y1	1.6
Y2	1.6
C1	6.4
C2	2.3

**IMPORTANT NOTICE**

Diodes Incorporated and its subsidiaries reserve the right to make modifications, enhancements, improvements, corrections or other changes without further notice to any product herein. Diodes Incorporated does not assume any liability arising out of the application or use of any product described herein; neither does it convey any license under its patent rights, nor the rights of others. The user of products in such applications shall assume all risks of such use and will agree to hold Diodes Incorporated and all the companies whose products are represented on our website, harmless against all damages.

**LIFE SUPPORT**

Diodes Incorporated products are not authorized for use as critical components in life support devices or systems without the expressed written approval of the President of Diodes Incorporated.

NEW PRODUCT

## Looking for pricing, stock, or lifecycle information?

Click below to explore more details on WIN SOURCE:

 [View DMJT9435-13 on WIN SOURCE](#)

 [Diodes Incorporated](#) Information

## Optimize Your Supply Chain with WIN SOURCE Solutions

-  Global Sourcing Solution
-  Obsolete Management
-  Cost Control Management
-  Shortage Management
-  Alternative Solution
-  Excess Inventory Management