



**THE DATASHEET OF
2PC4081S,135**



Important notice

Dear Customer,

On 7 February 2017 the former NXP Standard Product business became a new company with the tradename **Nexperia**. Nexperia is an industry leading supplier of Discrete, Logic and PowerMOS semiconductors with its focus on the automotive, industrial, computing, consumer and wearable application markets

In data sheets and application notes which still contain NXP or Philips Semiconductors references, use the references to Nexperia, as shown below.

Instead of <http://www.nxp.com>, <http://www.philips.com/> or <http://www.semiconductors.philips.com/>, use <http://www.nexperia.com>

Instead of sales.addresses@www.nxp.com or sales.addresses@www.semiconductors.philips.com, use salesaddresses@nexperia.com (email)

Replace the copyright notice at the bottom of each page or elsewhere in the document, depending on the version, as shown below:

- © NXP N.V. (year). All rights reserved or © Koninklijke Philips Electronics N.V. (year). All rights reserved

Should be replaced with:

- © **Nexperia B.V. (year). All rights reserved.**

If you have any questions related to the data sheet, please contact our nearest sales office via e-mail or telephone (details via salesaddresses@nexperia.com). Thank you for your cooperation and understanding,

Kind regards,

Team Nexperia

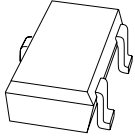

2PC4081

NPN general-purpose transistor

Rev. 06 — 17 November 2009

Product data sheet

1. Product profile

1.1 General description

NPN transistor in a SOT323 (SC-70) plastic package. The PNP complement is 2PA1576.

1.2 Features

- Low current (max. 150 mA)
- Low voltage (max. 50 V)

1.3 Applications

- General-purpose switching
- Small signal amplification

2. Pinning information

Table 1. Pinning

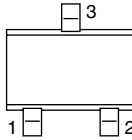
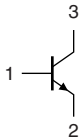
Pin	Description	Simplified outline	Symbol
1	base		
2	emitter		
3	collector		

sym021

3. Ordering information

Table 2. Ordering information

Type number	Package		Version
	Name	Description	
2PC4081Q	SC-70	plastic surface mounted package; 3 leads	SOT323
2PC4081R			
2PC4081S			

4. Marking

Table 3. Marking codes

Type number	Marking code ^[1]
2PC4081Q	Z*Q
2PC4081R	Z*R
2PC4081S	Z*S

[1] * = -: made in Hong Kong
* = t: made in Malaysia

5. Limiting values

Table 4. Limiting values

In accordance with the Absolute Maximum Rating System (IEC 60134).

Symbol	Parameter	Conditions	Min	Max	Unit
V_{CBO}	collector-base voltage	open emitter	-	60	V
V_{CEO}	collector-emitter voltage	open base	-	50	V
V_{EBO}	emitter-base voltage	open collector	-	7	V
I_C	collector current (DC)		-	150	mA
I_{CM}	peak collector current		-	200	mA
I_{BM}	peak base current		-	200	mA
P_{tot}	total power dissipation	$T_{amb} \leq 25\text{ °C}$	^[1] -	200	mW
T_{stg}	storage temperature		-65	+150	°C
T_j	junction temperature		-	150	°C
T_{amb}	ambient temperature		-65	+150	°C

[1] Transistor mounted on an FR4 printed-circuit board, single-sided copper, tin-plated and standard footprint.

6. Thermal characteristics

Table 5. Thermal characteristics

Symbol	Parameter	Conditions	Min	Typ	Max	Unit
$R_{th(j-a)}$	thermal resistance from junction to ambient		^[1] -	-	625	K/W

[1] Transistor mounted on an FR4 printed-circuit board, single-sided copper, tin-plated and standard footprint.

7. Characteristics

Table 6. Characteristics

$T_{amb} = 25\text{ °C}$ unless otherwise specified.

Symbol	Parameter	Conditions	Min	Typ	Max	Unit				
I_{CBO}	collector-base cut-off current	$I_E = 0\text{ A}; V_{CB} = 30\text{ V}$	-	-	100	nA				
		$I_E = 0\text{ A}; V_{CB} = 30\text{ V}; T_j = 150\text{ °C}$	-	-	5	μA				
I_{EBO}	emitter-base cut-off current	$I_C = 0\text{ A}; V_{EB} = 4\text{ V}$	-	-	100	nA				
h_{FE}	DC current gain	$I_C = 1\text{ mA}; V_{CE} = 6\text{ V}$								
							2PC4081Q	120	-	270
							2PC4081R	180	-	390
							2PC4081S	270	-	560
V_{CEsat}	collector-emitter saturation voltage	$I_C = 50\text{ mA}; I_B = 5\text{ mA}$	[1]	-	400	mV				
C_c	collector capacitance	$I_E = i_e = 0\text{ A}; V_{CB} = 12\text{ V}; f = 1\text{ MHz}$	-	2	3.5	pF				
f_T	transition frequency	$I_C = 2\text{ mA}; V_{CE} = 12\text{ V}; f = 100\text{ MHz}$	100	-	-	MHz				

[1] Pulse test: $t_p \leq 300\text{ }\mu\text{s}; \delta \leq 0.02$.

8. Package outline

Plastic surface-mounted package; 3 leads

SOT323

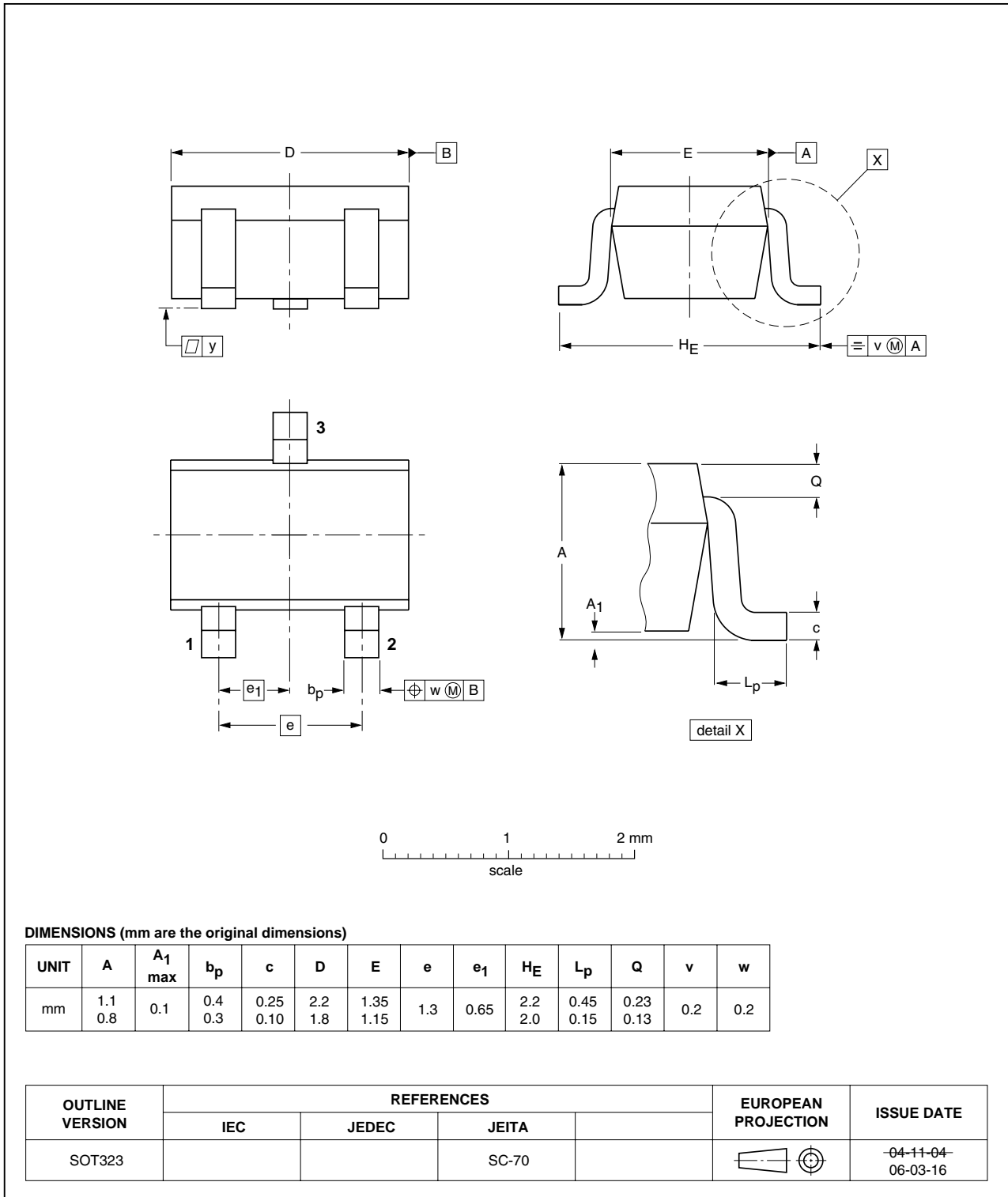

Fig 1. Package outline SOT323 (SC-70)

9. Revision history

Table 7. Revision history

Document ID	Release date	Data sheet status	Change notice	Supersedes
2PC4081_6	20091117	Product data sheet	-	2PC4081_5
Modifications:		<ul style="list-style-type: none">This data sheet was changed to reflect the new company name NXP Semiconductors, including new legal definitions and disclaimers. No changes were made to the technical content.Figure 1 "Package outline SOT323 (SC-70)": updated		
2PC4081_5	20041125	Product data sheet	-	2PC4081_4
2PC4081_4	19990408	Product specification	-	2PC4081_3
2PC4081_3	19970704	Product specification	-	2PC4081_2
2PC4081_2	19931213	n.a.	-	n.a.

10. Legal information

10.1 Data sheet status

Document status ^{[1][2]}	Product status ^[3]	Definition
Objective [short] data sheet	Development	This document contains data from the objective specification for product development.
Preliminary [short] data sheet	Qualification	This document contains data from the preliminary specification.
Product [short] data sheet	Production	This document contains the product specification.

[1] Please consult the most recently issued document before initiating or completing a design.

[2] The term 'short data sheet' is explained in section "Definitions".

[3] The product status of device(s) described in this document may have changed since this document was published and may differ in case of multiple devices. The latest product status information is available on the Internet at URL <http://www.nxp.com>.

10.2 Definitions

Draft — The document is a draft version only. The content is still under internal review and subject to formal approval, which may result in modifications or additions. NXP Semiconductors does not give any representations or warranties as to the accuracy or completeness of information included herein and shall have no liability for the consequences of use of such information.

Short data sheet — A short data sheet is an extract from a full data sheet with the same product type number(s) and title. A short data sheet is intended for quick reference only and should not be relied upon to contain detailed and full information. For detailed and full information see the relevant full data sheet, which is available on request via the local NXP Semiconductors sales office. In case of any inconsistency or conflict with the short data sheet, the full data sheet shall prevail.

10.3 Disclaimers

General — Information in this document is believed to be accurate and reliable. However, NXP Semiconductors does not give any representations or warranties, expressed or implied, as to the accuracy or completeness of such information and shall have no liability for the consequences of use of such information.

Right to make changes — NXP Semiconductors reserves the right to make changes to information published in this document, including without limitation specifications and product descriptions, at any time and without notice. This document supersedes and replaces all information supplied prior to the publication hereof.

Suitability for use — NXP Semiconductors products are not designed, authorized or warranted to be suitable for use in medical, military, aircraft, space or life support equipment, nor in applications where failure or malfunction of an NXP Semiconductors product can reasonably be expected to result in personal injury, death or severe property or environmental

damage. NXP Semiconductors accepts no liability for inclusion and/or use of NXP Semiconductors products in such equipment or applications and therefore such inclusion and/or use is at the customer's own risk.

Applications — Applications that are described herein for any of these products are for illustrative purposes only. NXP Semiconductors makes no representation or warranty that such applications will be suitable for the specified use without further testing or modification.

Limiting values — Stress above one or more limiting values (as defined in the Absolute Maximum Ratings System of IEC 60134) may cause permanent damage to the device. Limiting values are stress ratings only and operation of the device at these or any other conditions above those given in the Characteristics sections of this document is not implied. Exposure to limiting values for extended periods may affect device reliability.

Terms and conditions of sale — NXP Semiconductors products are sold subject to the general terms and conditions of commercial sale, as published at <http://www.nxp.com/profile/terms>, including those pertaining to warranty, intellectual property rights infringement and limitation of liability, unless explicitly otherwise agreed to in writing by NXP Semiconductors. In case of any inconsistency or conflict between information in this document and such terms and conditions, the latter will prevail.

No offer to sell or license — Nothing in this document may be interpreted or construed as an offer to sell products that is open for acceptance or the grant, conveyance or implication of any license under any copyrights, patents or other industrial or intellectual property rights.

Export control — This document as well as the item(s) described herein may be subject to export control regulations. Export might require a prior authorization from national authorities.

Quick reference data — The Quick reference data is an extract of the product data given in the Limiting values and Characteristics sections of this document, and as such is not complete, exhaustive or legally binding.

10.4 Trademarks

Notice: All referenced brands, product names, service names and trademarks are the property of their respective owners.

11. Contact information

For more information, please visit: <http://www.nxp.com>

For sales office addresses, please send an email to: salesaddresses@nxp.com

12. Contents

1	Product profile	1
1.1	General description	1
1.2	Features	1
1.3	Applications	1
2	Pinning information	1
3	Ordering information	1
4	Marking	2
5	Limiting values	2
6	Thermal characteristics	2
7	Characteristics	3
8	Package outline	4
9	Revision history	5
10	Legal information	6
10.1	Data sheet status	6
10.2	Definitions	6
10.3	Disclaimers	6
10.4	Trademarks	6
11	Contact information	6
12	Contents	7

Please be aware that important notices concerning this document and the product(s) described herein, have been included in section 'Legal information'.



© NXP B.V. 2009.

All rights reserved.

For more information, please visit: <http://www.nxp.com>



For sales office addresses, please send an email to: salesaddresses@nxp.com

Date of release: 17 November 2009



Document identifier: 2PC4081_6

Looking for pricing, stock, or lifecycle information?

Click below to explore more details on WIN SOURCE:

-  [View 2PC4081S,135 on WIN SOURCE](#)
-  [Nexperia USA Inc. Information](#)

Optimize Your Supply Chain with WIN SOURCE Solutions

-  Global Sourcing Solution
-  Obsolete Management
-  Cost Control Management
-  Shortage Management
-  Alternative Solution
-  Excess Inventory Management