



**THE DATASHEET OF  
B550C-13-F**



## Product Summary

B520C/B530C/B540C

V <sub>RRM</sub> (V)	I <sub>o</sub> (A)	V <sub>F Max</sub> (V)	I <sub>R Max</sub> (mA)
20/30/40	5.0	0.55	0.5

B550C/B560C

V <sub>RRM</sub> (V)	I <sub>o</sub> (A)	V <sub>F Max</sub> (V)	I <sub>R Max</sub> (mA)
50/60	5.0	0.70	0.5

## Description and Applications

This Schottky barrier rectifier is designed to meet the general requirements of commercial applications. It is ideally suited for use as:

- Polarity protection diodes
- Re-circulating diodes
- Switching diodes

## Features and Benefits

- Guard Ring Die Construction for Transient Protection
- Ideally Suited for Automated Assembly
- Low Power Loss, High Efficiency
- For Use in Low-Voltage, High-Frequency Inverters, Free Wheeling, and Polarity Protection Applications
- **Lead-Free Finish; RoHS Compliant (Notes 1 & 2)**
- **Halogen and Antimony Free. "Green" Device (Notes 3)**
- **This part is qualified to JEDEC standards (as references in AEC-Q) for High Reliability.**  
<https://www.diodes.com/quality/product-definitions/>
- **An automotive-compliant part is available under separate datasheet ([B520CQ-B560CQ](#))**

## Mechanical Data

- Package: SMC
- Package Material: Molded Plastic. UL Flammability Classification Rating 94V-0
- Moisture Sensitivity: Level 1 per J-STD-020
- Terminals: Lead Free Plating (Matte Tin Finish). Solderable per MIL-STD-202, Method 208 Ⓔ
- Polarity: Cathode Band or Cathode Notch
- Weight: 0.21 grams (Approximate)

SMC



Top View

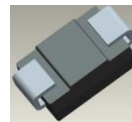

Bottom View

## Ordering Information (Note 4)

Part Number	Package	Packing	
		Qty.	Carrier
B5xxC-13-F	SMC	3,000	Tape & Reel

\* xx = Device type, e.g., B520C-13-F (SMC package).

- Notes:
1. EU Directive 2002/95/EC (RoHS), 2011/65/EU (RoHS 2) & 2015/863/EU (RoHS 3) compliant. All applicable RoHS exemptions applied.
  2. See <https://www.diodes.com/quality/lead-free/> for more information about Diodes Incorporated's definitions of Halogen- and Antimony-free, "Green" and Lead-free.
  3. Halogen- and Antimony-free "Green" products are defined as those which contain <900ppm bromine, <900ppm chlorine (<1500ppm total Br + Cl) and <1000ppm antimony compounds.
  4. For packaging details, go to our website at <https://www.diodes.com/design/support/packaging/diodes-packaging/>.

## Marking Information

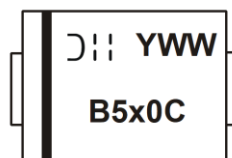

B5x0C = Product Type Marking Code, ex: B540C (SMC Package)

3|| = Manufacturer's Code Marking

YWW = Date Code Marking

Y = Last Digit of Year (ex: 3 for 2023)

WW = Week Code (01 to 53)

x = 2, 3, 4, 5 or 6, e.g., x = 4 for B540C

**Maximum Ratings** (@T<sub>A</sub> = +25°C, unless otherwise specified.)

Single phase, half wave, 60Hz, resistive or inductive load.  
For capacitive load, derate current by 20%.

Characteristic	Symbol	B520C	B530C	B540C	B550C	B560C	Unit
Peak Repetitive Reverse Voltage Working Peak Reverse Voltage DC Blocking Voltage	V <sub>RRM</sub> V <sub>RWM</sub> V <sub>R</sub>	20	30	40	50	60	V
RMS Reverse Voltage	V <sub>R(RMS)</sub>	14	21	28	35	42	V
Average Rectified Output Current	I <sub>O</sub>	5.0					A
Non-Repetitive Peak Forward Surge Current, 8.3ms Single Half Sine Wave Superimposed on Rated Load	I <sub>FSM</sub>	100					A

**Thermal Characteristics**

Characteristic	Symbol	Value	Unit
Thermal Resistance, Junction to Terminal	R <sub>θJT</sub>	10	°C/W
Thermal Resistance, Junction to Ambient (Note 5)	R <sub>θJA</sub>	50	°C/W
Operating Temperature Range	T <sub>J</sub>	-55 to +150	°C
Storage Temperature Range	T <sub>STG</sub>	-55 to +150	°C

**Electrical Characteristics** (@T<sub>A</sub> = +25°C, unless otherwise specified.)

Characteristic	Symbol	Min	Typ	Max	Unit	Test Condition
Forward Voltage Drop	V <sub>F</sub>	—	0.475	0.55	V	I <sub>F</sub> = 5.0A, T <sub>A</sub> = +25°C
		—	0.575	0.70		
Leakage Current (Note 6)	I <sub>R</sub>	—	—	0.5 20	mA	@ Rated V <sub>R</sub> , T <sub>A</sub> = +25°C @ Rated V <sub>R</sub> , T <sub>A</sub> = +100°C
Total Capacitance	C <sub>T</sub>	—	—	300	pF	V <sub>R</sub> = 4V, f = 1MHz

Notes: 5. Thermal Resistance: Junction to ambient, unit mounted on PC board with 8.0 mm<sup>2</sup> (0.033mm thick) copper pads as heatsink.  
6. Short duration pulse test used to minimize self-heating effect.

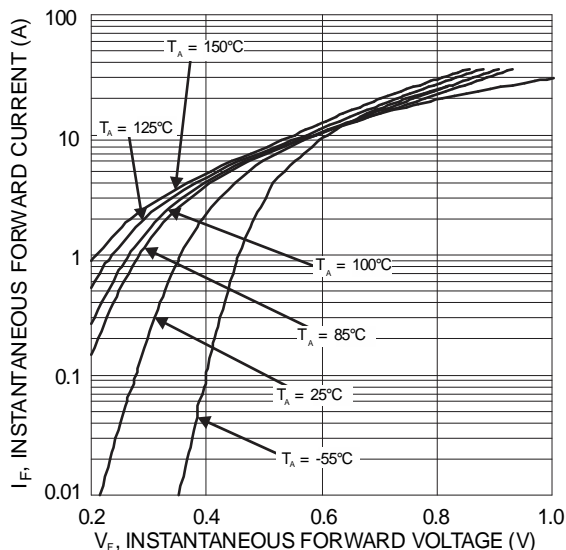

Figure 1 Typical Forward Characteristics (B520C - B540C)

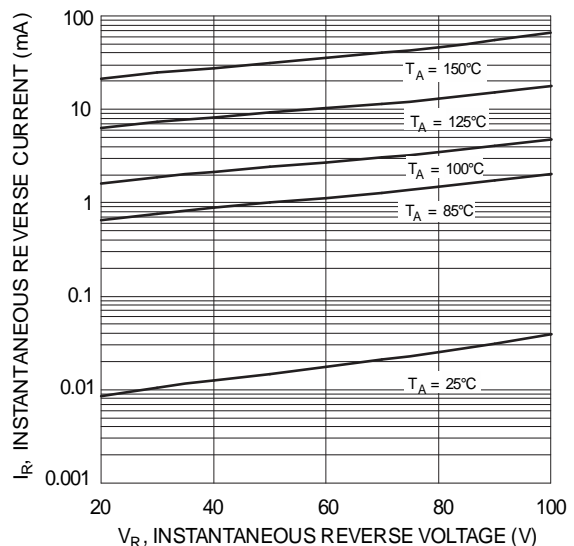
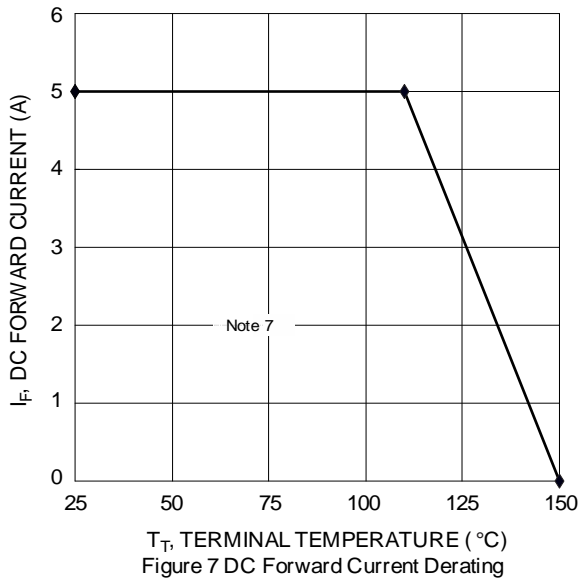
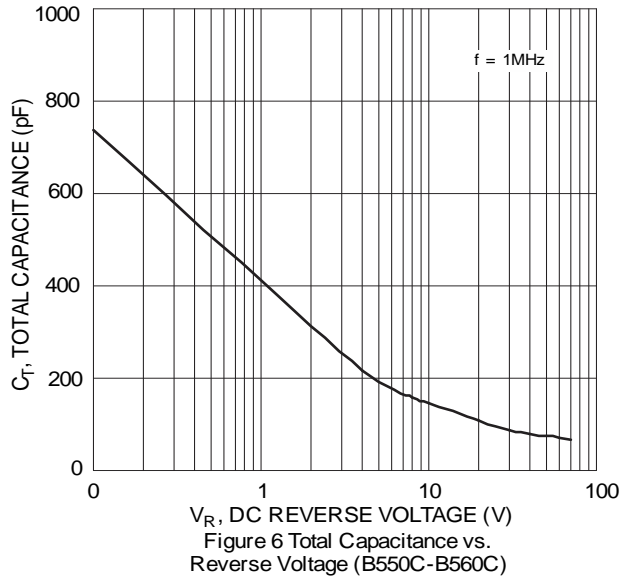
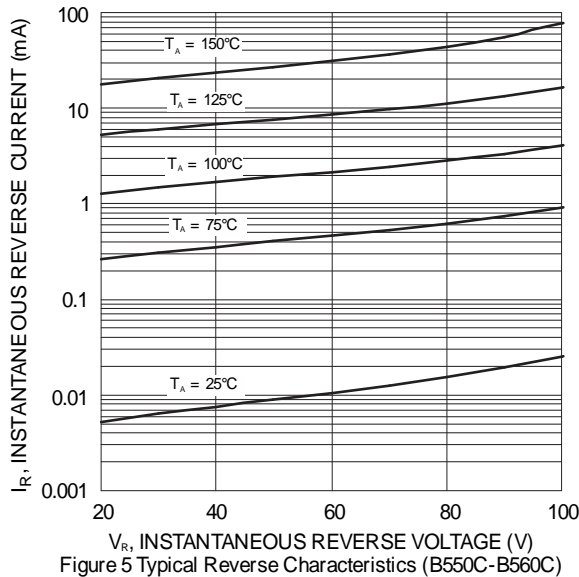
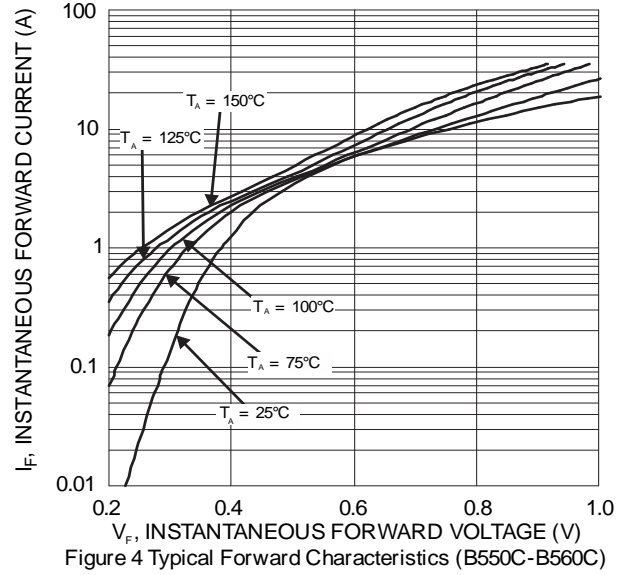
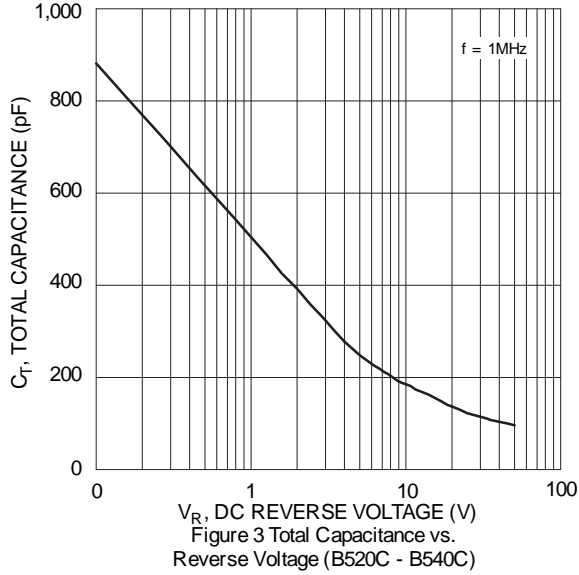

Figure 2 Typical Reverse Characteristics (B520C - B540C)



Note: 7. Device mounted on FR-4 substrate, 1" x 1", 2oz, single-sided PC boards with 0.56" x 0.73" copper pad.

## Package Outline Dimensions

Please see <http://www.diodes.com/package-outlines.html> for the latest version.

### SMC

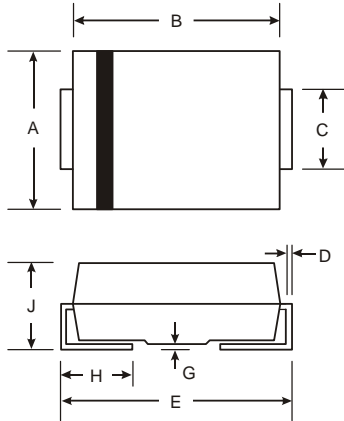

SMC		
Dim	Min	Max
A	5.59	6.22
B	6.60	7.11
C	2.75	3.18
D	0.15	0.31
E	7.75	8.13
G	0.10	0.20
H	0.76	1.52
J	2.00	2.50
All Dimensions in mm		

## Suggested Pad Layout

Please see <http://www.diodes.com/package-outlines.html> for the latest version.

### SMC

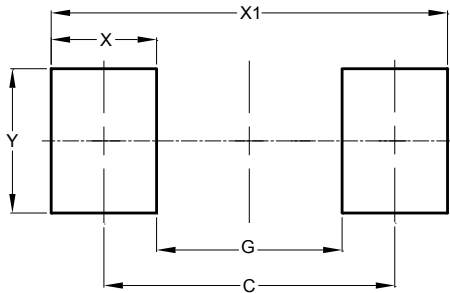

Dimensions	Value (in mm)
C	6.90
G	4.40
X	2.50
X1	9.40
Y	3.30

**IMPORTANT NOTICE**

1. DIODES INCORPORATED (Diodes) AND ITS SUBSIDIARIES MAKE NO WARRANTY OF ANY KIND, EXPRESS OR IMPLIED, WITH REGARDS TO ANY INFORMATION CONTAINED IN THIS DOCUMENT, INCLUDING, BUT NOT LIMITED TO, THE IMPLIED WARRANTIES OF MERCHANTABILITY, FITNESS FOR A PARTICULAR PURPOSE OR NON-INFRINGEMENT OF THIRD PARTY INTELLECTUAL PROPERTY RIGHTS (AND THEIR EQUIVALENTS UNDER THE LAWS OF ANY JURISDICTION).
2. The Information contained herein is for informational purpose only and is provided only to illustrate the operation of Diodes' products described herein and application examples. Diodes does not assume any liability arising out of the application or use of this document or any product described herein. This document is intended for skilled and technically trained engineering customers and users who design with Diodes' products. Diodes' products may be used to facilitate safety-related applications; however, in all instances customers and users are responsible for (a) selecting the appropriate Diodes products for their applications, (b) evaluating the suitability of Diodes' products for their intended applications, (c) ensuring their applications, which incorporate Diodes' products, comply the applicable legal and regulatory requirements as well as safety and functional-safety related standards, and (d) ensuring they design with appropriate safeguards (including testing, validation, quality control techniques, redundancy, malfunction prevention, and appropriate treatment for aging degradation) to minimize the risks associated with their applications.
3. Diodes assumes no liability for any application-related information, support, assistance or feedback that may be provided by Diodes from time to time. Any customer or user of this document or products described herein will assume all risks and liabilities associated with such use, and will hold Diodes and all companies whose products are represented herein or on Diodes' websites, harmless against all damages and liabilities.
4. Products described herein may be covered by one or more United States, international or foreign patents and pending patent applications. Product names and markings noted herein may also be covered by one or more United States, international or foreign trademarks and trademark applications. Diodes does not convey any license under any of its intellectual property rights or the rights of any third parties (including third parties whose products and services may be described in this document or on Diodes' website) under this document.
5. Diodes' products are provided subject to Diodes' Standard Terms and Conditions of Sale (<https://www.diodes.com/about/company/terms-and-conditions/terms-and-conditions-of-sales/>) or other applicable terms. This document does not alter or expand the applicable warranties provided by Diodes. Diodes does not warrant or accept any liability whatsoever in respect of any products purchased through unauthorized sales channel.
6. Diodes' products and technology may not be used for or incorporated into any products or systems whose manufacture, use or sale is prohibited under any applicable laws and regulations. Should customers or users use Diodes' products in contravention of any applicable laws or regulations, or for any unintended or unauthorized application, customers and users will (a) be solely responsible for any damages, losses or penalties arising in connection therewith or as a result thereof, and (b) indemnify and hold Diodes and its representatives and agents harmless against any and all claims, damages, expenses, and attorney fees arising out of, directly or indirectly, any claim relating to any noncompliance with the applicable laws and regulations, as well as any unintended or unauthorized application.
7. While efforts have been made to ensure the information contained in this document is accurate, complete and current, it may contain technical inaccuracies, omissions and typographical errors. Diodes does not warrant that information contained in this document is error-free and Diodes is under no obligation to update or otherwise correct this information. Notwithstanding the foregoing, Diodes reserves the right to make modifications, enhancements, improvements, corrections or other changes without further notice to this document and any product described herein. This document is written in English but may be translated into multiple languages for reference. Only the English version of this document is the final and determinative format released by Diodes.
8. Any unauthorized copying, modification, distribution, transmission, display or other use of this document (or any portion hereof) is prohibited. Diodes assumes no responsibility for any losses incurred by the customers or users or any third parties arising from any such unauthorized use.
9. This Notice may be periodically updated with the most recent version available at <https://www.diodes.com/about/company/terms-and-conditions/important-notice>

The Diodes logo is a registered trademark of Diodes Incorporated in the United States and other countries.  
All other trademarks are the property of their respective owners.  
© 2023 Diodes Incorporated. All Rights Reserved.

**www.diodes.com**

## Looking for pricing, stock, or lifecycle information?

Click below to explore more details on WIN SOURCE:

- [View B550C-13-F on WIN SOURCE](#)
- [Diodes Incorporated Information](#)

## Optimize Your Supply Chain with WIN SOURCE Solutions

- ✓ Global Sourcing Solution
- ✓ Obsolete Management
- ✓ Cost Control Management
- ✓ Shortage Management
- ✓ Alternative Solution
- ✓ Excess Inventory Management