



THE DATASHEET OF SSD2007ATF



FEATURES

- ❑ Extremely Lower $R_{DS(ON)}$
- ❑ Improved Inductive Ruggedness
- ❑ Fast Switching Times
- ❑ Rugged Polysilicon Gate Cell Structure
- ❑ Low Input Capacitance
- ❑ Extended Safe Operating Area
- ❑ Improved High Temperature Reliability
- ❑ Surface Mounting Package : **8SOP**

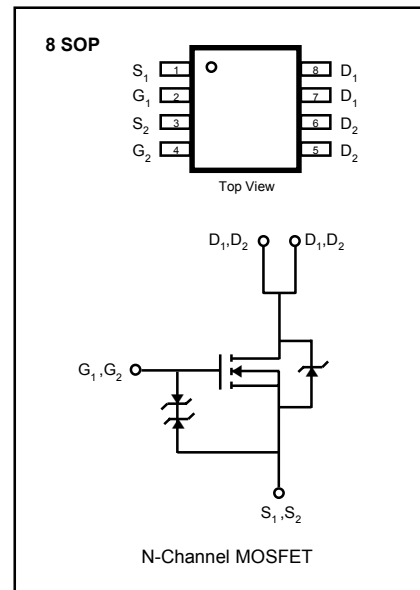

Absolute Maximum Ratings

Symbol	Characteristic	Value	Units
V_{DSS}	Drain-to-Source Voltage(1)	50	V
V_{DGR}	Drain-Gate Voltage($R_{GS}=1.0M\Omega$)(1)	50	V
V_{GS}	Gate-to-Source Voltage	± 20	V
I_D	Continuous Drain Current $T_A=25^\circ C$	2.0	A
I_D	Continuous Drain Current $T_A=100^\circ C$	1.6	A
I_{DM}	Drain Current-Pulsed (2)	8.0	V
P_D	Total Power Dissipation $T_A=25^\circ C$ $T_A=70^\circ C$	2.0	W
		1.3	
T_J, T_{STG}	Operating and Storage Junction Temperature Range	- 55 to +150	$^\circ C$
T_L	Maximum Lead Temp. for Soldering Purposes, 1/16" from case for 5 seconds	300	

Notes ;

(1) $T_J=25^\circ C$ to $150^\circ C$

(2) Repetitive Rating : Pulse Width Limited by Max. Junction Temperature

Electrical Characteristics ($T_A=25^\circ\text{C}$ unless otherwise specified)

Symbol	Characteristic	Min.	Typ.	Max.	Units	Test Condition
BV_{DSS}	Drain-Source Breakdown Voltage	50	--	--	V	$V_{GS}=0V, I_D=250\mu A$
$V_{GS(th)}$	Gate Threshold Voltage	2.0	--	4.0	V	$V_{DS}=V_{GS}, I_D=250\mu A$
I_{GSS}	Gate-Source Leakage, Forward	--	--	1.0	μA	$V_{GS}=20V$
	Gate-Source Leakage, Reverse	--	--	-1.0	μA	$V_{GS}=-20V$
I_{DSS}	Drain-to-Source Leakage Current	--	--	2	μA	$V_{DS}=50V$
		--	--	25		$V_{DS}=40V, T_J=55^\circ\text{C}$
I_{DON}	On-State Drain-Source Current(2)	8.0	--	--	A	$V_{GS}=10V, V_{DS}=5V$
$R_{DS(on)}$	Static Drain-Source			0.3	Ω	$V_{GS}=10V, I_D=1.5A$
	On-State Resistance(2)			0.5		$V_{GS}=5.0V, I_D=0.6A$
g_{fs}	Forward Transconductance	--	2.5	--	S	$V_{DS} \geq 15V, I_D=2.0A$
$t_{d(on)}$	Turn-On Delay Time	--	--	40	ns	$V_{DD}=30V, I_D=0.6A,$ $Z_0=6.0\Omega,$
t_r	Rise Time	--	--	70		
$t_{d(off)}$	Turn-Off Delay Time	--	--	100		
t_f	Fall Time	--	--	70		
Q_g	Total Gate Charge	--	--	15	nC	$V_{DS}=25V, V_{GS}=10V,$ $I_D=1.3A$
Q_{gs}	Gate-Source Charge	--	1.0	--		
Q_{gd}	Gate-Drain ("Miller") Charge	--	2.0	--		

Thermal Resistance

Symbol	Characteristic	Typ.	Max.	Units
$R_{\theta JA}$	Junction-to-Ambient	--	62.5	$^\circ\text{C/W}$

Notes ;

- $T_J=25^\circ\text{C}$ to 150°C
- Pulse Test : Pulse Width $\leq 300\mu\text{s}$, Duty Cycle $\leq 2\%$

Source-Drain Diode Ratings and Characteristics

Symbol	Characteristic	Min.	Typ.	Max.	Units	Test Condition
I_S	Continuous Source Current (Body Diode)	--	--	1.8	A	Modified MOSFET Symbol Showing the Integral Reverse P-N Junction Rectifier 
V_{SD}	Diode Forward Voltage(2)	--	--	1.2	V	$T_J=25^\circ\text{C}, I_S=1.25A, V_{GS}=0V$
t_{rr}	Reverse Recovery Time	--	--	100	ns	$T_J=25^\circ\text{C}, I_F=2.5A, di_F/dt=100A/\mu\text{s}$

Fig 1. Output Characteristics

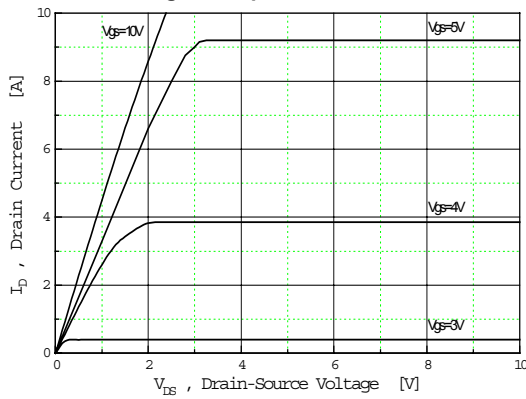

Fig 2. Transfer Characteristics

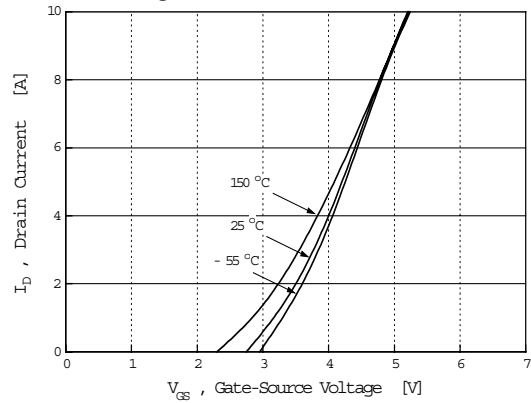

Fig 3. On-Resistance vs. Drain Current

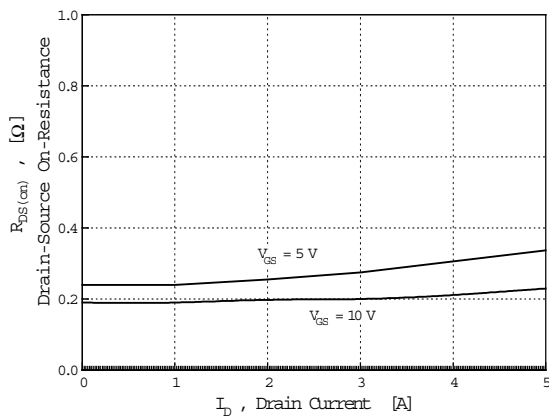

Fig 4. Capacitance vs. Drain-Source Voltage

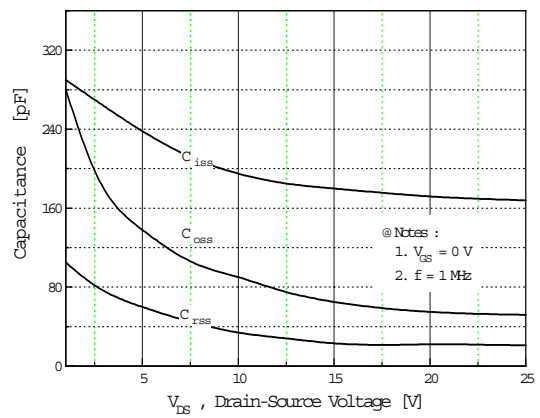

Fig 5. Breakdown Voltage vs. Temperature

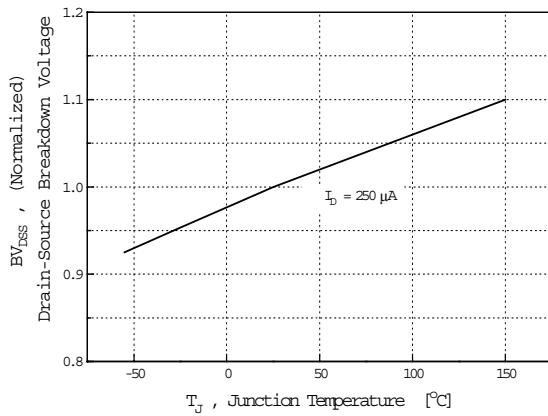

Fig 6. Normalized On-Resistance vs. Temperature

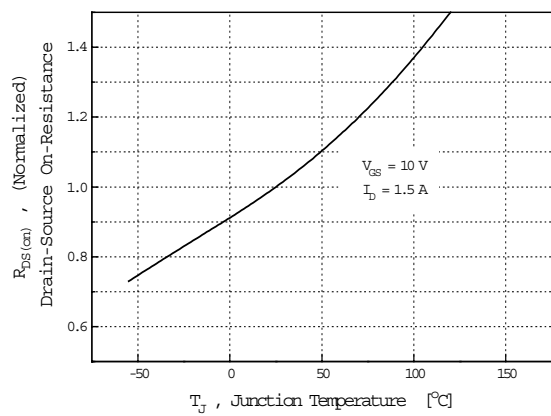

Fig 7. Normalized Effective Transient Thermal Impedance, Junction-to-Ambient

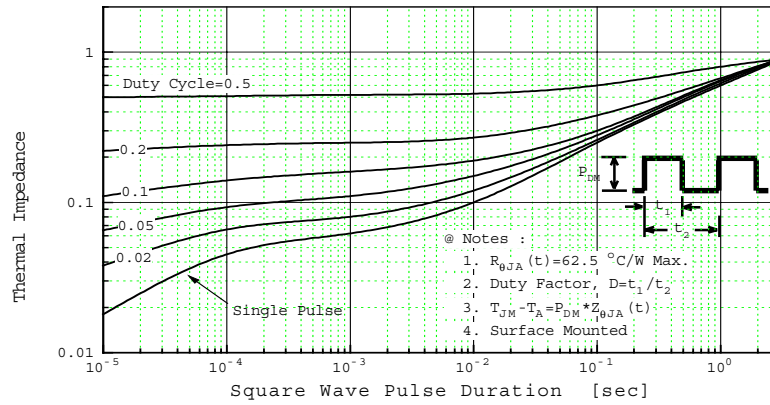

Fig 8. Source-Drain Diode Forward Voltage

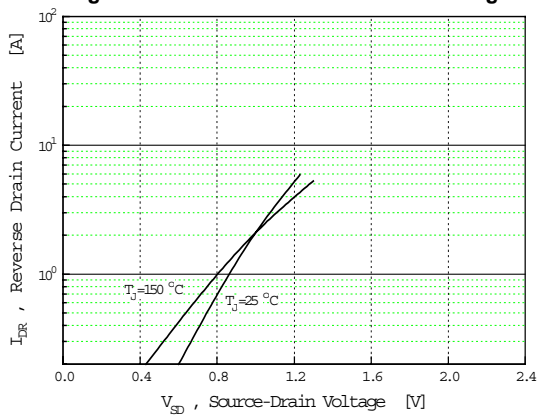

Fig 9. Gate Charge vs. Gate-Source Voltage

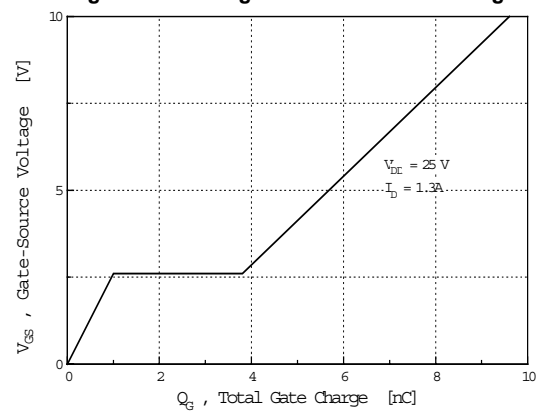
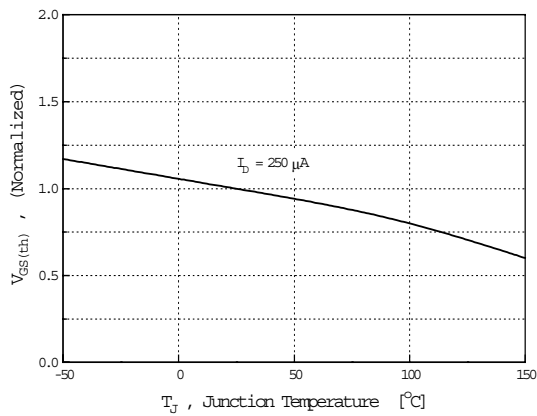

Fig 10. Threshold Voltage



TRADEMARKS

The following are registered and unregistered trademarks Fairchild Semiconductor owns or is authorized to use and is not intended to be an exhaustive list of all such trademarks.

ACEx™	FAST®	ISOPLANAR™	PowerSaver™	SuperSOT™-8
ActiveArray™	FASTr™	LittleFET™	PowerTrench®	SyncFET™
Bottomless™	FPST™	MICROCOUPLER™	QFET®	TinyLogic®
Build it Now™	FRFET™	MicroFET™	QS™	TINYOPTO™
CoolFET™	GlobalOptoisolator™	MicroPak™	QT Optoelectronics™	TruTranslation™
CROSSVOLT™	GTO™	MICROWIRE™	Quiet Series™	UHC™
DOME™	HiSeC™	MSX™	RapidConfigure™	UltraFET®
EcoSPARK™	I ² C™	MSXPro™	RapidConnect™	UniFET™
E ² C MOS™	i-Lo™	OCX™	μSerDes™	VCX™
EnSigna™	ImpliedDisconnect™	OCXPro™	SILENT SWITCHER®	Wire™
FACT™	IntelliMAX™	OPTOLOGIC®	SMART START™	
FACT Quiet Series™		OPTOPLANAR™	SPM™	
Across the board. Around the world.™		PACMAN™	Stealth™	
The Power Franchise®		POP™	SuperFET™	
Programmable Active Droop™		Power247™	SuperSOT™-3	
		PowerEdge™	SuperSOT™-6	

DISCLAIMER

FAIRCHILD SEMICONDUCTOR RESERVES THE RIGHT TO MAKE CHANGES WITHOUT FURTHER NOTICE TO ANY PRODUCTS HEREIN TO IMPROVE RELIABILITY, FUNCTION OR DESIGN. FAIRCHILD DOES NOT ASSUME ANY LIABILITY ARISING OUT OF THE APPLICATION OR USE OF ANY PRODUCT OR CIRCUIT DESCRIBED HEREIN; NEITHER DOES IT CONVEY ANY LICENSE UNDER ITS PATENT RIGHTS, NOR THE RIGHTS OF OTHERS.

LIFE SUPPORT POLICY

FAIRCHILD'S PRODUCTS ARE NOT AUTHORIZED FOR USE AS CRITICAL COMPONENTS IN LIFE SUPPORT DEVICES OR SYSTEMS WITHOUT THE EXPRESS WRITTEN APPROVAL OF FAIRCHILD SEMICONDUCTOR CORPORATION. As used herein:

1. Life support devices or systems are devices or systems which, (a) are intended for surgical implant into the body, or (b) support or sustain life, or (c) whose failure to perform when properly used in accordance with instructions for use provided in the labeling, can be reasonably expected to result in significant injury to the user.
2. A critical component is any component of a life support device or system whose failure to perform can be reasonably expected to cause the failure of the life support device or system, or to affect its safety or effectiveness.

PRODUCT STATUS DEFINITIONS

Definition of Terms

Datasheet Identification	Product Status	Definition
Advance Information	Formative or In Design	This datasheet contains the design specifications for product development. Specifications may change in any manner without notice.
Preliminary	First Production	This datasheet contains preliminary data, and supplementary data will be published at a later date. Fairchild Semiconductor reserves the right to make changes at any time without notice in order to improve design.
No Identification Needed	Full Production	This datasheet contains final specifications. Fairchild Semiconductor reserves the right to make changes at any time without notice in order to improve design.
Obsolete	Not In Production	This datasheet contains specifications on a product that has been discontinued by Fairchild semiconductor. The datasheet is printed for reference information only.

Looking for pricing, stock, or lifecycle information?

Click below to explore more details on WIN SOURCE:

- ⊖ [View SSD2007ATF on WIN SOURCE](#)
- ⊖ [Fairchild/ON Semiconductor Information](#)

Optimize Your Supply Chain with WIN SOURCE Solutions

- ✓ Global Sourcing Solution
- ✓ Obsolete Management
- ✓ Cost Control Management
- ✓ Shortage Management
- ✓ Alternative Solution
- ✓ Excess Inventory Management