



**THE DATASHEET OF  
LP2985A-33DBVTG4**



## LP2985 150-mA Low-noise Low-dropout Regulator With Shutdown

### 1 Features

- Output Tolerance of
  - 1% (A Grade)
  - 1.5% (Standard Grade)
- Ultra-Low Dropout, Typically
  - 280 mV at Full Load of 150 mA
  - 7 mV at 1 mA
- Wide  $V_{IN}$  Range: 16 V Max
- Low  $I_Q$ : 850  $\mu$ A at Full Load at 150 mA
- Shutdown Current: 0.01  $\mu$ A Typ
- Low Noise: 30  $\mu$ V<sub>RMS</sub> With 10-nF Bypass Capacitor
- Stable With Low-ESR Capacitors, Including Ceramic
- Overcurrent and Thermal Protection
- High Peak-Current Capability
- ESD Protection Exceeds JESD 22
  - 2000-V Human-Body Model (A114-A)
  - 200-V Machine Model (A115-A)

### 2 Applications

- Portable Devices
- Digital Cameras and Camcorders
- CD Players
- MP3 Players

### 3 Description

The LP2985 family of fixed-output, low-dropout regulators offers exceptional, cost-effective performance for both portable and nonportable applications. Available in voltages of 1.8 V, 2.5 V, 2.8 V, 2.9 V, 3 V, 3.1 V, 3.3 V, 5 V, and 10 V, the family has an output tolerance of 1% for the A version (1.5% for the non-A version) and is capable of delivering 150-mA continuous load current. Standard regulator features, such as overcurrent and overtemperature protection, are included.

#### Device Information<sup>(1)</sup>

| PART NUMBER | PACKAGE    | BODY SIZE (NOM)   |
|-------------|------------|-------------------|
| LP2985      | SOT-23 (5) | 2.90 mm x 1.60 mm |

(1) For all available packages, see the orderable addendum at the end of the data sheet.

#### Dropout Voltage vs Temperature

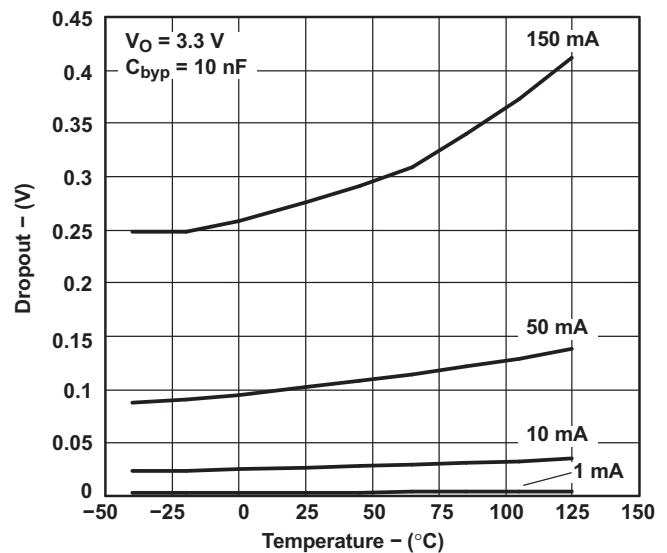

## Table of Contents

|  |           |  |           |
|--|-----------|--|-----------|
| <b>1 Features</b> .....                        | <b>1</b>  | 7.2 Functional Block Diagram .....                               | <b>11</b> |
| <b>2 Applications</b> .....                    | <b>1</b>  | 7.3 Feature Description .....                                    | <b>11</b> |
| <b>3 Description</b> .....                     | <b>1</b>  | 7.4 Device Functional Modes .....                                | <b>11</b> |
| <b>4 Revision History</b> .....                | <b>2</b>  | <b>8 Application and Implementation</b> .....                    | <b>12</b> |
| <b>5 Pin Configuration and Functions</b> ..... | <b>3</b>  | 8.1 Application Information .....                                | <b>12</b> |
| <b>6 Specifications</b> .....                  | <b>4</b>  | <b>9 Power Supply Recommendations</b> .....                      | <b>16</b> |
| 6.1 Absolute Maximum Ratings .....             | <b>4</b>  | <b>10 Layout</b> .....   | <b>17</b> |
| 6.2 ESD Ratings .....                          | <b>4</b>  | 10.1 Layout Guidelines .....                                     | <b>17</b> |
| 6.3 Recommended Operating Conditions .....     | <b>4</b>  | 10.2 Layout Example .....  | <b>17</b> |
| 6.4 Thermal Information .....                  | <b>4</b>  | <b>11 Device and Documentation Support</b> .....                 | <b>17</b> |
| 6.5 Electrical Characteristics .....           | <b>5</b>  | 11.1 Trademarks .....  | <b>17</b> |
| 6.6 Typical Characteristics .....              | <b>7</b>  | 11.2 Electrostatic Discharge Caution .....                       | <b>17</b> |
| <b>7 Detailed Description</b> .....            | <b>11</b> | 11.3 Glossary .....  | <b>17</b> |
| 7.1 Overview .....                             | <b>11</b> | <b>12 Mechanical, Packaging, and Orderable Information</b> ..... | <b>17</b> |

## 4 Revision History

| Changes from Revision N (June 2011) to Revision O   | Page     |
|---|----------|
| • Added <i>Applications</i> , <i>Device Information</i> table, <i>Pin Functions</i> table, <i>ESD Ratings</i> table, <i>Thermal Information</i> table, <i>Feature Description</i> section, <i>Device Functional Modes</i> , <i>Application and Implementation</i> section, <i>Power Supply Recommendations</i> section, <i>Layout</i> section, <i>Device and Documentation Support</i> section, and <i>Mechanical, Packaging, and Orderable Information</i> section. .... | <b>1</b> |
| • Deleted <i>Ordering Information</i> table. ....   | <b>1</b> |

## 5 Pin Configuration and Functions

DBV (SOT-23) PACKAGE  
(TOP VIEW)



**Pin Functions**

| PIN       |     | TYPE | DESCRIPTION  |
|-----------|-----|------|--|
| NAME      | NO. |      |  |
| BYPASS    | 4   | I/O  | Attach a 10-nF capacitor to improve low-noise performance. |
| GND       | 2   | —    | Ground   |
| ON/OFF    | 3   | I    | Active-low shutdown pin. Tie to $V_{IN}$ if unused.        |
| $V_{IN}$  | 1   | I    | Supply input   |
| $V_{OUT}$ | 5   | O    | Voltage output   |

## 6 Specifications

### 6.1 Absolute Maximum Ratings

over virtual junction temperature range (unless otherwise noted)<sup>(1)</sup>

|                          |   | MIN   | MAX | UNIT |
|--------------------------|---|---|-----|------|
| $V_{IN}$                 | Continuous input voltage range <sup>(2)</sup> | -0.3  | 16  | V    |
| $V_{ON/ \overline{OFF}}$ | ON/ $\overline{OFF}$ input voltage range      | -0.3  | 16  | V    |
|                          | Output voltage range <sup>(3)</sup>           | -0.3  | 9   | V    |
| $I_O$                    | Output current <sup>(4)</sup>                 | Internally limited<br>(short-circuit protected) |     | —    |
| $\theta_{JA}$            | Package thermal impedance <sup>(4) (5)</sup>  |   | 206 | °C/W |
| $T_J$                    | Operating virtual junction temperature        |   | 150 | °C   |
| $T_{stg}$                | Storage temperature range                     | -65   | 150 | °C   |

- (1) Stresses beyond those listed under "absolute maximum ratings" may cause permanent damage to the device. These are stress ratings only, and functional operation of the device at these or any other conditions beyond those indicated under [Recommended Operating Conditions](#) is not implied. Exposure to absolute-maximum-rated conditions for extended periods may affect device reliability.
- (2) The PNP pass transistor has a parasitic diode connected between the input and output. This diode normally is reverse biased ( $V_{IN} > V_{OUT}$ ), but will be forward biased if the output voltage exceeds the input voltage by a diode drop (see [Application Information](#) for more details).
- (3) If load is returned to a negative power supply in a dual-supply system, the output must be diode clamped to GND.
- (4) Maximum power dissipation is a function of  $T_J(\max)$ ,  $\theta_{JA}$ , and  $T_A$ . The maximum allowable power dissipation at any allowable ambient temperature is  $P_D = (T_J(\max) - T_A)/\theta_{JA}$ . Operating at the absolute maximum  $T_J$  of 150°C can affect reliability.
- (5) The package thermal impedance is calculated in accordance with JESD 51-7.

### 6.2 ESD Ratings

|  |   | VALUE | UNIT |
|--|---|-------|------|
| $V_{(ESD)}$  | Electrostatic discharge   |       |      |
|  | Human body model (HBM), per ANSI/ESDA/JEDEC JS-001, all pins <sup>(1)</sup> | 2000  | V    |
| Charged device model (CDM), per JEDEC specification JESD22-C101, all pins <sup>(2)</sup> | 1000  |       |      |

- (1) JEDEC document JEP155 states that 500-V HBM allows safe manufacturing with a standard ESD control process.
- (2) JEDEC document JEP157 states that 250-V CDM allows safe manufacturing with a standard ESD control process.

### 6.3 Recommended Operating Conditions

|                          |                                    | MIN                | MAX      | UNIT |
|--------------------------|------------------------------------|--------------------|----------|------|
| $V_{IN}$                 | Supply input voltage               | 2.2 <sup>(1)</sup> | 16       | V    |
| $V_{ON/ \overline{OFF}}$ | ON/ $\overline{OFF}$ input voltage | 0                  | $V_{IN}$ | V    |
| $I_{OUT}$                | Output current                     |                    | 150      | mA   |
| $T_J$                    | Virtual junction temperature       | -40                | 125      | °C   |

- (1) Recommended minimum  $V_{IN}$  is the greater of 2.5 V or  $V_{OUT(\max)} +$  rated dropout voltage (max) for operating  $I_L$ .

### 6.4 Thermal Information

| THERMAL METRIC <sup>(1)</sup> | LP2985                                 | UNIT |      |
|-------------------------------|--|------|------|
|                               | DBV                                    |      |      |
|                               | 5 PINS                                 |      |      |
| $R_{\theta JA}$               | Junction-to-ambient thermal resistance | 206  | °C/W |

- (1) For more information about traditional and new thermal metrics, see the [IC Package Thermal Metrics](#) application report, [SPRA953](#).

## 6.5 Electrical Characteristics

at specified virtual junction temperature range,  $V_{IN} = V_{OUT(NOM)} + 1\text{ V}$ ,  $V_{ON/OFF} = 2\text{ V}$ ,  $C_{IN} = 1\text{ }\mu\text{F}$ ,  $I_L = 1\text{ mA}$ ,  $C_{OUT} = 4.7\text{ }\mu\text{F}$  (unless otherwise noted)

| PARAMETER   | TEST CONDITIONS  | T <sub>J</sub>             | LP2985A-xx |       |       | LP2985-xx |       |               | UNIT              |
|---|--|----------------------------|------------|-------|-------|-----------|-------|---------------|-------------------|
|   |  |                            | MIN        | TYP   | MAX   | MIN       | TYP   | MAX           |                   |
| $\Delta V_{OUT}$ Output voltage tolerance         | $I_L = 1\text{ mA}$  | 25°C                       | -1         |       | 1     | -1.5      |       | 1.5           | %V <sub>NOM</sub> |
|   | $1\text{ mA} \leq I_L \leq 50\text{ mA}$                       | 25°C                       | -1.5       |       | 1.5   | -2.5      |       | 2.5           |                   |
|   |  | -40°C to 125°C             | -2.5       |       | 2.5   | -3.5      |       | 3.5           |                   |
|   | $1\text{ mA} \leq I_L \leq 150\text{ mA}$                      | 25°C                       | -2.5       |       | 2.5   | -3        |       | 3             |                   |
| -40°C to 125°C                                    |  | -3.5                       |            | 3.5   | -4    |           | 4     |               |                   |
| Line regulation                                   | $V_{IN} = [V_{OUT(NOM)} + 1\text{ V}] \text{ to } 16\text{ V}$ | 25°C                       |            | 0.007 | 0.014 |           | 0.007 | 0.014         | %V                |
|   |  | -40°C to 125°C             |            |       | 0.032 |           |       | 0.032         |                   |
| $V_{IN} - V_{OUT}$ Dropout voltage <sup>(1)</sup> | $I_L = 0$  | 25°C                       |            | 1     | 3     |           | 1     | 3             | mV                |
|   |  | -40°C to 125°C             |            |       | 5     |           |       | 5             |                   |
|   | $I_L = 1\text{ mA}$  | 25°C                       |            | 7     | 10    |           | 7     | 10            |                   |
|   |  | -40°C to 125°C             |            |       | 15    |           |       | 15            |                   |
|   | $I_L = 10\text{ mA}$   | 25°C                       |            | 40    | 60    |           | 40    | 60            |                   |
|   |  | -40°C to 125°C             |            |       | 90    |           |       | 90            |                   |
|   | $I_L = 50\text{ mA}$   | 25°C                       |            | 120   | 150   |           | 120   | 150           |                   |
|   |  | -40°C to 125°C             |            |       | 225   |           |       | 225           |                   |
|   | $I_L = 150\text{ mA}$  | 25°C                       |            | 280   | 350   |           | 280   | 350           |                   |
|   |  | -40°C to 125°C             |            |       | 575   |           |       | 575           |                   |
| $I_{GND}$ GND pin current                         | $I_L = 0$  | 25°C                       |            | 65    | 95    |           | 65    | 95            | $\mu\text{A}$     |
|   |  | 25°C (LP2985-10)           |            |       | 125   |           |       | 125           |                   |
|   |  | -40°C to 125°C             |            |       | 125   |           |       | 125           |                   |
|   |  | -40°C to 125°C (LP2985-10) |            |       | 160   |           |       | 160           |                   |
|   | $I_L = 1\text{ mA}$  | 25°C                       |            | 75    | 110   |           | 75    | 110           |                   |
|   |  | 25°C (LP2985-10)           |            |       | 140   |           |       | 140           |                   |
|   |  | -40°C to 125°C             |            |       | 170   |           |       | 170           |                   |
|   | $I_L = 10\text{ mA}$   | 25°C                       |            | 120   | 220   |           | 120   | 220           |                   |
|   |  | 25°C (LP2985-10)           |            |       | 250   |           |       | 250           |                   |
|   |  | -40°C to 125°C             |            |       | 400   |           |       | 400           |                   |
|   | $I_L = 50\text{ mA}$   | 25°C                       |            | 350   | 600   |           | 350   | 600           |                   |
|   |  | 25°C (LP2985-10)           |            |       | 650   |           |       | 650           |                   |
|   |  | -40°C to 125°C             |            |       | 1000  |           |       | 1000          |                   |
|   | $I_L = 150\text{ mA}$  | 25°C                       |            | 850   | 1500  |           | 850   | 1500          |                   |
|   |  | 25°C (LP2985-10)           |            |       | 1800  |           |       | 1800          |                   |
|   |  | -40°C to 125°C             |            |       | 2500  |           |       | 2500          |                   |
| $V_{ON/OFF} < 0.3\text{ V (OFF)}$                 | 25°C   |                            | 0.01       | 0.8   |       | 0.01      | 0.8   |               |                   |
|   | -40°C to 105°C   |                            |            | 0.05  | 2     |           | 0.05  | 2             |                   |
|   | -40°C to 125°C   |                            |            |       | 5     |           |       | 5             |                   |
| $V_{ON/OFF}$ ON/OFF input voltage <sup>(2)</sup>  | $V_{ON/OFF} = \text{HIGH} \rightarrow \text{O/P ON}$           | 25°C                       |            | 1.4   |       |           | 1.4   | V             |                   |
|   |  | -40°C to 125°C             |            | 1.6   |       |           | 1.6   |               |                   |
|   | $V_{ON/OFF} = \text{LOW} \rightarrow \text{O/P OFF}$           | 25°C                       |            | 0.55  |       |           | 0.55  |               |                   |
|   |  | -40°C to 125°C             |            |       | 0.15  |           |       |               | 0.15              |
| $I_{ON/OFF}$ ON/OFF input current                 | $V_{ON/OFF} = 0$   | 25°C                       |            | 0.01  |       |           | 0.01  | $\mu\text{A}$ |                   |
|   |  | -40°C to 125°C             |            |       | -2    |           | -2    |               |                   |
|   | $V_{ON/OFF} = 5\text{ V}$                                      | 25°C                       |            | 5     |       |           | 5     |               |                   |
|   |  | -40°C to 125°C             |            |       | 15    |           |       |               | 15                |

(1) Dropout voltage is defined as the input-to-output differential at which the output voltage drops 100 mV below the value measured with a 1-V differential.

(2) The ON/OFF input must be driven properly for reliable operation (see *Application Information*).

## Electrical Characteristics (continued)

at specified virtual junction temperature range,  $V_{IN} = V_{OUT(NOM)} + 1\text{ V}$ ,  $V_{ON/OFF} = 2\text{ V}$ ,  $C_{IN} = 1\text{ }\mu\text{F}$ ,  $I_L = 1\text{ mA}$ ,  $C_{OUT} = 4.7\text{ }\mu\text{F}$  (unless otherwise noted)

| PARAMETER   | TEST CONDITIONS  | $T_J$ | LP2985A-xx |     |     | LP2985-xx |     |     | UNIT          |
|---|--|-------|------------|-----|-----|-----------|-----|-----|---------------|
|   |  |       | MIN        | TYP | MAX | MIN       | TYP | MAX |               |
| $V_n$ Output noise (RMS)                                | BW = 300 Hz to 50 kHz,<br>$C_{OUT} = 10\text{ }\mu\text{F}$ ,<br>$C_{BYPASS} = 10\text{ nF}$ | 25°C  |            | 30  |     |           | 30  |     | $\mu\text{V}$ |
| $\frac{\Delta V_{OUT}}{\Delta V_{IN}}$ Ripple rejection | $f = 1\text{ kHz}$ , $C_{OUT} = 10\text{ }\mu\text{F}$ ,<br>$C_{BYPASS} = 10\text{ nF}$      | 25°C  |            | 45  |     |           | 45  |     | dB            |
| $I_{OUT(PK)}$ Peak output current                       | $V_{OUT} \geq V_{O(NOM)} - 5\%$  | 25°C  |            | 350 |     |           | 350 |     | mA            |
| $I_{OUT(SC)}$ Short-circuit current                     | $R_L = 0$ (steady state) <sup>(3)</sup>  | 25°C  |            | 400 |     |           | 400 |     | mA            |

(3) See [Figure 6](#) in *Typical Performance Characteristics*.

## 6.6 Typical Characteristics

$C_{IN} = 1 \mu\text{F}$ ,  $C_{OUT} = 4.7 \mu\text{F}$ ,  $V_{IN} = V_{OUT(NOM)} + 1 \text{ V}$ ,  $T_A = 25^\circ\text{C}$ , ON/OFF pin tied to  $V_{IN}$  (unless otherwise specified)

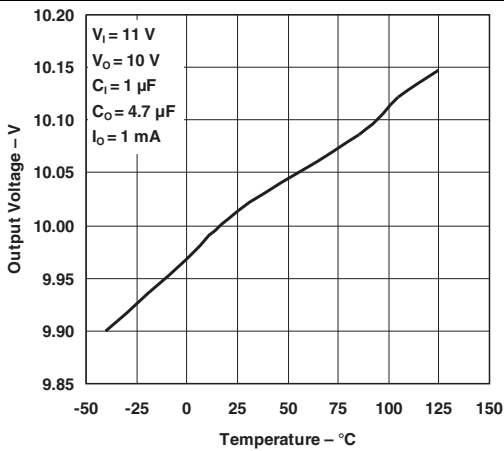

Figure 1. Output Voltage vs Temperature

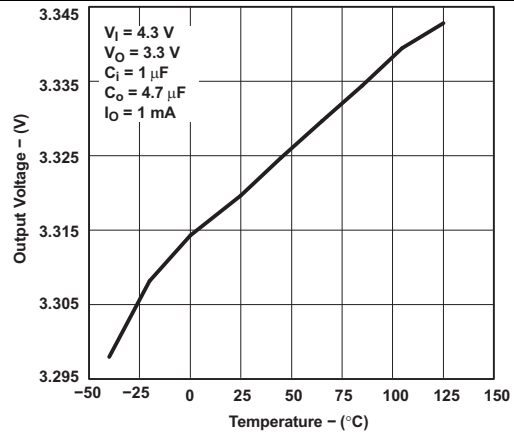

Figure 2. Output Voltage vs Temperature

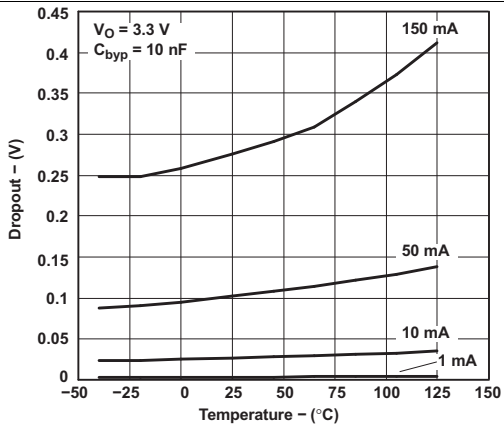

Figure 3. Dropout Voltage vs Temperature

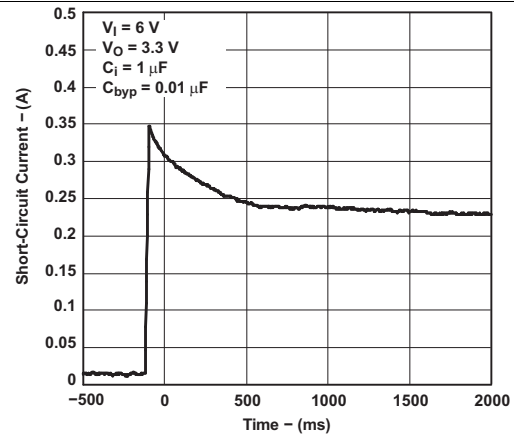

Figure 4. Short-circuit Current vs Time

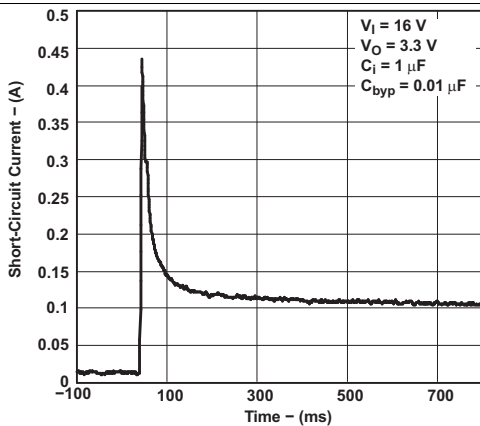

Figure 5. Short-circuit Current vs Time

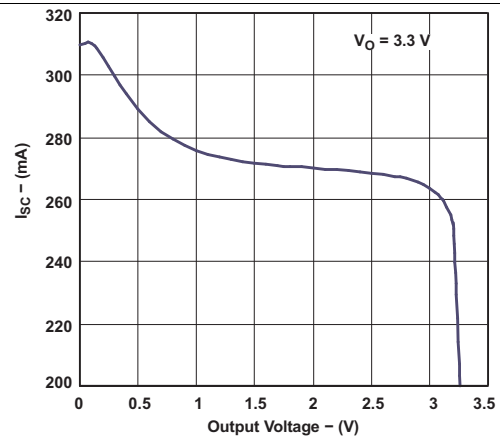

Figure 6. Short-circuit Current vs Output Voltage

### Typical Characteristics (continued)

$C_{IN} = 1 \mu\text{F}$ ,  $C_{OUT} = 4.7 \mu\text{F}$ ,  $V_{IN} = V_{OUT(NOM)} + 1 \text{ V}$ ,  $T_A = 25^\circ\text{C}$ , ON/OFF pin tied to  $V_{IN}$  (unless otherwise specified)



Figure 7. Ground Pin Current vs Load Current



Figure 8. Ripple Rejection vs Frequency



Figure 9. Ripple Rejection vs Frequency



Figure 10. Ripple Rejection vs Frequency

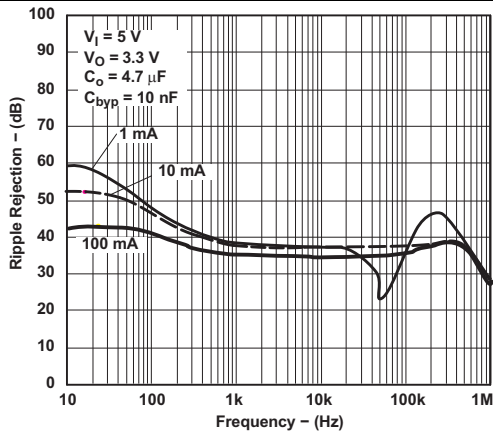

Figure 11. Ripple Rejection vs Frequency



Figure 12. Output Impedance vs Frequency

Typical Characteristics (continued)

$C_{IN} = 1 \mu\text{F}$ ,  $C_{OUT} = 4.7 \mu\text{F}$ ,  $V_{IN} = V_{OUT(NOM)} + 1 \text{ V}$ ,  $T_A = 25^\circ\text{C}$ , ON/OFF pin tied to  $V_{IN}$  (unless otherwise specified)

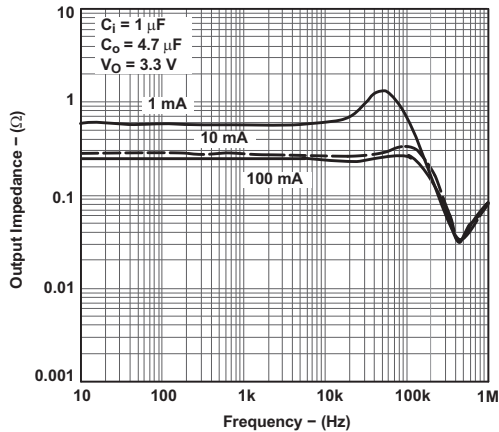

Figure 13. Output Impedance vs Frequency



Figure 14. Output Noise Density vs Frequency

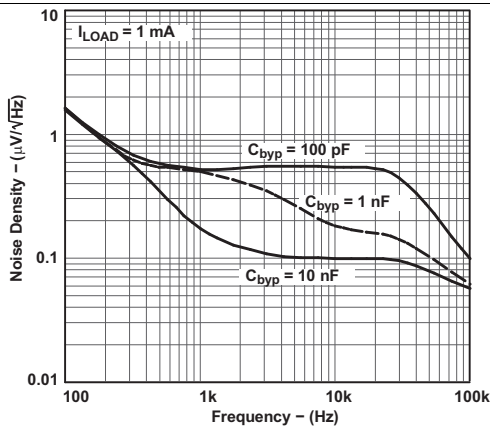

Figure 15. Output Noise Density vs Frequency



Figure 16. Input Current vs Input Voltage

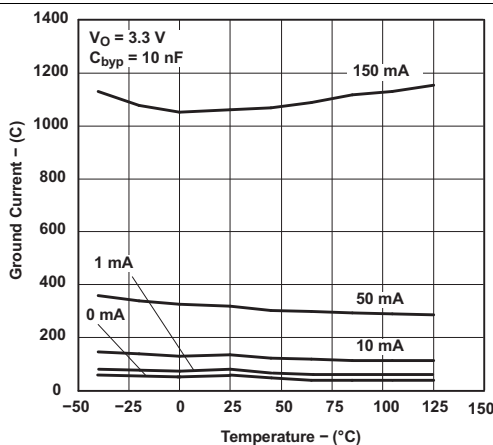

Figure 17. Ground-pin Current vs Temperature

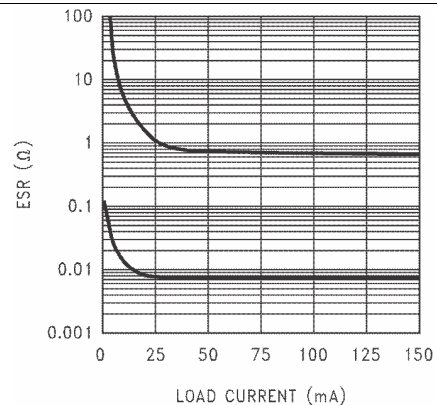
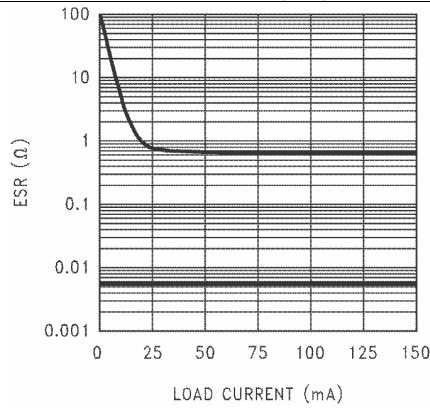

Figure 18. 2.2- $\mu\text{F}$  Stable ESR Range for Output Voltage  $\leq 2.3 \text{ V}$

**Typical Characteristics (continued)**

$C_{IN} = 1 \mu F$ ,  $C_{OUT} = 4.7 \mu F$ ,  $V_{IN} = V_{OUT(NOM)} + 1 V$ ,  $T_A = 25^\circ C$ , ON/OFF pin tied to  $V_{IN}$  (unless otherwise specified)



**Figure 19. 4.7- $\mu F$  Stable ESR Range for Output Voltage  $\leq 2.3 V$**

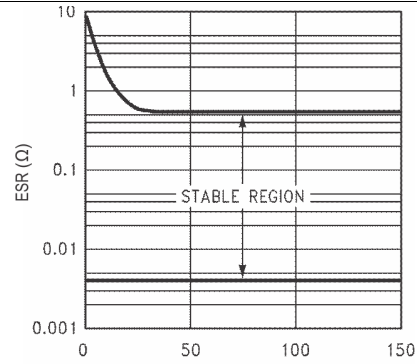

**Figure 20. 2.2- $\mu F$ /3.3- $\mu F$  Stable ESR Range for Output Voltage  $\geq 2.5 V$**

## 7 Detailed Description

### 7.1 Overview

The LP2985 family of fixed-output, low-dropout regulators offers exceptional, cost-effective performance for both portable and nonportable applications. Available in voltages of 1.8 V, 2.5 V, 2.8 V, 2.9 V, 3 V, 3.1 V, 3.3 V, 5 V, and 10 V, the family has an output tolerance of 1% for the A version (1.5% for the non-A version) and is capable of delivering 150-mA continuous load current. Standard regulator features, such as overcurrent and overtemperature protection, are included.

### 7.2 Functional Block Diagram



### 7.3 Feature Description

The LP2985 has a host of features that makes the regulator an ideal candidate for a variety of portable applications:

- Low dropout: A PNP pass element allows a typical dropout of 280 mV at 150-mA load current and 7 mV at 1-mA load.
- Low quiescent current: The use of a vertical PNP process allows for quiescent currents that are considerably lower than those associated with traditional lateral PNP regulators.
- Shutdown: A shutdown feature is available, allowing the regulator to consume only 0.01  $\mu\text{A}$  when the  $\text{ON}/\overline{\text{OFF}}$  pin is pulled low.
- Low-ESR-capacitor friendly: The regulator is stable with low-ESR capacitors, allowing the use of small, inexpensive, ceramic capacitors in cost-sensitive applications.
- Low noise: A BYPASS pin allows for low-noise operation, with a typical output noise of 30  $\mu\text{V}_{\text{RMS}}$ , with the use of a 10-nF bypass capacitor.
- Small packaging: For the most space-constrained needs, the regulator is available in the SOT-23 package.

### 7.4 Device Functional Modes

#### 7.4.1 Normal Operation

In normal operation, the device will output a fixed voltage corresponding with the orderable part number. The device can deliver 150 mA of continuous load current.

#### 7.4.2 Shutdown Mode

Set the  $\text{ON}/\overline{\text{OFF}}$  pin low to shut down the device when  $V_{\text{IN}}$  is still present. If a shutdown mode is not needed, tie the pin to  $V_{\text{IN}}$ . For proper operation, do not leave  $\text{ON}/\overline{\text{OFF}}$  unconnected, and apply a signal with a slew rate of  $\geq 40 \text{ mV}/\mu\text{s}$ .

## 8 Application and Implementation

### NOTE

Information in the following applications sections is not part of the TI component specification, and TI does not warrant its accuracy or completeness. TI's customers are responsible for determining suitability of components for their purposes. Customers should validate and test their design implementation to confirm system functionality.

### 8.1 Application Information

The following application schematic shows the standard usage of the LP2985 as a low-dropout regulator.

#### 8.1.1 Typical Application



#### 8.1.2 Design Requirements

Minimum  $C_{OUT}$  value for stability (can be increased without limit for improved stability and transient response)

$\overline{ON/OFF}$  must be actively terminated. Connect to  $V_{IN}$  if shutdown feature is not used.

Optional BYPASS capacitor for low-noise operation

#### 8.1.3 Capacitors

##### 8.1.3.1 Input Capacitor ( $C_{IN}$ )

A minimum value of 1  $\mu\text{F}$  (over the entire operating temperature range) is required at the input of the LP2985. In addition, this input capacitor should be located within 1 cm of the input pin and connected to a clean analog ground. There are no equivalent series resistance (ESR) requirements for this capacitor, and the capacitance can be increased without limit.

## Application Information (continued)

### 8.1.3.2 Output Capacitor ( $C_{OUT}$ )

As an advantage over other regulators, the LP2985 permits the use of low-ESR capacitors at the output, including ceramic capacitors that can have an ESR as low as 5 m $\Omega$ . Tantalum and film capacitors also can be used if size and cost are not issues. The output capacitor also should be located within 1 cm of the output pin and be returned to a clean analog ground.

As with other PNP LDOs, stability conditions require the output capacitor to have a minimum capacitance and an ESR that falls within a certain range.

- Minimum  $C_{OUT}$ : 2.2  $\mu$ F (can be increased without limit to improve transient response stability margin)
- ESR range: see [Figure 18](#) through [Figure 20](#)

It is critical that both the minimum capacitance and ESR requirement be met *over the entire operating temperature range*. Depending on the type of capacitors used, both these parameters can vary significantly with temperature (see *capacitor characteristics*).

### 8.1.3.3 Noise Bypass Capacitor ( $C_{BYPASS}$ )

The LP2985 allows for low-noise performance with the use of a bypass capacitor that is connected to the internal bandgap reference via the BYPASS pin. This high-impedance bandgap circuitry is biased in the microampere range and, thus, cannot be loaded significantly, otherwise, its output – and, correspondingly, the output of the regulator – changes. Thus, for best output accuracy, dc leakage current through  $C_{BYPASS}$  should be minimized as much as possible and never should exceed 100 nA.

A 10-nF capacitor is recommended for  $C_{BYPASS}$ . Ceramic and film capacitors are well suited for this purpose.

### 8.1.3.4 Reverse Input-Output Voltage

There is an inherent diode present across the PNP pass element of the LP2985.

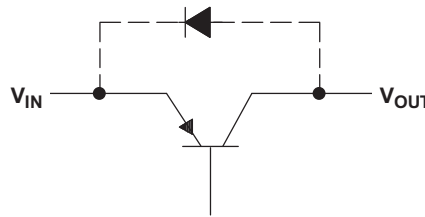

With the anode connected to the output, this diode is reverse biased during normal operation, since the input voltage is higher than the output. However, if the output is pulled higher than the input for any reason, this diode is forward biased and can cause a parasitic silicon-controlled rectifier (SCR) to latch, resulting in high current flowing from the output to the input. Thus, to prevent possible damage to the regulator in any application where the output may be pulled above the input, or the input may be shorted to ground, an external Schottky diode should be connected between the output and input. With the anode on output, this Schottky limits the reverse voltage across the output and input pins to ~0.3 V, preventing the regulator's internal diode from forward biasing.



## Application Information (continued)

### 8.1.4 Detailed Design Procedure

#### 8.1.4.1 Capacitor Characteristics

##### 8.1.4.1.1 Ceramics

Ceramic capacitors are ideal choices for use on the output of the LP2985 for several reasons. For capacitances in the range of 2.2  $\mu\text{F}$  to 4.7  $\mu\text{F}$ , ceramic capacitors have the lowest cost and the lowest ESR, making them choice candidates for filtering high-frequency noise. For instance, a typical 2.2- $\mu\text{F}$  ceramic capacitor has an ESR in the range of 10 m $\Omega$  to 20 m $\Omega$  and, thus, satisfies minimum ESR requirements of the regulator.

Ceramic capacitors have one major disadvantage that must be taken into account – a poor temperature coefficient, where the capacitance can vary significantly with temperature. For instance, a large-value ceramic capacitor ( $\geq 2.2 \mu\text{F}$ ) can lose more than half of its capacitance as the temperature rises from 25°C to 85°C. Thus, a 2.2- $\mu\text{F}$  capacitor at 25°C drops well below the minimum  $C_{\text{OUT}}$  required for stability, as ambient temperature rises. For this reason, select an output capacitor that maintains the minimum 2.2  $\mu\text{F}$  required for stability over the entire operating temperature range. Note that there are some ceramic capacitors that can maintain a  $\pm 15\%$  capacitance tolerance over temperature.

##### 8.1.4.1.2 Tantalum

Tantalum capacitors can be used at the output of the LP2985, but there are significant disadvantages that could prohibit their use:

- In the 1- $\mu\text{F}$  to 4.7- $\mu\text{F}$  range, tantalum capacitors are more expensive than ceramics of the equivalent capacitance and voltage ratings.
- Tantalum capacitors have higher ESRs than their equivalent-sized ceramic counterparts. Thus, to meet the ESR requirements, a higher-capacitance tantalum may be required, at the expense of larger size and higher cost.
- The ESR of a tantalum capacitor increases as temperature drops, as much as double from 25°C to –40°C. Thus, ESR margins must be maintained over the temperature range to prevent regulator instability.

#### 8.1.4.2 ON/OFF Operation

The LP2985 allows for a shutdown mode via the ON/OFF pin. Driving the pin LOW ( $\leq 0.3 \text{ V}$ ) turns the device OFF; conversely, a HIGH ( $\geq 1.6 \text{ V}$ ) turns the device ON. If the shutdown feature is not used, ON/OFF should be connected to the input to ensure that the regulator is on at all times. For proper operation, do not leave ON/OFF unconnected, and apply a signal with a slew rate of  $\geq 40 \text{ mV}/\mu\text{s}$ .

### 8.1.5 Application Curves



Application Information (continued)

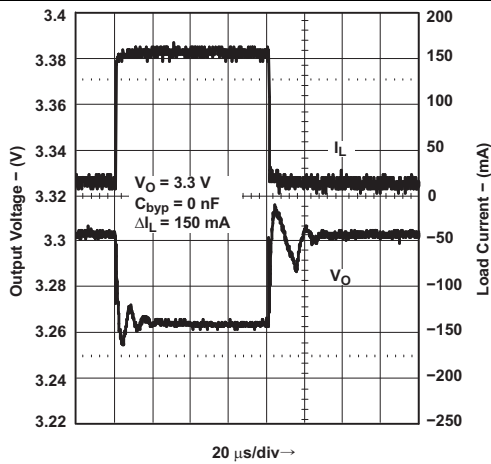

Figure 23. Load Transient Response



Figure 24. Line Transient Response

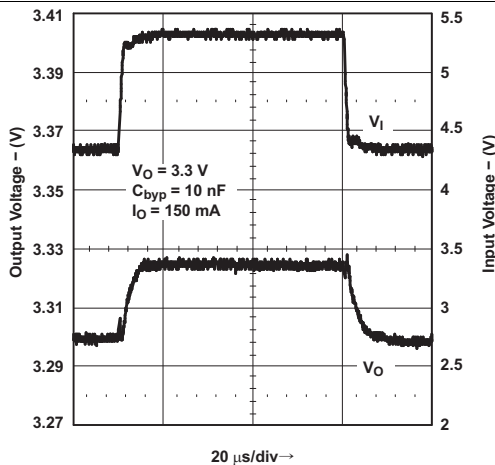

Figure 25. Line Transient Response



Figure 26. Line Transient Response

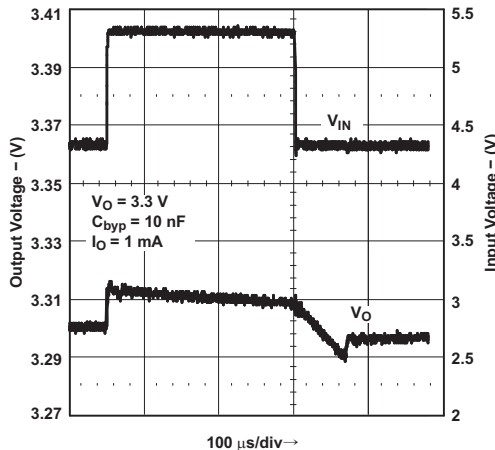

Figure 27. Line Transient Response

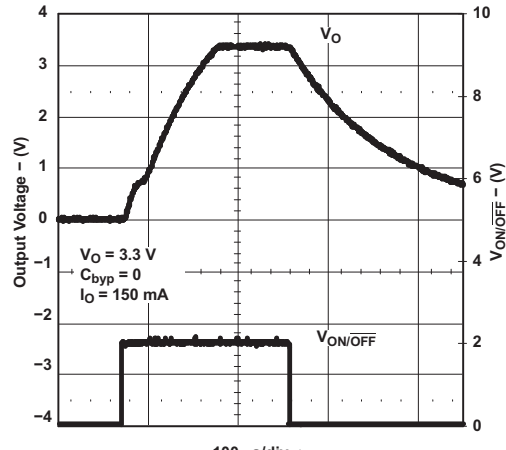

Figure 28. Turn-on Time

Application Information (continued)



9 Power Supply Recommendations

A power supply may be used at the input voltage within the ranges given in the *Recommended Operating Conditions* table. It is recommended to use bypass capacitors as described in *Layout Guidelines*.

## 10 Layout

### 10.1 Layout Guidelines

- It is recommended that the input pin be bypassed to ground with a bypass-capacitor.
- The optimum placement of the bypass capacitor is closest to the  $V_{IN}$  of the device and GND of the system. Care must be taken to minimize the loop area formed by the bypass-capacitor connection, the  $V_{IN}$  pin, and the GND pin of the system.
- For operation at full-rated load, it is recommended to use wide trace lengths to eliminate IR drop and heat dissipation.

### 10.2 Layout Example

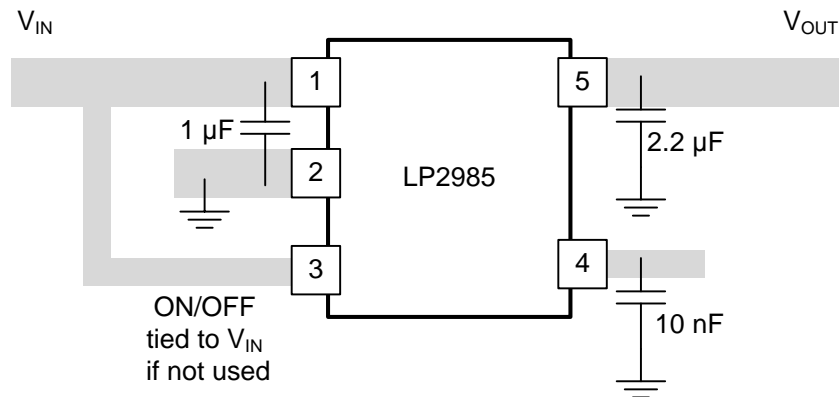

**Figure 32. Layout Diagram**

## 11 Device and Documentation Support

### 11.1 Trademarks

All trademarks are the property of their respective owners.

### 11.2 Electrostatic Discharge Caution



These devices have limited built-in ESD protection. The leads should be shorted together or the device placed in conductive foam during storage or handling to prevent electrostatic damage to the MOS gates.

### 11.3 Glossary

[SLYZ022](#) — *TI Glossary*.

This glossary lists and explains terms, acronyms, and definitions.

## 12 Mechanical, Packaging, and Orderable Information

The following pages include mechanical, packaging, and orderable information. This information is the most current data available for the designated devices. This data is subject to change without notice and revision of this document. For browser-based versions of this data sheet, refer to the left-hand navigation.

**PACKAGING INFORMATION**

| Orderable Device | Status<br>(1) | Package Type | Package Drawing | Pins | Package Qty | Eco Plan<br>(2)         | Lead/Ball Finish<br>(6) | MSL Peak Temp<br>(3) | Op Temp (°C) | Device Marking<br>(4/5) | Samples                 |
|------------------|---------------|--------------|-----------------|------|-------------|-------------------------|-------------------------|----------------------|--------------|-------------------------|-------------------------|
| LP2985-10DBVR    | ACTIVE        | SOT-23       | DBV             | 5    | 3000        | Green (RoHS & no Sb/Br) | CU NIPDAU               | Level-1-260C-UNLIM   | -40 to 125   | LRCG                    | <a href="#">Samples</a> |
| LP2985-10DBVT    | ACTIVE        | SOT-23       | DBV             | 5    | 250         | Green (RoHS & no Sb/Br) | CU NIPDAU               | Level-1-260C-UNLIM   | -40 to 125   | LRCG                    | <a href="#">Samples</a> |
| LP2985-18DBVR    | ACTIVE        | SOT-23       | DBV             | 5    | 3000        | Green (RoHS & no Sb/Br) | CU NIPDAU   CU SN       | Level-1-260C-UNLIM   | -40 to 125   | (LPHG, LPHL)            | <a href="#">Samples</a> |
| LP2985-18DBVRE4  | ACTIVE        | SOT-23       | DBV             | 5    | 3000        | Green (RoHS & no Sb/Br) | CU NIPDAU               | Level-1-260C-UNLIM   | -40 to 125   | LPHG                    | <a href="#">Samples</a> |
| LP2985-18DBVRG4  | ACTIVE        | SOT-23       | DBV             | 5    | 3000        | Green (RoHS & no Sb/Br) | CU NIPDAU               | Level-1-260C-UNLIM   | -40 to 125   | LPHG                    | <a href="#">Samples</a> |
| LP2985-18DBVT    | ACTIVE        | SOT-23       | DBV             | 5    | 250         | Green (RoHS & no Sb/Br) | CU NIPDAU   CU SN       | Level-1-260C-UNLIM   | -40 to 125   | (LPHG, LPHL)            | <a href="#">Samples</a> |
| LP2985-18DBVTE4  | ACTIVE        | SOT-23       | DBV             | 5    | 250         | Green (RoHS & no Sb/Br) | CU NIPDAU               | Level-1-260C-UNLIM   | -40 to 125   | LPHG                    | <a href="#">Samples</a> |
| LP2985-18DBVTG4  | ACTIVE        | SOT-23       | DBV             | 5    | 250         | Green (RoHS & no Sb/Br) | CU NIPDAU               | Level-1-260C-UNLIM   | -40 to 125   | LPHG                    | <a href="#">Samples</a> |
| LP2985-25DBVR    | ACTIVE        | SOT-23       | DBV             | 5    | 3000        | Green (RoHS & no Sb/Br) | CU NIPDAU               | Level-1-260C-UNLIM   | -40 to 125   | (LPLG, LPLL)            | <a href="#">Samples</a> |
| LP2985-25DBVT    | ACTIVE        | SOT-23       | DBV             | 5    | 250         | Green (RoHS & no Sb/Br) | CU NIPDAU               | Level-1-260C-UNLIM   | -40 to 125   | (LPLG, LPLL)            | <a href="#">Samples</a> |
| LP2985-28DBVR    | ACTIVE        | SOT-23       | DBV             | 5    | 3000        | Green (RoHS & no Sb/Br) | CU NIPDAU   CU SN       | Level-1-260C-UNLIM   | -40 to 125   | (LPGG, LPGL)            | <a href="#">Samples</a> |
| LP2985-28DBVT    | ACTIVE        | SOT-23       | DBV             | 5    | 250         | Green (RoHS & no Sb/Br) | CU NIPDAU   CU SN       | Level-1-260C-UNLIM   | -40 to 125   | (LPGG, LPGL)            | <a href="#">Samples</a> |
| LP2985-28DBVTG4  | ACTIVE        | SOT-23       | DBV             | 5    | 250         | Green (RoHS & no Sb/Br) | CU NIPDAU               | Level-1-260C-UNLIM   | -40 to 125   | LPGG                    | <a href="#">Samples</a> |
| LP2985-29DBVR    | ACTIVE        | SOT-23       | DBV             | 5    | 3000        | Green (RoHS & no Sb/Br) | CU NIPDAU               | Level-1-260C-UNLIM   | -40 to 125   | (LPMG, LPML)            | <a href="#">Samples</a> |
| LP2985-30DBVR    | ACTIVE        | SOT-23       | DBV             | 5    | 3000        | Green (RoHS & no Sb/Br) | CU NIPDAU               | Level-1-260C-UNLIM   | -40 to 125   | (LPNG, LPNL)            | <a href="#">Samples</a> |
| LP2985-30DBVRG4  | ACTIVE        | SOT-23       | DBV             | 5    | 3000        | Green (RoHS & no Sb/Br) | CU NIPDAU               | Level-1-260C-UNLIM   | -40 to 125   | (LPNG, LPNL)            | <a href="#">Samples</a> |
| LP2985-30DBVT    | ACTIVE        | SOT-23       | DBV             | 5    | 250         | Green (RoHS & no Sb/Br) | CU NIPDAU               | Level-1-260C-UNLIM   | -40 to 125   | (LPNG, LPNL)            | <a href="#">Samples</a> |

| Orderable Device | Status<br>(1) | Package Type | Package Drawing | Pins | Package Qty | Eco Plan<br>(2)         | Lead/Ball Finish<br>(6) | MSL Peak Temp<br>(3) | Op Temp (°C) | Device Marking<br>(4/5) | Samples                 |
|------------------|---------------|--------------|-----------------|------|-------------|-------------------------|-------------------------|----------------------|--------------|-------------------------|-------------------------|
| LP2985-30DBVTG4  | ACTIVE        | SOT-23       | DBV             | 5    | 250         | Green (RoHS & no Sb/Br) | CU NIPDAU               | Level-1-260C-UNLIM   | -40 to 125   | (LPNG, LPNL)            | <a href="#">Samples</a> |
| LP2985-33DBVR    | ACTIVE        | SOT-23       | DBV             | 5    | 3000        | Green (RoHS & no Sb/Br) | CU NIPDAU   CU SN       | Level-1-260C-UNLIM   | -40 to 125   | (LPFG, LPFL)            | <a href="#">Samples</a> |
| LP2985-33DBVRE4  | ACTIVE        | SOT-23       | DBV             | 5    | 3000        | Green (RoHS & no Sb/Br) | CU NIPDAU               | Level-1-260C-UNLIM   | -40 to 125   | LPFG                    | <a href="#">Samples</a> |
| LP2985-33DBVRG4  | ACTIVE        | SOT-23       | DBV             | 5    | 3000        | Green (RoHS & no Sb/Br) | CU NIPDAU               | Level-1-260C-UNLIM   | -40 to 125   | LPFG                    | <a href="#">Samples</a> |
| LP2985-33DBVT    | ACTIVE        | SOT-23       | DBV             | 5    | 250         | Green (RoHS & no Sb/Br) | CU NIPDAU   CU SN       | Level-1-260C-UNLIM   | -40 to 125   | (LPFG, LPFL)            | <a href="#">Samples</a> |
| LP2985-33DBVTE4  | ACTIVE        | SOT-23       | DBV             | 5    | 250         | Green (RoHS & no Sb/Br) | CU NIPDAU               | Level-1-260C-UNLIM   | -40 to 125   | LPFG                    | <a href="#">Samples</a> |
| LP2985-33DBVTG4  | ACTIVE        | SOT-23       | DBV             | 5    | 250         | Green (RoHS & no Sb/Br) | CU NIPDAU               | Level-1-260C-UNLIM   | -40 to 125   | LPFG                    | <a href="#">Samples</a> |
| LP2985-50DBVR    | ACTIVE        | SOT-23       | DBV             | 5    | 3000        | Green (RoHS & no Sb/Br) | CU NIPDAU               | Level-1-260C-UNLIM   | -40 to 125   | (LPSG, LPSL)            | <a href="#">Samples</a> |
| LP2985-50DBVRG4  | ACTIVE        | SOT-23       | DBV             | 5    | 3000        | Green (RoHS & no Sb/Br) | CU NIPDAU               | Level-1-260C-UNLIM   | -40 to 125   | (LPSG, LPSL)            | <a href="#">Samples</a> |
| LP2985-50DBVT    | ACTIVE        | SOT-23       | DBV             | 5    | 250         | Green (RoHS & no Sb/Br) | CU NIPDAU               | Level-1-260C-UNLIM   | -40 to 125   | (LPSG, LPSL)            | <a href="#">Samples</a> |
| LP2985-50DBVTG4  | ACTIVE        | SOT-23       | DBV             | 5    | 250         | Green (RoHS & no Sb/Br) | CU NIPDAU               | Level-1-260C-UNLIM   | -40 to 125   | (LPSG, LPSL)            | <a href="#">Samples</a> |
| LP2985A-10DBVR   | ACTIVE        | SOT-23       | DBV             | 5    | 3000        | Green (RoHS & no Sb/Br) | CU NIPDAU               | Level-1-260C-UNLIM   | -40 to 125   | LRDG                    | <a href="#">Samples</a> |
| LP2985A-10DBVT   | ACTIVE        | SOT-23       | DBV             | 5    | 250         | Green (RoHS & no Sb/Br) | CU NIPDAU               | Level-1-260C-UNLIM   | -40 to 125   | LRDG                    | <a href="#">Samples</a> |
| LP2985A-18DBVJ   | ACTIVE        | SOT-23       | DBV             | 5    | 10000       | Green (RoHS & no Sb/Br) | CU NIPDAU               | Level-1-260C-UNLIM   | -40 to 125   | LPTL                    | <a href="#">Samples</a> |
| LP2985A-18DBVR   | ACTIVE        | SOT-23       | DBV             | 5    | 3000        | Green (RoHS & no Sb/Br) | CU NIPDAU   CU SN       | Level-1-260C-UNLIM   | -40 to 125   | (LPTG, LPTL)            | <a href="#">Samples</a> |
| LP2985A-18DBVRG4 | ACTIVE        | SOT-23       | DBV             | 5    | 3000        | Green (RoHS & no Sb/Br) | CU NIPDAU               | Level-1-260C-UNLIM   | -40 to 125   | LPTG                    | <a href="#">Samples</a> |
| LP2985A-18DBVT   | ACTIVE        | SOT-23       | DBV             | 5    | 250         | Green (RoHS & no Sb/Br) | CU NIPDAU   CU SN       | Level-1-260C-UNLIM   | -40 to 125   | (LPTG, LPTL)            | <a href="#">Samples</a> |
| LP2985A-25DBVR   | ACTIVE        | SOT-23       | DBV             | 5    | 3000        | Green (RoHS & no Sb/Br) | CU NIPDAU               | Level-1-260C-UNLIM   | -40 to 125   | (LPUG, LPUL)            | <a href="#">Samples</a> |

| Orderable Device | Status<br>(1) | Package Type | Package Drawing | Pins | Package Qty | Eco Plan<br>(2)         | Lead/Ball Finish<br>(6) | MSL Peak Temp<br>(3) | Op Temp (°C) | Device Marking<br>(4/5) | Samples                 |
|------------------|---------------|--------------|-----------------|------|-------------|-------------------------|-------------------------|----------------------|--------------|-------------------------|-------------------------|
| LP2985A-25DBVRG4 | ACTIVE        | SOT-23       | DBV             | 5    | 3000        | Green (RoHS & no Sb/Br) | CU NIPDAU               | Level-1-260C-UNLIM   | -40 to 125   | (LPUG, LPUL)            | <a href="#">Samples</a> |
| LP2985A-25DBVT   | ACTIVE        | SOT-23       | DBV             | 5    | 250         | Green (RoHS & no Sb/Br) | CU NIPDAU               | Level-1-260C-UNLIM   | -40 to 125   | (LPUG, LPUL)            | <a href="#">Samples</a> |
| LP2985A-28DBVR   | ACTIVE        | SOT-23       | DBV             | 5    | 3000        | Green (RoHS & no Sb/Br) | CU NIPDAU   CU SN       | Level-1-260C-UNLIM   | -40 to 125   | (LPJG, LPJL)            | <a href="#">Samples</a> |
| LP2985A-28DBVT   | ACTIVE        | SOT-23       | DBV             | 5    | 250         | Green (RoHS & no Sb/Br) | CU NIPDAU   CU SN       | Level-1-260C-UNLIM   | -40 to 125   | (LPJG, LPJL)            | <a href="#">Samples</a> |
| LP2985A-29DBVR   | ACTIVE        | SOT-23       | DBV             | 5    | 3000        | Green (RoHS & no Sb/Br) | CU NIPDAU               | Level-1-260C-UNLIM   | -40 to 125   | (LPZG, LPZL)            | <a href="#">Samples</a> |
| LP2985A-30DBVR   | ACTIVE        | SOT-23       | DBV             | 5    | 3000        | Green (RoHS & no Sb/Br) | CU NIPDAU               | Level-1-260C-UNLIM   | -40 to 125   | (LRAG, LRAL)            | <a href="#">Samples</a> |
| LP2985A-30DBVT   | ACTIVE        | SOT-23       | DBV             | 5    | 250         | Green (RoHS & no Sb/Br) | CU NIPDAU               | Level-1-260C-UNLIM   | -40 to 125   | (LRAG, LRAL)            | <a href="#">Samples</a> |
| LP2985A-33DBVR   | ACTIVE        | SOT-23       | DBV             | 5    | 3000        | Green (RoHS & no Sb/Br) | CU NIPDAU   CU SN       | Level-1-260C-UNLIM   | -40 to 125   | (LPKG, LPKL)            | <a href="#">Samples</a> |
| LP2985A-33DBVRG4 | ACTIVE        | SOT-23       | DBV             | 5    | 3000        | Green (RoHS & no Sb/Br) | CU NIPDAU               | Level-1-260C-UNLIM   | -40 to 125   | LPKG                    | <a href="#">Samples</a> |
| LP2985A-33DBVT   | ACTIVE        | SOT-23       | DBV             | 5    | 250         | Green (RoHS & no Sb/Br) | CU NIPDAU   CU SN       | Level-1-260C-UNLIM   | -40 to 125   | (LPKG, LPKL)            | <a href="#">Samples</a> |
| LP2985A-33DBVTE4 | ACTIVE        | SOT-23       | DBV             | 5    | 250         | Green (RoHS & no Sb/Br) | CU NIPDAU               | Level-1-260C-UNLIM   | -40 to 125   | LPKG                    | <a href="#">Samples</a> |
| LP2985A-33DBVTG4 | ACTIVE        | SOT-23       | DBV             | 5    | 250         | Green (RoHS & no Sb/Br) | CU NIPDAU               | Level-1-260C-UNLIM   | -40 to 125   | LPKG                    | <a href="#">Samples</a> |
| LP2985A-50DBVR   | ACTIVE        | SOT-23       | DBV             | 5    | 3000        | Green (RoHS & no Sb/Br) | CU NIPDAU               | Level-1-260C-UNLIM   | -40 to 125   | (LR1G, LR1L)            | <a href="#">Samples</a> |
| LP2985A-50DBVRG4 | ACTIVE        | SOT-23       | DBV             | 5    | 3000        | Green (RoHS & no Sb/Br) | CU NIPDAU               | Level-1-260C-UNLIM   | -40 to 125   | (LR1G, LR1L)            | <a href="#">Samples</a> |
| LP2985A-50DBVT   | ACTIVE        | SOT-23       | DBV             | 5    | 250         | Green (RoHS & no Sb/Br) | CU NIPDAU               | Level-1-260C-UNLIM   | -40 to 125   | (LR1G, LR1L)            | <a href="#">Samples</a> |

(1) The marketing status values are defined as follows:

**ACTIVE:** Product device recommended for new designs.

**LIFEBUY:** TI has announced that the device will be discontinued, and a lifetime-buy period is in effect.

**NRND:** Not recommended for new designs. Device is in production to support existing customers, but TI does not recommend using this part in a new design.

**PREVIEW:** Device has been announced but is not in production. Samples may or may not be available.

**OBSOLETE:** TI has discontinued the production of the device.

<sup>(2)</sup> **RoHS:** TI defines "RoHS" to mean semiconductor products that are compliant with the current EU RoHS requirements for all 10 RoHS substances, including the requirement that RoHS substance do not exceed 0.1% by weight in homogeneous materials. Where designed to be soldered at high temperatures, "RoHS" products are suitable for use in specified lead-free processes. TI may reference these types of products as "Pb-Free".

**RoHS Exempt:** TI defines "RoHS Exempt" to mean products that contain lead but are compliant with EU RoHS pursuant to a specific EU RoHS exemption.

**Green:** TI defines "Green" to mean the content of Chlorine (Cl) and Bromine (Br) based flame retardants meet JS709B low halogen requirements of  $\leq 1000$ ppm threshold. Antimony trioxide based flame retardants must also meet the  $\leq 1000$ ppm threshold requirement.

<sup>(3)</sup> MSL, Peak Temp. - The Moisture Sensitivity Level rating according to the JEDEC industry standard classifications, and peak solder temperature.

<sup>(4)</sup> There may be additional marking, which relates to the logo, the lot trace code information, or the environmental category on the device.

<sup>(5)</sup> Multiple Device Markings will be inside parentheses. Only one Device Marking contained in parentheses and separated by a "-" will appear on a device. If a line is indented then it is a continuation of the previous line and the two combined represent the entire Device Marking for that device.

<sup>(6)</sup> Lead/Ball Finish - Orderable Devices may have multiple material finish options. Finish options are separated by a vertical ruled line. Lead/Ball Finish values may wrap to two lines if the finish value exceeds the maximum column width.

**Important Information and Disclaimer:** The information provided on this page represents TI's knowledge and belief as of the date that it is provided. TI bases its knowledge and belief on information provided by third parties, and makes no representation or warranty as to the accuracy of such information. Efforts are underway to better integrate information from third parties. TI has taken and continues to take reasonable steps to provide representative and accurate information but may not have conducted destructive testing or chemical analysis on incoming materials and chemicals. TI and TI suppliers consider certain information to be proprietary, and thus CAS numbers and other limited information may not be available for release.

In no event shall TI's liability arising out of such information exceed the total purchase price of the TI part(s) at issue in this document sold by TI to Customer on an annual basis.

**TAPE AND REEL INFORMATION**

**QUADRANT ASSIGNMENTS FOR PIN 1 ORIENTATION IN TAPE**

\*All dimensions are nominal

| Device          | Package Type | Package Drawing | Pins | SPQ   | Reel Diameter (mm) | Reel Width W1 (mm) | A0 (mm) | B0 (mm) | K0 (mm) | P1 (mm) | W (mm) | Pin1 Quadrant |
|-----------------|--------------|-----------------|------|-------|--------------------|--------------------|---------|---------|---------|---------|--------|---------------|
| LP2985-10DBVR   | SOT-23       | DBV             | 5    | 3000  | 178.0              | 9.0                | 3.23    | 3.17    | 1.37    | 4.0     | 8.0    | Q3            |
| LP2985-10DBVT   | SOT-23       | DBV             | 5    | 250   | 178.0              | 9.0                | 3.3     | 3.2     | 1.4     | 4.0     | 8.0    | Q3            |
| LP2985-18DBVR   | SOT-23       | DBV             | 5    | 3000  | 178.0              | 9.0                | 3.3     | 3.2     | 1.4     | 4.0     | 8.0    | Q3            |
| LP2985-18DBVRG4 | SOT-23       | DBV             | 5    | 3000  | 178.0              | 9.0                | 3.3     | 3.2     | 1.4     | 4.0     | 8.0    | Q3            |
| LP2985-18DBVTG4 | SOT-23       | DBV             | 5    | 250   | 178.0              | 9.0                | 3.23    | 3.17    | 1.37    | 4.0     | 8.0    | Q3            |
| LP2985-25DBVR   | SOT-23       | DBV             | 5    | 3000  | 178.0              | 9.0                | 3.3     | 3.2     | 1.4     | 4.0     | 8.0    | Q3            |
| LP2985-28DBVR   | SOT-23       | DBV             | 5    | 3000  | 178.0              | 9.0                | 3.23    | 3.17    | 1.37    | 4.0     | 8.0    | Q3            |
| LP2985-28DBVTG4 | SOT-23       | DBV             | 5    | 250   | 178.0              | 9.0                | 3.3     | 3.2     | 1.4     | 4.0     | 8.0    | Q3            |
| LP2985-29DBVR   | SOT-23       | DBV             | 5    | 3000  | 178.0              | 9.0                | 3.23    | 3.17    | 1.37    | 4.0     | 8.0    | Q3            |
| LP2985-30DBVR   | SOT-23       | DBV             | 5    | 3000  | 178.0              | 9.0                | 3.23    | 3.17    | 1.37    | 4.0     | 8.0    | Q3            |
| LP2985-33DBVR   | SOT-23       | DBV             | 5    | 3000  | 178.0              | 9.0                | 3.3     | 3.2     | 1.4     | 4.0     | 8.0    | Q3            |
| LP2985-33DBVRG4 | SOT-23       | DBV             | 5    | 3000  | 178.0              | 9.0                | 3.3     | 3.2     | 1.4     | 4.0     | 8.0    | Q3            |
| LP2985-33DBVT   | SOT-23       | DBV             | 5    | 250   | 178.0              | 9.0                | 3.23    | 3.17    | 1.37    | 4.0     | 8.0    | Q3            |
| LP2985-33DBVTG4 | SOT-23       | DBV             | 5    | 250   | 178.0              | 9.0                | 3.23    | 3.17    | 1.37    | 4.0     | 8.0    | Q3            |
| LP2985-50DBVR   | SOT-23       | DBV             | 5    | 3000  | 178.0              | 9.0                | 3.23    | 3.17    | 1.37    | 4.0     | 8.0    | Q3            |
| LP2985A-10DBVR  | SOT-23       | DBV             | 5    | 3000  | 178.0              | 9.0                | 3.23    | 3.17    | 1.37    | 4.0     | 8.0    | Q3            |
| LP2985A-10DBVT  | SOT-23       | DBV             | 5    | 250   | 178.0              | 9.0                | 3.3     | 3.2     | 1.4     | 4.0     | 8.0    | Q3            |
| LP2985A-18DBVJ  | SOT-23       | DBV             | 5    | 10000 | 330.0              | 8.4                | 3.17    | 3.23    | 1.37    | 4.0     | 8.0    | Q3            |

| Device           | Package Type | Package Drawing | Pins | SPQ  | Reel Diameter (mm) | Reel Width W1 (mm) | A0 (mm) | B0 (mm) | K0 (mm) | P1 (mm) | W (mm) | Pin1 Quadrant |
|------------------|--------------|-----------------|------|------|--------------------|--------------------|---------|---------|---------|---------|--------|---------------|
| LP2985A-18DBVR   | SOT-23       | DBV             | 5    | 3000 | 178.0              | 9.0                | 3.23    | 3.17    | 1.37    | 4.0     | 8.0    | Q3            |
| LP2985A-18DBVRG4 | SOT-23       | DBV             | 5    | 3000 | 178.0              | 9.0                | 3.23    | 3.17    | 1.37    | 4.0     | 8.0    | Q3            |
| LP2985A-25DBVR   | SOT-23       | DBV             | 5    | 3000 | 178.0              | 9.0                | 3.23    | 3.17    | 1.37    | 4.0     | 8.0    | Q3            |
| LP2985A-25DBVT   | SOT-23       | DBV             | 5    | 250  | 180.0              | 9.2                | 3.17    | 3.23    | 1.37    | 4.0     | 8.0    | Q3            |
| LP2985A-28DBVR   | SOT-23       | DBV             | 5    | 3000 | 178.0              | 9.0                | 3.23    | 3.17    | 1.37    | 4.0     | 8.0    | Q3            |
| LP2985A-28DBVR   | SOT-23       | DBV             | 5    | 3000 | 180.0              | 9.2                | 3.17    | 3.23    | 1.37    | 4.0     | 8.0    | Q3            |
| LP2985A-29DBVR   | SOT-23       | DBV             | 5    | 3000 | 178.0              | 9.0                | 3.23    | 3.17    | 1.37    | 4.0     | 8.0    | Q3            |
| LP2985A-30DBVR   | SOT-23       | DBV             | 5    | 3000 | 178.0              | 9.0                | 3.23    | 3.17    | 1.37    | 4.0     | 8.0    | Q3            |
| LP2985A-33DBVR   | SOT-23       | DBV             | 5    | 3000 | 178.0              | 9.0                | 3.3     | 3.2     | 1.4     | 4.0     | 8.0    | Q3            |
| LP2985A-33DBVRG4 | SOT-23       | DBV             | 5    | 3000 | 178.0              | 9.0                | 3.3     | 3.2     | 1.4     | 4.0     | 8.0    | Q3            |
| LP2985A-33DBVT   | SOT-23       | DBV             | 5    | 250  | 178.0              | 9.0                | 3.23    | 3.17    | 1.37    | 4.0     | 8.0    | Q3            |
| LP2985A-33DBVTG4 | SOT-23       | DBV             | 5    | 250  | 178.0              | 9.0                | 3.23    | 3.17    | 1.37    | 4.0     | 8.0    | Q3            |
| LP2985A-50DBVR   | SOT-23       | DBV             | 5    | 3000 | 178.0              | 9.0                | 3.23    | 3.17    | 1.37    | 4.0     | 8.0    | Q3            |

### TAPE AND REEL BOX DIMENSIONS



\*All dimensions are nominal

| Device          | Package Type | Package Drawing | Pins | SPQ  | Length (mm) | Width (mm) | Height (mm) |
|-----------------|--------------|-----------------|------|------|-------------|------------|-------------|
| LP2985-10DBVR   | SOT-23       | DBV             | 5    | 3000 | 180.0       | 180.0      | 18.0        |
| LP2985-10DBVT   | SOT-23       | DBV             | 5    | 250  | 180.0       | 180.0      | 18.0        |
| LP2985-18DBVR   | SOT-23       | DBV             | 5    | 3000 | 180.0       | 180.0      | 18.0        |
| LP2985-18DBVRG4 | SOT-23       | DBV             | 5    | 3000 | 180.0       | 180.0      | 18.0        |

| Device           | Package Type | Package Drawing | Pins | SPQ   | Length (mm) | Width (mm) | Height (mm) |
|------------------|--------------|-----------------|------|-------|-------------|------------|-------------|
| LP2985-18DBVTG4  | SOT-23       | DBV             | 5    | 250   | 180.0       | 180.0      | 18.0        |
| LP2985-25DBVR    | SOT-23       | DBV             | 5    | 3000  | 180.0       | 180.0      | 18.0        |
| LP2985-28DBVR    | SOT-23       | DBV             | 5    | 3000  | 180.0       | 180.0      | 18.0        |
| LP2985-28DBVTG4  | SOT-23       | DBV             | 5    | 250   | 180.0       | 180.0      | 18.0        |
| LP2985-29DBVR    | SOT-23       | DBV             | 5    | 3000  | 180.0       | 180.0      | 18.0        |
| LP2985-30DBVR    | SOT-23       | DBV             | 5    | 3000  | 180.0       | 180.0      | 18.0        |
| LP2985-33DBVR    | SOT-23       | DBV             | 5    | 3000  | 180.0       | 180.0      | 18.0        |
| LP2985-33DBVRG4  | SOT-23       | DBV             | 5    | 3000  | 180.0       | 180.0      | 18.0        |
| LP2985-33DBVT    | SOT-23       | DBV             | 5    | 250   | 180.0       | 180.0      | 18.0        |
| LP2985-33DBVTG4  | SOT-23       | DBV             | 5    | 250   | 180.0       | 180.0      | 18.0        |
| LP2985-50DBVR    | SOT-23       | DBV             | 5    | 3000  | 180.0       | 180.0      | 18.0        |
| LP2985A-10DBVR   | SOT-23       | DBV             | 5    | 3000  | 180.0       | 180.0      | 18.0        |
| LP2985A-10DBVT   | SOT-23       | DBV             | 5    | 250   | 180.0       | 180.0      | 18.0        |
| LP2985A-18DBVJ   | SOT-23       | DBV             | 5    | 10000 | 358.0       | 332.0      | 35.0        |
| LP2985A-18DBVR   | SOT-23       | DBV             | 5    | 3000  | 180.0       | 180.0      | 18.0        |
| LP2985A-18DBVRG4 | SOT-23       | DBV             | 5    | 3000  | 180.0       | 180.0      | 18.0        |
| LP2985A-25DBVR   | SOT-23       | DBV             | 5    | 3000  | 180.0       | 180.0      | 18.0        |
| LP2985A-25DBVT   | SOT-23       | DBV             | 5    | 250   | 205.0       | 200.0      | 33.0        |
| LP2985A-28DBVR   | SOT-23       | DBV             | 5    | 3000  | 180.0       | 180.0      | 18.0        |
| LP2985A-28DBVR   | SOT-23       | DBV             | 5    | 3000  | 205.0       | 200.0      | 33.0        |
| LP2985A-29DBVR   | SOT-23       | DBV             | 5    | 3000  | 180.0       | 180.0      | 18.0        |
| LP2985A-30DBVR   | SOT-23       | DBV             | 5    | 3000  | 180.0       | 180.0      | 18.0        |
| LP2985A-33DBVR   | SOT-23       | DBV             | 5    | 3000  | 180.0       | 180.0      | 18.0        |
| LP2985A-33DBVRG4 | SOT-23       | DBV             | 5    | 3000  | 180.0       | 180.0      | 18.0        |
| LP2985A-33DBVT   | SOT-23       | DBV             | 5    | 250   | 180.0       | 180.0      | 18.0        |
| LP2985A-33DBVTG4 | SOT-23       | DBV             | 5    | 250   | 180.0       | 180.0      | 18.0        |
| LP2985A-50DBVR   | SOT-23       | DBV             | 5    | 3000  | 180.0       | 180.0      | 18.0        |



# EXAMPLE BOARD LAYOUT

DBV0005A

SOT-23 - 1.45 mm max height

SMALL OUTLINE TRANSISTOR



LAND PATTERN EXAMPLE  
EXPOSED METAL SHOWN  
SCALE:15X



SOLDER MASK DETAILS

4214839/D 11/2018

NOTES: (continued)

- 5. Publication IPC-7351 may have alternate designs.
- 6. Solder mask tolerances between and around signal pads can vary based on board fabrication site.

# EXAMPLE STENCIL DESIGN

DBV0005A

SOT-23 - 1.45 mm max height

SMALL OUTLINE TRANSISTOR



SOLDER PASTE EXAMPLE  
BASED ON 0.125 mm THICK STENCIL  
SCALE:15X

4214839/D 11/2018

NOTES: (continued)

7. Laser cutting apertures with trapezoidal walls and rounded corners may offer better paste release. IPC-7525 may have alternate design recommendations.
8. Board assembly site may have different recommendations for stencil design.

## IMPORTANT NOTICE AND DISCLAIMER

TI PROVIDES TECHNICAL AND RELIABILITY DATA (INCLUDING DATASHEETS), DESIGN RESOURCES (INCLUDING REFERENCE DESIGNS), APPLICATION OR OTHER DESIGN ADVICE, WEB TOOLS, SAFETY INFORMATION, AND OTHER RESOURCES "AS IS" AND WITH ALL FAULTS, AND DISCLAIMS ALL WARRANTIES, EXPRESS AND IMPLIED, INCLUDING WITHOUT LIMITATION ANY IMPLIED WARRANTIES OF MERCHANTABILITY, FITNESS FOR A PARTICULAR PURPOSE OR NON-INFRINGEMENT OF THIRD PARTY INTELLECTUAL PROPERTY RIGHTS.

These resources are intended for skilled developers designing with TI products. You are solely responsible for (1) selecting the appropriate TI products for your application, (2) designing, validating and testing your application, and (3) ensuring your application meets applicable standards, and any other safety, security, or other requirements. These resources are subject to change without notice. TI grants you permission to use these resources only for development of an application that uses the TI products described in the resource. Other reproduction and display of these resources is prohibited. No license is granted to any other TI intellectual property right or to any third party intellectual property right. TI disclaims responsibility for, and you will fully indemnify TI and its representatives against, any claims, damages, costs, losses, and liabilities arising out of your use of these resources.

TI's products are provided subject to TI's Terms of Sale ([www.ti.com/legal/termsofsale.html](http://www.ti.com/legal/termsofsale.html)) or other applicable terms available either on [ti.com](http://ti.com) or provided in conjunction with such TI products. TI's provision of these resources does not expand or otherwise alter TI's applicable warranties or warranty disclaimers for TI products.

Mailing Address: Texas Instruments, Post Office Box 655303, Dallas, Texas 75265  
Copyright © 2019, Texas Instruments Incorporated

## Looking for pricing, stock, or lifecycle information?

Click below to explore more details on WIN SOURCE:

 [View LP2985A-33DBVTG4](#) on WIN SOURCE

 [Texas Instruments](#) Information

## Optimize Your Supply Chain with WIN SOURCE Solutions

-  Global Sourcing Solution
-  Obsolete Management
-  Cost Control Management
-  Shortage Management
-  Alternative Solution
-  Excess Inventory Management