



**THE DATASHEET OF
LXES1UBBB1-008**



1. Application

- ESD Protection

2. Features

- Bi-directional device
- IEC61000-4-2(ESD) $\pm 15\text{kV}$ (air), $\pm 8\text{kV}$ (contact)
- Fast Turn on and Low Clamping voltage
- Ultra-low capacitance 0.5pF typical
- RoHS regulation conformity parts
-

3. Dimensions (Unit :mm)

TOP VIEW

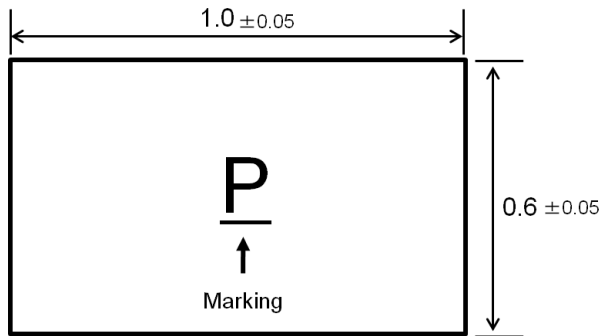

BOTTOM VIEW

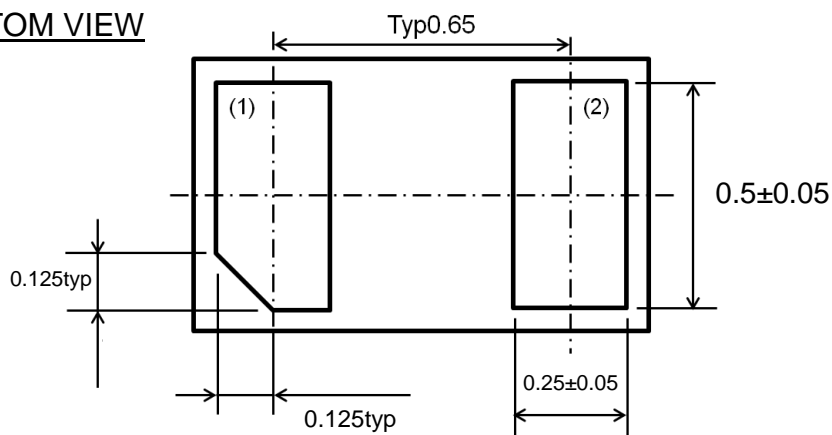

SIDE VIEW



4. Schematic

BOTTOM VIEW

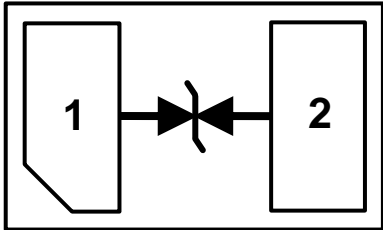

5. Maximum Ratings

Rating	Symbol	Value	Unit
Operating Voltage	V_{DC}	± 6	V
ESD per IEC 61000-4-2 (air)	V_{ESD}	± 15	kV
ESD per IEC 61000-4-2 (contact)		± 8	
Lead Soldering Temperature	T_{SOL}	260 (10 sec.)	$^{\circ}C$
Operating Temperature	T_{OP}	-40 to +85	$^{\circ}C$
Storage Temperature	T_{STO}	-40 to +125	$^{\circ}C$

6. Electrical Characteristics (T=25 $^{\circ}C$)

Parameter	Symbol	Conditions	MIN	TYP	MAX	Units
Leakage Current	I_{Leak}	$V_{RWM} = \pm 5V$			1	μA
Breakdown Voltage	V_{BV}	$I_{BV} = 1mA$	7			V
Capacitance (I/O - GND)	C_{IN}	$V_R = 0V, f = 1MHz$		0.5		pF

7. Typical Characteristic

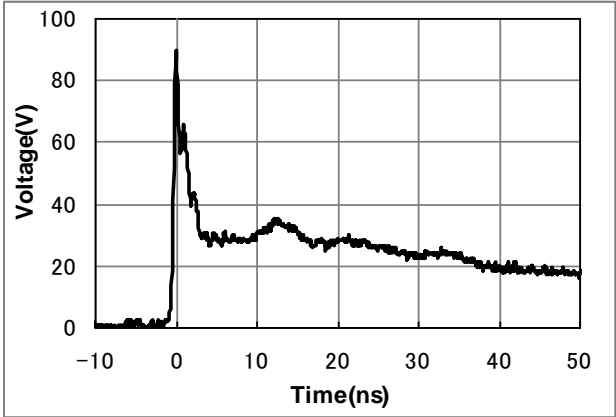

ESD Waveform (IEC61000-4-2:8kV Contact)

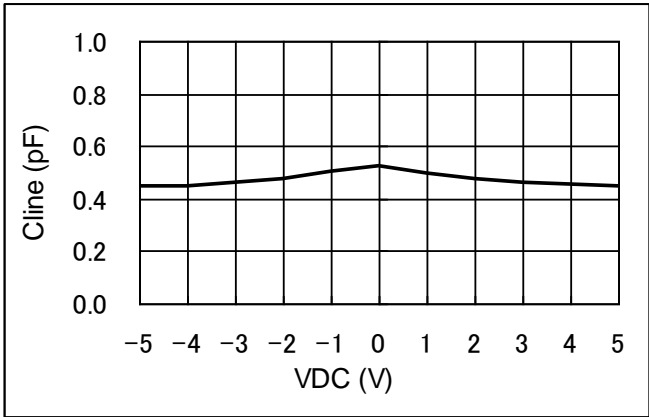

Voltage vs. Capacitance

8. Soldering Footprint (Unit :mm)

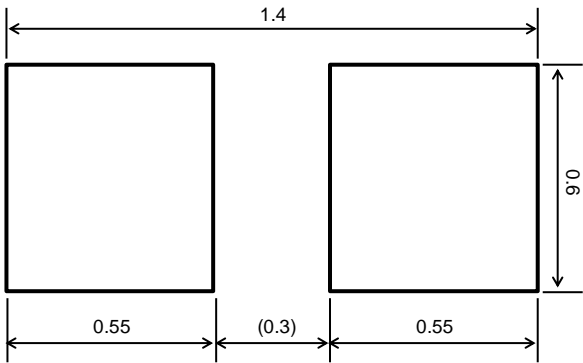

Note: This footprint is for reference purpose only.

9. Taping Specification

1) Dimensions of Tape (Plastic tape)

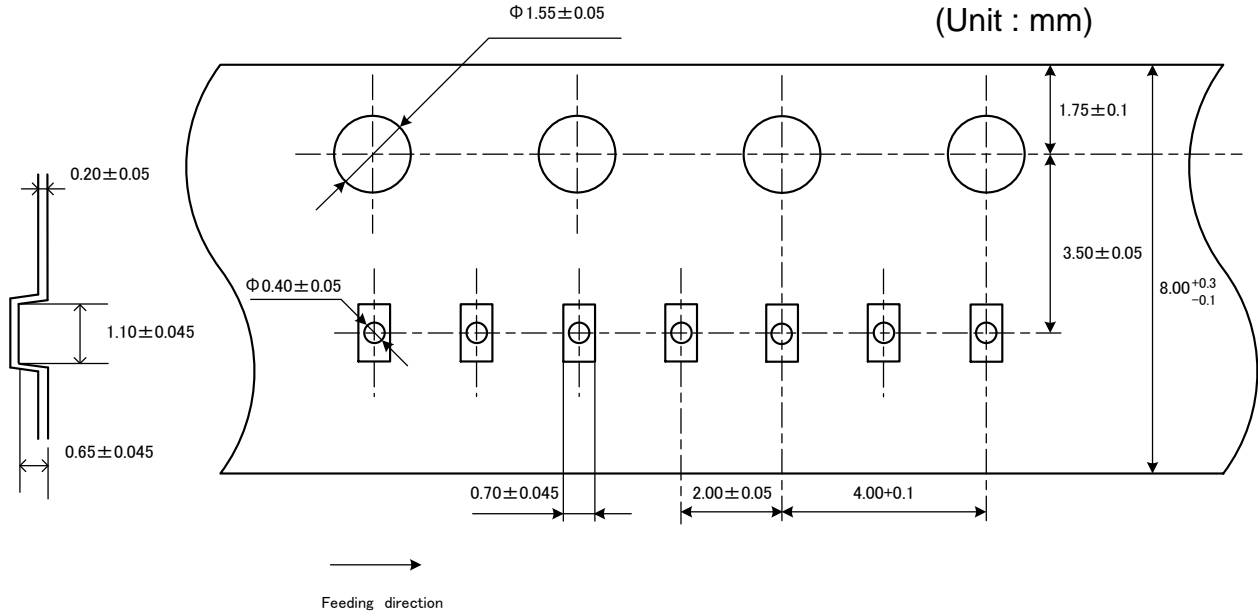

2) Dimensions of Reel

(Unit : mm)

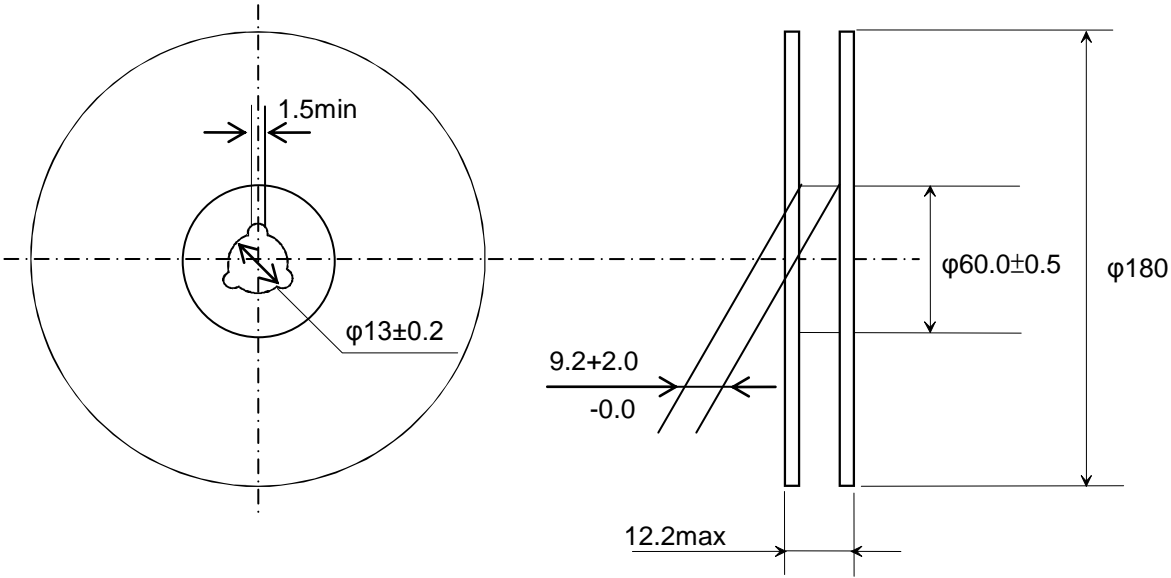



3) Packaging unit: 3,000 pcs / reel

Note:

1. This datasheet's specifications are subject to change or our products in it may be discontinued without advance notice. Please check with our sales representatives or product engineers before ordering.
2. This datasheet has only typical specifications because there is no space for detailed specifications. Therefore, please approve our product specifications or transact the approval sheet for product specifications before ordering.

Looking for pricing, stock, or lifecycle information?

Click below to explore more details on WIN SOURCE:

-  [View LXES1UBBB1-008 on WIN SOURCE](#)
-  [Murata Electronics North America Information](#)

Optimize Your Supply Chain with WIN SOURCE Solutions

-  Global Sourcing Solution
-  Obsolete Management
-  Cost Control Management
-  Shortage Management
-  Alternative Solution
-  Excess Inventory Management