

TrenchMV™ Power MOSFET

IXTP64N055T IXTY64N055T

$$V_{DSS} = 55 \text{ V}$$

$$I_{D25} = 64 \text{ A}$$

$$R_{DS(on)} \leq 13 \text{ m}\Omega$$

N-Channel Enhancement Mode
Avalanche Rated

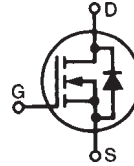

TO-220 (IXTP)

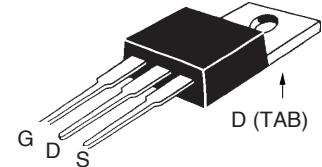

TO-252 (IXTY)

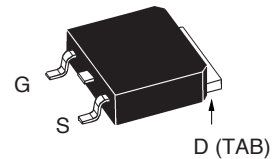

G = Gate D = Drain
S = Source TAB = Drain

Symbol	Test Conditions	Maximum Ratings	
V_{DSS}	$T_J = 25^\circ\text{C}$ to 175°C	55	V
V_{DGR}	$T_J = 25^\circ\text{C}$ to 175°C ; $R_{GS} = 1 \text{ M}\Omega$	55	V
V_{GSM}	Transient	± 20	V
I_{D25}	$T_C = 25^\circ\text{C}$	64	A
I_L	Package Current Limit, RMS TO-252	25	A
I_{DM}	$T_C = 25^\circ\text{C}$, pulse width limited by T_{JM}	170	A
I_{AR}	$T_C = 25^\circ\text{C}$	10	A
E_{AS}	$T_C = 25^\circ\text{C}$	250	mJ
dv/dt	$I_S \leq I_{DM}$, $di/dt \leq 100 \text{ A}/\mu\text{s}$, $V_{DD} \leq V_{DSS}$ $T_J \leq 175^\circ\text{C}$, $R_G = 18 \Omega$	3	V/ns
P_D	$T_C = 25^\circ\text{C}$	130	W
T_J		-55 ... +175	$^\circ\text{C}$
T_{JM}		175	$^\circ\text{C}$
T_{stg}		-55 ... +175	$^\circ\text{C}$
T_L	1.6 mm (0.062 in.) from case for 10 s	300	$^\circ\text{C}$
T_{SOLD}	Plastic body for 10 seconds	260	$^\circ\text{C}$
M_d	Mounting torque (TO-220)	1.13 / 10	Nm/lb.in.
Weight	TO-220	3	g
	TO-252	0.35	g

Features

- Ultra-low On Resistance
- Unclamped Inductive Switching (UIS) rated
- Low package inductance
 - easy to drive and to protect
- 175°C Operating Temperature

Advantages

- Easy to mount
- Space savings
- High power density

Applications

- Automotive
 - Motor Drives
 - High Side Switch
 - 12V Battery
 - ABS Systems
- DC/DC Converters and Off-line UPS
- Primary- Side Switch
- High Current Switching Applications

Symbol	Test Conditions ($T_J = 25^\circ\text{C}$ unless otherwise specified)	Characteristic Values		
		Min.	Typ.	Max.
BV_{DSS}	$V_{GS} = 0 \text{ V}$, $I_D = 250 \mu\text{A}$	55		V
$V_{GS(th)}$	$V_{DS} = V_{GS}$, $I_D = 25 \mu\text{A}$	2.0		4.0 V
I_{GSS}	$V_{GS} = \pm 20 \text{ V}$, $V_{DS} = 0 \text{ V}$			$\pm 100 \text{ nA}$
I_{DSS}	$V_{DS} = V_{DSS}$			1 μA
	$V_{GS} = 0 \text{ V}$ $T_J = 150^\circ\text{C}$			100 μA
$R_{DS(on)}$	$V_{GS} = 10 \text{ V}$, $I_D = 0.5 I_{D25}$, Notes 1, 2			13 $\text{m}\Omega$

Symbol	Test Conditions ($T_J = 25^\circ\text{C}$ unless otherwise specified)	Characteristic Values		
		Min.	Typ.	Max.
g_{fs}	$V_{DS} = 10\text{ V}; I_D = 0.5 I_{D25}$, Note 1	17	28	S
C_{iss}			1420	pF
C_{oss}	$V_{GS} = 0\text{ V}, V_{DS} = 25\text{ V}, f = 1\text{ MHz}$		255	pF
C_{rss}			68	pF
$t_{d(on)}$			19	ns
t_r	$V_{GS} = 10\text{ V}, V_{DS} = 0.5 V_{DSS}, I_D = 10\text{ A}$		52	ns
$t_{d(off)}$	$R_G = 18\Omega$ (External)		37	ns
t_f			30	ns
$Q_{g(on)}$			37	nC
Q_{gs}	$V_{GS} = 10\text{ V}, V_{DS} = 0.5 V_{DSS}, I_D = 10\text{ A}$		10	nC
Q_{gd}			11	nC
R_{thJC}				1.15°C/W
R_{thCS}	TO-220	0.5		$^\circ\text{C/W}$

Source-Drain Diode

Symbol	Test Conditions	Characteristic Values		
		Min.	Typ.	Max.
I_S	$V_{GS} = 0\text{ V}$			64 A
I_{SM}	Repetitive			170 A
V_{SD}	$I_F = 25\text{ A}, V_{GS} = 0\text{ V}$, Note 1			1.2 V
t_{rr}	$I_F = 25\text{ A}, -di/dt = 100\text{ A}/\mu\text{s}$ $V_R = 30\text{ V}, V_{GS} = 0\text{ V}$		30	ns

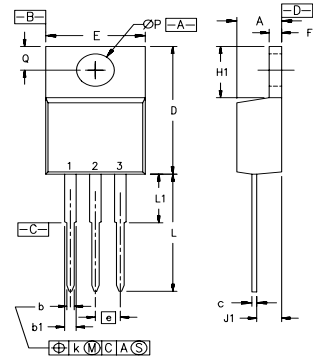
TO-220 (IXTP) Outline

Pins: 1 - Gate 2 - Drain
3 - Source 4, TAB - Drain

SYM	INCHES		MILLIMETERS	
	MIN	MAX	MIN	MAX
A	.170	.190	4.32	4.83
b	.025	.040	0.64	1.02
b1	.045	.065	1.15	1.65
c	.014	.022	0.35	0.56
D	.580	.630	14.73	16.00
E	.390	.420	9.91	10.66
e	.100 BSC		2.54 BSC	
F	.045	.055	1.14	1.40
H1	.230	.270	5.85	6.85
J1	.090	.110	2.29	2.79
k	0	.015	0	0.38
L	.500	.550	12.70	13.97
L1	.110	.230	2.79	5.84
$\varnothing P$.139	.161	3.53	4.08
Q	.100	.125	2.54	3.18

Notes:

- Pulse test: $t \leq 300\ \mu\text{s}$, duty cycle $d \leq 2\%$;
- On through-hole packages, $R_{DS(on)}$ Kelvin test contact location must be 5 mm or less from the package body.

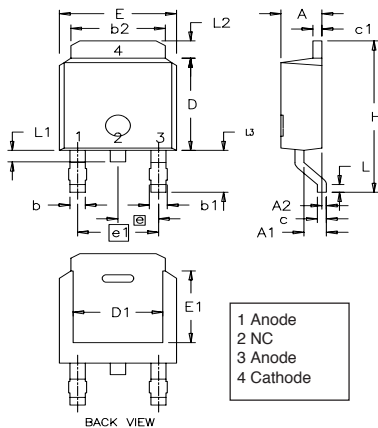
TO-252 (IXTY) Outline

1 Anode
2 NC
3 Anode
4 Cathode

Dim.	Millimeter		Inches	
	Min.	Max.	Min.	Max.
A	2.19	2.38	0.086	0.094
A1	0.89	1.14	0.035	0.045
A2	0	0.13	0	0.005
b	0.64	0.89	0.025	0.035
b1	0.76	1.14	0.030	0.045
b2	5.21	5.46	0.205	0.215
c	0.46	0.58	0.018	0.023
c1	0.46	0.58	0.018	0.023
D	5.97	6.22	0.235	0.245
D1	4.32	5.21	0.170	0.205
E	6.35	6.73	0.250	0.265
E1	4.32	5.21	0.170	0.205
e	2.28 BSC		0.090 BSC	
e1	4.57 BSC		0.180 BSC	
H	9.40	10.42	0.370	0.410
L	0.51	1.02	0.020	0.040
L1	0.64	1.02	0.025	0.040
L2	0.89	1.27	0.035	0.050
L3	2.54	2.92	0.100	0.115

PRELIMINARY TECHNICAL INFORMATION

The product presented herein is under development. The Technical Specifications offered are derived from data gathered during objective characterizations of preliminary engineering lots; but also may yet contain some information supplied during a pre-production design evaluation. IXYS reserves the right to change limits, test conditions, and dimensions without notice.

IXYS reserves the right to change limits, test conditions, and dimensions.

IXYS MOSFETs and IGBTs are covered by one or more of the following U.S. patents:	4,835,592	4,931,844	5,049,961	5,237,481	6,162,665	6,404,065 B1	6,683,344	6,727,585	7,005,734 B2
	4,850,072	5,017,508	5,063,307	5,381,025	6,259,123 B1	6,534,343	6,710,405 B2	6,759,692	7,063,975 B2
	4,881,106	5,034,796	5,187,117	5,486,715	6,306,728 B1	6,583,505	6,710,463	6,771,478 B2	7,071,537

**Fig. 1. Output Characteristics
@ 25°C**

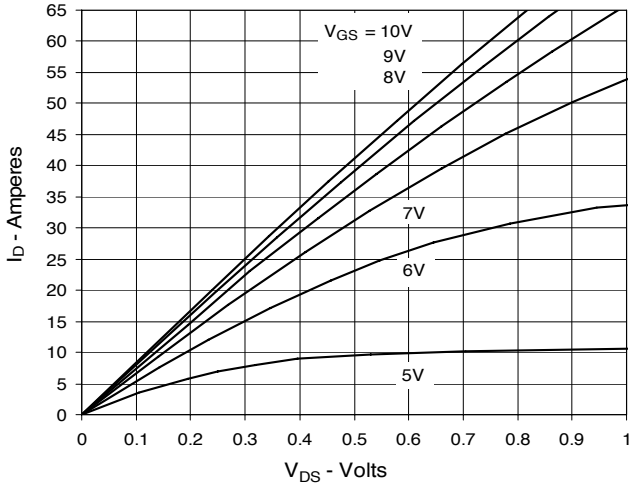

**Fig. 2. Extended Output Characteristics
@ 25°C**

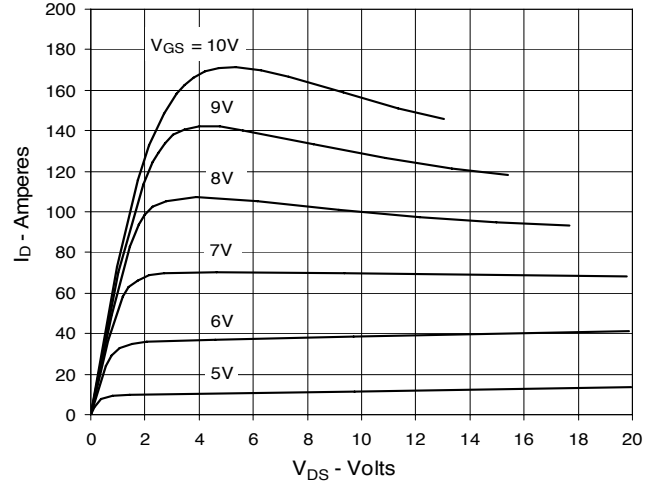

**Fig. 3. Output Characteristics
@ 150°C**

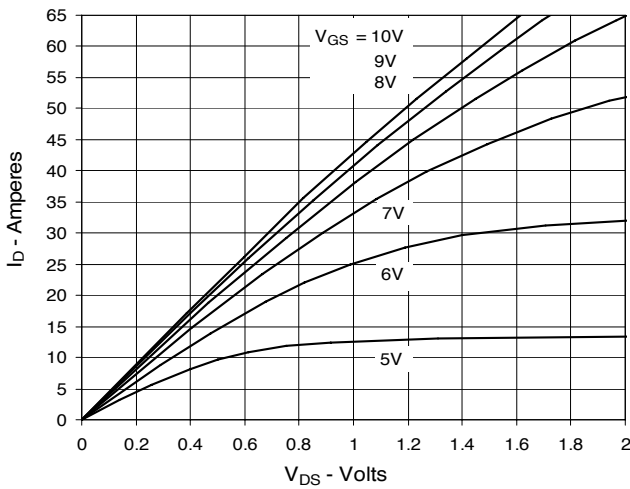

**Fig. 4. $R_{DS(on)}$ Normalized to $I_D = 32A$ Value
vs. Junction Temperature**

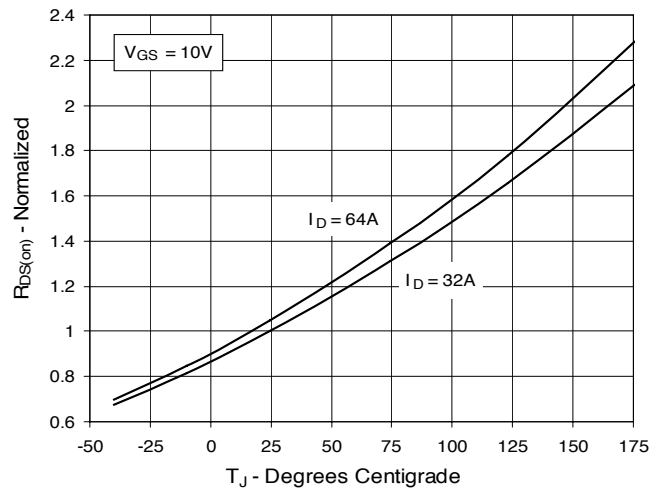

**Fig. 5. $R_{DS(on)}$ Normalized to $I_D = 32A$ Value
vs. Drain Current**

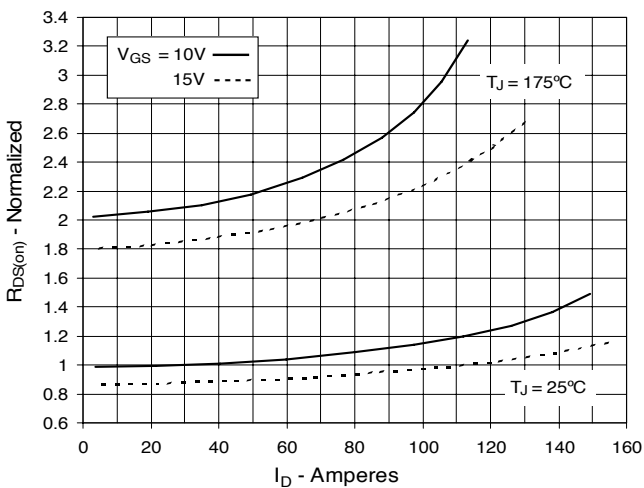

**Fig. 6. Maximum Drain Current vs.
Case Temperature**

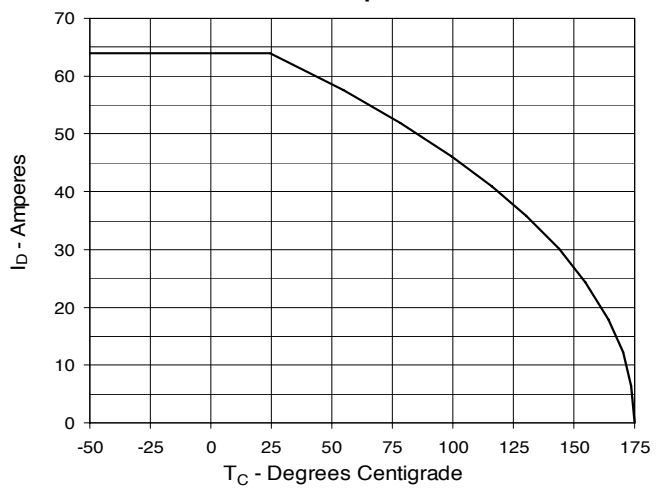

Fig. 7. Input Admittance

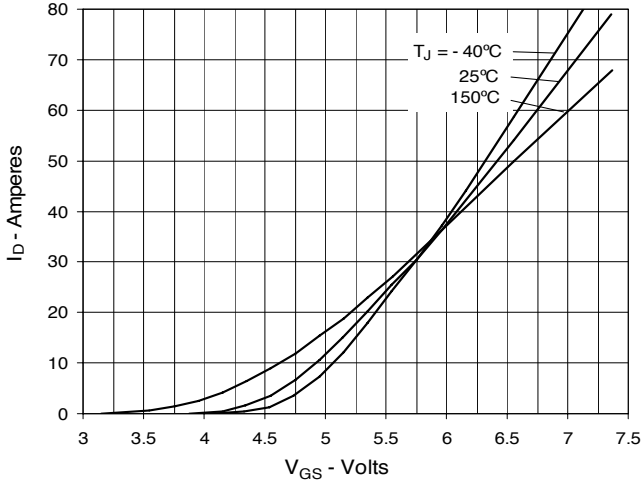

Fig. 8. Transconductance

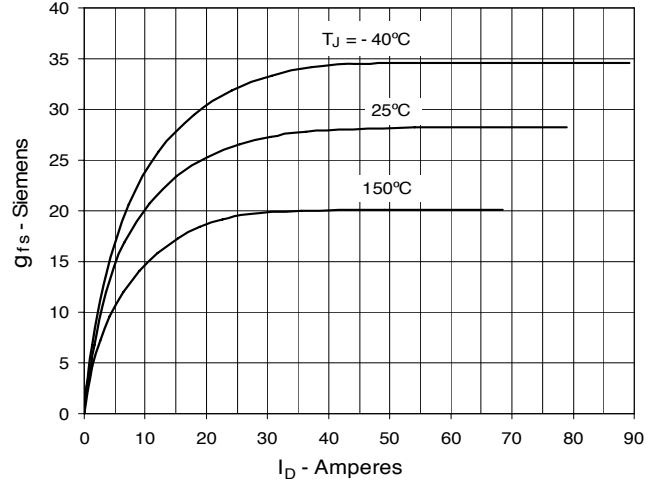

Fig. 9. Forward Voltage Drop of Intrinsic Diode

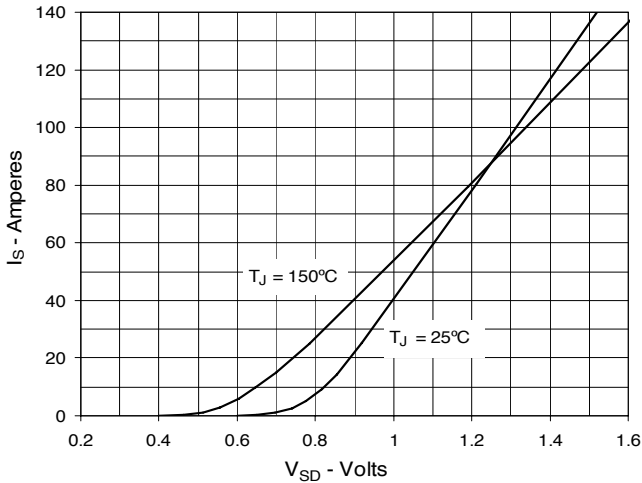

Fig. 10. Gate Charge

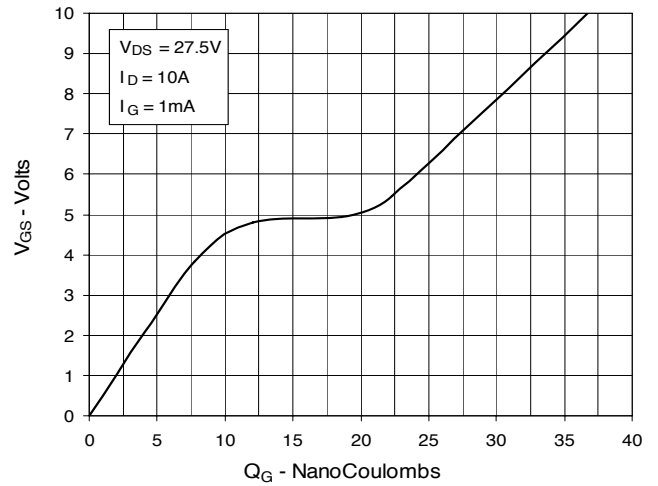

Fig. 11. Capacitance

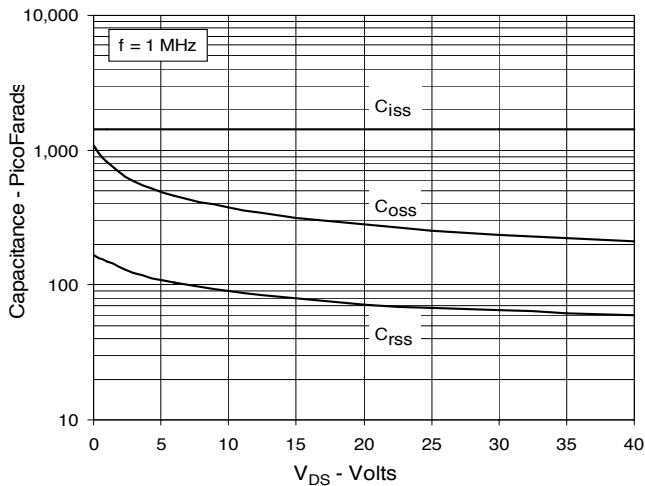
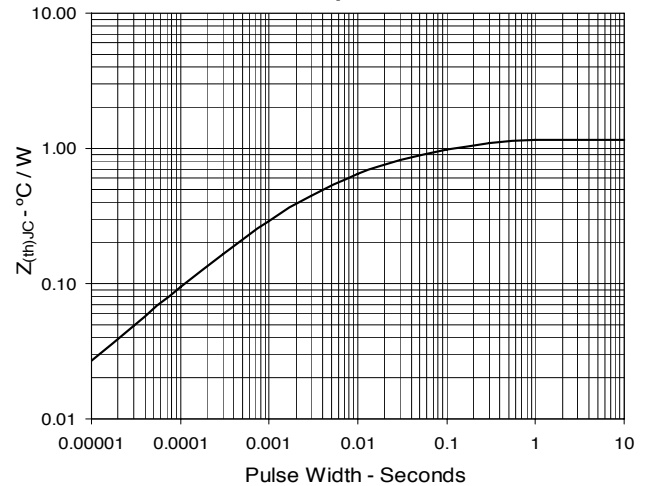
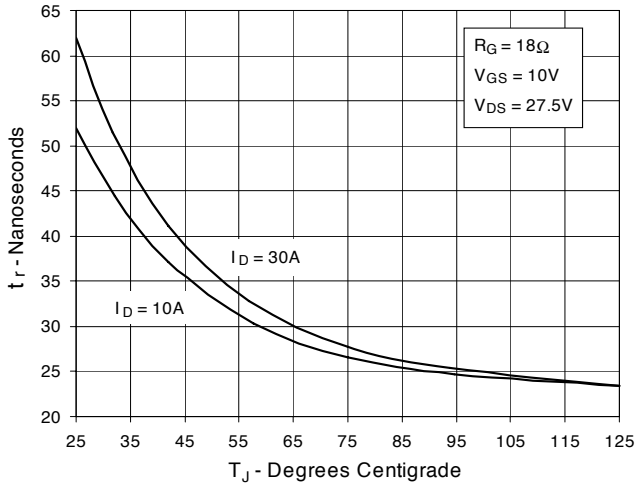

Fig. 12. Maximum Transient Thermal Impedance



**Fig. 13. Resistive Turn-on
Rise Time vs. Junction Temperature**



**Fig. 14. Resistive Turn-on
Rise Time vs. Drain Current**

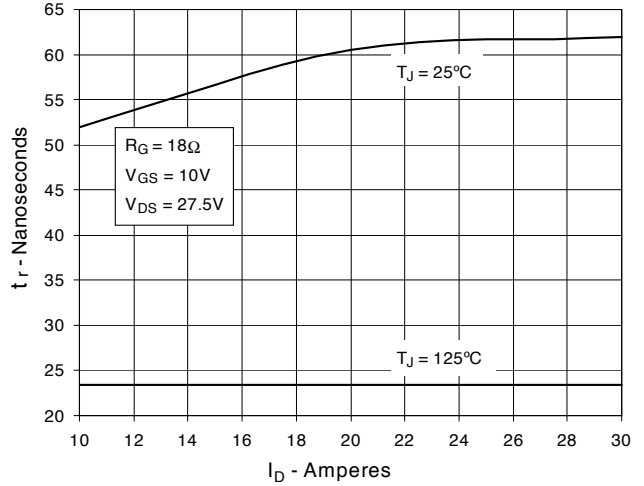

**Fig. 15. Resistive Turn-on
Switching Times vs. Gate Resistance**

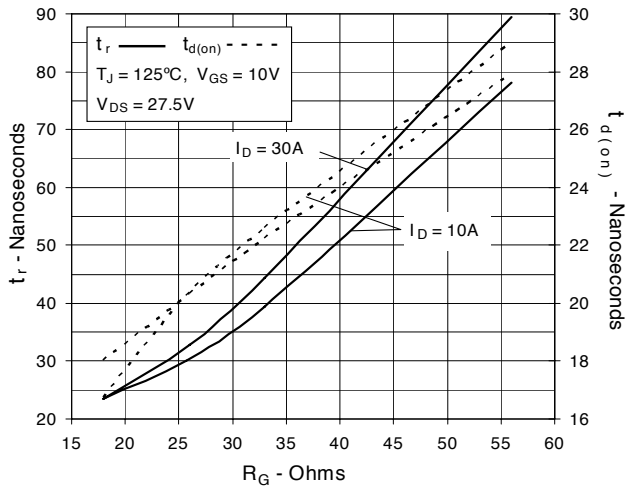

**Fig. 16. Resistive Turn-off
Switching Times vs. Junction Temperature**

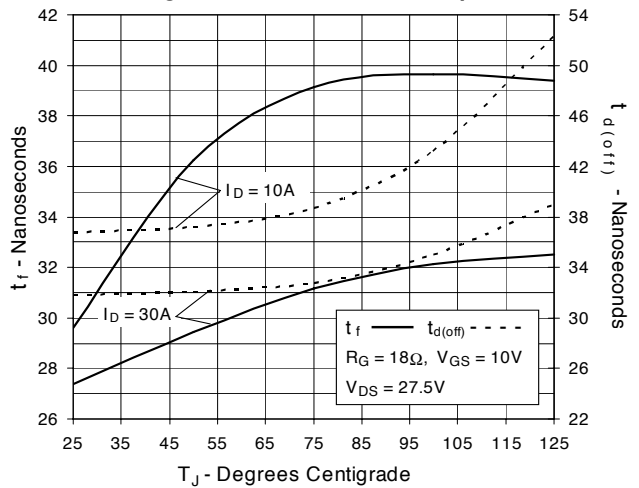

**Fig. 17. Resistive Turn-off
Switching Times vs. Drain Current**

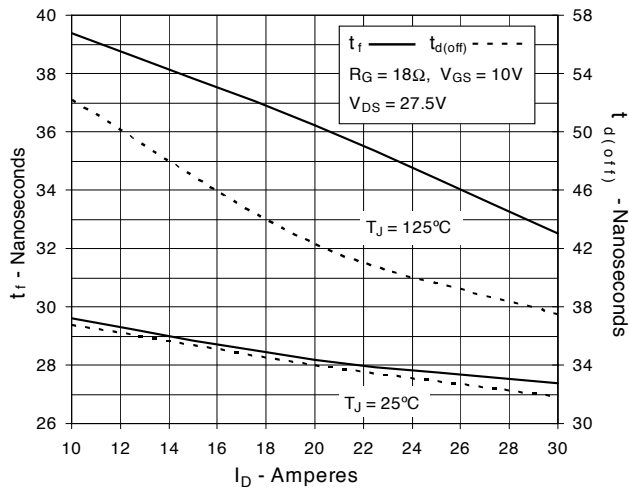

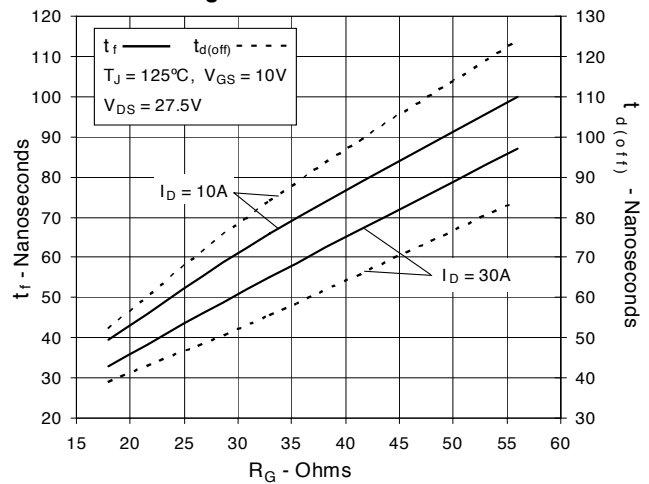

**Fig. 18. Resistive Turn-off
Switching Times vs. Gate Resistance**









Looking for pricing, stock, or lifecycle information?

Click below to explore more details on WIN SOURCE:

-  [View IXTP64N055T on WIN SOURCE](#)
-  [IXYS Information](#)

Optimize Your Supply Chain with WIN SOURCE Solutions

-  Global Sourcing Solution
-  Obsolete Management
-  Cost Control Management
-  Shortage Management
-  Alternative Solution
-  Excess Inventory Management