



**THE DATASHEET OF
AOTF20C60PL**





General Description

- Trench Power AlphaMOS-II technology
- Low $R_{DS(ON)}$
- Low C_{iss} and C_{rss}
- High Current Capability

Applications

- General Lighting for LED and CCFL
- AC/DC Power supplies for Industrial, Consumer, and Telecom

Product Summary

$V_{DS} @ T_{j,max}$	700V
I_{DM}	80A
$R_{DS(ON),max}$	< 0.25 Ω
$Q_{g,typ}$	52nC
$E_{oss} @ 400V$	8.2 μ J

100% UIS Tested
100% R_g Tested

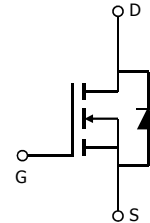
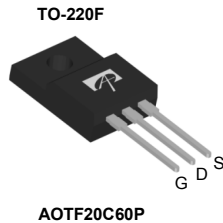

Orderable Part Number	Package Type	Form	Minimum Order Quantity
AOTF20C60P	TO-220F Pb Free	Tube	1000
AOTF20C60PL	TO-220F Green	Tube	1000

Absolute Maximum Ratings $T_A=25^\circ\text{C}$ unless otherwise noted

Parameter	Symbol	AOTF20C60P	AOTF20C60PL	Units
Drain-Source Voltage	V_{DS}	600		V
Gate-Source Voltage	V_{GS}	± 30		V
Continuous Drain Current	I_D	$T_C=25^\circ\text{C}$	20*	A
		$T_C=100^\circ\text{C}$	16*	
Pulsed Drain Current ^C	I_{DM}	80		
Avalanche Current ^C L=1mH	I_{AR}	20		A
Repetitive avalanche energy ^C	E_{AR}	200		mJ
Single pulsed avalanche energy ^G	E_{AS}	1599		mJ
MOSFET dv/dt ruggedness	dv/dt	100		V/ns
Peak diode recovery dv/dt		20		
Power Dissipation ^B	P_D	$T_C=25^\circ\text{C}$	50	W
		Derate above 25 $^\circ\text{C}$	0.4	
Junction and Storage Temperature Range	T_J, T_{STG}	-55 to 150		$^\circ\text{C}$
Maximum lead temperature for soldering purpose, 1/8" from case for 5 seconds	T_L	300		$^\circ\text{C}$

Thermal Characteristics

Parameter	Symbol	AOTF20C60P	AOTF20C60PL	Units
Maximum Junction-to-Ambient ^{A,D}	$R_{\theta JA}$	65	65	$^\circ\text{C}/\text{W}$
Maximum Junction-to-Case	$R_{\theta JC}$	2.5	2.8	$^\circ\text{C}/\text{W}$

* Drain current limited by maximum junction temperature.

Electrical Characteristics (T_J=25°C unless otherwise noted)

Symbol	Parameter	Conditions	Min	Typ	Max	Units
STATIC PARAMETERS						
BV _{DSS}	Drain-Source Breakdown Voltage	I _D =250μA, V _{GS} =0V, T _J =25°C	600			V
		I _D =250μA, V _{GS} =0V, T _J =150°C		700		
BV _{DSS} /ΔT _J	Breakdown Voltage Temperature Coefficient	I _D =250μA, V _{GS} =0V		0.54		V/°C
I _{DSS}	Zero Gate Voltage Drain Current	V _{DS} =600V, V _{GS} =0V			1	μA
		V _{DS} =480V, T _J =125°C			10	
I _{GSS}	Gate-Body leakage current	V _{DS} =0V, V _{GS} =±30V			±100	nA
V _{GS(th)}	Gate Threshold Voltage	V _{DS} =5V, I _D =250μA	3	3.8	5	V
R _{DS(ON)}	Static Drain-Source On-Resistance	V _{GS} =10V, I _D =10A		0.215	0.25	Ω
g _{FS}	Forward Transconductance	V _{DS} =40V, I _D =10A		20		S
V _{SD}	Diode Forward Voltage	I _S =1A, V _{GS} =0V		0.7	1	V
I _S	Maximum Body-Diode Continuous Current				20	A
I _{SM}	Maximum Body-Diode Pulsed Current ^C				80	A
DYNAMIC PARAMETERS						
C _{iss}	Input Capacitance	V _{GS} =0V, V _{DS} =100V, f=1MHz		3607		pF
C _{oss}	Output Capacitance				140	
C _{o(er)}	Effective output capacitance, energy related ^H	V _{GS} =0V, V _{DS} =0 to 480V, f=1MHz		95		pF
C _{o(tr)}	Effective output capacitance, time related ^I				182	
C _{rss}	Reverse Transfer Capacitance	V _{GS} =0V, V _{DS} =100V, f=1MHz		3.3		pF
R _g	Gate resistance	f=1MHz		2		Ω
SWITCHING PARAMETERS						
Q _g	Total Gate Charge	V _{GS} =10V, V _{DS} =480V, I _D =20A		52	80	nC
Q _{gs}	Gate Source Charge			20		nC
Q _{gd}	Gate Drain Charge			14		nC
t _{D(on)}	Turn-On DelayTime	V _{GS} =10V, V _{DS} =300V, I _D =20A, R _G =25Ω		77		ns
t _r	Turn-On Rise Time			67		ns
t _{D(off)}	Turn-Off DelayTime			120		ns
t _f	Turn-Off Fall Time			43		ns
t _{rr}	Body Diode Reverse Recovery Time	I _F =20A, dI/dt=100A/μs, V _{DS} =100V		599		ns
Q _{rr}	Body Diode Reverse Recovery Charge	I _F =20A, dI/dt=100A/μs, V _{DS} =100V		11		μC

A. The value of R_{θJA} is measured with the device in a still air environment with T_A=25°C.

B. The power dissipation P_D is based on T_{J(MAX)}=150°C, using junction-to-case thermal resistance, and is more useful in setting the upper dissipation limit for cases where additional heatsinking is used.

C. Repetitive rating, pulse width limited by junction temperature T_{J(MAX)}=150°C. Ratings are based on low frequency and duty cycles to keep initial T_J=25°C.

D. The R_{θJA} is the sum of the thermal impedance from junction to case R_{θJC} and case to ambient.

E. The static characteristics in Figures 1 to 6 are obtained using <300μs pulses, duty cycle 0.5% max.

F. These curves are based on the junction-to-case thermal impedance which is measured with the device mounted to a large heatsink, assuming a maximum junction temperature of T_{J(MAX)}=150°C. The SOA curve provides a single pulse rating.

G. L=60mH, I_{AS}=7.3A, V_{DD}=150V, R_G=25Ω, Starting T_J=25°C.

H. C_{o(er)} is a fixed capacitance that gives the same stored energy as C_{oss} while V_{DS} is rising from 0 to 80% V_{(BR)DSS}.

I. C_{o(tr)} is a fixed capacitance that gives the same charging time as C_{oss} while V_{DS} is rising from 0 to 80% V_{(BR)DSS}.

THIS PRODUCT HAS BEEN DESIGNED AND QUALIFIED FOR THE CONSUMER MARKET. APPLICATIONS OR USES AS CRITICAL COMPONENTS IN LIFE SUPPORT DEVICES OR SYSTEMS ARE NOT AUTHORIZED. AOS DOES NOT ASSUME ANY LIABILITY ARISING OUT OF SUCH APPLICATIONS OR USES OF ITS PRODUCTS. AOS RESERVES THE RIGHT TO IMPROVE PRODUCT DESIGN, FUNCTIONS AND RELIABILITY WITHOUT NOTICE.

TYPICAL ELECTRICAL AND THERMAL CHARACTERISTICS

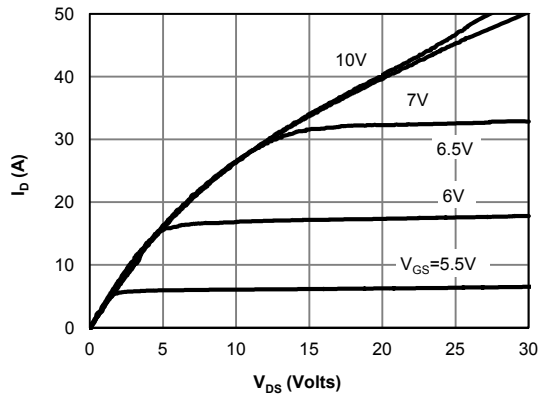

Figure 1: On-Region Characteristics

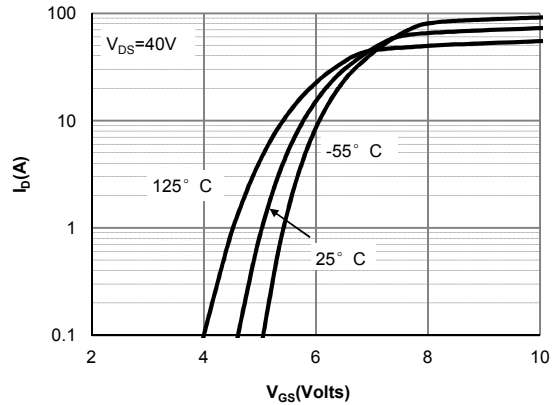

Figure 2: Transfer Characteristics

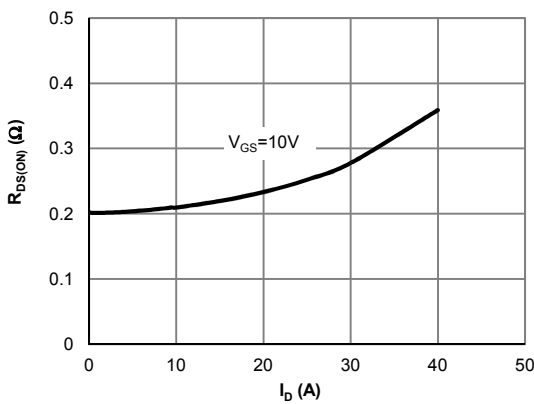

Figure 3: On-Resistance vs. Drain Current and Gate Voltage

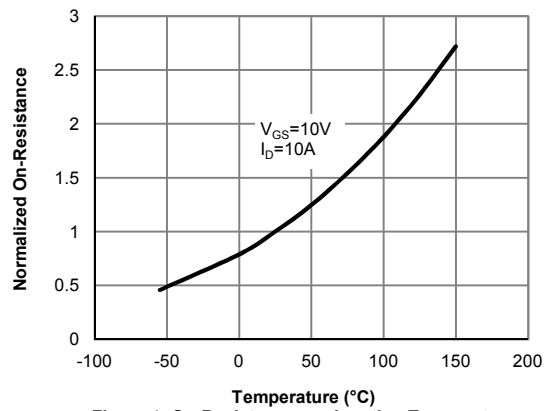

Figure 4: On-Resistance vs. Junction Temperature

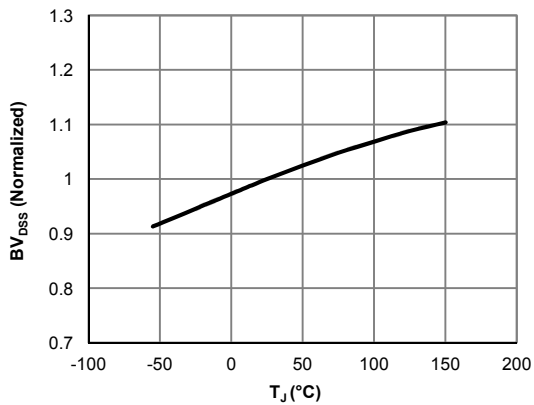

Figure 5: Break Down vs. Junction Temperature

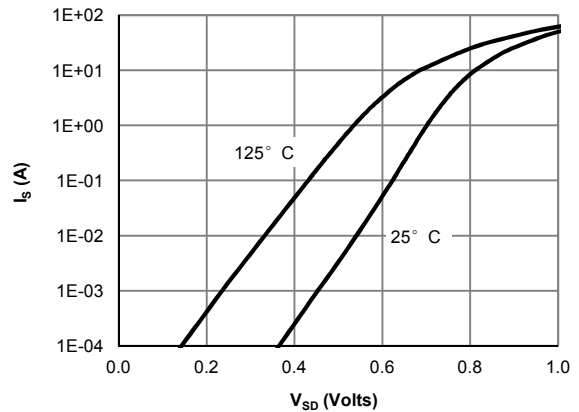

Figure 6: Body-Diode Characteristics

TYPICAL ELECTRICAL AND THERMAL CHARACTERISTICS

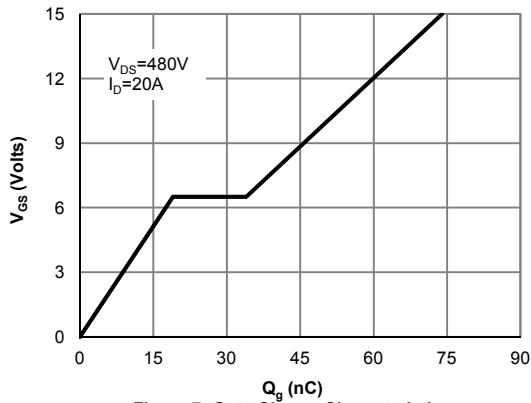

Figure 7: Gate-Charge Characteristics

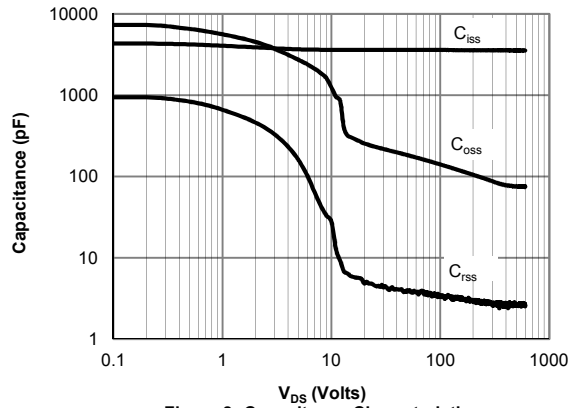

Figure 8: Capacitance Characteristics

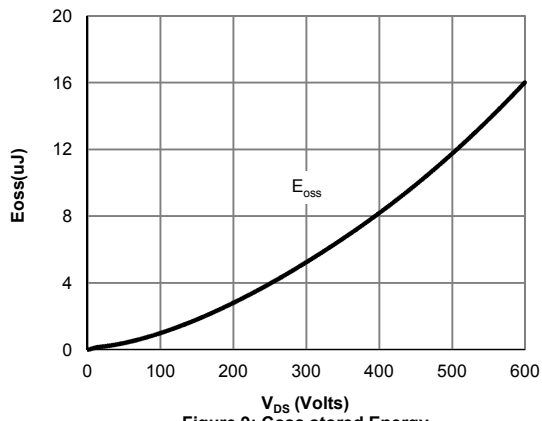

Figure 9: Coss stored Energy

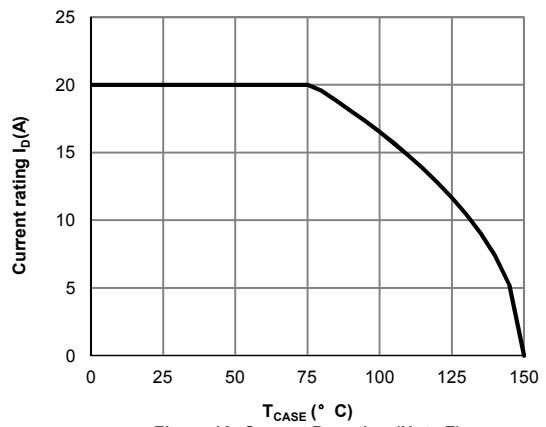

Figure 10: Current De-rating (Note F)

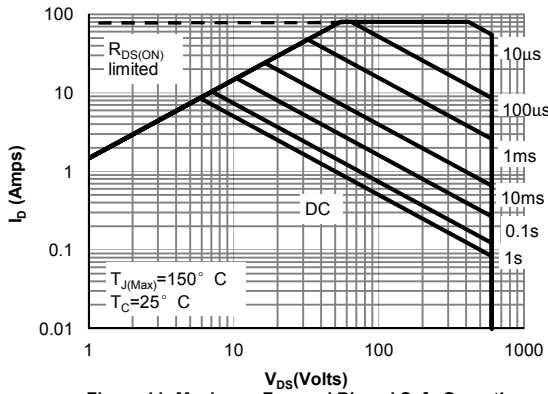

Figure 11: Maximum Forward Biased Safe Operating Area for TO-220F Pb Free (Note F)

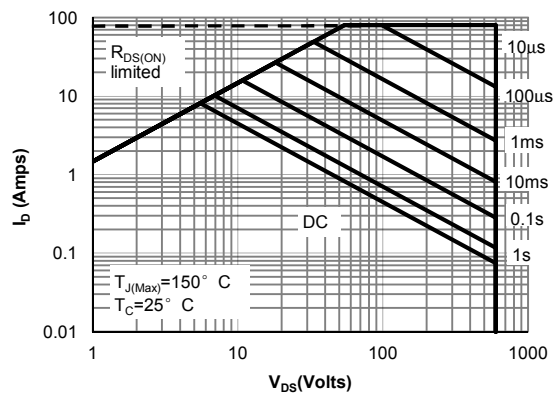

Figure 12: Maximum Forward Biased Safe Operating Area for TO-220F Green (Note F)

TYPICAL ELECTRICAL AND THERMAL CHARACTERISTICS

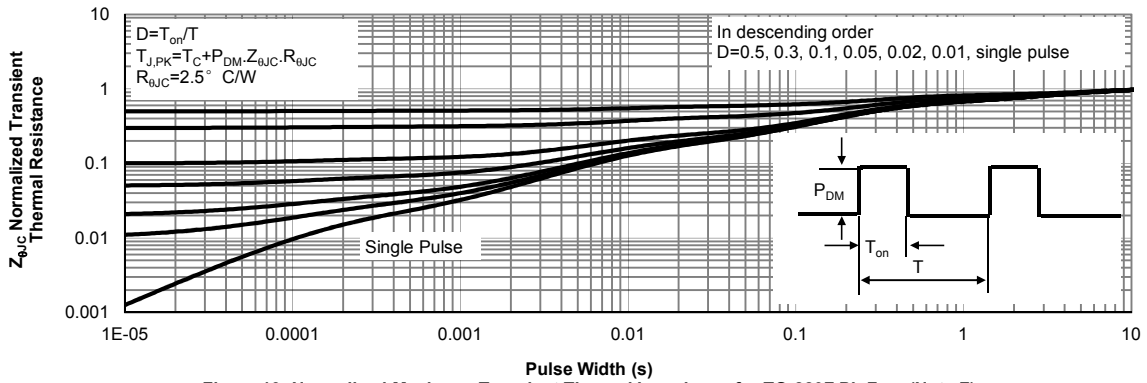

Figure 13: Normalized Maximum Transient Thermal Impedance for TO-220F Pb Free (Note F)

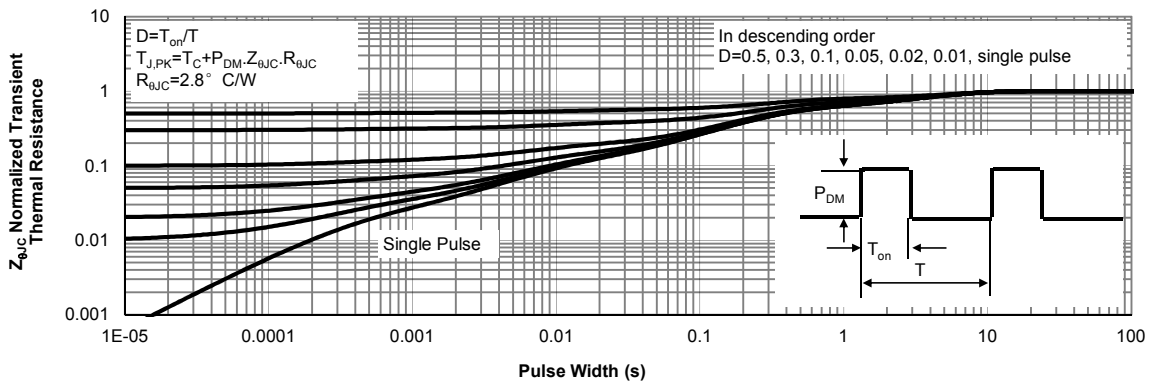
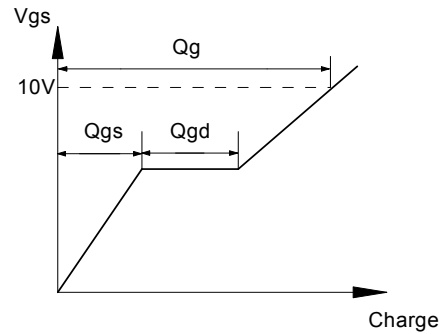
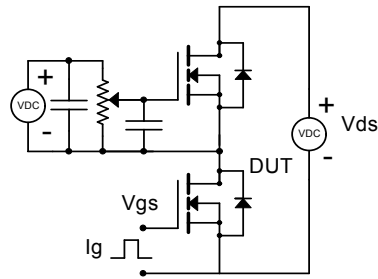
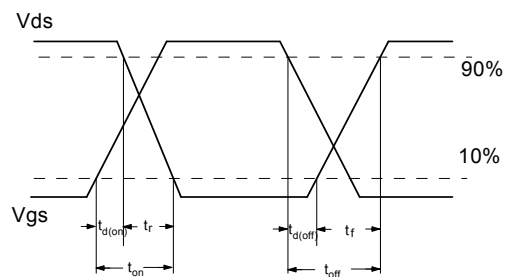
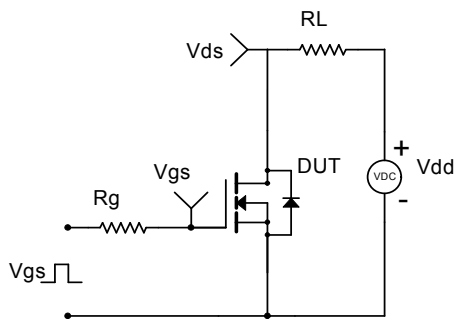

Figure 14: Normalized Maximum Transient Thermal Impedance for TO-220F Green (Note F)

Gate Charge Test Circuit & Waveform



Resistive Switching Test Circuit & Waveforms



Unclamped Inductive Switching (UIS) Test Circuit & Waveforms

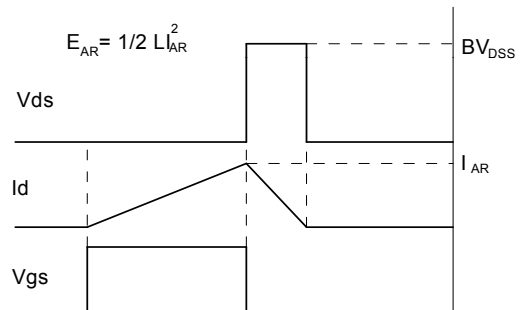
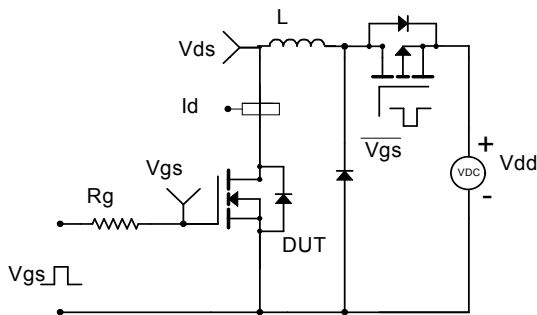

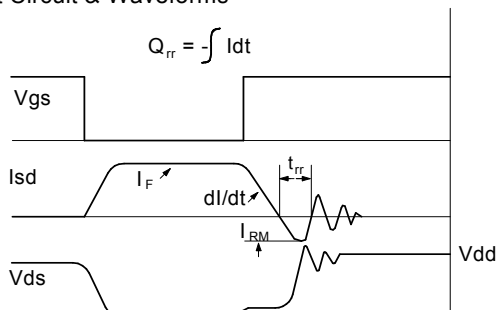
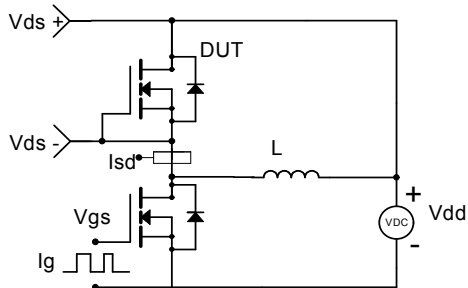

Diode Recovery Test Circuit & Waveforms



Looking for pricing, stock, or lifecycle information?

Click below to explore more details on WIN SOURCE:

-  [View AOTF20C60PL on WIN SOURCE](#)
-  [Alpha & Omega Semiconductor Inc. Information](#)

Optimize Your Supply Chain with WIN SOURCE Solutions

-  Global Sourcing Solution
-  Obsolete Management
-  Cost Control Management
-  Shortage Management
-  Alternative Solution
-  Excess Inventory Management