



# THE DATASHEET OF STP80N6F6



## Automotive-grade N-channel 60 V, 4.4 mΩ typ., 80 A STripFET™ VI DeepGATE™ Power MOSFET in a TO-220 package

Datasheet - production data

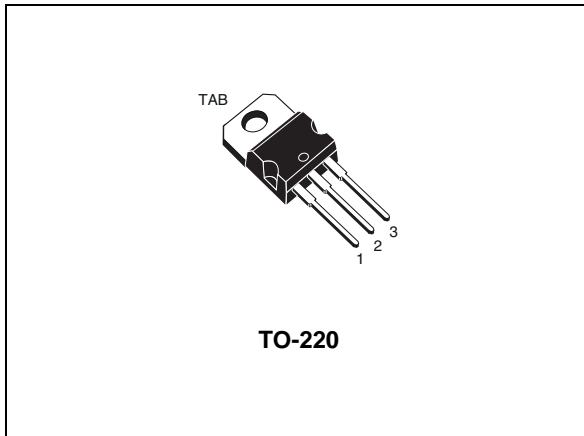

**Figure 1. Internal schematic diagram**

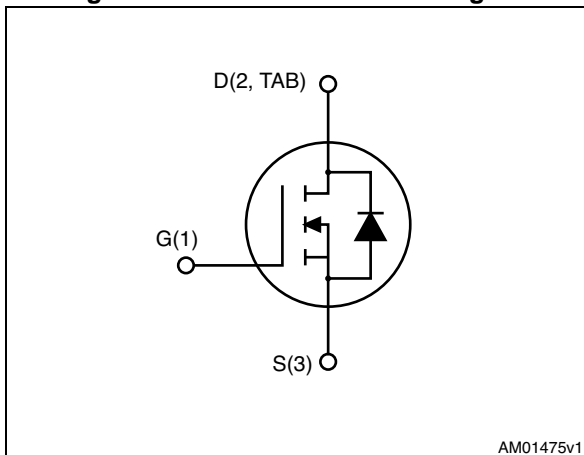

### Features

Order code	V <sub>DS</sub>	R <sub>DS(on)</sub> max.	I <sub>D</sub>
STP80N6F6	60 V	5 mΩ	80 A <sup>(1)</sup>

1. Current limited by package

- Designed for automotive applications and AEC-Q101 qualified
- Low gate charge
- Very low on-resistance
- High avalanche ruggedness

### Applications

- Switching applications

### Description

This device is an N-channel Power MOSFET developed using the 6<sup>th</sup> generation of STripFET™ DeepGATE™ technology, with a new gate structure. The resulting Power MOSFET exhibits the lowest R<sub>DS(on)</sub> in all packages.

**Table 1. Device summary**

Order code	Marking	Packages	Packaging
STP80N6F6	80N6F6	TO-220	Tube

# Contents

<b>1</b>	<b>Electrical ratings</b> .....	<b>3</b>
<b>2</b>	<b>Electrical characteristics</b> .....	<b>4</b>
	2.1 Electrical characteristics (curves) .....	6
<b>3</b>	<b>Package mechanical data</b> .....	<b>8</b>
<b>4</b>	<b>Revision history</b> .....	<b>11</b>

# 1 Electrical ratings

**Table 2. Absolute maximum ratings**

Symbol	Parameter	Value	Unit
$V_{DS}$	Drain-source voltage	60	V
$V_{GS}$	Gate-source voltage	$\pm 20$	V
$I_D^{(1)}$	Drain current (continuous) at $T_C = 25\text{ }^\circ\text{C}$	80	A
$I_D^{(1)}$	Drain current (continuous) at $T_C = 100\text{ }^\circ\text{C}$	80	A
$I_{DM}^{(1)}$	Drain current (pulsed)	320	A
$P_{TOT}$	Total dissipation at $T_C = 25\text{ }^\circ\text{C}$	120	W
	Derating factor	0.8	W/ $^\circ\text{C}$
$T_{stg}$	Storage temperature	- 55 to 175	$^\circ\text{C}$
$T_j$	Operating junction temperature		

1. Current limited by package

**Table 3. Thermal data**

Symbol	Parameter	Value	Unit
$R_{thj-case}$	Thermal resistance junction-case max	1.25	$^\circ\text{C}/\text{W}$
$R_{thj-a}$	Thermal resistance junction-ambient max	62.5	$^\circ\text{C}/\text{W}$

## 2 Electrical characteristics

( $T_{CASE} = 25\text{ °C}$  unless otherwise specified)

**Table 4. On/off states**

Symbol	Parameter	Test conditions	Min.	Typ.	Max.	Unit
$V_{(BR)DSS}$	Drain-source breakdown voltage ( $V_{GS} = 0$ )	$I_D = 250\ \mu A$	60			V
$I_{DSS}$	Zero gate voltage Drain current ( $V_{GS} = 0$ )	$V_{DS} = 60\text{ V}$			1	$\mu A$
		$V_{DS} = 60\text{ V}, T_C = 125\text{ °C}$			100	$\mu A$
$I_{GSS}$	Gate-body leakage current ( $V_{DS} = 0$ )	$V_{GS} = \pm 20\text{ V}$			$\pm 100$	nA
$V_{GS(th)}$	Gate threshold voltage	$V_{DS} = V_{GS}, I_D = 250\ \mu A$	3		4.5	V
$R_{DS(on)}$	Static drain-source on-resistance	$V_{GS} = 10\text{ V}, I_D = 40\text{ A}$		4.4	5	m $\Omega$

**Table 5. Dynamic**

Symbol	Parameter	Test conditions	Min.	Typ.	Max.	Unit
$C_{iss}$	Input capacitance	$V_{DS} = 25\text{ V}, f = 1\text{ MHz}, V_{GS} = 0$	-	8325	-	pF
$C_{oss}$	Output capacitance		-	500	-	pF
$C_{rss}$	Reverse transfer capacitance		-	400	-	pF
$Q_g$	Total gate charge	$V_{DD} = 30\text{ V}, I_D = 80\text{ A}, V_{GS} = 10\text{ V}$	-	147	-	nC
$Q_{gs}$	Gate-source charge		-	44	-	nC
$Q_{gd}$	Gate-drain charge		-	46	-	nC

**Table 6. Switching times**

Symbol	Parameter	Test conditions	Min.	Typ.	Max.	Unit
$t_{d(on)}$	Turn-on delay time	$V_{DD} = 30\text{ V}, I_D = 40\text{ A}, R_G = 4.7\ \Omega, V_{GS} = 10\text{ V}$	-	40	-	ns
$t_r$	Rise time			71		ns
$t_{d(off)}$	Turn-off-delay time		-	132	-	ns
$t_f$	Fall time		-	40	-	ns

Table 7. Source drain diode

Symbol	Parameter	Test conditions	Min.	Typ.	Max	Unit
$I_{SD}$	Source-drain current		-		80	A
$I_{SDM}^{(1)}$	Source-drain current (pulsed)		-		320	A
$V_{SD}^{(2)}$	Forward on voltage	$I_{SD} = 80 \text{ A}, V_{GS} = 0$	-		1.3	V
$t_{rr}$	Reverse recovery time	$I_{SD} = 80 \text{ A}, V_{DD} = 48 \text{ V}$ $di/dt = 100 \text{ A}/\mu\text{s},$ $T_j = 150 \text{ }^\circ\text{C}$	-	46		ns
$Q_{rr}$	Reverse recovery charge		-	65		nC
$I_{RRM}$	Reverse recovery current		-	2.8		A

1. Current limited by package.
2. Pulsed: pulse duration = 300  $\mu\text{s}$ , duty cycle 1.5%

## 2.1 Electrical characteristics (curves)

Figure 2. Safe operating area

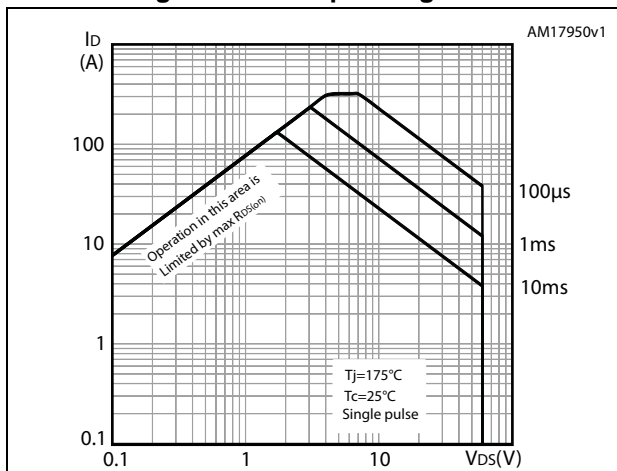

Figure 3. Thermal impedance

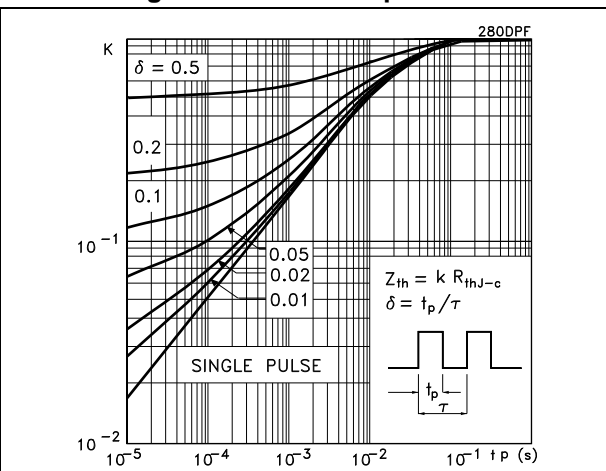

Figure 4. Output characteristics

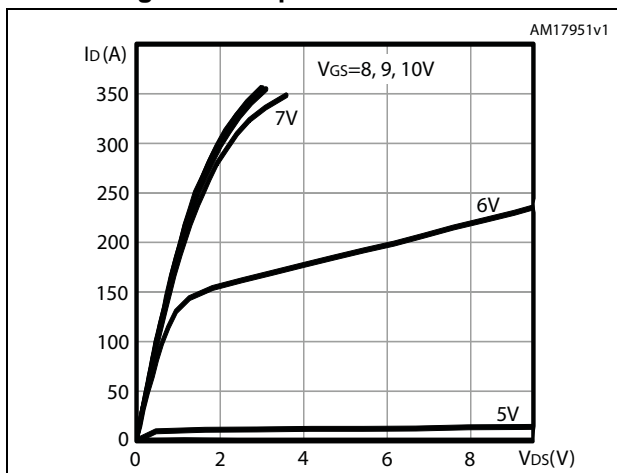

Figure 5. Transfer characteristics

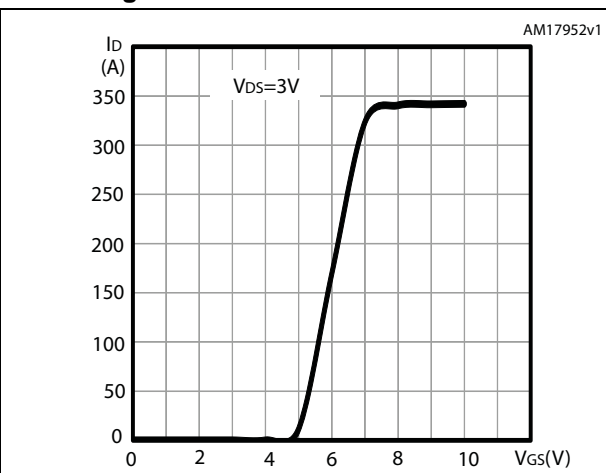

Figure 6. Gate charge vs gate-source voltage

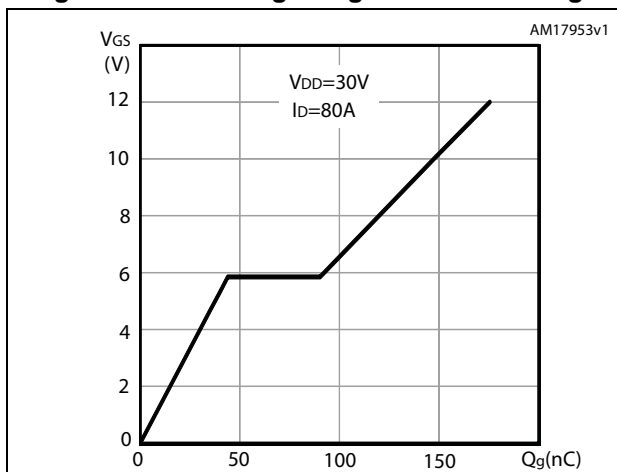

Figure 7. Static drain-source on-resistance

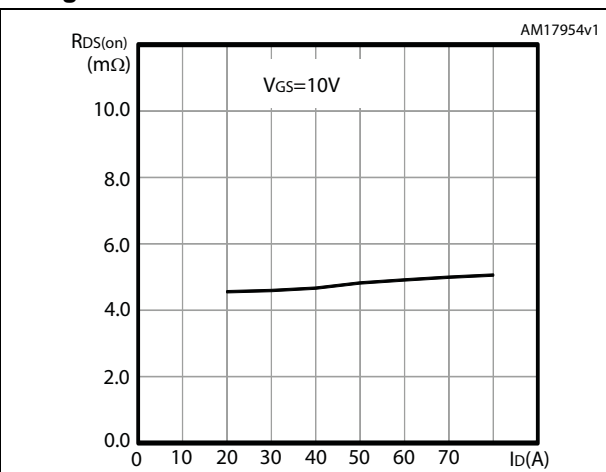

Figure 8. Capacitance variations

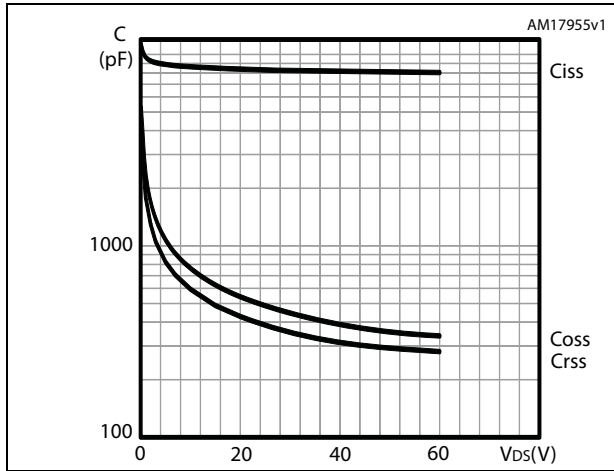

Figure 9. Normalized gate threshold voltage vs temperature

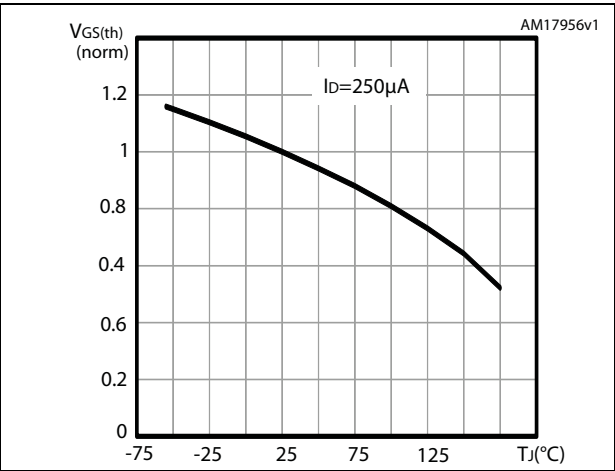

Figure 10. Normalized on-resistance vs temperature

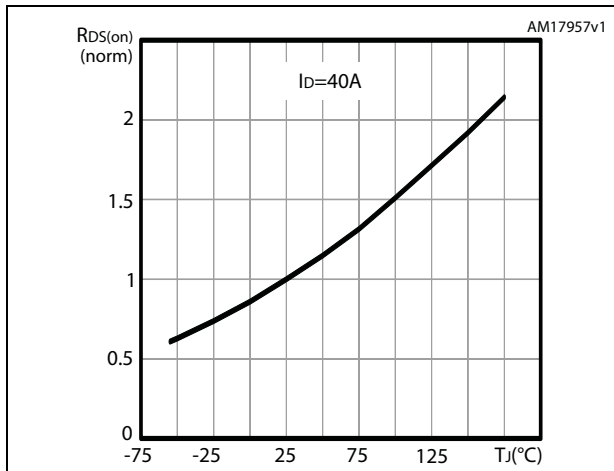

Figure 11. Normalized VDS vs temperature

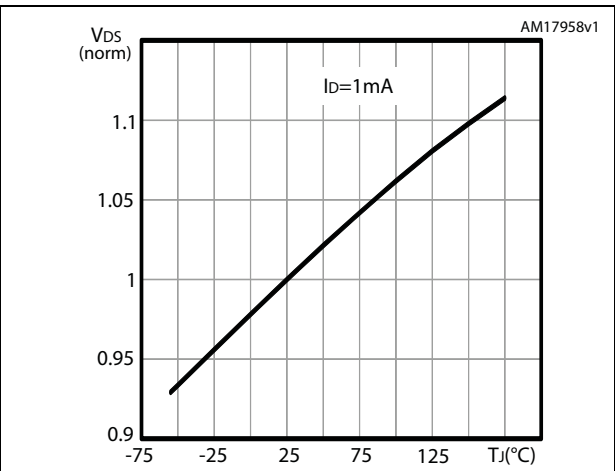
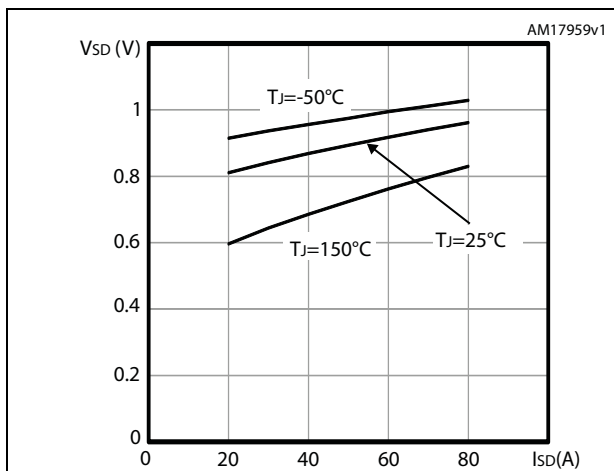

Figure 12. Source-drain diode forward characteristics



### 3 Package mechanical data

In order to meet environmental requirements, ST offers these devices in different grades of ECOPACK<sup>®</sup> packages, depending on their level of environmental compliance. ECOPACK<sup>®</sup> specifications, grade definitions and product status are available at: [www.st.com](http://www.st.com). ECOPACK<sup>®</sup> is an ST trademark.

Figure 13. TO-220 type A drawing

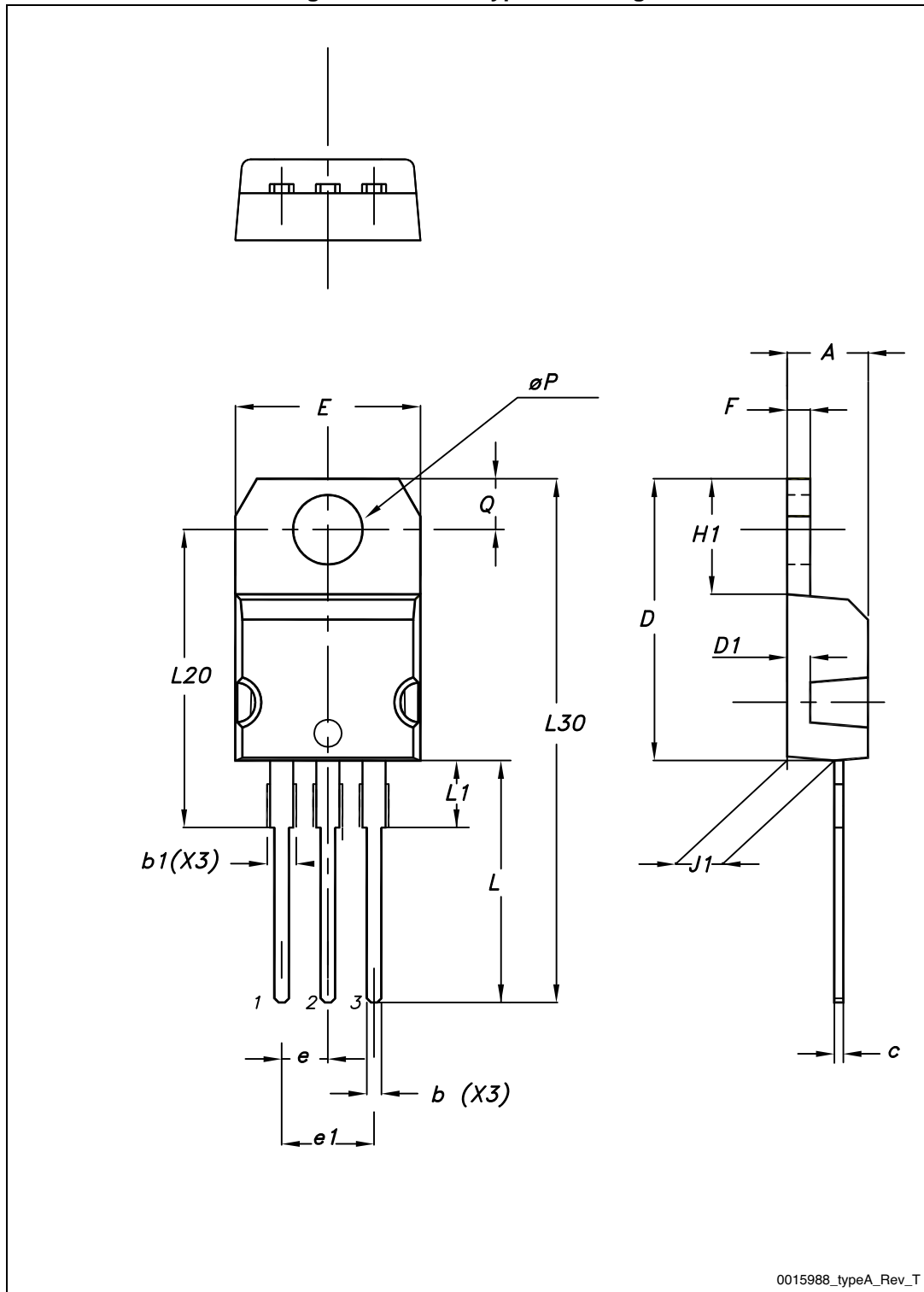

0015988\_typeA\_Rev\_T

Table 8. TO-220 type A mechanical data

Dim.	mm		
	Min.	Typ.	Max.
A	4.40		4.60
b	0.61		0.88
b1	1.14		1.70
c	0.48		0.70
D	15.25		15.75
D1		1.27	
E	10		10.40
e	2.40		2.70
e1	4.95		5.15
F	1.23		1.32
H1	6.20		6.60
J1	2.40		2.72
L	13		14
L1	3.50		3.93
L20		16.40	
L30		28.90	
ØP	3.75		3.85
Q	2.65		2.95

## 4 Revision history

**Table 9. Document revision history**

Date	Revision	Changes
08-Aug-2012	1	Initial release.
21-Jan-2014	2	<ul style="list-style-type: none"> <li>– Document status promoted from preliminary to production data</li> <li>– Modified: title</li> <li>– Modified: <i>Features</i></li> <li>– Added: <i>note 1</i> in cover page</li> <li>– Modified: <math>R_{DS(on)max}</math> and <math>I_D</math> values in cover page</li> <li>– Modified: <math>I_D</math> (at <math>TC = 25\text{ °C}</math> and at <math>TC = 100\text{ °C}</math>) values, <math>I_D</math>, <math>I_{DM}</math> values and added <i>note 1</i> in <i>Table 2</i></li> <li>– Modified: <math>R_{thj-case}</math> value in <i>Table 3</i></li> <li>– Modified: <math>R_{DS(on)}</math> values in <i>Table 4</i></li> <li>– Modified: <math>I_D</math> and the entire typical values in <i>Table 5, 6 and 7</i></li> <li>– Added: <i>Section 2.1: Electrical characteristics (curves)</i></li> <li>– Updated: <i>Section 3: Package mechanical data</i></li> <li>– Minor text changes</li> </ul>

**Please Read Carefully:**

Information in this document is provided solely in connection with ST products. STMicroelectronics NV and its subsidiaries ("ST") reserve the right to make changes, corrections, modifications or improvements, to this document, and the products and services described herein at any time, without notice.

All ST products are sold pursuant to ST's terms and conditions of sale.

Purchasers are solely responsible for the choice, selection and use of the ST products and services described herein, and ST assumes no liability whatsoever relating to the choice, selection or use of the ST products and services described herein.

No license, express or implied, by estoppel or otherwise, to any intellectual property rights is granted under this document. If any part of this document refers to any third party products or services it shall not be deemed a license grant by ST for the use of such third party products or services, or any intellectual property contained therein or considered as a warranty covering the use in any manner whatsoever of such third party products or services or any intellectual property contained therein.

**UNLESS OTHERWISE SET FORTH IN ST'S TERMS AND CONDITIONS OF SALE ST DISCLAIMS ANY EXPRESS OR IMPLIED WARRANTY WITH RESPECT TO THE USE AND/OR SALE OF ST PRODUCTS INCLUDING WITHOUT LIMITATION IMPLIED WARRANTIES OF MERCHANTABILITY, FITNESS FOR A PARTICULAR PURPOSE (AND THEIR EQUIVALENTS UNDER THE LAWS OF ANY JURISDICTION), OR INFRINGEMENT OF ANY PATENT, COPYRIGHT OR OTHER INTELLECTUAL PROPERTY RIGHT.**

**ST PRODUCTS ARE NOT DESIGNED OR AUTHORIZED FOR USE IN: (A) SAFETY CRITICAL APPLICATIONS SUCH AS LIFE SUPPORTING, ACTIVE IMPLANTED DEVICES OR SYSTEMS WITH PRODUCT FUNCTIONAL SAFETY REQUIREMENTS; (B) AERONAUTIC APPLICATIONS; (C) AUTOMOTIVE APPLICATIONS OR ENVIRONMENTS, AND/OR (D) AEROSPACE APPLICATIONS OR ENVIRONMENTS. WHERE ST PRODUCTS ARE NOT DESIGNED FOR SUCH USE, THE PURCHASER SHALL USE PRODUCTS AT PURCHASER'S SOLE RISK, EVEN IF ST HAS BEEN INFORMED IN WRITING OF SUCH USAGE, UNLESS A PRODUCT IS EXPRESSLY DESIGNATED BY ST AS BEING INTENDED FOR "AUTOMOTIVE, AUTOMOTIVE SAFETY OR MEDICAL" INDUSTRY DOMAINS ACCORDING TO ST PRODUCT DESIGN SPECIFICATIONS. PRODUCTS FORMALLY ESCC, QML OR JAN QUALIFIED ARE DEEMED SUITABLE FOR USE IN AEROSPACE BY THE CORRESPONDING GOVERNMENTAL AGENCY.**

Resale of ST products with provisions different from the statements and/or technical features set forth in this document shall immediately void any warranty granted by ST for the ST product or service described herein and shall not create or extend in any manner whatsoever, any liability of ST.

ST and the ST logo are trademarks or registered trademarks of ST in various countries.

Information in this document supersedes and replaces all information previously supplied.

The ST logo is a registered trademark of STMicroelectronics. All other names are the property of their respective owners.

© 2014 STMicroelectronics - All rights reserved



STMicroelectronics group of companies

Australia - Belgium - Brazil - Canada - China - Czech Republic - Finland - France - Germany - Hong Kong - India - Israel - Italy - Japan - Malaysia - Malta - Morocco - Philippines - Singapore - Spain - Sweden - Switzerland - United Kingdom - United States of America

[www.st.com](http://www.st.com)

## Looking for pricing, stock, or lifecycle information?

Click below to explore more details on WIN SOURCE:

-  [View STP80N6F6 on WIN SOURCE](#)
-  [STMicroelectronics Information](#)

## Optimize Your Supply Chain with WIN SOURCE Solutions

-  Global Sourcing Solution
-  Obsolete Management
-  Cost Control Management
-  Shortage Management
-  Alternative Solution
-  Excess Inventory Management