

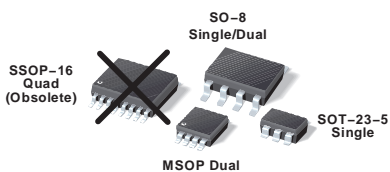

**THE DATASHEET OF
OPA237NA/3KG4**





SINGLE-SUPPLY OPERATIONAL AMPLIFIERS

MicroAmplifier™ Series

FEATURES

- MICRO-SIZE, MINIATURE PACKAGES:
 - Single: SOT23-5, SO-8
 - Dual: MSOP-8, SO-8
 - Quad: SSOP-16 (Obsolete)
- LOW OFFSET VOLTAGE: 750µV max
- WIDE SUPPLY RANGE:
 - Single Supply: +2.7V to +36V
 - Dual Supply: ±1.35V to ±18V
- LOW QUIESCENT CURRENT: 350µV max
- WIDE BANDWIDTH: 1.5MHz

APPLICATIONS

- BATTERY-POWERED INSTRUMENTS
- PORTABLE DEVICES
- PCMCIA CARDS
- MEDICAL INSTRUMENTS
- TEST EQUIPMENT

DESCRIPTION

The OPA237 op amp family is one of Texas Instruments' MicroAmplifier™ series of miniature products. In addition to small size, these devices feature low offset voltage, low quiescent current, low bias current, and a wide supply range. Single, dual, and quad versions have identical specifications for maximum design flexibility. They are ideal for single-supply, battery-operated, and space-limited applications, such as PCMCIA cards and other portable instruments.

OPA237 series op amps can operate from either single or dual supplies. When operated from a single supply, the input common-mode range extends below ground and the output can swing to within 10mV of ground. Dual and quad designs feature completely independent circuitry for lowest crosstalk and freedom from interaction.

Single, dual, and quad are offered in space-saving surface-mount packages. The single version is available in the ultra-miniature 5-lead SOT23-5 and SO-8 surface-mount. The dual version comes in a miniature MSOP-8 and SO-8 surface-mount. The quad version is obsolete. MSOP-8 has the same lead count as a SO-8 but half the size. The SOT23-5 is even smaller at one-fourth the size of an SO-8. All are specified for –40°C to +85°C operation. A macromodel is available for design analysis.

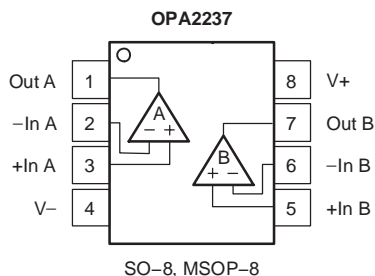
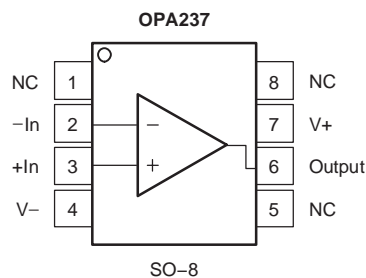
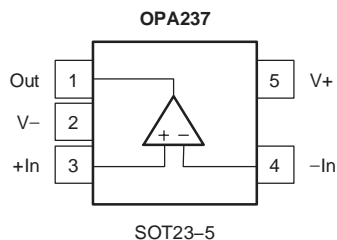

Please be aware that an important notice concerning availability, standard warranty, and use in critical applications of Texas Instruments semiconductor products and disclaimers thereto appears at the end of this data sheet.

MicroAmplifier is a trademark of Texas Instruments. All other trademarks are the property of their respective owners.

ABSOLUTE MAXIMUM RATINGS(1)

Supply Voltage, V+ to V–	36V
Input Voltage	(V–) –0.7V to (V+) +0.7V
Output Short-Circuit(2)	Continuous
Operating Temperature Range	–55°C to +125°C
Storage Temperature Range	–55°C to +125°C
Junction Temperature Range	+150°C

(1) Stresses above these ratings may cause permanent damage.

Exposure to absolute maximum conditions for extended periods may degrade device reliability. These are stress ratings only, and functional operation of the device at these or any other conditions beyond those specified is not implied.

(2) Short circuit to ground, one amplifier per package.



This integrated circuit can be damaged by ESD. Texas Instruments recommends that all integrated circuits be handled with appropriate precautions. Failure to observe proper handling and installation procedures can cause damage.

ESD damage can range from subtle performance degradation to complete device failure. Precision integrated circuits may be more susceptible to damage because very small parametric changes could cause the device not to meet its published specifications.

PACKAGE/ORDERING INFORMATION(1)

PRODUCT	PACKAGE-LEAD	PACKAGE DRAWING	PACKAGE MARKING
Single			
OPA237NA	SOT23-5	DBV	A37A
OPA237UA	SO-8	D	OPA237UA
Dual			
OPA2237EA	MSOP-8	DGK	B37A
OPA2237UA	SO-8	D	OPA2237UA
Quad(2)			
OPA4237UA	SSOP-16	DBQ	OPA4237UA

(1) For the most current package and ordering information, see the Package Option Addendum at the end of this document, or see the TI website at www.ti.com.

(2) Quad version is obsolete.

ELECTRICAL CHARACTERISTICS: $V_S = +5V$

Boldface limits apply over the specified temperature range, $T_A = -40^\circ\text{C}$ to $+85^\circ\text{C}$.

At $T_A = +25^\circ\text{C}$, $V_S = +5V$, $R_L = 10\text{k}\Omega$, connected to $V_S/2$, unless otherwise noted.

PARAMETER	CONDITIONS	OPA237UA, NA OPA2237UA, EA OPA4237UA			UNITS
		MIN	TYP	MAX	
OFFSET VOLTAGE					
Input Offset Voltage	$V_{CM} = 2.5V$		± 250	± 750	μV
vs Temperature⁽¹⁾	Specified Temperature Range		± 2	± 5	$\mu V/^\circ\text{C}$
vs Power Supply (PSRR)	$V_S = +2.7V$ to $+36V$		10	30	$\mu V/V$
Channel Separation (dual and quad)			0.5		$\mu V/V$
INPUT BIAS CURRENT					
Input Bias Current ⁽²⁾	$V_{CM} = 2.5V$		-10	-40	nA
Input Offset Current	$V_{CM} = 2.5V$		± 0.5	± 10	nA
NOISE					
Input Voltage Noise, $f = 0.1$ to 10Hz			1		μV_{pp}
Input Voltage Noise Density, $f = 1\text{kHz}$			28		$nV/\sqrt{\text{Hz}}$
Current Noise Density, $f = 1\text{kHz}$			60		$fA/\sqrt{\text{Hz}}$
INPUT VOLTAGE RANGE					
Common-Mode Voltage Range		-0.2		(V+) -1.5	V
Common-Mode Rejection Ratio	$V_{CM} = -0.2V$ to $3.5V$	78	86		dB
INPUT IMPEDANCE					
Differential			$5 \cdot 10^6 \parallel 4$		$\Omega \parallel pF$
Common-Mode			$5 \cdot 10^9 \parallel 2$		$\Omega \parallel pF$
OPEN-LOOP GAIN					
Open-Loop Voltage Gain	$V_O = 0.5V$ to $4V$	80	88		dB
FREQUENCY RESPONSE					
Gain-Bandwidth Product			1.4		MHz
Slew Rate	$G = 1$		0.5		$V/\mu s$
Settling Time, 0.1%	$G = -1$, 3V Step, $C_L = 100pF$		11		μs
0.01%	$G = -1$, 3V Step, $C_L = 100pF$		16		μs
OUTPUT					
Voltage Output, Positive	$R_L = 100k\Omega$ to Ground	(V+) -1	(V+) -0.75		V
Negative	$R_L = 100k\Omega$ to Ground	0.01	0.001		V
Positive	$R_L = 100k\Omega$ to $2.5V$	(V+) -1	(V+) -0.75		V
Negative	$R_L = 100k\Omega$ to $2.5V$	0.12	0.04		V
Positive	$R_L = 10k\Omega$ to $2.5V$	(V+) -1	(V+) -0.75		V
Negative	$R_L = 10k\Omega$ to $2.5V$	0.5	0.35		V
Short-Circuit Current			-10/+4		mA
Capacitive Load Drive (stable operation)		See Typical Characteristic Curves			
POWER SUPPLY					
Specified Operating Voltage			+5		V
Operating Range		+2.7		+36	V
Quiescent Current (per amplifier)			170	350	μA
TEMPERATURE RANGE					
Specified Range		-40		+85	$^\circ\text{C}$
Operating Range		-55		+125	$^\circ\text{C}$
Storage Range		-55		+125	$^\circ\text{C}$
Thermal Resistance, θ_{JA}					
SOT23-5			200		$^\circ\text{C/W}$
MSOP-8			150		$^\circ\text{C/W}$
SSOP-16 (Obsolete)			150		$^\circ\text{C/W}$
SO-8			150		$^\circ\text{C/W}$

(1) Specified by wafer-level test to 95% confidence.

(2) Positive conventional current flows into the input terminals.

ELECTRICAL CHARACTERISTICS: $V_S = +2.7V$

Boldface limits apply over the specified temperature range, $T_A = -40^\circ C$ to $+85^\circ C$.

At $T_A = +25^\circ C$, $V_S = +2.7V$, $R_L = 10k\Omega$, connected to $V_S/2$, unless otherwise noted.

PARAMETER	CONDITIONS	OPA237UA, NA OPA2237UA, EA OPA4237UA			UNITS
		MIN	TYP	MAX	
OFFSET VOLTAGE Input Offset Voltage vs Temperature⁽¹⁾ vs Power Supply (PSRR) Channel Separation (dual and quad)	$V_{CM} = 1V$ Specified Temperature Range $V_S = +2.7V$ to $+36V$		± 250 ± 2 10 0.5	± 750 ± 5 30	μV $\mu V/^\circ C$ $\mu V/V$ $\mu V/V$
INPUT BIAS CURRENT Input Bias Current ⁽²⁾ Input Offset Current	$V_{CM} = 1V$ $V_{CM} = 1V$		-10 ± 0.5	-40 ± 10	nA nA
NOISE Input Voltage Noise, $f = 0.1$ to $10Hz$ Input Voltage Noise Density, $f = 1kHz$ Current Noise Density, $f = 1kHz$			1 28 60		μV_{PP} nV/\sqrt{Hz} fA/\sqrt{Hz}
INPUT VOLTAGE RANGE Common-Mode Voltage Range Common-Mode Rejection Ratio	$V_{CM} = -0.2V$ to $1.2V$	-0.2 75	85	(V+) -1.5	V dB
INPUT IMPEDANCE Differential Common-Mode			$5 \cdot 10^6 \parallel 4$ $5 \cdot 10^9 \parallel 2$		$\Omega \parallel pF$ $\Omega \parallel pF$
OPEN-LOOP GAIN Open-Loop Voltage Gain	$V_O = 0.5V$ to $1.7V$	80	88		dB
FREQUENCY RESPONSE Gain-Bandwidth Product Slew Rate Settling Time, 0.1% 0.01%	$G = 1$ $G = -1$, 1V Step, $C_L = 100pF$ $G = -1$, 1V Step, $C_L = 100pF$		1.2 0.5 5 8		MHz V/ μs μs μs
OUTPUT Voltage Output, Positive Negative Positive Negative Positive Negative Short-Circuit Current Capacitive Load Drive (stable operation)	$R_L = 100k\Omega$ to Ground $R_L = 100k\Omega$ to Ground $R_L = 100k\Omega$ to $1.35V$ $R_L = 100k\Omega$ to $1.35V$ $R_L = 10k\Omega$ to $1.35V$ $R_L = 10k\Omega$ to $1.35V$	(V+) -1 0.01 (V+) -1 0.06 (V+) -1 0.3	(V+) -0.75 0.001 (V+) -0.75 0.02 (V+) -0.75 0.2 -5/+3.5		V V V V V V mA
POWER SUPPLY Specified Operating Voltage Operating Range Quiescent Current (per amplifier)		+2.7	+2.7 160	+36 350	V V μA
TEMPERATURE RANGE Specified Range Operating Range Storage Range Thermal Resistance, θ_{JA} SOT23-5 MSOP-8 SSOP-16 (Obsolete) SO-8		-40 -55 -55		+85 +125 +125	$^\circ C$ $^\circ C$ $^\circ C$ $^\circ C/W$ $^\circ C/W$ $^\circ C/W$ $^\circ C/W$

(1) Specified by wafer-level test to 95% confidence.

(2) Positive conventional current flows into the input terminals.

ELECTRICAL CHARACTERISTICS: $V_S = \pm 15V$

Boldface limits apply over the specified temperature range, $T_A = -40^\circ C$ to $+85^\circ C$.

At $T_A = +25^\circ C$, $V_S = \pm 15V$, $R_L = 10k\Omega$, connected to $V_S/2$, unless otherwise noted.

PARAMETER	CONDITIONS	OPA237UA, NA OPA2237UA, EA OPA4237UA			UNITS
		MIN	TYP	MAX	
OFFSET VOLTAGE					
Input Offset Voltage	$V_{CM} = 0V$		± 350	± 950	μV
vs Temperature⁽¹⁾	Specified Temperature Range		± 2.5	± 7	$\mu V/^\circ C$
vs Power Supply (PSRR)	$V_S = \pm 1.35V$ to $\pm 18V$		10	30	$\mu V/V$
Channel Separation (dual and quad)			0.5		$\mu V/V$
INPUT BIAS CURRENT					
Input Bias Current ⁽²⁾	$V_{CM} = 0V$		-8.5	-40	nA
Input Offset Current	$V_{CM} = 0V$		± 0.5	± 10	nA
NOISE					
Input Voltage Noise, $f = 0.1$ to $10Hz$			1		μV_{pp}
Input Voltage Noise Density, $f = 1kHz$			28		nV/\sqrt{Hz}
Current Noise Density, $f = 1kHz$			60		fA/\sqrt{Hz}
INPUT VOLTAGE RANGE					
Common-Mode Voltage Range		(V-) -0.2		(V+) -1.5	V
Common-Mode Rejection Ratio	$V_{CM} = -15V$ to $13.5V$	80	90		dB
INPUT IMPEDANCE					
Differential			$5 \cdot 10^6 \parallel 4$		$\Omega \parallel pF$
Common-Mode			$5 \cdot 10^9 \parallel 2$		$\Omega \parallel pF$
OPEN-LOOP GAIN					
Open-Loop Voltage Gain	$V_O = -14V$ to $13.8V$	80	88		dB
FREQUENCY RESPONSE					
Gain-Bandwidth Product			1.5		MHz
Slew Rate	$G = 1$		0.5		V/ μs
Settling Time, 0.1%	$G = -1$, 10V Step, $C_L = 100pF$		18		μs
0.01%	$G = -1$, 10V Step, $C_L = 100pF$		21		μs
OUTPUT					
Voltage Output, Positive	$R_L = 100k\Omega$	(V+) -1.2	(V+) -0.9		V
Negative	$R_L = 100k\Omega$	(V-) +0.5	(V-) +0.3		V
Positive	$R_L = 10k\Omega$	(V+) -1.2	(V+) -0.9		V
Negative	$R_L = 10k\Omega$	(V-) +1	(V-) +0.85		V
Short-Circuit Current			-8/+4.5		mA
Capacitive Load Drive (stable operation)		See Typical Characteristic Curves			
POWER SUPPLY					
Specified Operating Range			± 15		V
Operating Range		± 1.35		± 18	V
Quiescent Current (per amplifier)			± 200	± 475	μA
TEMPERATURE RANGE					
Specified Range		-40		+85	$^\circ C$
Operating Range		-55		+125	$^\circ C$
Storage Range		-55		+125	$^\circ C$
Thermal Resistance, θ_{JA}					$^\circ C/W$
SOT23-5			200		$^\circ C/W$
MSOP-8			150		$^\circ C/W$
SSOP-16 (Obsolete)			150		$^\circ C/W$
SO-8			150		$^\circ C/W$

(1) Specified by wafer-level test to 95% confidence.

(2) Positive conventional current flows into the input terminals.

TYPICAL CHARACTERISTICS

At $T_A = +25^\circ\text{C}$ and $R_L = 10\text{k}\Omega$, unless otherwise noted.

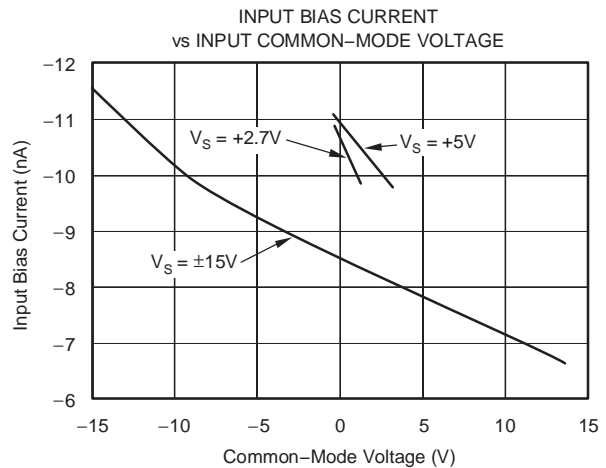
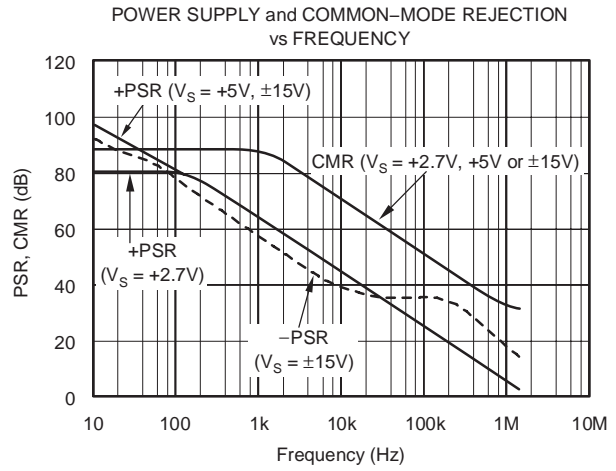
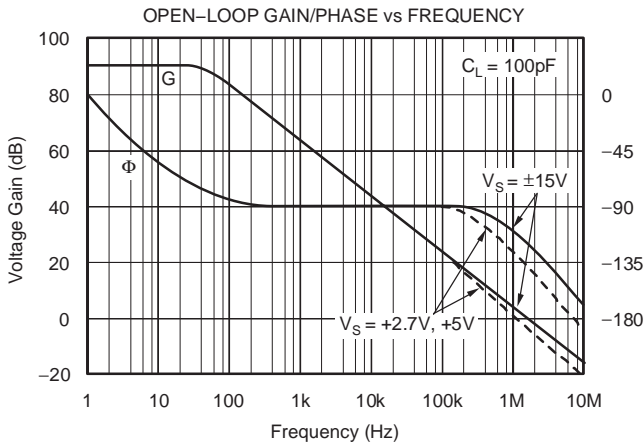

TYPICAL CHARACTERISTICS (Continued)

At $T_A = +25^\circ\text{C}$ and $R_L = 10\text{k}\Omega$, unless otherwise noted.

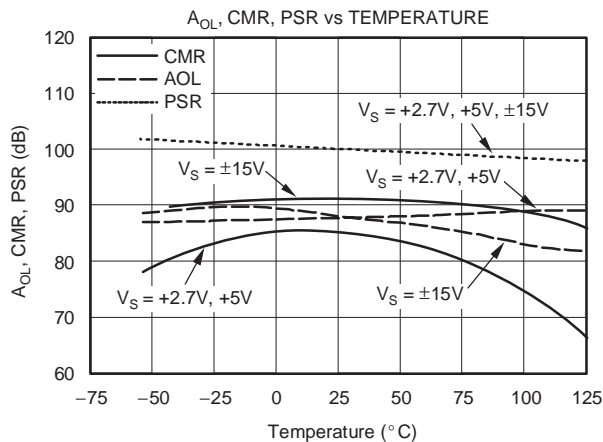
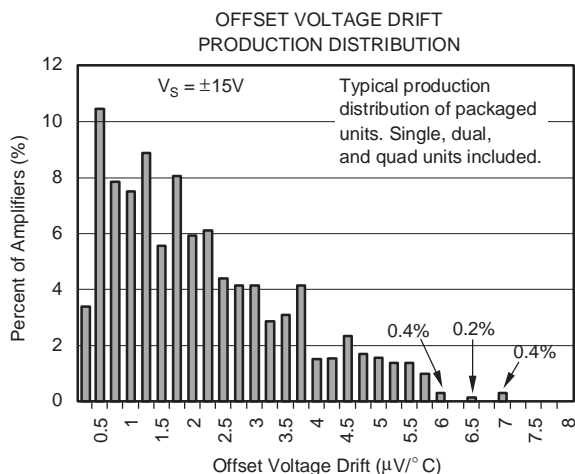
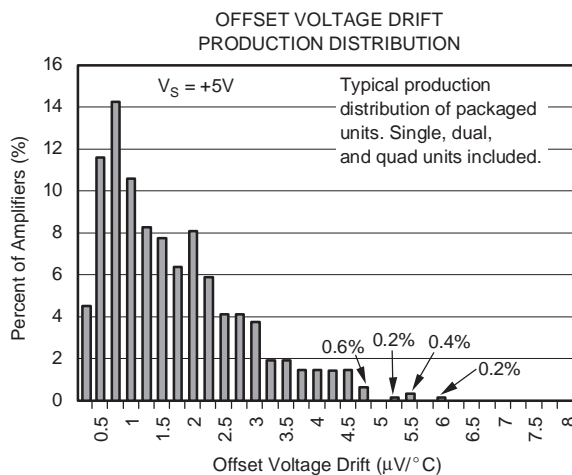
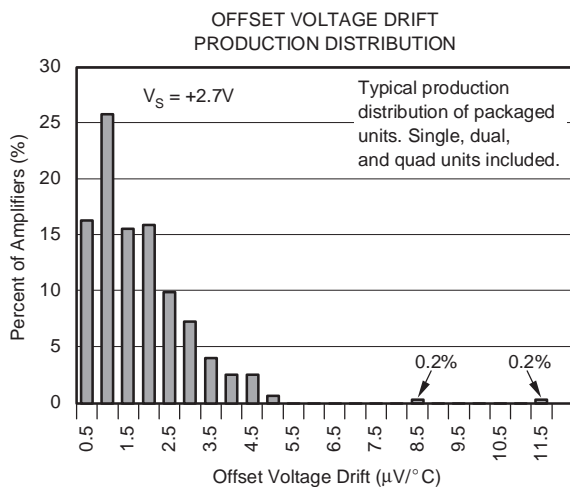
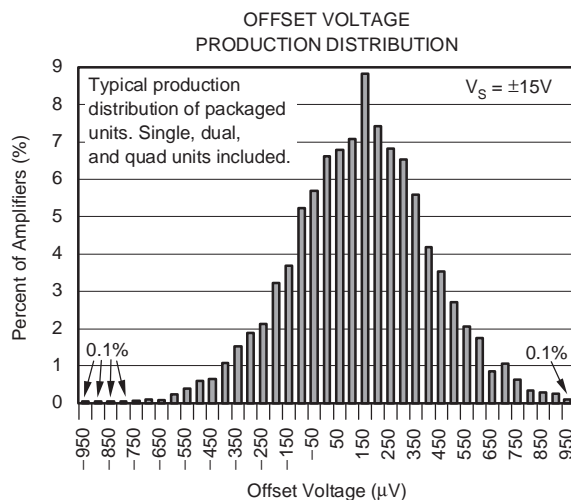
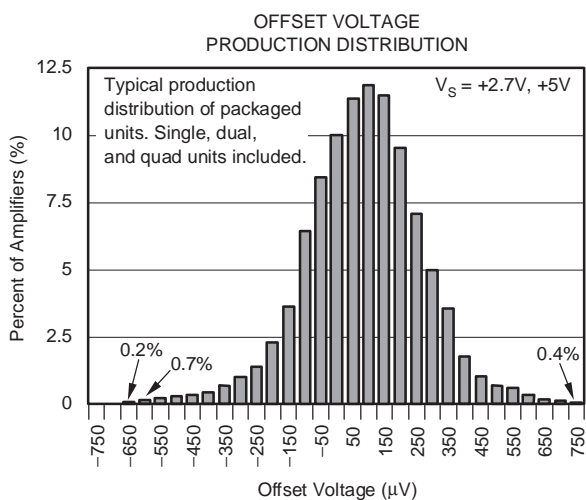

TYPICAL CHARACTERISTICS (Continued)

At $T_A = +25^\circ\text{C}$ and $R_L = 10\text{k}\Omega$, unless otherwise noted.

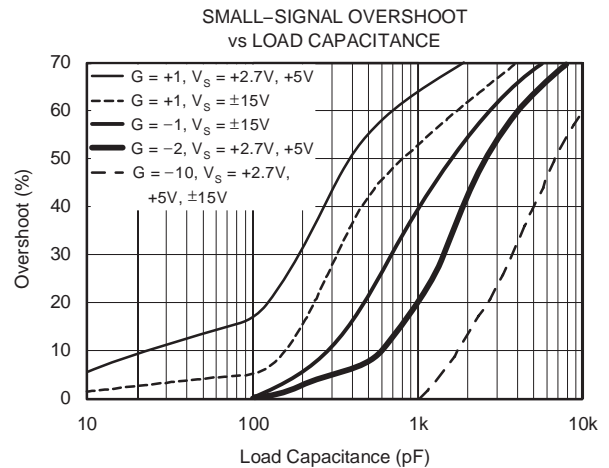
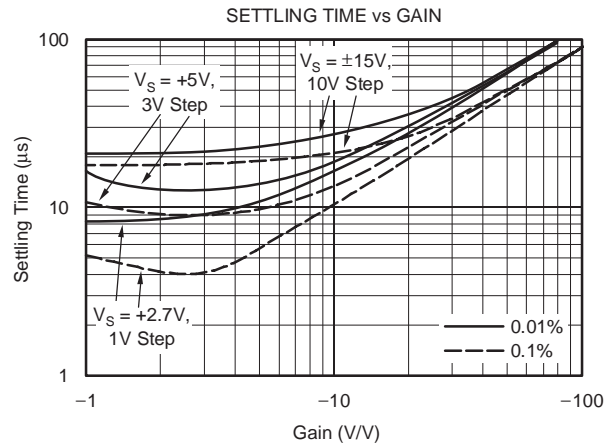
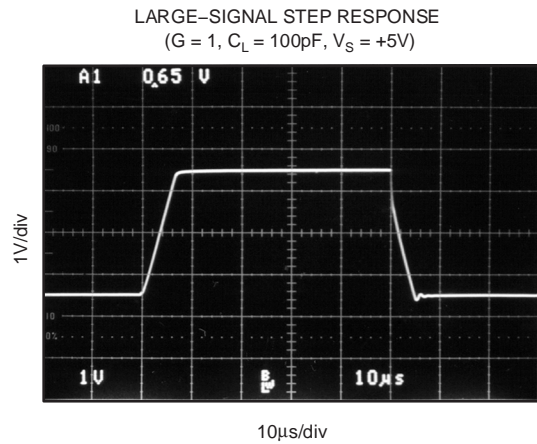
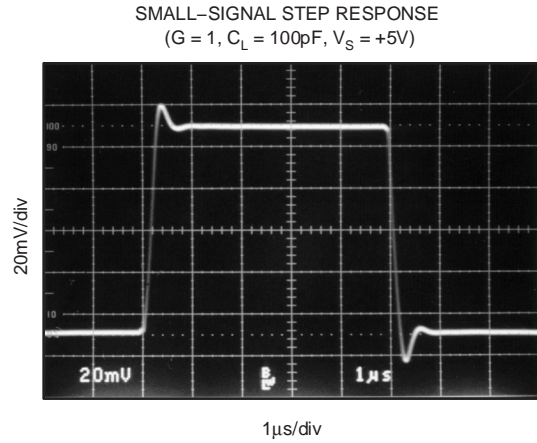

TYPICAL CHARACTERISTICS (Continued)

At $T_A = +25^\circ\text{C}$ and $R_L = 10\text{k}\Omega$, unless otherwise noted.

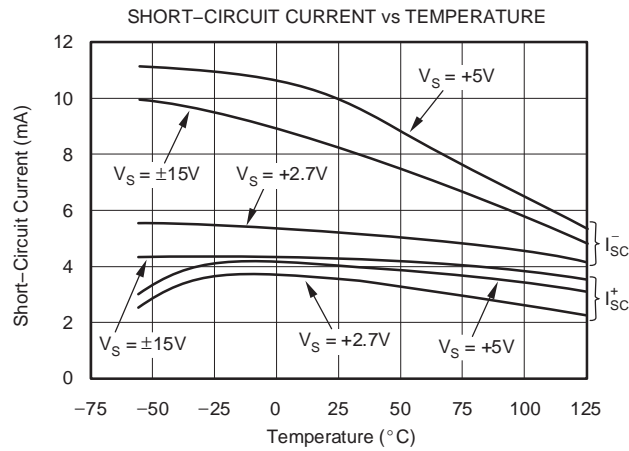
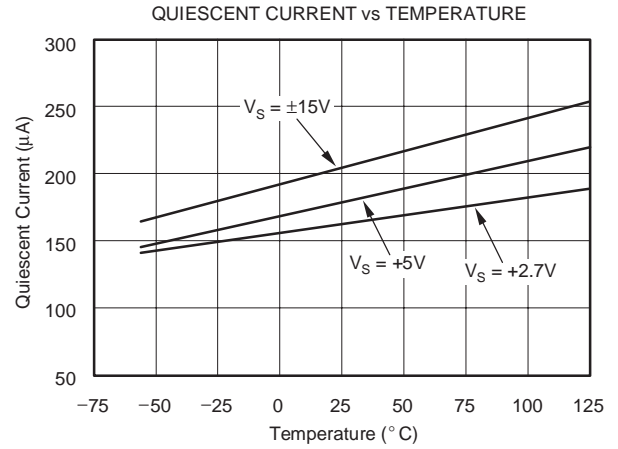
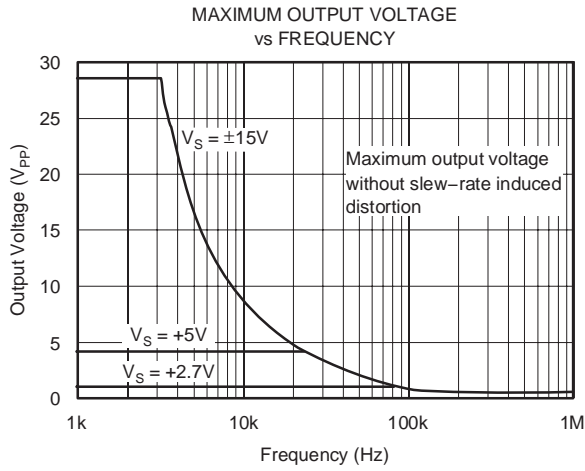

APPLICATION INFORMATION

OPA237 series op amps are unity-gain stable and suitable for a wide range of general-purpose applications. Power supply pins should be bypassed with 10nF ceramic capacitors.

OPERATING VOLTAGE

OPA237 series op amps operate from single (+2.7V to +36V) or dual ($\pm 1.35V$ to $\pm 18V$) supplies with excellent performance. Most behavior remains unchanged throughout the full operating voltage range. Parameters which vary significantly with operating voltage are shown in typical performance curves. Specifications are production tested with +2.7V, +5V, and $\pm 15V$ supplies.

OUTPUT CURRENT AND STABILITY

OPA237 series op amps can drive large capacitive loads. However, under certain limited output conditions any op amp may become unstable. Figure 1 shows the region where the OPA237 has a potential for instability. These load conditions are rarely encountered, especially for single supply applications. For example, take the case when a +5V supply with a 10k Ω load to $V_S/2$ is used.

OPA237 series op amps remain stable with capacitive loads up to 4,000pF, if sinking current and up to 10,000pF, if sourcing current. Furthermore, in single-supply applications where the load is connected to ground, the op amp is only sourcing current, and as shown Figure 1, can drive 10,000pF with output currents up to 1.5mA.

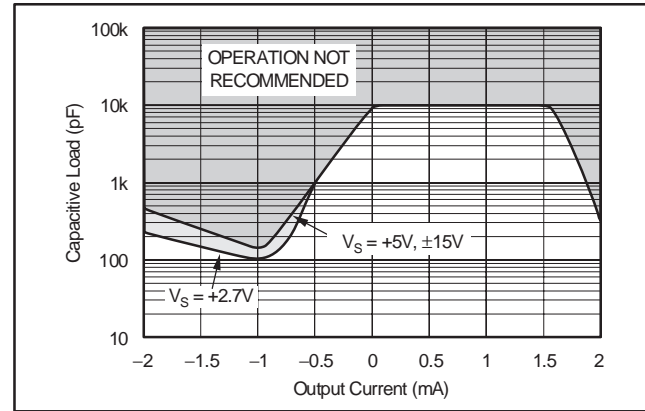

Figure 1. Stability-Capacitive Load vs Output Current

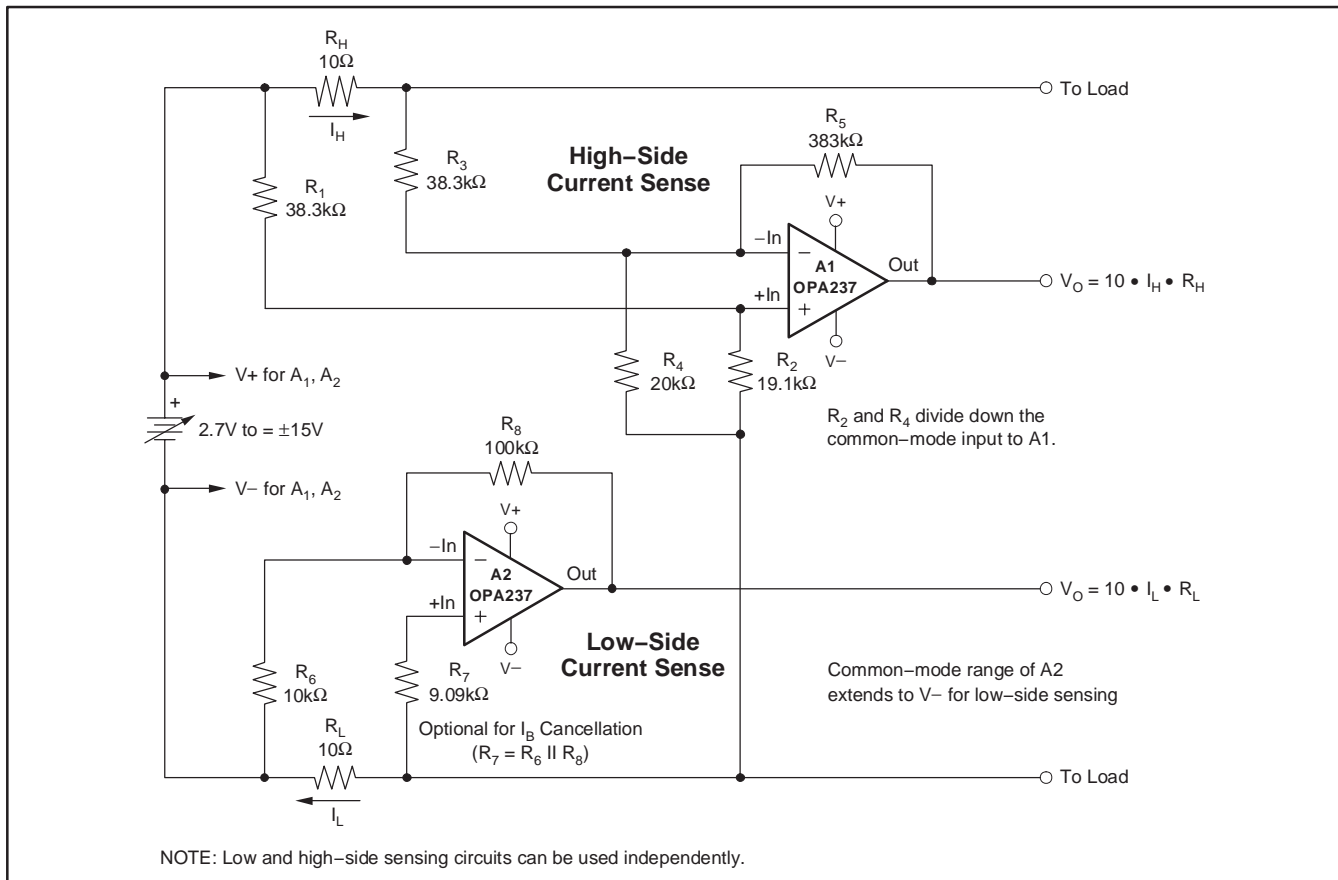

Figure 2. Low and High-Side Battery Current Sensing

PACKAGING INFORMATION

Orderable Device	Status (1)	Package Type	Package Drawing	Pins	Package Qty	Eco Plan (2)	Lead/Ball Finish (6)	MSL Peak Temp (3)	Op Temp (°C)	Device Marking (4/5)	Samples
OPA2237EA/250	ACTIVE	VSSOP	DGK	8	250	Green (RoHS & no Sb/Br)	CU NIPDAUAG	Level-2-260C-1 YEAR		B37A	Samples
OPA2237EA/2K5	ACTIVE	VSSOP	DGK	8	2500	Green (RoHS & no Sb/Br)	CU NIPDAUAG	Level-2-260C-1 YEAR	-40 to 85	B37A	Samples
OPA2237UA	ACTIVE	SOIC	D	8	75	Green (RoHS & no Sb/Br)	CU NIPDAU	Level-3-260C-168 HR		OPA 2237UA	Samples
OPA2237UA/2K5	ACTIVE	SOIC	D	8	2500	Green (RoHS & no Sb/Br)	CU NIPDAU	Level-3-260C-168 HR		OPA 2237UA	Samples
OPA2237UAE4	ACTIVE	SOIC	D	8	75	Green (RoHS & no Sb/Br)	CU NIPDAU	Level-3-260C-168 HR		OPA 2237UA	Samples
OPA237NA/250	ACTIVE	SOT-23	DBV	5	250	Green (RoHS & no Sb/Br)	CU NIPDAU	Level-2-260C-1 YEAR	-40 to 70	A37A	Samples
OPA237NA/250E4	ACTIVE	SOT-23	DBV	5	250	Green (RoHS & no Sb/Br)	CU NIPDAU	Level-2-260C-1 YEAR	-40 to 70	A37A	Samples
OPA237NA/3K	ACTIVE	SOT-23	DBV	5	3000	Green (RoHS & no Sb/Br)	CU NIPDAU	Level-2-260C-1 YEAR	-40 to 70	A37A	Samples
OPA237NA/3KE4	ACTIVE	SOT-23	DBV	5	3000	Green (RoHS & no Sb/Br)	CU NIPDAU	Level-2-260C-1 YEAR	-40 to 70	A37A	Samples
OPA237UA	ACTIVE	SOIC	D	8	75	Green (RoHS & no Sb/Br)	CU NIPDAU	Level-3-260C-168 HR	-40 to 70	OPA 237UA	Samples
OPA237UA/2K5	ACTIVE	SOIC	D	8	2500	Green (RoHS & no Sb/Br)	CU NIPDAU	Level-3-260C-168 HR	-40 to 70	OPA 237UA	Samples
OPA237UA/2K5G4	ACTIVE	SOIC	D	8	2500	Green (RoHS & no Sb/Br)	CU NIPDAU	Level-3-260C-168 HR	-40 to 70	OPA 237UA	Samples

(1) The marketing status values are defined as follows:

ACTIVE: Product device recommended for new designs.

LIFEBUY: TI has announced that the device will be discontinued, and a lifetime-buy period is in effect.

NRND: Not recommended for new designs. Device is in production to support existing customers, but TI does not recommend using this part in a new design.

PREVIEW: Device has been announced but is not in production. Samples may or may not be available.

OBSELETE: TI has discontinued the production of the device.

(2) **RoHS:** TI defines "RoHS" to mean semiconductor products that are compliant with the current EU RoHS requirements for all 10 RoHS substances, including the requirement that RoHS substance do not exceed 0.1% by weight in homogeneous materials. Where designed to be soldered at high temperatures, "RoHS" products are suitable for use in specified lead-free processes. TI may reference these types of products as "Pb-Free".

RoHS Exempt: TI defines "RoHS Exempt" to mean products that contain lead but are compliant with EU RoHS pursuant to a specific EU RoHS exemption.

Green: TI defines "Green" to mean the content of Chlorine (Cl) and Bromine (Br) based flame retardants meet JS709B low halogen requirements of ≤ 1000 ppm threshold. Antimony trioxide based flame retardants must also meet the ≤ 1000 ppm threshold requirement.

(3) MSL, Peak Temp. - The Moisture Sensitivity Level rating according to the JEDEC industry standard classifications, and peak solder temperature.

(4) There may be additional marking, which relates to the logo, the lot trace code information, or the environmental category on the device.

(5) Multiple Device Markings will be inside parentheses. Only one Device Marking contained in parentheses and separated by a "~" will appear on a device. If a line is indented then it is a continuation of the previous line and the two combined represent the entire Device Marking for that device.

(6) Lead/Ball Finish - Orderable Devices may have multiple material finish options. Finish options are separated by a vertical ruled line. Lead/Ball Finish values may wrap to two lines if the finish value exceeds the maximum column width.

Important Information and Disclaimer: The information provided on this page represents TI's knowledge and belief as of the date that it is provided. TI bases its knowledge and belief on information provided by third parties, and makes no representation or warranty as to the accuracy of such information. Efforts are underway to better integrate information from third parties. TI has taken and continues to take reasonable steps to provide representative and accurate information but may not have conducted destructive testing or chemical analysis on incoming materials and chemicals. TI and TI suppliers consider certain information to be proprietary, and thus CAS numbers and other limited information may not be available for release.

In no event shall TI's liability arising out of such information exceed the total purchase price of the TI part(s) at issue in this document sold by TI to Customer on an annual basis.

TAPE AND REEL INFORMATION

QUADRANT ASSIGNMENTS FOR PIN 1 ORIENTATION IN TAPE

*All dimensions are nominal

Device	Package Type	Package Drawing	Pins	SPQ	Reel Diameter (mm)	Reel Width W1 (mm)	A0 (mm)	B0 (mm)	K0 (mm)	P1 (mm)	W (mm)	Pin1 Quadrant
OPA2237EA/250	VSSOP	DGK	8	250	180.0	12.4	5.3	3.4	1.4	8.0	12.0	Q1
OPA2237EA/2K5	VSSOP	DGK	8	2500	330.0	12.4	5.3	3.4	1.4	8.0	12.0	Q1
OPA2237UA/2K5	SOIC	D	8	2500	330.0	12.4	6.4	5.2	2.1	8.0	12.0	Q1
OPA237NA/250	SOT-23	DBV	5	250	178.0	9.0	3.3	3.2	1.4	4.0	8.0	Q3
OPA237NA/3K	SOT-23	DBV	5	3000	178.0	9.0	3.3	3.2	1.4	4.0	8.0	Q3
OPA237UA/2K5	SOIC	D	8	2500	330.0	12.4	6.4	5.2	2.1	8.0	12.0	Q1

TAPE AND REEL BOX DIMENSIONS



*All dimensions are nominal

Device	Package Type	Package Drawing	Pins	SPQ	Length (mm)	Width (mm)	Height (mm)
OPA2237EA/250	VSSOP	DGK	8	250	210.0	185.0	35.0
OPA2237EA/2K5	VSSOP	DGK	8	2500	367.0	367.0	35.0
OPA2237UA/2K5	SOIC	D	8	2500	367.0	367.0	35.0
OPA237NA/250	SOT-23	DBV	5	250	180.0	180.0	18.0
OPA237NA/3K	SOT-23	DBV	5	3000	180.0	180.0	18.0
OPA237UA/2K5	SOIC	D	8	2500	367.0	367.0	35.0



D0008A

PACKAGE OUTLINE

SOIC - 1.75 mm max height

SMALL OUTLINE INTEGRATED CIRCUIT



4214825/C 02/2019

NOTES:

- Linear dimensions are in inches [millimeters]. Dimensions in parenthesis are for reference only. Controlling dimensions are in inches. Dimensioning and tolerancing per ASME Y14.5M.
- This drawing is subject to change without notice.
- This dimension does not include mold flash, protrusions, or gate burrs. Mold flash, protrusions, or gate burrs shall not exceed $.006$ [0.15] per side.
- This dimension does not include interlead flash.
- Reference JEDEC registration MS-012, variation AA.

EXAMPLE BOARD LAYOUT

D0008A

SOIC - 1.75 mm max height

SMALL OUTLINE INTEGRATED CIRCUIT



LAND PATTERN EXAMPLE
 EXPOSED METAL SHOWN
 SCALE:8X



SOLDER MASK DETAILS

4214825/C 02/2019

NOTES: (continued)

- 6. Publication IPC-7351 may have alternate designs.
- 7. Solder mask tolerances between and around signal pads can vary based on board fabrication site.

EXAMPLE STENCIL DESIGN

D0008A

SOIC - 1.75 mm max height

SMALL OUTLINE INTEGRATED CIRCUIT



SOLDER PASTE EXAMPLE
BASED ON .005 INCH [0.125 MM] THICK STENCIL
SCALE:8X

4214825/C 02/2019

NOTES: (continued)

8. Laser cutting apertures with trapezoidal walls and rounded corners may offer better paste release. IPC-7525 may have alternate design recommendations.
9. Board assembly site may have different recommendations for stencil design.

EXAMPLE BOARD LAYOUT

DBV0005A

SOT-23 - 1.45 mm max height

SMALL OUTLINE TRANSISTOR



LAND PATTERN EXAMPLE
EXPOSED METAL SHOWN
SCALE:15X



SOLDER MASK DETAILS

4214839/D 11/2018

NOTES: (continued)

- 5. Publication IPC-7351 may have alternate designs.
- 6. Solder mask tolerances between and around signal pads can vary based on board fabrication site.

EXAMPLE STENCIL DESIGN

DBV0005A

SOT-23 - 1.45 mm max height

SMALL OUTLINE TRANSISTOR



SOLDER PASTE EXAMPLE
BASED ON 0.125 mm THICK STENCIL
SCALE:15X

4214839/D 11/2018

NOTES: (continued)

7. Laser cutting apertures with trapezoidal walls and rounded corners may offer better paste release. IPC-7525 may have alternate design recommendations.
8. Board assembly site may have different recommendations for stencil design.



- NOTES:
- A. All linear dimensions are in millimeters.
 - B. This drawing is subject to change without notice.
 - C. Publication IPC-7351 is recommended for alternate designs.
 - D. Laser cutting apertures with trapezoidal walls and also rounding corners will offer better paste release. Customers should contact their board assembly site for stencil design recommendations. Refer to IPC-7525 for other stencil recommendations.
 - E. Customers should contact their board fabrication site for solder mask tolerances between and around signal pads.

IMPORTANT NOTICE AND DISCLAIMER

TI PROVIDES TECHNICAL AND RELIABILITY DATA (INCLUDING DATASHEETS), DESIGN RESOURCES (INCLUDING REFERENCE DESIGNS), APPLICATION OR OTHER DESIGN ADVICE, WEB TOOLS, SAFETY INFORMATION, AND OTHER RESOURCES "AS IS" AND WITH ALL FAULTS, AND DISCLAIMS ALL WARRANTIES, EXPRESS AND IMPLIED, INCLUDING WITHOUT LIMITATION ANY IMPLIED WARRANTIES OF MERCHANTABILITY, FITNESS FOR A PARTICULAR PURPOSE OR NON-INFRINGEMENT OF THIRD PARTY INTELLECTUAL PROPERTY RIGHTS.

These resources are intended for skilled developers designing with TI products. You are solely responsible for (1) selecting the appropriate TI products for your application, (2) designing, validating and testing your application, and (3) ensuring your application meets applicable standards, and any other safety, security, or other requirements. These resources are subject to change without notice. TI grants you permission to use these resources only for development of an application that uses the TI products described in the resource. Other reproduction and display of these resources is prohibited. No license is granted to any other TI intellectual property right or to any third party intellectual property right. TI disclaims responsibility for, and you will fully indemnify TI and its representatives against, any claims, damages, costs, losses, and liabilities arising out of your use of these resources.

TI's products are provided subject to TI's Terms of Sale (www.ti.com/legal/termsofsale.html) or other applicable terms available either on ti.com or provided in conjunction with such TI products. TI's provision of these resources does not expand or otherwise alter TI's applicable warranties or warranty disclaimers for TI products.

Mailing Address: Texas Instruments, Post Office Box 655303, Dallas, Texas 75265
Copyright © 2019, Texas Instruments Incorporated

Looking for pricing, stock, or lifecycle information?

Click below to explore more details on WIN SOURCE:

 [View OPA237NA/3KG4 on WIN SOURCE](#)

 [Texas Instruments](#) Information

Optimize Your Supply Chain with WIN SOURCE Solutions

-  Global Sourcing Solution
-  Obsolete Management
-  Cost Control Management
-  Shortage Management
-  Alternative Solution
-  Excess Inventory Management