



**THE DATASHEET OF  
MZA3216Y241B**



# Chip Beads(SMD Array) For General Signal Line

Conformity to RoHS Directive

## MZA Series MZA3216 Type

### FEATURES

- A single MZA series chip provides noise attenuation for four lines, making it ideal for use with I/O lines of various highly miniaturized.
- Electronic equipment, such as portable products, which comprise high density circuitry.
- Low crosstalk between adjacent circuits.
- Internal electrodes feature low DC resistance, minimizing wasteful power consumption.
- Electroplated terminal electrodes accommodate reflow soldering.
- Monolithic structure ensures high reliability.
- The products contain no lead and also support lead-free soldering.
- It is a product conforming to RoHS directive.

### APPLICATIONS

High-frequency noise countermeasure in computers, printers, VCRs, televisions, portable telephones, and other equipment.

### PRODUCT IDENTIFICATION

MZA 3216 R 121 A T  
 (1) (2) (3) (4) (5) (6)

- (1) Series name  
 (2) Dimensions L×W  
 (3) Material code  
 (4) Nominal impedance  
 121:120Ω at 100MHz  
 (5) Characteristic type  
 (6) Packaging style  
 T:Taping

### RECOMMENDED SOLDERING CONDITION

#### REFLOW SOLDERING

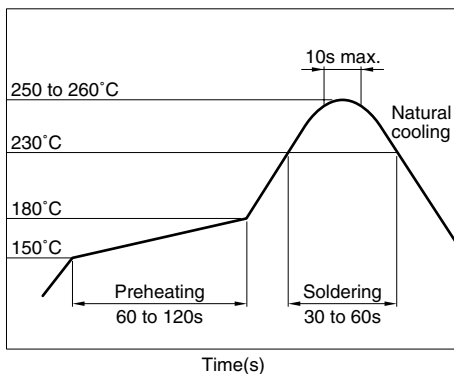

### SHAPES AND DIMENSIONS/RECOMMENDED PC BOARD PATTERN (REFLOW SOLDERING)

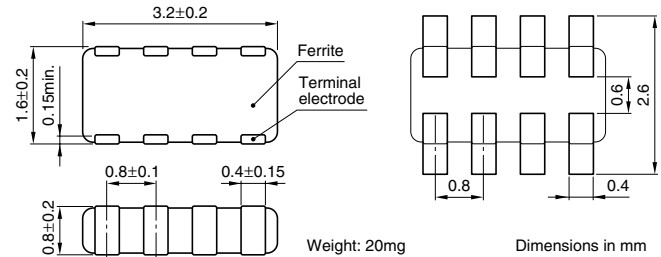

### TEMPERATURE RANGES

Operating/storage	-55 to +125°C
-------------------	---------------



### PACKAGING STYLE AND QUANTITIES

Packaging style	Quantity
Taping	4000 pieces/reel

### HANDLING AND PRECAUTIONS

- Before soldering, be sure to preheat components. The preheating temperature should be set so that the temperature difference between the solder temperature and product temperature does not exceed 150°C.
- After mounting components onto the printed circuit board, do not apply stress through board bending or mishandling.
- Do not expose the inductors to stray magnetic fields.
- Avoid static electricity discharge during handling.
- When hand soldering, apply the soldering iron to the printed circuit board only. Temperature of the iron tip should not exceed 350°C. Soldering time should not exceed 3 seconds.
- This product does not apply to flow soldering construction method.

• Conformity to RoHS Directive: This means that, in conformity with EU Directive 2002/95/EC, lead, cadmium, mercury, hexavalent chromium, and specific bromine-based flame retardants, PBB and PBDE, have not been used, except for exempted applications.

• Please contact our Sales office when your application are considered the following:  
 The device's failure or malfunction may directly endanger human life (e.g. application for automobile/aircraft/medical/nuclear power devices, etc.)

• All specifications are subject to change without notice.

## ELECTRICAL CHARACTERISTICS

Part No.	Impedance( $\Omega$ ) $\pm 25\%$ [100MHz]*	DC resistance ( $\Omega$ )max.	Rated current (mA)max.	Rated voltage (V)max.
MZA3216R121A	120	0.18	250	5
MZA3216R301A	300	0.4	200	5
MZA3216R601A	600	0.45	200	5
MZA3216R102A	1000	0.6	150	5
MZA3216S600A	60	0.2	300	5
MZA3216S121A	120	0.2	250	5
MZA3216S301A	300	0.4	200	5
MZA3216S601A	600	0.5	200	5
MZA3216Y600B	60	0.2	300	5
MZA3216Y121B	120	0.2	250	5
MZA3216Y241B	240	0.3	200	5
MZA3216Y601B	600	0.5	200	5
MZA3216Y102B	1000	0.6	150	5
MZA3216D121C	120	0.45	200	5
MZA3216D241C	240	0.6	150	5
MZA3216D301C	300	0.8	100	5

\* Test equipment: E4991A or equivalent

Test tool: 16192A or equivalent

Test temperature:  $25 \pm 10^\circ\text{C}$

## TYPICAL ELECTRICAL CHARACTERISTICS

### Z, X, R vs. FREQUENCY CHARACTERISTICS

**MZA3216R121A**

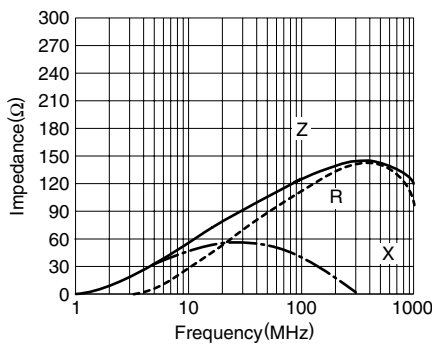

**MZA3216R301A**

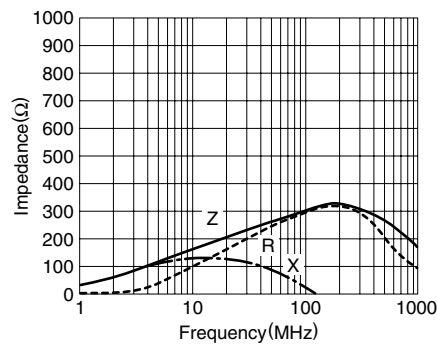

**MZA3216R601A**

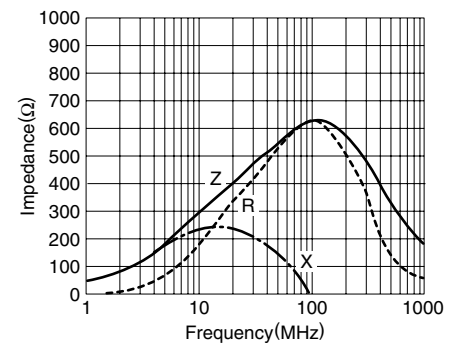

**MZA3216R102A**

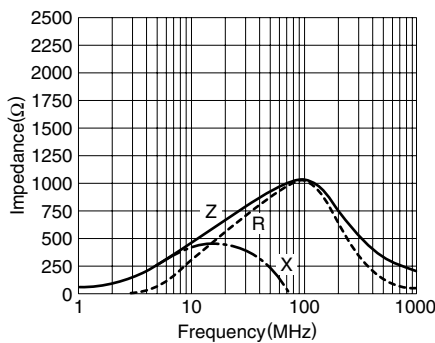

**MZA3216S600A**

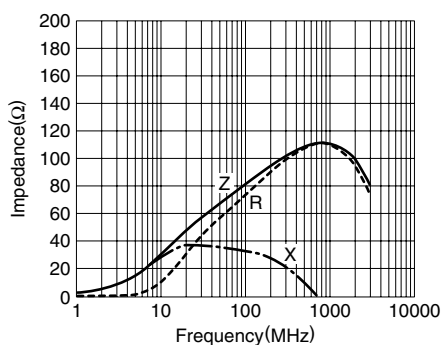

**MZA3216S121A**

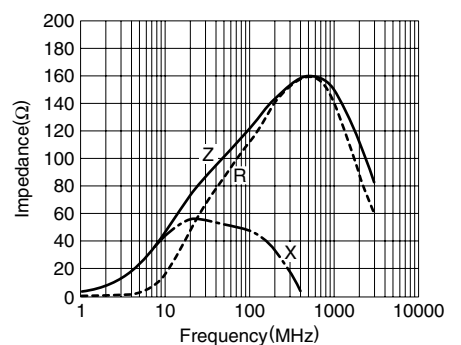

**MZA3216S301A**

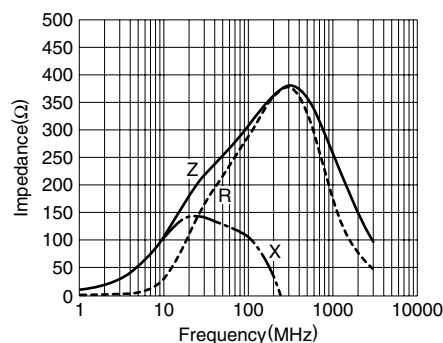

**MZA3216S601A**

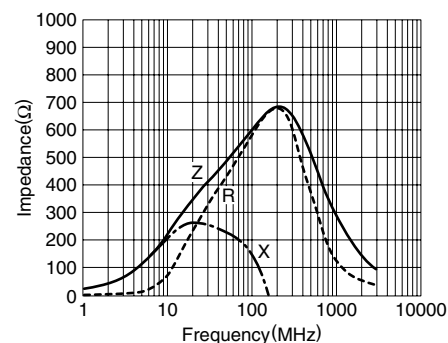

**MZA3216Y600B**

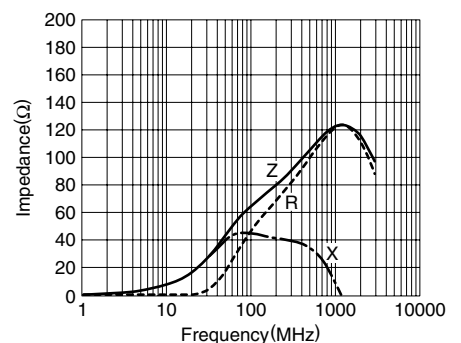

• All specifications are subject to change without notice.

### TYPICAL ELECTRICAL CHARACTERISTICS

#### Z, X, R vs. FREQUENCY CHARACTERISTICS

##### MZA3216Y121B

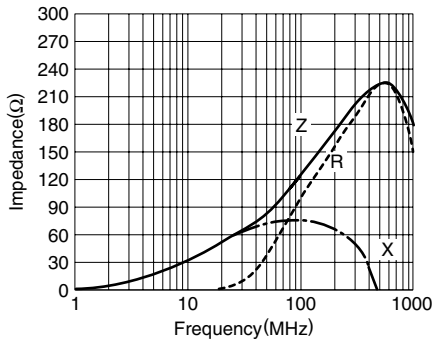

##### MZA3216Y241B

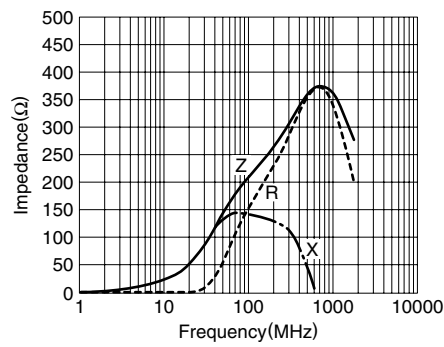

##### MZA3216Y601B

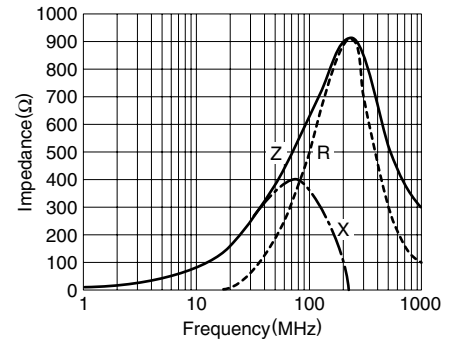

##### MZA3216Y102B

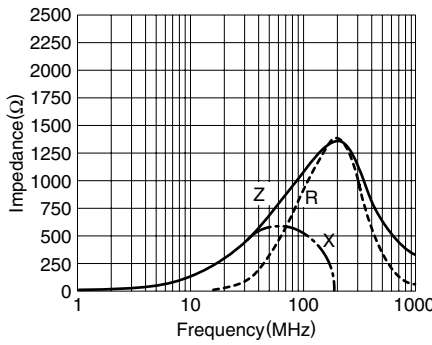

##### MZA3216D121C

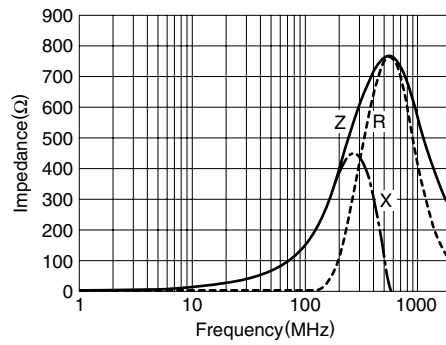

##### MZA3216D241C

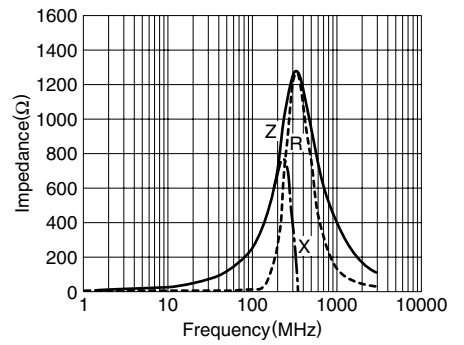

##### MZA3216D301C

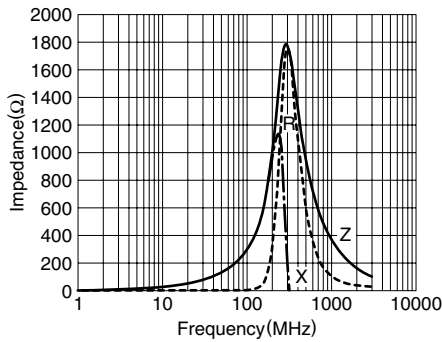

### PACKAGING STYLES

#### REEL DIMENSIONS

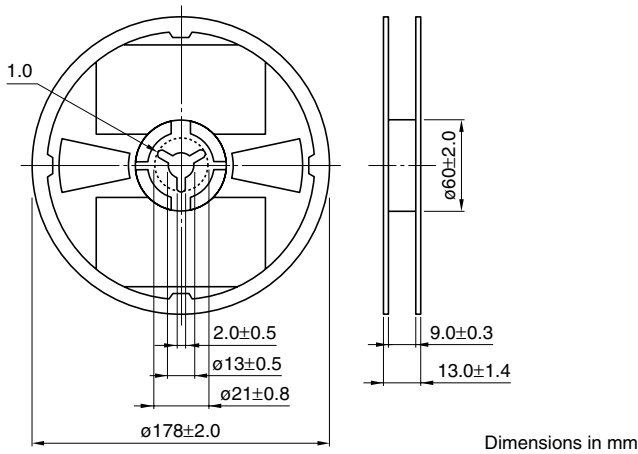

#### TAPE DIMENSIONS

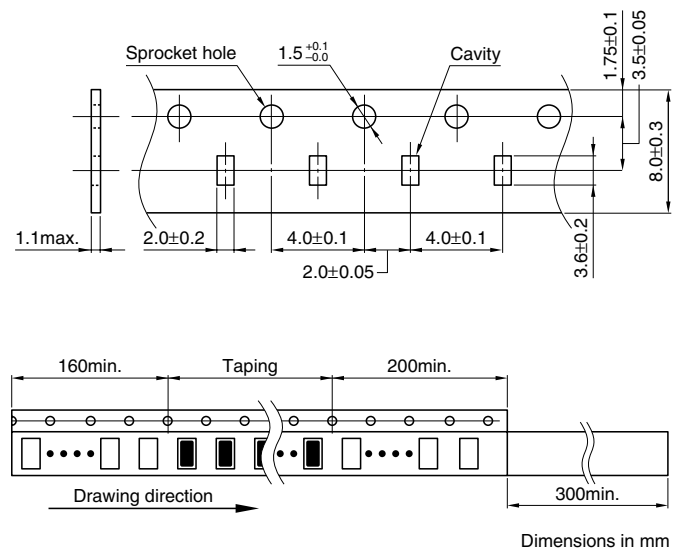

• All specifications are subject to change without notice.

## Looking for pricing, stock, or lifecycle information?

Click below to explore more details on WIN SOURCE:

 [View MZA3216Y241B](#) on WIN SOURCE

 [TDK Corporation](#) Information

## Optimize Your Supply Chain with WIN SOURCE Solutions

-  Global Sourcing Solution
-  Obsolete Management
-  Cost Control Management
-  Shortage Management
-  Alternative Solution
-  Excess Inventory Management