



# THE DATASHEET OF LM324KANSR



# LMx24, LMx24x, LMx24xx, LM2902, LM2902x, LM2902xx, LM2902xxx Quadruple Operational Amplifiers

## 1 Features

- 2-kV ESD Protection for:
  - LM224K, LM224KA
  - LM324K, LM324KA
  - LM2902K, LM2902KV, LM2902KAV
- Wide Supply Ranges
  - Single Supply: 3 V to 32 V (26 V for LM2902)
  - Dual Supplies:  $\pm 1.5$  V to  $\pm 16$  V ( $\pm 13$  V for LM2902)
- Low Supply-Current Drain Independent of Supply Voltage: 0.8 mA Typical
- Common-Mode Input Voltage Range Includes Ground, Allowing Direct Sensing Near Ground
- Low Input Bias and Offset Parameters
  - Input Offset Voltage: 3 mV Typical  
A Versions: 2 mV Typical
  - Input Offset Current: 2 nA Typical
  - Input Bias Current: 20 nA Typical  
A Versions: 15 nA Typical
- Differential Input Voltage Range Equal to Maximum-Rated Supply Voltage: 32 V (26 V for LM2902)
- Open-Loop Differential Voltage Amplification: 100 V/mV Typical
- Internal Frequency Compensation
- On Products Compliant to MIL-PRF-38535, All Parameters are Tested Unless Otherwise Noted. On All Other Products, Production Processing Does Not Necessarily Include Testing of All Parameters.

## 2 Applications

- Blu-ray Players and Home Theaters
- Chemical and Gas Sensors
- DVD Recorders and Players
- Digital Multimeter: Bench and Systems
- Digital Multimeter: Handhelds
- Field Transmitter: Temperature Sensors
- Motor Control: AC Induction, Brushed DC, Brushless DC, High-Voltage, Low-Voltage, Permanent Magnet, and Stepper Motor
- Oscilloscopes
- TV: LCD and Digital
- Temperature Sensors or Controllers Using Modbus
- Weigh Scales

## 3 Description

These devices consist of four independent high-gain frequency-compensated operational amplifiers that are designed specifically to operate from a single supply or split supply over a wide range of voltages.

### Device Information<sup>(1)</sup>

| PART NUMBER  | PACKAGE    | BODY SIZE (NOM)    |
|--|------------|--------------------|
| LMx24, LMx24x,<br>LMx24xx, LM2902,<br>LM2902x,<br>LM2902xx,<br>LM2902xxx | SOIC (14)  | 8.65 mm x 3.91 mm  |
|  | CDIP (14)  | 19.56 mm x 6.67 mm |
|  | PDIP (14)  | 19.30 mm x 6.35 mm |
|  | CFP (14)   | 9.21 mm x 5.97 mm  |
|  | TSSOP (14) | 5.00 mm x 4.40 mm  |
|  | SO (14)    | 9.20 mm x 5.30 mm  |
|  | SSOP (14)  | 6.20 mm x 5.30 mm  |
| LM124, LM124A  | LCCC (20)  | 8.90 mm x 8.90 mm  |

(1) For all available packages, see the orderable addendum at the end of the data sheet.

### Symbol (Each Amplifier)

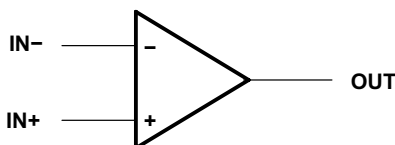

## Table of Contents

|   |           |  |           |
|---|-----------|--|-----------|
| <b>1 Features</b> .....                                     | <b>1</b>  | 8.1 Overview .....   | 10        |
| <b>2 Applications</b> .....                                 | <b>1</b>  | 8.2 Functional Block Diagram .....                               | 10        |
| <b>3 Description</b> .....                                  | <b>1</b>  | 8.3 Feature Description .....                                    | 11        |
| <b>4 Revision History</b> .....                             | <b>2</b>  | 8.4 Device Functional Modes .....                                | 11        |
| <b>5 Pin Configuration and Functions</b> .....              | <b>3</b>  | <b>9 Application and Implementation</b> .....                    | <b>12</b> |
| <b>6 Specifications</b> .....                               | <b>4</b>  | 9.1 Application Information .....                                | 12        |
| 6.1 Absolute Maximum Ratings .....                          | 4         | 9.2 Typical Application .....                                    | 12        |
| 6.2 ESD Ratings .....                                       | 4         | <b>10 Power Supply Recommendations</b> .....                     | <b>13</b> |
| 6.3 Recommended Operating Conditions .....                  | 4         | <b>11 Layout</b> .....   | <b>13</b> |
| 6.4 Thermal Information .....                               | 5         | 11.1 Layout Guidelines .....                                     | 13        |
| 6.5 Electrical Characteristics for LMx24 and LM324K ....    | 5         | 11.2 Layout Examples .....                                       | 14        |
| 6.6 Electrical Characteristics for LM2902 and LM2902V       | 6         | <b>12 Device and Documentation Support</b> .....                 | <b>15</b> |
| 6.7 Electrical Characteristics for LMx24A and LM324KA ..... | 6         | 12.1 Documentation Support .....                                 | 15        |
| 6.8 Operating Conditions .....                              | 7         | 12.2 Related Links .....   | 15        |
| 6.9 Typical Characteristics .....                           | 8         | 12.3 Trademarks .....  | 15        |
| <b>7 Parameter Measurement Information</b> .....            | <b>9</b>  | 12.4 Electrostatic Discharge Caution .....                       | 15        |
| <b>8 Detailed Description</b> .....                         | <b>10</b> | 12.5 Glossary .....  | 15        |
|   |           | <b>13 Mechanical, Packaging, and Orderable Information</b> ..... | <b>15</b> |

## 4 Revision History

NOTE: Page numbers for previous revisions may differ from page numbers in the current version.

| Changes from Revision V (January 2014) to Revision W                          | Page |
|---|------|
| • Added <i>Applications</i> .....   | 1    |
| • Added <i>Device Information</i> table .....                                 | 1    |
| • Added <i>Device and Documentation Support</i> section .....                 | 15   |
| • Added <i>Mechanical, Packaging, and Orderable Information</i> section ..... | 15   |

| Changes from Revision U (August 2010) to Revision V                             | Page |
|---|------|
| • Updated document to new TI data sheet format - no specification changes ..... | 1    |
| • Updated <i>Features</i> .....   | 1    |
| • Removed <i>Ordering Information</i> table .....                               | 3    |
| • Added ESD warning .....   | 15   |

## 5 Pin Configuration and Functions



**D, DB, J, N, NS, PW, W  
14-Pin SOIC, SSOP, CDIP, PDIP, SO, TSSOP, CFP  
(Top View)**

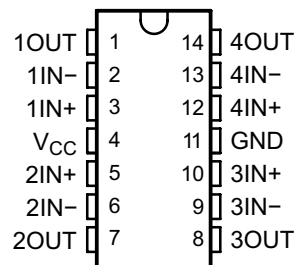

### Pin Functions

| PIN             |          | SOIC, SSOP,<br>CDIP, PDIP,<br>SO, TSSOP,<br>CFP NO. | I/O | DESCRIPTION    |
|-----------------|----------|---|-----|----------------|
| NAME            | LCCC NO. |   |     |                |
| 1IN-            | 3        | 2   | I   | Negative input |
| 1IN+            | 4        | 3   | I   | Positive input |
| 1OUT            | 2        | 1   | O   | Output         |
| 2IN-            | 9        | 6   | I   | Negative input |
| 2IN+            | 8        | 5   | I   | Positive input |
| 2OUT            | 10       | 7   | O   | Output         |
| 3IN-            | 13       | 9   | I   | Negative input |
| 3IN+            | 14       | 10  | I   | Positive input |
| 3OUT            | 12       | 8   | O   | Output         |
| 4IN-            | 19       | 13  | I   | Negative input |
| 4IN+            | 18       | 12  | I   | Positive input |
| 4OUT            | 20       | 14  | O   | Output         |
| GND             | 16       | 11  | —   | Ground         |
| NC              | 1        | —   | —   | Do not connect |
|                 | 5        |   |     |                |
|                 | 7        |   |     |                |
|                 | 11       |   |     |                |
|                 | 15       |   |     |                |
| V <sub>CC</sub> | 17       | 4   | —   | Power supply   |
|                 | 6        |   |     |                |

## 6 Specifications

### 6.1 Absolute Maximum Ratings

over operating free-air temperature range (unless otherwise noted)<sup>(1)</sup>

|  | LM2902         |     | LMx24, LMx24x,<br>LMx24xx, LM2902x,<br>LM2902xx, LM2902xxx |       | UNIT |
|--|----------------|-----|--|-------|------|
|  | MIN            | MAX | MIN  | MAX   |      |
| Supply voltage, $V_{CC}$ <sup>(2)</sup>  | ±13            | 26  | ±16  | 32    | V    |
| Differential input voltage, $V_{ID}$ <sup>(3)</sup>  |                | ±26 |  | ±32   | V    |
| Input voltage, $V_I$ (either input)  | –0.3           | 26  | –0.3   | to 32 | V    |
| Duration of output short circuit (one amplifier) to ground at (or below) $T_A = 25^\circ\text{C}$ , $V_{CC} \leq 15\text{ V}$ <sup>(4)</sup> | Unlimited      |     | Unlimited  |       |      |
| Operating virtual junction temperature, $T_J$  | 150            |     | 150  |       | °C   |
| Case temperature for 60 seconds  | FK package     |     | 260  |       | °C   |
| Lead temperature 1.6 mm (1/16 inch) from case for 60 seconds   | J or W package |     | 300  |       | °C   |
| Storage temperature, $T_{stg}$   | –65            | 150 | –65  | 150   | °C   |

- (1) Stresses beyond those listed under *Absolute Maximum Ratings* may cause permanent damage to the device. These are stress ratings only, and functional operation of the device at these or any other conditions beyond those indicated under *Recommended Operating Conditions* is not implied. Exposure to absolute-maximum-rated conditions for extended periods may affect device reliability.
- (2) All voltage values (except differential voltages and  $V_{CC}$  specified for the measurement of  $I_{OS}$ ) are with respect to the network GND.
- (3) Differential voltages are at IN+, with respect to IN–.
- (4) Short circuits from outputs to VCC can cause excessive heating and eventual destruction.

### 6.2 ESD Ratings

|   |   | VALUE | UNIT |
|---|---|-------|------|
| <b>LM224K, LM224KA, LM324K, LM324KA, LM2902K, LM2902KV, LM2902KAV</b> |   |       |      |
| $V_{(ESD)}$ Electrostatic discharge                                   | Human-body model (HBM), per ANSI/ESDA/JEDEC JS-001 <sup>(1)</sup> | ±2000 | V    |
|   | Charged-device model (CDM), per JEDEC specification JESD22-C101   | ±1000 |      |
| <b>LM124, LM124A, LM224, LM224A, LM324, LM324A, LM2902, LM2902V</b>   |   |       |      |
| $V_{(ESD)}$ Electrostatic discharge                                   | Human-body model (HBM), per ANSI/ESDA/JEDEC JS-001 <sup>(1)</sup> | ±500  | V    |
|   | Charged-device model (CDM), per JEDEC specification JESD22-C101   | ±1000 |      |

- (1) JEDEC document JEP155 states that 500-V HBM allows safe manufacturing with a standard ESD control process.

### 6.3 Recommended Operating Conditions

over operating free-air temperature range (unless otherwise noted)

|                                      | LM2902 |              | LMx24, LMx24x, LMx24xx,<br>LM2902x, LM2902xx, LM2902xxx |              | UNIT |
|--------------------------------------|--------|--------------|---|--------------|------|
|                                      | MIN    | MAX          | MIN   | MAX          |      |
| $V_{CC}$ Supply voltage              | 3      | 26           | 3   | 30           | V    |
| $V_{CM}$ Common-mode voltage         | 0      | $V_{CC} - 2$ | 0   | $V_{CC} - 2$ | V    |
| $T_A$ Operating free air temperature | LM124  |              | –55   | 125          | °C   |
|                                      | LM2904 | –40          | 125   |              |      |
|                                      | LM324  |              | 0   | 70           |      |
|                                      | LM224  |              | –25   | 85           |      |

## 6.4 Thermal Information

| THERMAL METRIC <sup>(1)</sup>  | LMx24, LM2902 |           |          |         |            | LMx24     |          |         | UNIT |
|--|---------------|-----------|----------|---------|------------|-----------|----------|---------|------|
|  | D (SOIC)      | DB (SSOP) | N (PDIP) | NS (SO) | PW (TSSOP) | FK (LCCC) | J (CDIP) | W (CFP) |      |
|  | 14 PINS       | 14 PINS   | 14 PINS  | 14 PINS | 14 PINS    | 20 PINS   | 14 PINS  | 14 PINS |      |
| $R_{\theta JA}$ <sup>(2)(3)</sup> Junction-to-ambient thermal resistance | 86            | 86        | 80       | 76      | 113        | —         | —        | —       | °C/W |
| $R_{\theta JC}$ <sup>(4)</sup> Junction-to-case (top) thermal resistance | —             | —         | —        | —       | —          | 5.61      | 15.05    | 14.65   |      |

- (1) For more information about traditional and new thermal metrics, see the *IC Package Thermal Metrics* application report, [SPRA953](#).
- (2) Short circuits from outputs to VCC can cause excessive heating and eventual destruction.
- (3) Maximum power dissipation is a function of  $T_{J(max)}$ ,  $R_{\theta JA}$ , and  $T_A$ . The maximum allowable power dissipation at any allowable ambient temperature is  $P_D = (T_{J(max)} - T_A)/R_{\theta JA}$ . Operating at the absolute maximum  $T_J$  of 150°C can affect reliability.
- (4) Maximum power dissipation is a function of  $T_{J(max)}$ ,  $R_{\theta JA}$ , and  $T_C$ . The maximum allowable power dissipation at any allowable case temperature is  $P_D = (T_{J(max)} - T_C)/R_{\theta JC}$ . Operating at the absolute maximum  $T_J$  of 150°C can affect reliability.

## 6.5 Electrical Characteristics for LMx24 and LM324K

at specified free-air temperature,  $V_{CC} = 5\text{ V}$  (unless otherwise noted)

| PARAMETER  | TEST CONDITIONS <sup>(1)</sup>  | $T_A$ <sup>(2)</sup> | LM124, LM224                             |                    |     | LM324, LM324K                            |                    |       | UNIT          |    |
|--|---|----------------------|--|--------------------|-----|--|--------------------|-------|---------------|----|
|  |   |                      | MIN                                      | TYP <sup>(3)</sup> | MAX | MIN                                      | TYP <sup>(3)</sup> | MAX   |               |    |
| $V_{IO}$ Input offset voltage  | $V_{CC} = 5\text{ V to MAX}$ , $V_{IC} = V_{ICRmin}$ ,<br>$V_O = 1.4\text{ V}$              | 25°C<br>Full range   | 3 5 7                                    |                    |     | 3 7 9                                    |                    |       | mV            |    |
| $I_{IO}$ Input offset current  | $V_O = 1.4\text{ V}$  | 25°C<br>Full range   | 2 30 100                                 |                    |     | 2 150                                    |                    |       | nA            |    |
| $I_{IB}$ Input bias current  | $V_O = 1.4\text{ V}$  | 25°C<br>Full range   | -20 -150 -300                            |                    |     | -20 -250 -500                            |                    |       | nA            |    |
| $V_{ICR}$ Common-mode input voltage range                                  | $V_{CC} = 5\text{ V to MAX}$  | 25°C<br>Full range   | 0 to $V_{CC} - 1.5$<br>0 to $V_{CC} - 2$ |                    |     | 0 to $V_{CC} - 1.5$<br>0 to $V_{CC} - 2$ |                    |       | V             |    |
| $V_{OH}$ High-level output voltage   | $R_L = 2\text{ k}\Omega$  | 25°C                 | $V_{CC} - 1.5$                           |                    |     | $V_{CC} - 1.5$                           |                    |       | V             |    |
|  | $R_L = 10\text{ k}\Omega$   | 25°C                 |  |                    |     |  |                    |       |               |    |
|  | $V_{CC} = \text{MAX}$   | Full range           | 26                                       | 28                 |     | 26                                       |                    | 27 28 |               |    |
| $V_{OL}$ Low-level output voltage  | $R_L \leq 10\text{ k}\Omega$  | Full range           | 5 20                                     |                    |     | 5 20                                     |                    |       | mV            |    |
| $A_{VD}$ Large-signal differential voltage amplification                   | $V_{CC} = 15\text{ V}$ , $V_O = 1\text{ V to }11\text{ V}$ ,<br>$R_L \geq 2\text{ k}\Omega$ | 25°C                 | 50 100                                   |                    |     | 25 100                                   |                    |       | V/mV          |    |
|  |   | Full range           | 25                                       |                    |     | 15                                       |                    |       |               |    |
| CMRR Common-mode rejection ratio   | $V_{IC} = V_{ICRmin}$   | 25°C                 | 70 80                                    |                    |     | 65 80                                    |                    |       | dB            |    |
| $k_{SVR}$ Supply-voltage rejection ratio ( $\Delta V_{CC}/\Delta V_{IO}$ ) |   | 25°C                 | 65 100                                   |                    |     | 65 100                                   |                    |       | dB            |    |
| $V_{O1}/V_{O2}$ Crosstalk attenuation                                      | $f = 1\text{ kHz to }20\text{ kHz}$   | 25°C                 | 120                                      |                    |     | 120                                      |                    |       | dB            |    |
| $I_O$ Output current   | $V_{CC} = 15\text{ V}$ ,<br>$V_{ID} = 1\text{ V}$ ,<br>$V_O = 0$                            | Source               | 25°C                                     | -20 -30 -60        |     |  | -20 -30 -60        |       |               | mA |
|  |   | Full range           | -10                                      |                    |     | -10                                      |                    |       |               |    |
|  | Sink  | 25°C                 | 10 20                                    |                    |     | 10 20                                    |                    |       |               |    |
|  |   | Full range           | 5  |                    |     | 5  |                    |       |               |    |
|  | $V_{ID} = -1\text{ V}$ , $V_O = 200\text{ mV}$  | 25°C                 | 12 30                                    |                    |     | 12 30                                    |                    |       | $\mu\text{A}$ |    |
| $I_{OS}$ Short-circuit output current                                      | $V_{CC}$ at 5 V, $V_O = 0$ ,<br>GND at -5 V   | 25°C                 | $\pm 40$ $\pm 60$                        |                    |     | $\pm 40$ $\pm 60$                        |                    |       | mA            |    |
| $I_{CC}$ Supply current (four amplifiers)                                  | $V_O = 2.5\text{ V}$ , no load  | Full range           | 0.7 1.2                                  |                    |     | 0.7 1.2                                  |                    |       | mA            |    |
|  | $V_{CC} = \text{MAX}$ , $V_O = 0.5 V_{CC}$ ,<br>no load                                     | Full range           | 1.4 3                                    |                    |     | 1.4 3                                    |                    |       |               |    |

- (1) All characteristics are measured under open-loop conditions, with zero common-mode input voltage, unless otherwise specified. MAX  $V_{CC}$  for testing purposes is 26 V for LM2902 and 30 V for the others.
- (2) Full range is -55°C to 125°C for LM124, -25°C to 85°C for LM224, and 0°C to 70°C for LM324.
- (3) All typical values are at  $T_A = 25^\circ\text{C}$

## 6.6 Electrical Characteristics for LM2902 and LM2902V

at specified free-air temperature,  $V_{CC} = 5\text{ V}$  (unless otherwise noted)

| PARAMETER  | TEST CONDITIONS <sup>(1)</sup>   |  | $T_A$ <sup>(2)</sup> | LM2902              |                    |     | LM2902V             |                    |     | UNIT                         |
|--|--|--|----------------------|---------------------|--------------------|-----|---------------------|--------------------|-----|------------------------------|
|  |  |  |                      | MIN                 | TYP <sup>(3)</sup> | MAX | MIN                 | TYP <sup>(3)</sup> | MAX |                              |
| $V_{IO}$ Input offset voltage  | $V_{CC} = 5\text{ V to MAX,}$<br>$V_{IC} = V_{ICRmin},$<br>$V_O = 1.4\text{ V}$              | Non-A-suffix devices                                     | 25°C                 | 3 7                 |                    |     | 3 7                 |                    |     | mV                           |
|  |  |  | Full range           | 10                  |                    |     | 10                  |                    |     |                              |
|  |  | A-suffix devices   | 25°C                 |                     |                    |     | 1 2                 |                    |     |                              |
|  |  |  | Full range           |                     |                    |     | 4                   |                    |     |                              |
| $\Delta V_{IO}/\Delta T$ Input offset voltage temperature drift            | $R_S = 0\ \Omega$  |  | Full range           |                     |                    |     | 7                   |                    |     | $\mu\text{V}/^\circ\text{C}$ |
| $I_{IO}$ Input offset current  | $V_O = 1.4\text{ V}$   |  | 25°C                 | 2 50                |                    |     | 2 50                |                    |     | nA                           |
|  |  |  | Full range           | 300                 |                    |     | 150                 |                    |     |                              |
| $\Delta I_{IO}/\Delta T$ Input offset voltage temperature drift            |  |  | Full range           |                     |                    |     | 10                  |                    |     | $\text{pA}/^\circ\text{C}$   |
| $I_{IB}$ Input bias current  | $V_O = 1.4\text{ V}$   |  | 25°C                 | -20 -250            |                    |     | -20 -250            |                    |     | nA                           |
|  |  |  | Full range           | -500                |                    |     | -500                |                    |     |                              |
| $V_{ICR}$ Common-mode input voltage range                                  | $V_{CC} = 5\text{ V to MAX}$   |  | 25°C                 | 0 to $V_{CC} - 1.5$ |                    |     | 0 to $V_{CC} - 1.5$ |                    |     | V                            |
|  |  |  | Full range           | 0 to $V_{CC} - 2$   |                    |     | 0 to $V_{CC} - 2$   |                    |     |                              |
| $V_{OH}$ High-level output voltage   | $R_L = 2\text{ k}\Omega$<br>$R_L = 10\text{ k}\Omega$<br>$V_{CC} = \text{MAX}$               |  | 25°C                 |                     |                    |     |                     |                    |     | V                            |
|  |  |  | 25°C                 | $V_{CC} - 1.5$      |                    |     | $V_{CC} - 1.5$      |                    |     |                              |
|  |  | $R_L = 2\text{ k}\Omega$<br>$R_L \geq 10\text{ k}\Omega$ | Full range           | 22                  |                    |     | 26                  |                    |     |                              |
|  |  |  | Full range           | 23 24               |                    |     | 27                  |                    |     |                              |
| $V_{OL}$ Low-level output voltage  | $R_L \leq 10\text{ k}\Omega$   |  | Full range           | 5 20                |                    |     | 5 20                |                    |     | mV                           |
| $A_{VD}$ Large-signal differential voltage amplification                   | $V_{CC} = 15\text{ V,}$<br>$V_O = 1\text{ V to }11\text{ V,}$<br>$R_L \geq 2\text{ k}\Omega$ |  | 25°C                 | 25 100              |                    |     | 25 100              |                    |     | V/mV                         |
|  |  |  | Full range           | 15                  |                    |     | 15                  |                    |     |                              |
| CMRR Common-mode rejection ratio   | $V_{IC} = V_{ICRmin}$  |  | 25°C                 | 50 80               |                    |     | 60 80               |                    |     | dB                           |
| $k_{SVR}$ Supply-voltage rejection ratio ( $\Delta V_{CC}/\Delta V_{IO}$ ) |  |  | 25°C                 | 50 100              |                    |     | 60 100              |                    |     | dB                           |
| $V_{O1}/V_{O2}$ Crosstalk attenuation                                      | $f = 1\text{ kHz to }20\text{ kHz}$  |  | 25°C                 | 120                 |                    |     | 120                 |                    |     | dB                           |
| $I_O$ Output current   | $V_{CC} = 15\text{ V,}$<br>$V_{ID} = 1\text{ V,}$<br>$V_O = 0$                               | Source   | 25°C                 | -20 -30 -60         |                    |     | -20 -30 -60         |                    |     | mA                           |
|  |  |  | Full range           | -10                 |                    |     | -10                 |                    |     |                              |
|  | $V_{CC} = 15\text{ V,}$<br>$V_{ID} = -1\text{ V,}$<br>$V_O = 15\text{ V}$                    | Sink   | 25°C                 | 10 20               |                    |     | 10 20               |                    |     |                              |
|  |  |  | Full range           | 5                   |                    |     | 5                   |                    |     |                              |
|  | $V_{ID} = -1\text{ V, }V_O = 200\text{ mV}$  |  | 25°C                 | 30                  |                    |     | 12 40               |                    |     | $\mu\text{A}$                |
| $I_{OS}$ Short-circuit output current                                      | $V_{CC}$ at 5 V, $V_O = 0$ , GND at -5 V   |  | 25°C                 | $\pm 40 \pm 60$     |                    |     | $\pm 40 \pm 60$     |                    |     | mA                           |
| $I_{CC}$ Supply current (four amplifiers)                                  | $V_O = 2.5\text{ V, no load}$<br>$V_{CC} = \text{MAX, }V_O = 0.5\text{ }V_{CC,}$<br>no load  |  | Full range           | 0.7 1.2             |                    |     | 0.7 1.2             |                    |     | mA                           |
|  |  |  | Full range           | 1.4 3               |                    |     | 1.4 3               |                    |     |                              |

- All characteristics are measured under open-loop conditions, with zero common-mode input voltage, unless otherwise specified. MAX  $V_{CC}$  for testing purposes is 26 V for LM2902 and 32 V for LM2902V.
- Full range is  $-40^\circ\text{C}$  to  $125^\circ\text{C}$  for LM2902.
- All typical values are at  $T_A = 25^\circ\text{C}$ .

## 6.7 Electrical Characteristics for LMx24A and LM324KA

at specified free-air temperature,  $V_{CC} = 5\text{ V}$  (unless otherwise noted)

| PARAMETER                     | TEST CONDITIONS <sup>(1)</sup>  | $T_A$ <sup>(2)</sup> | LM124A |                    |     | LM224A  |                    |     | LM324A, LM324KA |                    |     | UNIT |
|-------------------------------|---|----------------------|--------|--------------------|-----|---------|--------------------|-----|-----------------|--------------------|-----|------|
|                               |   |                      | MIN    | TYP <sup>(3)</sup> | MAX | MIN     | TYP <sup>(3)</sup> | MAX | MIN             | TYP <sup>(3)</sup> | MAX |      |
| $V_{IO}$ Input offset voltage | $V_{CC} = 5\text{ V to }30\text{ V,}$<br>$V_{IC} = V_{ICRmin},$<br>$V_O = 1.4\text{ V}$ | 25°C                 | 2      |                    |     | 2 3     |                    |     | 2 3             |                    |     | mV   |
|                               |   | Full range           | 4      |                    |     | 4       |                    |     | 5               |                    |     |      |
| $I_{IO}$ Input offset current | $V_O = 1.4\text{ V}$  | 25°C                 | 10     |                    |     | 2 15    |                    |     | 2 30            |                    |     | nA   |
|                               |   | Full range           | 30     |                    |     | 30      |                    |     | 75              |                    |     |      |
| $I_{IB}$ Input bias current   | $V_O = 1.4\text{ V}$  | 25°C                 | -50    |                    |     | -15 -80 |                    |     | -15 -100        |                    |     | nA   |
|                               |   | Full range           | -100   |                    |     | -100    |                    |     | -200            |                    |     |      |

- All characteristics are measured under open-loop conditions, with zero common-mode input voltage, unless otherwise specified.
- Full range is  $-55^\circ\text{C}$  to  $125^\circ\text{C}$  for LM124A,  $-25^\circ\text{C}$  to  $85^\circ\text{C}$  for LM224A, and  $0^\circ\text{C}$  to  $70^\circ\text{C}$  for LM324A.
- All typical values are at  $T_A = 25^\circ\text{C}$ .

## Electrical Characteristics for LMx24A and LM324KA (continued)

at specified free-air temperature,  $V_{CC} = 5\text{ V}$  (unless otherwise noted)

| PARAMETER  | TEST CONDITIONS <sup>(1)</sup>  | $T_A$ <sup>(2)</sup> | LM124A                       |                    |     | LM224A              |                    |     | LM324A, LM324KA     |                    |     | UNIT          |       |
|--|---|----------------------|------------------------------|--------------------|-----|---------------------|--------------------|-----|---------------------|--------------------|-----|---------------|-------|
|  |   |                      | MIN                          | TYP <sup>(3)</sup> | MAX | MIN                 | TYP <sup>(3)</sup> | MAX | MIN                 | TYP <sup>(3)</sup> | MAX |               |       |
| $V_{ICR}$ Common-mode input voltage range                                  | $V_{CC} = 30\text{ V}$  | 25°C                 | 0 to $V_{CC} - 1.5$          |                    |     | 0 to $V_{CC} - 1.5$ |                    |     | 0 to $V_{CC} - 1.5$ |                    |     | V             |       |
|  |   | Full range           | 0 to $V_{CC} - 2$            |                    |     | 0 to $V_{CC} - 2$   |                    |     | 0 to $V_{CC} - 2$   |                    |     |               |       |
| $V_{OH}$ High-level output voltage   | $R_L = 2\text{ k}\Omega$<br>$V_{CC} = 30\text{ V}$  | 25°C                 | $V_{CC} - 1.5$               |                    |     | $V_{CC} - 1.5$      |                    |     | $V_{CC} - 1.5$      |                    |     | V             |       |
|  |   | Full range           | 26                           |                    |     | 26                  |                    |     | 26                  |                    |     |               |       |
|  |   |                      | $R_L \geq 10\text{ k}\Omega$ |                    |     | 27                  |                    |     | 27 28               |                    |     |               | 27 28 |
| $V_{OL}$ Low-level output voltage  | $R_L \leq 10\text{ k}\Omega$  | Full range           | 20                           |                    |     | 5 20                |                    |     | 5 20                |                    |     | mV            |       |
| $A_{VD}$ Large-signal differential voltage amplification                   | $V_{CC} = 15\text{ V}$ ,<br>$V_O = 1\text{ V to } 11\text{ V}$ ,<br>$R_L \geq 2\text{ k}\Omega$ | 25°C                 | 50 100                       |                    |     | 50 100              |                    |     | 25 100              |                    |     | V/mV          |       |
|  |   | Full range           | 25                           |                    |     | 25                  |                    |     | 15                  |                    |     |               |       |
| CMRR Common-mode rejection ratio   | $V_{IC} = V_{ICRmin}$   | 25°C                 | 70                           |                    |     | 70 80               |                    |     | 65 80               |                    |     | dB            |       |
| $k_{SVR}$ Supply-voltage rejection ratio ( $\Delta V_{CC}/\Delta V_{IO}$ ) |   | 25°C                 | 65                           |                    |     | 65 100              |                    |     | 65 100              |                    |     | dB            |       |
| $V_{O1}/V_{O2}$ Crosstalk attenuation                                      | $f = 1\text{ kHz to } 20\text{ kHz}$  | 25°C                 | 120                          |                    |     | 120                 |                    |     | 120                 |                    |     | dB            |       |
| $I_O$ Output current   | $V_{CC} = 15\text{ V}$ ,<br>$V_{ID} = 1\text{ V}$ ,<br>$V_O = 0$                                | Source               | 25°C                         | -20                |     |                     | -20 -30 -60        |     |                     | -20 -30 -60        |     |               | mA    |
|  |   |                      | Full range                   | -10                |     |                     | -10                |     |                     | -10                |     |               |       |
|  | $V_{CC} = 15\text{ V}$ ,<br>$V_{ID} = -1\text{ V}$ ,<br>$V_O = 15\text{ V}$                     | Sink                 | 25°C                         | 10                 |     |                     | 10 20              |     |                     | 1 20               |     |               |       |
|  |   |                      | Full range                   | 5                  |     |                     | 5                  |     |                     | 5                  |     |               |       |
|  | $V_{ID} = -1\text{ V}$ , $V_O = 200\text{ mV}$  | 25°C                 | 12                           |                    |     | 12 30               |                    |     | 12 30               |                    |     | $\mu\text{A}$ |       |
| $I_{OS}$ Short-circuit output current                                      | $V_{CC}$ at 5 V, GND at -5 V,<br>$V_O = 0$  | 25°C                 | $\pm 40$ $\pm 60$            |                    |     | $\pm 40$ $\pm 60$   |                    |     | $\pm 40$ $\pm 60$   |                    |     | mA            |       |
| $I_{CC}$ Supply current (four amplifiers)                                  | $V_O = 2.5\text{ V}$ , no load  | Full range           | 0.7 1.2                      |                    |     | 0.7 1.2             |                    |     | 0.7 1.2             |                    |     | mA            |       |
|  | $V_{CC} = 30\text{ V}$ , $V_O = 15\text{ V}$ , no load  | Full range           | 1.4 3.                       |                    |     | 1.4 3               |                    |     | 1.4 3               |                    |     |               |       |

## 6.8 Operating Conditions

 $V_{CC} = \pm 15\text{ V}$ ,  $T_A = 25^\circ\text{C}$ 

| PARAMETER                            | TEST CONDITIONS  | TYP | UNIT                   |
|--------------------------------------|--|-----|------------------------|
| SR Slew rate at unity gain           | $R_L = 1\text{ M}\Omega$ , $C_L = 30\text{ pF}$ , $V_I = \pm 10\text{ V}$ (see Figure 7) | 0.5 | V/ $\mu\text{s}$       |
| $B_1$ Unity-gain bandwidth           | $R_L = 1\text{ M}\Omega$ , $C_L = 20\text{ pF}$ (see Figure 7)                           | 1.2 | MHz                    |
| $V_n$ Equivalent input noise voltage | $R_S = 100\ \Omega$ , $V_I = 0\text{ V}$ , $f = 1\text{ kHz}$ (see Figure 8)             | 35  | nV/ $\sqrt{\text{Hz}}$ |

## 6.9 Typical Characteristics

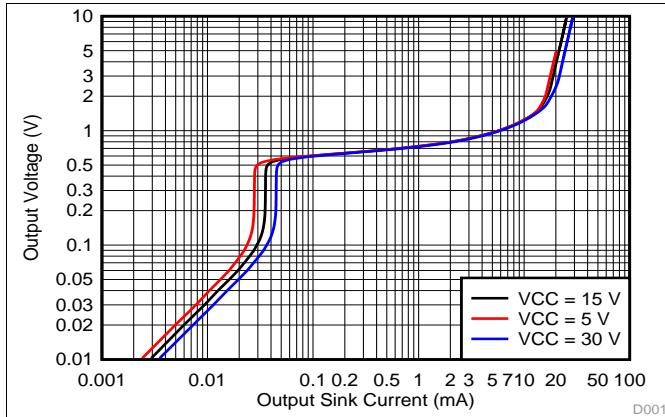

Figure 1. Output Sinking Characteristics



Figure 2. Output Sourcing Characteristics

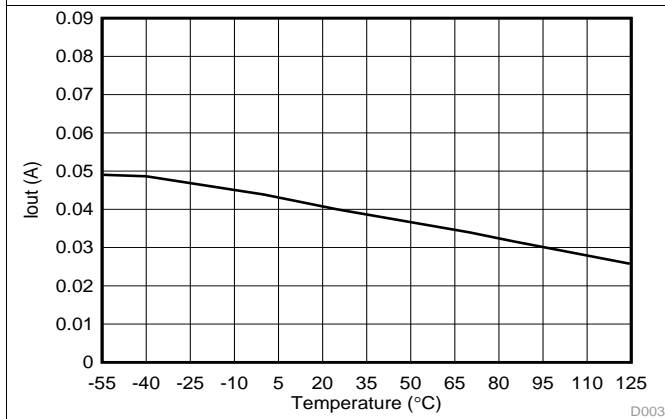

Figure 3. Source Current Limiting

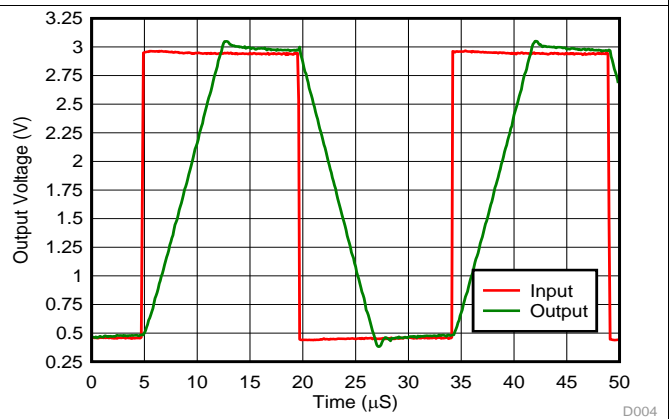

Figure 4. Voltage Follower Large Signal Response (50 pF)

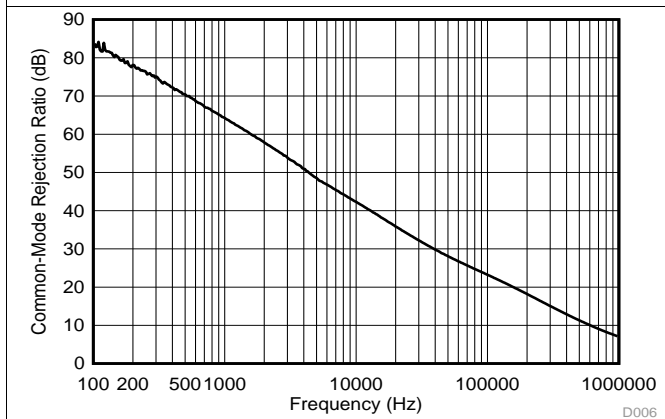

Figure 5. Common-Mode Rejection Ratio

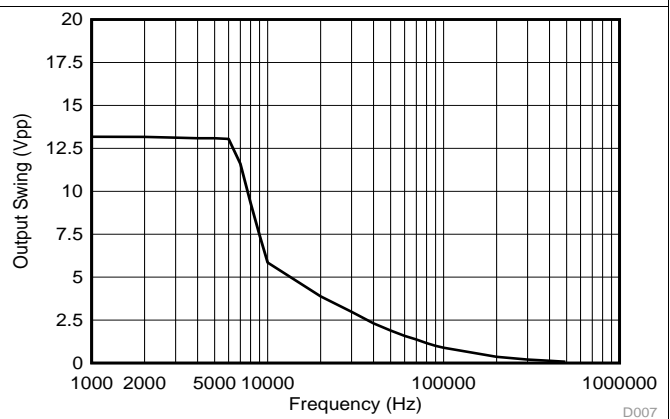

Figure 6. Maximum Output Swing vs. Frequency  
(VCC = 15 V)

## 7 Parameter Measurement Information



Figure 7. Unity-Gain Amplifier



Figure 8. Noise-Test Circuit

## 8 Detailed Description

### 8.1 Overview

These devices consist of four independent high-gain frequency-compensated operational amplifiers that are designed specifically to operate from a single supply over a wide range of voltages. Operation from split supplies also is possible if the difference between the two supplies is 3 V to 32 V (3 V to 26 V for the LM2902 device), and  $V_{CC}$  is at least 1.5 V more positive than the input common-mode voltage. The low supply-current drain is independent of the magnitude of the supply voltage.

Applications include transducer amplifiers, DC amplification blocks, and all the conventional operational-amplifier circuits that now can be more easily implemented in single-supply-voltage systems. For example, the LM124 device can be operated directly from the standard 5-V supply that is used in digital systems and provides the required interface electronics, without requiring additional  $\pm 15$ -V supplies.

### 8.2 Functional Block Diagram



| COMPONENT COUNT<br>(total device) |    |
|-----------------------------------|----|
| Epi-FET                           | 1  |
| Transistors                       | 95 |
| Diodes                            | 4  |
| Resistors                         | 11 |
| Capacitors                        | 4  |

† ESD protection cells - available on LM324K and LM324KA only

## 8.3 Feature Description

### 8.3.1 Unity-Gain Bandwidth

Gain bandwidth product is found by multiplying the measured bandwidth of an amplifier by the gain at which that bandwidth was measured. These devices have a high gain bandwidth of 1.2 MHz.

### 8.3.2 Slew Rate

The slew rate is the rate at which an operational amplifier can change its output when there is a change on the input. These devices have a 0.5-V/ $\mu$ s slew rate.

### 8.3.3 Input Common Mode Range

The valid common mode range is from device ground to  $V_{CC} - 1.5$  V ( $V_{CC} - 2$  V across temperature). Inputs may exceed  $V_{CC}$  up to the maximum  $V_{CC}$  without device damage. At least one input must be in the valid input common mode range for output to be correct phase. If both inputs exceed valid range then output phase is undefined. If either input is less than  $-0.3$  V then input current should be limited to 1 mA and output phase is undefined.

## 8.4 Device Functional Modes

These devices are powered on when the supply is connected. This device can be operated as a single supply operational amplifier or dual supply amplifier depending on the application.

## 9 Application and Implementation

### NOTE

Information in the following applications sections is not part of the TI component specification, and TI does not warrant its accuracy or completeness. TI's customers are responsible for determining suitability of components for their purposes. Customers should validate and test their design implementation to confirm system functionality.

### 9.1 Application Information

The LMx24 and LM2902 operational amplifiers are useful in a wide range of signal conditioning applications. Inputs can be powered before VCC for flexibility in multiple supply circuits.

### 9.2 Typical Application

A typical application for an operational amplifier in an inverting amplifier. This amplifier takes a positive voltage on the input, and makes it a negative voltage of the same magnitude. In the same manner, it also makes negative voltages positive.



Figure 9. Application Schematic

#### 9.2.1 Design Requirements

The supply voltage must be chosen such that it is larger than the input voltage range and output range. For instance, this application will scale a signal of  $\pm 0.5$  V to  $\pm 1.8$  V. Setting the supply at  $\pm 12$  V is sufficient to accommodate this application.

#### 9.2.2 Detailed Design Procedure

Determine the gain required by the inverting amplifier using [Equation 1](#) and [Equation 2](#):

$$A_v = \frac{V_{OUT}}{V_{IN}} \quad (1)$$

$$A_v = \frac{1.8}{-0.5} = -3.6 \quad (2)$$

Once the desired gain is determined, choose a value for  $R_I$  or  $R_F$ . Choosing a value in the kilohm range is desirable because the amplifier circuit will use currents in the milliamp range. This ensures the part will not draw too much current. This example will choose 10 k $\Omega$  for  $R_I$  which means 36 k $\Omega$  will be used for  $R_F$ . This was determined by [Equation 3](#).

$$A_v = -\frac{R_F}{R_I} \quad (3)$$

## Typical Application (continued)

### 9.2.3 Application Curve

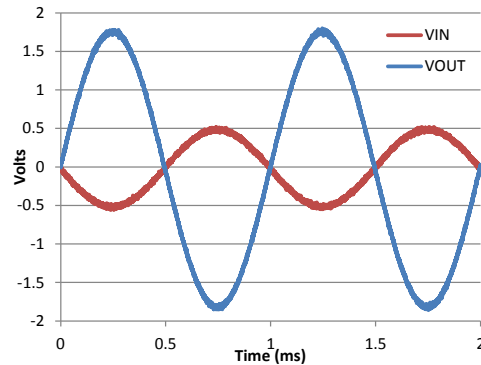

Figure 10. Input and Output Voltages of the Inverting Amplifier

## 10 Power Supply Recommendations

### CAUTION

Supply voltages larger than 32 V for a single supply, or outside the range of  $\pm 16$  V for a dual supply can permanently damage the device (see the [Absolute Maximum Ratings](#)).

Place 0.1- $\mu$ F bypass capacitors close to the power-supply pins to reduce errors coupling in from noisy or high impedance power supplies. For more detailed information on bypass capacitor placement, refer to the [Layout](#).

## 11 Layout

### 11.1 Layout Guidelines

For best operational performance of the device, use good PCB layout practices, including:

- Noise can propagate into analog circuitry through the power pins of the circuit as a whole, as well as the operational amplifier. Bypass capacitors are used to reduce the coupled noise by providing low impedance power sources local to the analog circuitry.
  - Connect low-ESR, 0.1- $\mu$ F ceramic bypass capacitors between each supply pin and ground, placed as close to the device as possible. A single bypass capacitor from V+ to ground is applicable for single supply applications.
- Separate grounding for analog and digital portions of circuitry is one of the simplest and most-effective methods of noise suppression. One or more layers on multilayer PCBs are usually devoted to ground planes. A ground plane helps distribute heat and reduces EMI noise pickup. Make sure to physically separate digital and analog grounds, paying attention to the flow of the ground current.
- To reduce parasitic coupling, run the input traces as far away from the supply or output traces as possible. If it is not possible to keep them separate, it is much better to cross the sensitive trace perpendicular as opposed to in parallel with the noisy trace.
- Place the external components as close to the device as possible. Keeping RF and RG close to the inverting input minimizes parasitic capacitance, as shown in [Layout Examples](#).
- Keep the length of input traces as short as possible. Always remember that the input traces are the most sensitive part of the circuit.
- Consider a driven, low-impedance guard ring around the critical traces. A guard ring can significantly reduce leakage currents from nearby traces that are at different potentials.

## 11.2 Layout Examples

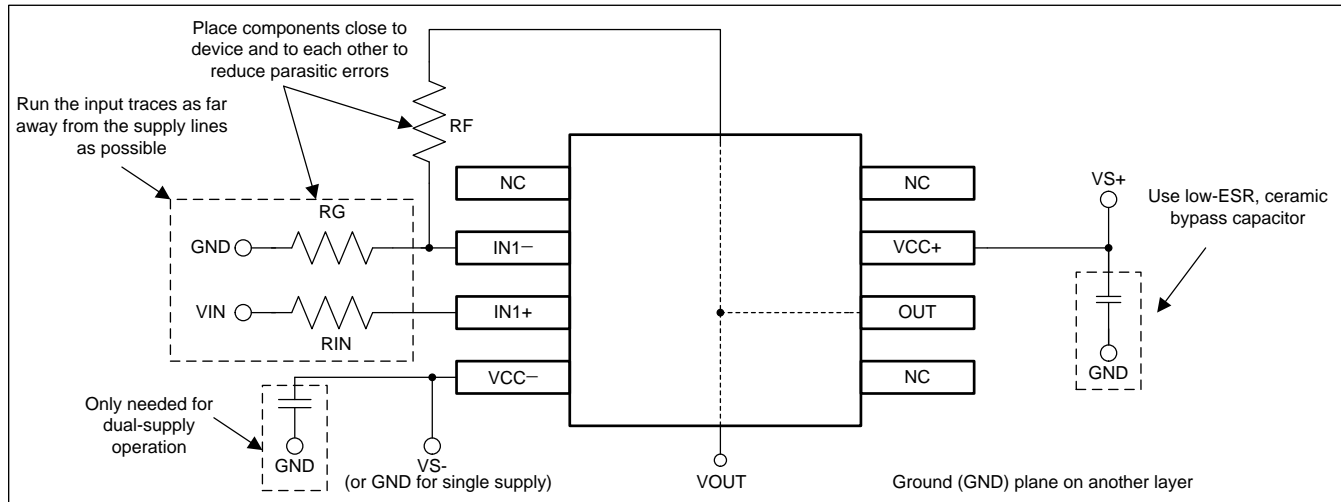

**Figure 11. Operational Amplifier Board Layout for Noninverting Configuration**

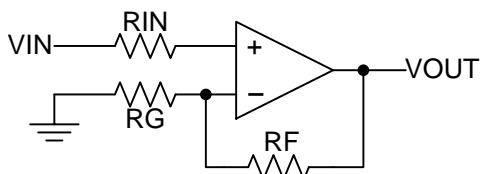

**Figure 12. Operational Amplifier Schematic for Noninverting Configuration**

## 12 Device and Documentation Support

### 12.1 Documentation Support

#### 12.1.1 Related Documentation

For related documentation, see the following:

- *Circuit Board Layout Techniques*, [SLOA089](#)

### 12.2 Related Links

The table below lists quick access links. Categories include technical documents, support and community resources, tools and software, and quick access to sample or buy.

**Table 1. Related Links**

| PARTS     | PRODUCT FOLDER             | SAMPLE & BUY               | TECHNICAL DOCUMENTS        | TOOLS & SOFTWARE           | SUPPORT & COMMUNITY        |
|-----------|----------------------------|----------------------------|----------------------------|----------------------------|----------------------------|
| LM124     | <a href="#">Click here</a> | <a href="#">Click here</a> | <a href="#">Click here</a> | <a href="#">Click here</a> | <a href="#">Click here</a> |
| LM124A    | <a href="#">Click here</a> | <a href="#">Click here</a> | <a href="#">Click here</a> | <a href="#">Click here</a> | <a href="#">Click here</a> |
| LM224     | <a href="#">Click here</a> | <a href="#">Click here</a> | <a href="#">Click here</a> | <a href="#">Click here</a> | <a href="#">Click here</a> |
| LM224A    | <a href="#">Click here</a> | <a href="#">Click here</a> | <a href="#">Click here</a> | <a href="#">Click here</a> | <a href="#">Click here</a> |
| LM324     | <a href="#">Click here</a> | <a href="#">Click here</a> | <a href="#">Click here</a> | <a href="#">Click here</a> | <a href="#">Click here</a> |
| LM324A    | <a href="#">Click here</a> | <a href="#">Click here</a> | <a href="#">Click here</a> | <a href="#">Click here</a> | <a href="#">Click here</a> |
| LM2902    | <a href="#">Click here</a> | <a href="#">Click here</a> | <a href="#">Click here</a> | <a href="#">Click here</a> | <a href="#">Click here</a> |
| LM2902V   | <a href="#">Click here</a> | <a href="#">Click here</a> | <a href="#">Click here</a> | <a href="#">Click here</a> | <a href="#">Click here</a> |
| LM224K    | <a href="#">Click here</a> | <a href="#">Click here</a> | <a href="#">Click here</a> | <a href="#">Click here</a> | <a href="#">Click here</a> |
| LM224KA   | <a href="#">Click here</a> | <a href="#">Click here</a> | <a href="#">Click here</a> | <a href="#">Click here</a> | <a href="#">Click here</a> |
| LM324K    | <a href="#">Click here</a> | <a href="#">Click here</a> | <a href="#">Click here</a> | <a href="#">Click here</a> | <a href="#">Click here</a> |
| LM324KA   | <a href="#">Click here</a> | <a href="#">Click here</a> | <a href="#">Click here</a> | <a href="#">Click here</a> | <a href="#">Click here</a> |
| LM2902K   | <a href="#">Click here</a> | <a href="#">Click here</a> | <a href="#">Click here</a> | <a href="#">Click here</a> | <a href="#">Click here</a> |
| LM2902KV  | <a href="#">Click here</a> | <a href="#">Click here</a> | <a href="#">Click here</a> | <a href="#">Click here</a> | <a href="#">Click here</a> |
| LM2902KAV | <a href="#">Click here</a> | <a href="#">Click here</a> | <a href="#">Click here</a> | <a href="#">Click here</a> | <a href="#">Click here</a> |

### 12.3 Trademarks

All trademarks are the property of their respective owners.

### 12.4 Electrostatic Discharge Caution



These devices have limited built-in ESD protection. The leads should be shorted together or the device placed in conductive foam during storage or handling to prevent electrostatic damage to the MOS gates.

### 12.5 Glossary

[SLYZ022](#) — *TI Glossary*.

This glossary lists and explains terms, acronyms and definitions.

## 13 Mechanical, Packaging, and Orderable Information

The following pages include mechanical packaging and orderable information. This information is the most current data available for the designated devices. This data is subject to change without notice and revision of this document. For browser based versions of this data sheet, refer to the left hand navigation.

**PACKAGING INFORMATION**

| Orderable Device | Status<br>(1) | Package Type | Package<br>Drawing | Pins | Package<br>Qty | Eco Plan<br>(2)            | Lead/Ball Finish<br>(6) | MSL Peak Temp<br>(3) | Op Temp (°C) | Device Marking<br>(4/5)            | Samples                 |
|------------------|---------------|--------------|--------------------|------|----------------|----------------------------|-------------------------|----------------------|--------------|------------------------------------|-------------------------|
| 5962-7704301VCA  | ACTIVE        | CDIP         | J                  | 14   | 1              | TBD                        | A42                     | N / A for Pkg Type   | -55 to 125   | 5962-7704301VC<br>A<br>LM124JQMLV  | <a href="#">Samples</a> |
| 5962-9950403V9B  | ACTIVE        | XCEPT        | KGD                | 0    | 100            | TBD                        | Call TI                 | N / A for Pkg Type   | -55 to 125   |                                    | <a href="#">Samples</a> |
| 5962-9950403VCA  | ACTIVE        | CDIP         | J                  | 14   | 1              | TBD                        | A42                     | N / A for Pkg Type   | -55 to 125   | 5962-9950403VC<br>A<br>LM124AJQMLV | <a href="#">Samples</a> |
| 77043012A        | ACTIVE        | LCCC         | FK                 | 20   | 1              | TBD                        | POST-PLATE              | N / A for Pkg Type   | -55 to 125   | 77043012A<br>LM124FKB              | <a href="#">Samples</a> |
| 7704301CA        | ACTIVE        | CDIP         | J                  | 14   | 1              | TBD                        | A42                     | N / A for Pkg Type   | -55 to 125   | 7704301CA<br>LM124JB               | <a href="#">Samples</a> |
| 7704301DA        | ACTIVE        | CFP          | W                  | 14   | 1              | TBD                        | A42                     | N / A for Pkg Type   | -55 to 125   | 7704301DA<br>LM124WB               | <a href="#">Samples</a> |
| 77043022A        | ACTIVE        | LCCC         | FK                 | 20   | 1              | TBD                        | POST-PLATE              | N / A for Pkg Type   | -55 to 125   | 77043022A<br>LM124AFKB             | <a href="#">Samples</a> |
| 7704302CA        | ACTIVE        | CDIP         | J                  | 14   | 1              | TBD                        | A42                     | N / A for Pkg Type   | -55 to 125   | 7704302CA<br>LM124AJB              | <a href="#">Samples</a> |
| 7704302DA        | ACTIVE        | CFP          | W                  | 14   | 1              | TBD                        | A42                     | N / A for Pkg Type   | -55 to 125   | 7704302DA<br>LM124AWB              | <a href="#">Samples</a> |
| JM38510/11005BCA | ACTIVE        | CDIP         | J                  | 14   | 1              | TBD                        | A42                     | N / A for Pkg Type   | -55 to 125   | JM38510<br>/11005BCA               | <a href="#">Samples</a> |
| LM124AFKB        | ACTIVE        | LCCC         | FK                 | 20   | 1              | TBD                        | POST-PLATE              | N / A for Pkg Type   | -55 to 125   | 77043022A<br>LM124AFKB             | <a href="#">Samples</a> |
| LM124AJ          | ACTIVE        | CDIP         | J                  | 14   | 1              | TBD                        | A42                     | N / A for Pkg Type   | -55 to 125   | LM124AJ                            | <a href="#">Samples</a> |
| LM124AJB         | ACTIVE        | CDIP         | J                  | 14   | 1              | TBD                        | A42                     | N / A for Pkg Type   | -55 to 125   | 7704302CA<br>LM124AJB              | <a href="#">Samples</a> |
| LM124AWB         | ACTIVE        | CFP          | W                  | 14   | 1              | TBD                        | A42                     | N / A for Pkg Type   | -55 to 125   | 7704302DA<br>LM124AWB              | <a href="#">Samples</a> |
| LM124D           | ACTIVE        | SOIC         | D                  | 14   | 50             | Green (RoHS<br>& no Sb/Br) | CU NIPDAU               | Level-1-260C-UNLIM   | -55 to 125   | LM124                              | <a href="#">Samples</a> |
| LM124DG4         | ACTIVE        | SOIC         | D                  | 14   | 50             | Green (RoHS<br>& no Sb/Br) | CU NIPDAU               | Level-1-260C-UNLIM   | -55 to 125   | LM124                              | <a href="#">Samples</a> |

| Orderable Device | Status<br>(1) | Package Type | Package Drawing | Pins | Package Qty | Eco Plan<br>(2)         | Lead/Ball Finish<br>(6) | MSL Peak Temp<br>(3) | Op Temp (°C) | Device Marking<br>(4/5) | Samples                 |
|------------------|---------------|--------------|-----------------|------|-------------|-------------------------|-------------------------|----------------------|--------------|-------------------------|-------------------------|
| LM124DR          | ACTIVE        | SOIC         | D               | 14   | 2500        | Green (RoHS & no Sb/Br) | CU NIPDAU               | Level-1-260C-UNLIM   | -55 to 125   | LM124                   | <a href="#">Samples</a> |
| LM124DRG4        | ACTIVE        | SOIC         | D               | 14   | 2500        | Green (RoHS & no Sb/Br) | CU NIPDAU               | Level-1-260C-UNLIM   | -55 to 125   | LM124                   | <a href="#">Samples</a> |
| LM124FKB         | ACTIVE        | LCCC         | FK              | 20   | 1           | TBD                     | POST-PLATE              | N / A for Pkg Type   | -55 to 125   | 77043012A<br>LM124FKB   | <a href="#">Samples</a> |
| LM124J           | ACTIVE        | CDIP         | J               | 14   | 1           | TBD                     | A42                     | N / A for Pkg Type   | -55 to 125   | LM124J                  | <a href="#">Samples</a> |
| LM124JB          | ACTIVE        | CDIP         | J               | 14   | 1           | TBD                     | A42                     | N / A for Pkg Type   | -55 to 125   | 7704301CA<br>LM124JB    | <a href="#">Samples</a> |
| LM124W           | ACTIVE        | CFP          | W               | 14   | 1           | TBD                     | A42                     | N / A for Pkg Type   | -55 to 125   | LM124W                  | <a href="#">Samples</a> |
| LM124WB          | ACTIVE        | CFP          | W               | 14   | 1           | TBD                     | A42                     | N / A for Pkg Type   | -55 to 125   | 7704301DA<br>LM124WB    | <a href="#">Samples</a> |
| LM224AD          | ACTIVE        | SOIC         | D               | 14   | 50          | Green (RoHS & no Sb/Br) | CU NIPDAU               | Level-1-260C-UNLIM   | -25 to 85    | LM224A                  | <a href="#">Samples</a> |
| LM224ADR         | ACTIVE        | SOIC         | D               | 14   | 2500        | Green (RoHS & no Sb/Br) | CU NIPDAU   CU SN       | Level-1-260C-UNLIM   | -25 to 85    | LM224A                  | <a href="#">Samples</a> |
| LM224ADRE4       | ACTIVE        | SOIC         | D               | 14   | 2500        | Green (RoHS & no Sb/Br) | CU NIPDAU               | Level-1-260C-UNLIM   | -25 to 85    | LM224A                  | <a href="#">Samples</a> |
| LM224ADRG4       | ACTIVE        | SOIC         | D               | 14   | 2500        | Green (RoHS & no Sb/Br) | CU NIPDAU               | Level-1-260C-UNLIM   | -25 to 85    | LM224A                  | <a href="#">Samples</a> |
| LM224AN          | ACTIVE        | PDIP         | N               | 14   | 25          | Green (RoHS & no Sb/Br) | CU NIPDAU               | N / A for Pkg Type   | -25 to 85    | LM224AN                 | <a href="#">Samples</a> |
| LM224D           | ACTIVE        | SOIC         | D               | 14   | 50          | Green (RoHS & no Sb/Br) | CU NIPDAU               | Level-1-260C-UNLIM   | -25 to 85    | LM224                   | <a href="#">Samples</a> |
| LM224DG4         | ACTIVE        | SOIC         | D               | 14   | 50          | Green (RoHS & no Sb/Br) | CU NIPDAU               | Level-1-260C-UNLIM   | -25 to 85    | LM224                   | <a href="#">Samples</a> |
| LM224DR          | ACTIVE        | SOIC         | D               | 14   | 2500        | Green (RoHS & no Sb/Br) | CU NIPDAU   CU SN       | Level-1-260C-UNLIM   | -25 to 85    | LM224                   | <a href="#">Samples</a> |
| LM224DRG3        | ACTIVE        | SOIC         | D               | 14   | 2500        | Green (RoHS & no Sb/Br) | CU SN                   | Level-1-260C-UNLIM   | -25 to 85    | LM224                   | <a href="#">Samples</a> |
| LM224DRG4        | ACTIVE        | SOIC         | D               | 14   | 2500        | Green (RoHS & no Sb/Br) | CU NIPDAU               | Level-1-260C-UNLIM   | -25 to 85    | LM224                   | <a href="#">Samples</a> |
| LM224KAD         | ACTIVE        | SOIC         | D               | 14   | 50          | Green (RoHS & no Sb/Br) | CU NIPDAU               | Level-1-260C-UNLIM   | -25 to 85    | LM224KA                 | <a href="#">Samples</a> |

| Orderable Device | Status<br>(1) | Package Type | Package Drawing | Pins | Package Qty | Eco Plan<br>(2)         | Lead/Ball Finish<br>(6) | MSL Peak Temp<br>(3) | Op Temp (°C) | Device Marking<br>(4/5) | Samples                 |
|------------------|---------------|--------------|-----------------|------|-------------|-------------------------|-------------------------|----------------------|--------------|-------------------------|-------------------------|
| LM224KADG4       | ACTIVE        | SOIC         | D               | 14   | 50          | Green (RoHS & no Sb/Br) | CU NIPDAU               | Level-1-260C-UNLIM   | -25 to 85    | LM224KA                 | <a href="#">Samples</a> |
| LM224KADR        | ACTIVE        | SOIC         | D               | 14   | 2500        | Green (RoHS & no Sb/Br) | CU NIPDAU               | Level-1-260C-UNLIM   | -25 to 85    | LM224KA                 | <a href="#">Samples</a> |
| LM224KADRG4      | ACTIVE        | SOIC         | D               | 14   | 2500        | Green (RoHS & no Sb/Br) | CU NIPDAU               | Level-1-260C-UNLIM   | -25 to 85    | LM224KA                 | <a href="#">Samples</a> |
| LM224KAN         | ACTIVE        | PDIP         | N               | 14   | 25          | Green (RoHS & no Sb/Br) | CU NIPDAU               | N / A for Pkg Type   | -25 to 85    | LM224KAN                | <a href="#">Samples</a> |
| LM224KDR         | ACTIVE        | SOIC         | D               | 14   | 2500        | Green (RoHS & no Sb/Br) | CU NIPDAU               | Level-1-260C-UNLIM   | -25 to 85    | LM224K                  | <a href="#">Samples</a> |
| LM224KDRG4       | ACTIVE        | SOIC         | D               | 14   | 2500        | Green (RoHS & no Sb/Br) | CU NIPDAU               | Level-1-260C-UNLIM   | -25 to 85    | LM224K                  | <a href="#">Samples</a> |
| LM224KN          | ACTIVE        | PDIP         | N               | 14   | 25          | Green (RoHS & no Sb/Br) | CU NIPDAU               | N / A for Pkg Type   | -25 to 85    | LM224KN                 | <a href="#">Samples</a> |
| LM224N           | ACTIVE        | PDIP         | N               | 14   | 25          | Green (RoHS & no Sb/Br) | CU NIPDAU               | N / A for Pkg Type   | -25 to 85    | LM224N                  | <a href="#">Samples</a> |
| LM224NE4         | ACTIVE        | PDIP         | N               | 14   | 25          | Green (RoHS & no Sb/Br) | CU NIPDAU               | N / A for Pkg Type   | -25 to 85    | LM224N                  | <a href="#">Samples</a> |
| LM2902D          | ACTIVE        | SOIC         | D               | 14   | 50          | Green (RoHS & no Sb/Br) | CU NIPDAU               | Level-1-260C-UNLIM   | -40 to 125   | LM2902                  | <a href="#">Samples</a> |
| LM2902DR         | ACTIVE        | SOIC         | D               | 14   | 2500        | Green (RoHS & no Sb/Br) | CU NIPDAU   CU SN       | Level-1-260C-UNLIM   | -40 to 125   | LM2902                  | <a href="#">Samples</a> |
| LM2902DRE4       | ACTIVE        | SOIC         | D               | 14   | 2500        | Green (RoHS & no Sb/Br) | CU NIPDAU               | Level-1-260C-UNLIM   | -40 to 125   | LM2902                  | <a href="#">Samples</a> |
| LM2902DRG3       | ACTIVE        | SOIC         | D               | 14   | 2500        | Green (RoHS & no Sb/Br) | CU SN                   | Level-1-260C-UNLIM   | -40 to 125   | LM2902                  | <a href="#">Samples</a> |
| LM2902DRG4       | ACTIVE        | SOIC         | D               | 14   | 2500        | Green (RoHS & no Sb/Br) | CU NIPDAU               | Level-1-260C-UNLIM   | -40 to 125   | LM2902                  | <a href="#">Samples</a> |
| LM2902KAVQDR     | ACTIVE        | SOIC         | D               | 14   | 2500        | Green (RoHS & no Sb/Br) | CU NIPDAU               | Level-1-260C-UNLIM   | -40 to 125   | L2902KA                 | <a href="#">Samples</a> |
| LM2902KAVQDRG4   | ACTIVE        | SOIC         | D               | 14   | 2500        | Green (RoHS & no Sb/Br) | CU NIPDAU               | Level-1-260C-UNLIM   | -40 to 125   | L2902KA                 | <a href="#">Samples</a> |
| LM2902KAVQPWR    | ACTIVE        | TSSOP        | PW              | 14   | 2000        | Green (RoHS & no Sb/Br) | CU NIPDAU               | Level-1-260C-UNLIM   | -40 to 125   | L2902KA                 | <a href="#">Samples</a> |
| LM2902KAVQPWRG4  | ACTIVE        | TSSOP        | PW              | 14   | 2000        | Green (RoHS & no Sb/Br) | CU NIPDAU               | Level-1-260C-UNLIM   | -40 to 125   | L2902KA                 | <a href="#">Samples</a> |

| Orderable Device | Status<br>(1) | Package Type | Package Drawing | Pins | Package Qty | Eco Plan<br>(2)         | Lead/Ball Finish<br>(6) | MSL Peak Temp<br>(3) | Op Temp (°C) | Device Marking<br>(4/5) | Samples                 |
|------------------|---------------|--------------|-----------------|------|-------------|-------------------------|-------------------------|----------------------|--------------|-------------------------|-------------------------|
| LM2902KD         | ACTIVE        | SOIC         | D               | 14   | 50          | Green (RoHS & no Sb/Br) | CU NIPDAU               | Level-1-260C-UNLIM   | -40 to 125   | LM2902K                 | <a href="#">Samples</a> |
| LM2902KDB        | ACTIVE        | SSOP         | DB              | 14   | 80          | Green (RoHS & no Sb/Br) | CU NIPDAU               | Level-1-260C-UNLIM   | -40 to 125   | L2902K                  | <a href="#">Samples</a> |
| LM2902KDG4       | ACTIVE        | SOIC         | D               | 14   | 50          | Green (RoHS & no Sb/Br) | CU NIPDAU               | Level-1-260C-UNLIM   | -40 to 125   | LM2902K                 | <a href="#">Samples</a> |
| LM2902KDR        | ACTIVE        | SOIC         | D               | 14   | 2500        | Green (RoHS & no Sb/Br) | CU NIPDAU               | Level-1-260C-UNLIM   | -40 to 125   | LM2902K                 | <a href="#">Samples</a> |
| LM2902KN         | ACTIVE        | PDIP         | N               | 14   | 25          | Green (RoHS & no Sb/Br) | CU NIPDAU               | N / A for Pkg Type   | -40 to 125   | LM2902KN                | <a href="#">Samples</a> |
| LM2902KNSR       | ACTIVE        | SO           | NS              | 14   | 2000        | Green (RoHS & no Sb/Br) | CU NIPDAU               | Level-1-260C-UNLIM   | -40 to 125   | LM2902K                 | <a href="#">Samples</a> |
| LM2902KNSRG4     | ACTIVE        | SO           | NS              | 14   | 2000        | Green (RoHS & no Sb/Br) | CU NIPDAU               | Level-1-260C-UNLIM   | -40 to 125   | LM2902K                 | <a href="#">Samples</a> |
| LM2902KPW        | ACTIVE        | TSSOP        | PW              | 14   | 90          | Green (RoHS & no Sb/Br) | CU NIPDAU               | Level-1-260C-UNLIM   | -40 to 125   | L2902K                  | <a href="#">Samples</a> |
| LM2902KPWE4      | ACTIVE        | TSSOP        | PW              | 14   | 90          | Green (RoHS & no Sb/Br) | CU NIPDAU               | Level-1-260C-UNLIM   | -40 to 125   | L2902K                  | <a href="#">Samples</a> |
| LM2902KPWR       | ACTIVE        | TSSOP        | PW              | 14   | 2000        | Green (RoHS & no Sb/Br) | CU NIPDAU               | Level-1-260C-UNLIM   | -40 to 125   | L2902K                  | <a href="#">Samples</a> |
| LM2902KVQDR      | ACTIVE        | SOIC         | D               | 14   | 2500        | Green (RoHS & no Sb/Br) | CU NIPDAU               | Level-1-260C-UNLIM   | -40 to 125   | L2902KV                 | <a href="#">Samples</a> |
| LM2902KVQDRG4    | ACTIVE        | SOIC         | D               | 14   | 2500        | Green (RoHS & no Sb/Br) | CU NIPDAU               | Level-1-260C-UNLIM   | -40 to 125   | L2902KV                 | <a href="#">Samples</a> |
| LM2902KVQPWR     | ACTIVE        | TSSOP        | PW              | 14   | 2000        | Green (RoHS & no Sb/Br) | CU NIPDAU               | Level-1-260C-UNLIM   | -40 to 125   | L2902KV                 | <a href="#">Samples</a> |
| LM2902KVQPWRG4   | ACTIVE        | TSSOP        | PW              | 14   | 2000        | Green (RoHS & no Sb/Br) | CU NIPDAU               | Level-1-260C-UNLIM   | -40 to 125   | L2902KV                 | <a href="#">Samples</a> |
| LM2902N          | ACTIVE        | PDIP         | N               | 14   | 25          | Green (RoHS & no Sb/Br) | CU NIPDAU   CU SN       | N / A for Pkg Type   | -40 to 125   | LM2902N                 | <a href="#">Samples</a> |
| LM2902NE4        | ACTIVE        | PDIP         | N               | 14   | 25          | Pb-Free (RoHS)          | CU NIPDAU               | N / A for Pkg Type   | -40 to 125   | LM2902N                 | <a href="#">Samples</a> |
| LM2902NSR        | ACTIVE        | SO           | NS              | 14   | 2000        | Green (RoHS & no Sb/Br) | CU NIPDAU               | Level-1-260C-UNLIM   | -40 to 125   | LM2902                  | <a href="#">Samples</a> |
| LM2902PW         | ACTIVE        | TSSOP        | PW              | 14   | 90          | Green (RoHS & no Sb/Br) | CU NIPDAU               | Level-1-260C-UNLIM   | -40 to 125   | L2902                   | <a href="#">Samples</a> |

| Orderable Device | Status<br>(1) | Package Type | Package Drawing | Pins | Package Qty | Eco Plan<br>(2)         | Lead/Ball Finish<br>(6) | MSL Peak Temp<br>(3) | Op Temp (°C) | Device Marking<br>(4/5) | Samples                 |
|------------------|---------------|--------------|-----------------|------|-------------|-------------------------|-------------------------|----------------------|--------------|-------------------------|-------------------------|
| LM2902PWR        | ACTIVE        | TSSOP        | PW              | 14   | 2000        | Green (RoHS & no Sb/Br) | CU NIPDAU   CU SN       | Level-1-260C-UNLIM   | -40 to 125   | L2902                   | <a href="#">Samples</a> |
| LM2902PWRE4      | ACTIVE        | TSSOP        | PW              | 14   | 2000        | Green (RoHS & no Sb/Br) | CU NIPDAU               | Level-1-260C-UNLIM   | -40 to 125   | L2902                   | <a href="#">Samples</a> |
| LM2902PWRG3      | ACTIVE        | TSSOP        | PW              | 14   | 2000        | Green (RoHS & no Sb/Br) | CU SN                   | Level-1-260C-UNLIM   | -40 to 125   | L2902                   | <a href="#">Samples</a> |
| LM2902PWRG4      | ACTIVE        | TSSOP        | PW              | 14   | 2000        | Green (RoHS & no Sb/Br) | CU NIPDAU               | Level-1-260C-UNLIM   | -40 to 125   | L2902                   | <a href="#">Samples</a> |
| LM324AD          | ACTIVE        | SOIC         | D               | 14   | 50          | Green (RoHS & no Sb/Br) | CU NIPDAU               | Level-1-260C-UNLIM   | 0 to 70      | LM324A                  | <a href="#">Samples</a> |
| LM324ADB         | ACTIVE        | SSOP         | DB              | 14   | 2000        | Green (RoHS & no Sb/Br) | CU NIPDAU               | Level-1-260C-UNLIM   | 0 to 70      | LM324A                  | <a href="#">Samples</a> |
| LM324ADE4        | ACTIVE        | SOIC         | D               | 14   | 50          | Green (RoHS & no Sb/Br) | CU NIPDAU               | Level-1-260C-UNLIM   | 0 to 70      | LM324A                  | <a href="#">Samples</a> |
| LM324ADR         | ACTIVE        | SOIC         | D               | 14   | 2500        | Green (RoHS & no Sb/Br) | CU NIPDAU   CU SN       | Level-1-260C-UNLIM   | 0 to 70      | LM324A                  | <a href="#">Samples</a> |
| LM324ADRE4       | ACTIVE        | SOIC         | D               | 14   | 2500        | Green (RoHS & no Sb/Br) | CU NIPDAU               | Level-1-260C-UNLIM   | 0 to 70      | LM324A                  | <a href="#">Samples</a> |
| LM324ADRG4       | ACTIVE        | SOIC         | D               | 14   | 2500        | Green (RoHS & no Sb/Br) | CU NIPDAU               | Level-1-260C-UNLIM   | 0 to 70      | LM324A                  | <a href="#">Samples</a> |
| LM324AN          | ACTIVE        | PDIP         | N               | 14   | 25          | Green (RoHS & no Sb/Br) | CU NIPDAU               | N / A for Pkg Type   | 0 to 70      | LM324AN                 | <a href="#">Samples</a> |
| LM324ANSR        | ACTIVE        | SO           | NS              | 14   | 2000        | Green (RoHS & no Sb/Br) | CU NIPDAU               | Level-1-260C-UNLIM   | 0 to 70      | LM324A                  | <a href="#">Samples</a> |
| LM324ANSRG4      | ACTIVE        | SO           | NS              | 14   | 2000        | Green (RoHS & no Sb/Br) | CU NIPDAU               | Level-1-260C-UNLIM   | 0 to 70      | LM324A                  | <a href="#">Samples</a> |
| LM324APW         | ACTIVE        | TSSOP        | PW              | 14   | 90          | Green (RoHS & no Sb/Br) | CU NIPDAU               | Level-1-260C-UNLIM   | 0 to 70      | L324A                   | <a href="#">Samples</a> |
| LM324APWE4       | ACTIVE        | TSSOP        | PW              | 14   | 90          | Green (RoHS & no Sb/Br) | CU NIPDAU               | Level-1-260C-UNLIM   | 0 to 70      | L324A                   | <a href="#">Samples</a> |
| LM324APWR        | ACTIVE        | TSSOP        | PW              | 14   | 2000        | Green (RoHS & no Sb/Br) | CU NIPDAU   CU SN       | Level-1-260C-UNLIM   | 0 to 70      | L324A                   | <a href="#">Samples</a> |
| LM324APWRG4      | ACTIVE        | TSSOP        | PW              | 14   | 2000        | Green (RoHS & no Sb/Br) | CU NIPDAU               | Level-1-260C-UNLIM   | 0 to 70      | L324A                   | <a href="#">Samples</a> |
| LM324D           | ACTIVE        | SOIC         | D               | 14   | 50          | Green (RoHS & no Sb/Br) | CU NIPDAU               | Level-1-260C-UNLIM   | 0 to 70      | LM324                   | <a href="#">Samples</a> |

| Orderable Device | Status<br>(1) | Package Type | Package Drawing | Pins | Package Qty | Eco Plan<br>(2)         | Lead/Ball Finish<br>(6) | MSL Peak Temp<br>(3) | Op Temp (°C) | Device Marking<br>(4/5) | Samples                 |
|------------------|---------------|--------------|-----------------|------|-------------|-------------------------|-------------------------|----------------------|--------------|-------------------------|-------------------------|
| LM324DE4         | ACTIVE        | SOIC         | D               | 14   | 50          | Green (RoHS & no Sb/Br) | CU NIPDAU               | Level-1-260C-UNLIM   | 0 to 70      | LM324                   | <a href="#">Samples</a> |
| LM324DG4         | ACTIVE        | SOIC         | D               | 14   | 50          | Green (RoHS & no Sb/Br) | CU NIPDAU               | Level-1-260C-UNLIM   | 0 to 70      | LM324                   | <a href="#">Samples</a> |
| LM324DR          | ACTIVE        | SOIC         | D               | 14   | 2500        | Green (RoHS & no Sb/Br) | CU NIPDAU   CU SN       | Level-1-260C-UNLIM   | 0 to 70      | LM324                   | <a href="#">Samples</a> |
| LM324DRE4        | ACTIVE        | SOIC         | D               | 14   | 2500        | Green (RoHS & no Sb/Br) | CU NIPDAU               | Level-1-260C-UNLIM   | 0 to 70      | LM324                   | <a href="#">Samples</a> |
| LM324DRG3        | ACTIVE        | SOIC         | D               | 14   | 2500        | Green (RoHS & no Sb/Br) | CU SN                   | Level-1-260C-UNLIM   | 0 to 70      | LM324                   | <a href="#">Samples</a> |
| LM324DRG4        | ACTIVE        | SOIC         | D               | 14   | 2500        | Green (RoHS & no Sb/Br) | CU NIPDAU               | Level-1-260C-UNLIM   | 0 to 70      | LM324                   | <a href="#">Samples</a> |
| LM324KAD         | ACTIVE        | SOIC         | D               | 14   | 50          | Green (RoHS & no Sb/Br) | CU NIPDAU               | Level-1-260C-UNLIM   | 0 to 70      | LM324KA                 | <a href="#">Samples</a> |
| LM324KADR        | ACTIVE        | SOIC         | D               | 14   | 2500        | Green (RoHS & no Sb/Br) | CU NIPDAU               | Level-1-260C-UNLIM   | 0 to 70      | LM324KA                 | <a href="#">Samples</a> |
| LM324KADRG4      | ACTIVE        | SOIC         | D               | 14   | 2500        | Green (RoHS & no Sb/Br) | CU NIPDAU               | Level-1-260C-UNLIM   | 0 to 70      | LM324KA                 | <a href="#">Samples</a> |
| LM324KAN         | ACTIVE        | PDIP         | N               | 14   | 25          | Green (RoHS & no Sb/Br) | CU NIPDAU               | N / A for Pkg Type   | 0 to 70      | LM324KAN                | <a href="#">Samples</a> |
| LM324KANSR       | ACTIVE        | SO           | NS              | 14   | 2000        | Green (RoHS & no Sb/Br) | CU NIPDAU               | Level-1-260C-UNLIM   | 0 to 70      | LM324KA                 | <a href="#">Samples</a> |
| LM324KAPW        | ACTIVE        | TSSOP        | PW              | 14   | 90          | Green (RoHS & no Sb/Br) | CU NIPDAU               | Level-1-260C-UNLIM   | 0 to 70      | L324KA                  | <a href="#">Samples</a> |
| LM324KAPWR       | ACTIVE        | TSSOP        | PW              | 14   | 2000        | Green (RoHS & no Sb/Br) | CU NIPDAU               | Level-1-260C-UNLIM   | 0 to 70      | L324KA                  | <a href="#">Samples</a> |
| LM324KAPWRG4     | ACTIVE        | TSSOP        | PW              | 14   | 2000        | Green (RoHS & no Sb/Br) | CU NIPDAU               | Level-1-260C-UNLIM   | 0 to 70      | L324KA                  | <a href="#">Samples</a> |
| LM324KDR         | ACTIVE        | SOIC         | D               | 14   | 2500        | Green (RoHS & no Sb/Br) | CU NIPDAU               | Level-1-260C-UNLIM   | 0 to 70      | LM324K                  | <a href="#">Samples</a> |
| LM324KN          | ACTIVE        | PDIP         | N               | 14   | 25          | Green (RoHS & no Sb/Br) | CU NIPDAU               | N / A for Pkg Type   | 0 to 70      | LM324KN                 | <a href="#">Samples</a> |
| LM324KNSR        | ACTIVE        | SO           | NS              | 14   | 2000        | Green (RoHS & no Sb/Br) | CU NIPDAU               | Level-1-260C-UNLIM   | 0 to 70      | LM324K                  | <a href="#">Samples</a> |
| LM324KPW         | ACTIVE        | TSSOP        | PW              | 14   | 90          | Green (RoHS & no Sb/Br) | CU NIPDAU               | Level-1-260C-UNLIM   | 0 to 70      | L324K                   | <a href="#">Samples</a> |

| Orderable Device | Status<br>(1) | Package Type | Package Drawing | Pins | Package Qty | Eco Plan<br>(2)         | Lead/Ball Finish<br>(6) | MSL Peak Temp<br>(3) | Op Temp (°C) | Device Marking<br>(4/5) | Samples                 |
|------------------|---------------|--------------|-----------------|------|-------------|-------------------------|-------------------------|----------------------|--------------|-------------------------|-------------------------|
| LM324KPWR        | ACTIVE        | TSSOP        | PW              | 14   | 2000        | Green (RoHS & no Sb/Br) | CU NIPDAU               | Level-1-260C-UNLIM   | 0 to 70      | L324K                   | <a href="#">Samples</a> |
| LM324N           | ACTIVE        | PDIP         | N               | 14   | 25          | Green (RoHS & no Sb/Br) | CU NIPDAU   CU SN       | N / A for Pkg Type   | 0 to 70      | LM324N                  | <a href="#">Samples</a> |
| LM324NE3         | ACTIVE        | PDIP         | N               | 14   | 25          | Pb-Free (RoHS)          | CU SN                   | N / A for Pkg Type   | 0 to 70      | LM324N                  | <a href="#">Samples</a> |
| LM324NE4         | ACTIVE        | PDIP         | N               | 14   | 25          | Green (RoHS & no Sb/Br) | CU NIPDAU               | N / A for Pkg Type   | 0 to 70      | LM324N                  | <a href="#">Samples</a> |
| LM324NSR         | ACTIVE        | SO           | NS              | 14   | 2000        | Green (RoHS & no Sb/Br) | CU NIPDAU               | Level-1-260C-UNLIM   | 0 to 70      | LM324                   | <a href="#">Samples</a> |
| LM324NSRE4       | ACTIVE        | SO           | NS              | 14   | 2000        | Green (RoHS & no Sb/Br) | CU NIPDAU               | Level-1-260C-UNLIM   | 0 to 70      | LM324                   | <a href="#">Samples</a> |
| LM324NSRG4       | ACTIVE        | SO           | NS              | 14   | 2000        | Green (RoHS & no Sb/Br) | CU NIPDAU               | Level-1-260C-UNLIM   | 0 to 70      | LM324                   | <a href="#">Samples</a> |
| LM324PW          | ACTIVE        | TSSOP        | PW              | 14   | 90          | Green (RoHS & no Sb/Br) | CU NIPDAU               | Level-1-260C-UNLIM   | 0 to 70      | L324                    | <a href="#">Samples</a> |
| LM324PWR         | ACTIVE        | TSSOP        | PW              | 14   | 2000        | Green (RoHS & no Sb/Br) | CU NIPDAU   CU SN       | Level-1-260C-UNLIM   | 0 to 70      | L324                    | <a href="#">Samples</a> |
| LM324PWRE4       | ACTIVE        | TSSOP        | PW              | 14   | 2000        | Green (RoHS & no Sb/Br) | CU NIPDAU               | Level-1-260C-UNLIM   | 0 to 70      | L324                    | <a href="#">Samples</a> |
| LM324PWRG3       | ACTIVE        | TSSOP        | PW              | 14   | 2000        | Green (RoHS & no Sb/Br) | CU SN                   | Level-1-260C-UNLIM   | 0 to 70      | L324                    | <a href="#">Samples</a> |
| LM324PWRG4       | ACTIVE        | TSSOP        | PW              | 14   | 2000        | Green (RoHS & no Sb/Br) | CU NIPDAU               | Level-1-260C-UNLIM   | 0 to 70      | L324                    | <a href="#">Samples</a> |
| M38510/11005BCA  | ACTIVE        | CDIP         | J               | 14   | 1           | TBD                     | A42                     | N / A for Pkg Type   | -55 to 125   | JM38510 /11005BCA       | <a href="#">Samples</a> |

(1) The marketing status values are defined as follows:

**ACTIVE:** Product device recommended for new designs.

**LIFEBUY:** TI has announced that the device will be discontinued, and a lifetime-buy period is in effect.

**NRND:** Not recommended for new designs. Device is in production to support existing customers, but TI does not recommend using this part in a new design.

**PREVIEW:** Device has been announced but is not in production. Samples may or may not be available.

**OBSOLETE:** TI has discontinued the production of the device.

(2) **RoHS:** TI defines "RoHS" to mean semiconductor products that are compliant with the current EU RoHS requirements for all 10 RoHS substances, including the requirement that RoHS substance do not exceed 0.1% by weight in homogeneous materials. Where designed to be soldered at high temperatures, "RoHS" products are suitable for use in specified lead-free processes. TI may reference these types of products as "Pb-Free".

---

**RoHS Exempt:** TI defines "RoHS Exempt" to mean products that contain lead but are compliant with EU RoHS pursuant to a specific EU RoHS exemption.

**Green:** TI defines "Green" to mean the content of Chlorine (Cl) and Bromine (Br) based flame retardants meet JS709B low halogen requirements of <=1000ppm threshold. Antimony trioxide based flame retardants must also meet the <=1000ppm threshold requirement.

(3) MSL, Peak Temp. - The Moisture Sensitivity Level rating according to the JEDEC industry standard classifications, and peak solder temperature.

(4) There may be additional marking, which relates to the logo, the lot trace code information, or the environmental category on the device.

(5) Multiple Device Markings will be inside parentheses. Only one Device Marking contained in parentheses and separated by a "~" will appear on a device. If a line is indented then it is a continuation of the previous line and the two combined represent the entire Device Marking for that device.

(6) Lead/Ball Finish - Orderable Devices may have multiple material finish options. Finish options are separated by a vertical ruled line. Lead/Ball Finish values may wrap to two lines if the finish value exceeds the maximum column width.

**Important Information and Disclaimer:** The information provided on this page represents TI's knowledge and belief as of the date that it is provided. TI bases its knowledge and belief on information provided by third parties, and makes no representation or warranty as to the accuracy of such information. Efforts are underway to better integrate information from third parties. TI has taken and continues to take reasonable steps to provide representative and accurate information but may not have conducted destructive testing or chemical analysis on incoming materials and chemicals. TI and TI suppliers consider certain information to be proprietary, and thus CAS numbers and other limited information may not be available for release.

In no event shall TI's liability arising out of such information exceed the total purchase price of the TI part(s) at issue in this document sold by TI to Customer on an annual basis.

**OTHER QUALIFIED VERSIONS OF LM124, LM124-SP, LM124M, LM2902 :**

- Catalog: [LM124](#), [LM124](#)
- Automotive: [LM2902-Q1](#)
- Enhanced Product: [LM2902-EP](#)
- Military: [LM124M](#), [LM124M](#)
- Space: [LM124-SP](#), [LM124-SP](#)

**NOTE: Qualified Version Definitions:**

- Catalog - TI's standard catalog product
- Automotive - Q100 devices qualified for high-reliability automotive applications targeting zero defects

- Enhanced Product - Supports Defense, Aerospace and Medical Applications
- Military - QML certified for Military and Defense Applications
- Space - Radiation tolerant, ceramic packaging and qualified for use in Space-based application

## TAPE AND REEL INFORMATION



### QUADRANT ASSIGNMENTS FOR PIN 1 ORIENTATION IN TAPE



\*All dimensions are nominal

| Device        | Package Type | Package Drawing | Pins | SPQ  | Reel Diameter (mm) | Reel Width W1 (mm) | A0 (mm) | B0 (mm) | K0 (mm) | P1 (mm) | W (mm) | Pin1 Quadrant |
|---------------|--------------|-----------------|------|------|--------------------|--------------------|---------|---------|---------|---------|--------|---------------|
| LM124DR       | SOIC         | D               | 14   | 2500 | 330.0              | 16.4               | 6.5     | 9.0     | 2.1     | 8.0     | 16.0   | Q1            |
| LM224ADR      | SOIC         | D               | 14   | 2500 | 330.0              | 16.4               | 6.5     | 9.0     | 2.1     | 8.0     | 16.0   | Q1            |
| LM224ADR      | SOIC         | D               | 14   | 2500 | 330.0              | 16.8               | 6.5     | 9.5     | 2.1     | 8.0     | 16.0   | Q1            |
| LM224ADR      | SOIC         | D               | 14   | 2500 | 330.0              | 16.4               | 6.5     | 9.0     | 2.1     | 8.0     | 16.0   | Q1            |
| LM224ADRG4    | SOIC         | D               | 14   | 2500 | 330.0              | 16.4               | 6.5     | 9.0     | 2.1     | 8.0     | 16.0   | Q1            |
| LM224ADRG4    | SOIC         | D               | 14   | 2500 | 330.0              | 16.4               | 6.5     | 9.0     | 2.1     | 8.0     | 16.0   | Q1            |
| LM224DR       | SOIC         | D               | 14   | 2500 | 330.0              | 17.0               | 6.4     | 9.05    | 2.1     | 8.0     | 16.0   | Q1            |
| LM224DR       | SOIC         | D               | 14   | 2500 | 330.0              | 16.4               | 6.5     | 9.0     | 2.1     | 8.0     | 16.0   | Q1            |
| LM224DRG3     | SOIC         | D               | 14   | 2500 | 330.0              | 16.8               | 6.5     | 9.5     | 2.1     | 8.0     | 16.0   | Q1            |
| LM224DRG3     | SOIC         | D               | 14   | 2500 | 330.0              | 17.0               | 6.4     | 9.05    | 2.1     | 8.0     | 16.0   | Q1            |
| LM224KADR     | SOIC         | D               | 14   | 2500 | 330.0              | 16.4               | 6.5     | 9.0     | 2.1     | 8.0     | 16.0   | Q1            |
| LM224KDR      | SOIC         | D               | 14   | 2500 | 330.0              | 16.4               | 6.5     | 9.0     | 2.1     | 8.0     | 16.0   | Q1            |
| LM2902DR      | SOIC         | D               | 14   | 2500 | 330.0              | 16.4               | 6.5     | 9.0     | 2.1     | 8.0     | 16.0   | Q1            |
| LM2902DR      | SOIC         | D               | 14   | 2500 | 330.0              | 17.0               | 6.4     | 9.05    | 2.1     | 8.0     | 16.0   | Q1            |
| LM2902DR      | SOIC         | D               | 14   | 2500 | 330.0              | 16.4               | 6.5     | 9.0     | 2.1     | 8.0     | 16.0   | Q1            |
| LM2902DRG3    | SOIC         | D               | 14   | 2500 | 330.0              | 16.8               | 6.5     | 9.5     | 2.1     | 8.0     | 16.0   | Q1            |
| LM2902DRG4    | SOIC         | D               | 14   | 2500 | 330.0              | 16.4               | 6.5     | 9.0     | 2.1     | 8.0     | 16.0   | Q1            |
| LM2902KAVQPWR | TSSOP        | PW              | 14   | 2000 | 330.0              | 12.4               | 6.9     | 5.6     | 1.6     | 8.0     | 12.0   | Q1            |

| Device          | Package Type | Package Drawing | Pins | SPQ  | Reel Diameter (mm) | Reel Width W1 (mm) | A0 (mm) | B0 (mm) | K0 (mm) | P1 (mm) | W (mm) | Pin1 Quadrant |
|-----------------|--------------|-----------------|------|------|--------------------|--------------------|---------|---------|---------|---------|--------|---------------|
| LM2902KAVQPWRG4 | TSSOP        | PW              | 14   | 2000 | 330.0              | 12.4               | 6.9     | 5.6     | 1.6     | 8.0     | 12.0   | Q1            |
| LM2902KDR       | SOIC         | D               | 14   | 2500 | 330.0              | 16.4               | 6.5     | 9.0     | 2.1     | 8.0     | 16.0   | Q1            |
| LM2902KNSR      | SO           | NS              | 14   | 2000 | 330.0              | 16.4               | 8.2     | 10.5    | 2.5     | 12.0    | 16.0   | Q1            |
| LM2902KPWR      | TSSOP        | PW              | 14   | 2000 | 330.0              | 12.4               | 6.9     | 5.6     | 1.6     | 8.0     | 12.0   | Q1            |
| LM2902KVQPWR    | TSSOP        | PW              | 14   | 2000 | 330.0              | 12.4               | 6.9     | 5.6     | 1.6     | 8.0     | 12.0   | Q1            |
| LM2902KVQPWRG4  | TSSOP        | PW              | 14   | 2000 | 330.0              | 12.4               | 6.9     | 5.6     | 1.6     | 8.0     | 12.0   | Q1            |
| LM2902NSR       | SO           | NS              | 14   | 2000 | 330.0              | 16.4               | 8.2     | 10.5    | 2.5     | 12.0    | 16.0   | Q1            |
| LM2902PWR       | TSSOP        | PW              | 14   | 2000 | 330.0              | 12.4               | 6.9     | 5.6     | 1.6     | 8.0     | 12.0   | Q1            |
| LM2902PWR       | TSSOP        | PW              | 14   | 2000 | 330.0              | 12.4               | 6.9     | 5.6     | 1.6     | 8.0     | 12.0   | Q1            |
| LM2902PWRG3     | TSSOP        | PW              | 14   | 2000 | 330.0              | 12.4               | 6.9     | 5.6     | 1.6     | 8.0     | 12.0   | Q1            |
| LM2902PWRG4     | TSSOP        | PW              | 14   | 2000 | 330.0              | 12.4               | 6.9     | 5.6     | 1.6     | 8.0     | 12.0   | Q1            |
| LM324ADR        | SOIC         | D               | 14   | 2500 | 330.0              | 16.4               | 6.5     | 9.0     | 2.1     | 8.0     | 16.0   | Q1            |
| LM324ADR        | SOIC         | D               | 14   | 2500 | 330.0              | 16.8               | 6.5     | 9.5     | 2.1     | 8.0     | 16.0   | Q1            |
| LM324ADRG4      | SOIC         | D               | 14   | 2500 | 330.0              | 16.4               | 6.5     | 9.0     | 2.1     | 8.0     | 16.0   | Q1            |
| LM324ANSR       | SO           | NS              | 14   | 2000 | 330.0              | 16.4               | 8.2     | 10.5    | 2.5     | 12.0    | 16.0   | Q1            |
| LM324APWR       | TSSOP        | PW              | 14   | 2000 | 330.0              | 12.4               | 6.9     | 5.6     | 1.6     | 8.0     | 12.0   | Q1            |
| LM324APWR       | TSSOP        | PW              | 14   | 2000 | 330.0              | 12.4               | 6.9     | 5.6     | 1.6     | 8.0     | 12.0   | Q1            |
| LM324APWRG4     | TSSOP        | PW              | 14   | 2000 | 330.0              | 12.4               | 6.9     | 5.6     | 1.6     | 8.0     | 12.0   | Q1            |
| LM324DR         | SOIC         | D               | 14   | 2500 | 330.0              | 17.0               | 6.4     | 9.05    | 2.1     | 8.0     | 16.0   | Q1            |
| LM324DR         | SOIC         | D               | 14   | 2500 | 330.0              | 16.4               | 6.5     | 9.0     | 2.1     | 8.0     | 16.0   | Q1            |
| LM324DR         | SOIC         | D               | 14   | 2500 | 330.0              | 16.4               | 6.5     | 9.0     | 2.1     | 8.0     | 16.0   | Q1            |
| LM324DRG3       | SOIC         | D               | 14   | 2500 | 330.0              | 16.8               | 6.5     | 9.5     | 2.1     | 8.0     | 16.0   | Q1            |
| LM324DRG3       | SOIC         | D               | 14   | 2500 | 330.0              | 17.0               | 6.4     | 9.05    | 2.1     | 8.0     | 16.0   | Q1            |
| LM324DRG4       | SOIC         | D               | 14   | 2500 | 330.0              | 16.4               | 6.5     | 9.0     | 2.1     | 8.0     | 16.0   | Q1            |
| LM324KADR       | SOIC         | D               | 14   | 2500 | 330.0              | 16.4               | 6.5     | 9.0     | 2.1     | 8.0     | 16.0   | Q1            |
| LM324KANSR      | SO           | NS              | 14   | 2000 | 330.0              | 16.4               | 8.2     | 10.5    | 2.5     | 12.0    | 16.0   | Q1            |
| LM324KAPWR      | TSSOP        | PW              | 14   | 2000 | 330.0              | 12.4               | 6.9     | 5.6     | 1.6     | 8.0     | 12.0   | Q1            |
| LM324KDR        | SOIC         | D               | 14   | 2500 | 330.0              | 16.4               | 6.5     | 9.0     | 2.1     | 8.0     | 16.0   | Q1            |
| LM324KNSR       | SO           | NS              | 14   | 2000 | 330.0              | 16.4               | 8.2     | 10.5    | 2.5     | 12.0    | 16.0   | Q1            |
| LM324KPWR       | TSSOP        | PW              | 14   | 2000 | 330.0              | 12.4               | 6.9     | 5.6     | 1.6     | 8.0     | 12.0   | Q1            |
| LM324PWR        | TSSOP        | PW              | 14   | 2000 | 330.0              | 12.4               | 6.9     | 5.6     | 1.6     | 8.0     | 12.0   | Q1            |
| LM324PWR        | TSSOP        | PW              | 14   | 2000 | 330.0              | 12.4               | 6.9     | 5.6     | 1.6     | 8.0     | 12.0   | Q1            |
| LM324PWRG3      | TSSOP        | PW              | 14   | 2000 | 330.0              | 12.4               | 6.9     | 5.6     | 1.6     | 8.0     | 12.0   | Q1            |
| LM324PWRG4      | TSSOP        | PW              | 14   | 2000 | 330.0              | 12.4               | 6.9     | 5.6     | 1.6     | 8.0     | 12.0   | Q1            |

**TAPE AND REEL BOX DIMENSIONS**

\*All dimensions are nominal

| Device          | Package Type | Package Drawing | Pins | SPQ  | Length (mm) | Width (mm) | Height (mm) |
|-----------------|--------------|-----------------|------|------|-------------|------------|-------------|
| LM124DR         | SOIC         | D               | 14   | 2500 | 350.0       | 350.0      | 43.0        |
| LM224ADR        | SOIC         | D               | 14   | 2500 | 367.0       | 367.0      | 38.0        |
| LM224ADR        | SOIC         | D               | 14   | 2500 | 364.0       | 364.0      | 27.0        |
| LM224ADR        | SOIC         | D               | 14   | 2500 | 333.2       | 345.9      | 28.6        |
| LM224ADRG4      | SOIC         | D               | 14   | 2500 | 367.0       | 367.0      | 38.0        |
| LM224ADRG4      | SOIC         | D               | 14   | 2500 | 333.2       | 345.9      | 28.6        |
| LM224DR         | SOIC         | D               | 14   | 2500 | 333.2       | 345.9      | 28.6        |
| LM224DR         | SOIC         | D               | 14   | 2500 | 367.0       | 367.0      | 38.0        |
| LM224DRG3       | SOIC         | D               | 14   | 2500 | 364.0       | 364.0      | 27.0        |
| LM224DRG3       | SOIC         | D               | 14   | 2500 | 333.2       | 345.9      | 28.6        |
| LM224KADR       | SOIC         | D               | 14   | 2500 | 367.0       | 367.0      | 38.0        |
| LM224KDR        | SOIC         | D               | 14   | 2500 | 367.0       | 367.0      | 38.0        |
| LM2902DR        | SOIC         | D               | 14   | 2500 | 333.2       | 345.9      | 28.6        |
| LM2902DR        | SOIC         | D               | 14   | 2500 | 333.2       | 345.9      | 28.6        |
| LM2902DR        | SOIC         | D               | 14   | 2500 | 367.0       | 367.0      | 38.0        |
| LM2902DRG3      | SOIC         | D               | 14   | 2500 | 364.0       | 364.0      | 27.0        |
| LM2902DRG4      | SOIC         | D               | 14   | 2500 | 333.2       | 345.9      | 28.6        |
| LM2902KAVQPWR   | TSSOP        | PW              | 14   | 2000 | 367.0       | 367.0      | 35.0        |
| LM2902KAVQPWRG4 | TSSOP        | PW              | 14   | 2000 | 367.0       | 367.0      | 35.0        |
| LM2902KDR       | SOIC         | D               | 14   | 2500 | 367.0       | 367.0      | 38.0        |

| Device         | Package Type | Package Drawing | Pins | SPQ  | Length (mm) | Width (mm) | Height (mm) |
|----------------|--------------|-----------------|------|------|-------------|------------|-------------|
| LM2902KNSR     | SO           | NS              | 14   | 2000 | 367.0       | 367.0      | 38.0        |
| LM2902KPWR     | TSSOP        | PW              | 14   | 2000 | 367.0       | 367.0      | 35.0        |
| LM2902KVQPWR   | TSSOP        | PW              | 14   | 2000 | 367.0       | 367.0      | 35.0        |
| LM2902KVQPWRG4 | TSSOP        | PW              | 14   | 2000 | 367.0       | 367.0      | 35.0        |
| LM2902NSR      | SO           | NS              | 14   | 2000 | 367.0       | 367.0      | 38.0        |
| LM2902PWR      | TSSOP        | PW              | 14   | 2000 | 367.0       | 367.0      | 35.0        |
| LM2902PWR      | TSSOP        | PW              | 14   | 2000 | 364.0       | 364.0      | 27.0        |
| LM2902PWRG3    | TSSOP        | PW              | 14   | 2000 | 364.0       | 364.0      | 27.0        |
| LM2902PWRG4    | TSSOP        | PW              | 14   | 2000 | 367.0       | 367.0      | 35.0        |
| LM324ADR       | SOIC         | D               | 14   | 2500 | 367.0       | 367.0      | 38.0        |
| LM324ADR       | SOIC         | D               | 14   | 2500 | 364.0       | 364.0      | 27.0        |
| LM324ADRG4     | SOIC         | D               | 14   | 2500 | 367.0       | 367.0      | 38.0        |
| LM324ANSR      | SO           | NS              | 14   | 2000 | 367.0       | 367.0      | 38.0        |
| LM324APWR      | TSSOP        | PW              | 14   | 2000 | 364.0       | 364.0      | 27.0        |
| LM324APWR      | TSSOP        | PW              | 14   | 2000 | 367.0       | 367.0      | 35.0        |
| LM324APWRG4    | TSSOP        | PW              | 14   | 2000 | 367.0       | 367.0      | 35.0        |
| LM324DR        | SOIC         | D               | 14   | 2500 | 333.2       | 345.9      | 28.6        |
| LM324DR        | SOIC         | D               | 14   | 2500 | 367.0       | 367.0      | 38.0        |
| LM324DR        | SOIC         | D               | 14   | 2500 | 333.2       | 345.9      | 28.6        |
| LM324DRG3      | SOIC         | D               | 14   | 2500 | 364.0       | 364.0      | 27.0        |
| LM324DRG3      | SOIC         | D               | 14   | 2500 | 333.2       | 345.9      | 28.6        |
| LM324DRG4      | SOIC         | D               | 14   | 2500 | 333.2       | 345.9      | 28.6        |
| LM324KADR      | SOIC         | D               | 14   | 2500 | 367.0       | 367.0      | 38.0        |
| LM324KANSR     | SO           | NS              | 14   | 2000 | 367.0       | 367.0      | 38.0        |
| LM324KAPWR     | TSSOP        | PW              | 14   | 2000 | 367.0       | 367.0      | 35.0        |
| LM324KDR       | SOIC         | D               | 14   | 2500 | 367.0       | 367.0      | 38.0        |
| LM324KNSR      | SO           | NS              | 14   | 2000 | 367.0       | 367.0      | 38.0        |
| LM324KPWR      | TSSOP        | PW              | 14   | 2000 | 367.0       | 367.0      | 35.0        |
| LM324PWR       | TSSOP        | PW              | 14   | 2000 | 367.0       | 367.0      | 35.0        |
| LM324PWR       | TSSOP        | PW              | 14   | 2000 | 364.0       | 364.0      | 27.0        |
| LM324PWRG3     | TSSOP        | PW              | 14   | 2000 | 364.0       | 364.0      | 27.0        |
| LM324PWRG4     | TSSOP        | PW              | 14   | 2000 | 367.0       | 367.0      | 35.0        |

W (R-GDFP-F14)

CERAMIC DUAL FLATPACK



- NOTES:
- A. All linear dimensions are in inches (millimeters).
  - B. This drawing is subject to change without notice.
  - C. This package can be hermetically sealed with a ceramic lid using glass frit.
  - D. Index point is provided on cap for terminal identification only.
  - E. Falls within MIL STD 1835 GDFP1-F14

J 14

**GENERIC PACKAGE VIEW**  
**CDIP - 5.08 mm max height**  
CERAMIC DUAL IN LINE PACKAGE



Images above are just a representation of the package family, actual package may vary.  
Refer to the product data sheet for package details.

4040083-5/G

J0014A



# PACKAGE OUTLINE

CDIP - 5.08 mm max height

CERAMIC DUAL IN LINE PACKAGE



4214771/A 05/2017

NOTES:

1. All controlling linear dimensions are in inches. Dimensions in brackets are in millimeters. Any dimension in brackets or parenthesis are for reference only. Dimensioning and tolerancing per ASME Y14.5M.
2. This drawing is subject to change without notice.
3. This package is hermetically sealed with a ceramic lid using glass frit.
4. Index point is provided on cap for terminal identification only and on press ceramic glass frit seal only.
5. Falls within MIL-STD-1835 and GDIP1-T14.

# EXAMPLE BOARD LAYOUT

J0014A

CDIP - 5.08 mm max height

CERAMIC DUAL IN LINE PACKAGE



LAND PATTERN EXAMPLE  
NON-SOLDER MASK DEFINED  
SCALE: 5X



4214771/A 05/2017



D (R-PDSO-G14)

PLASTIC SMALL OUTLINE

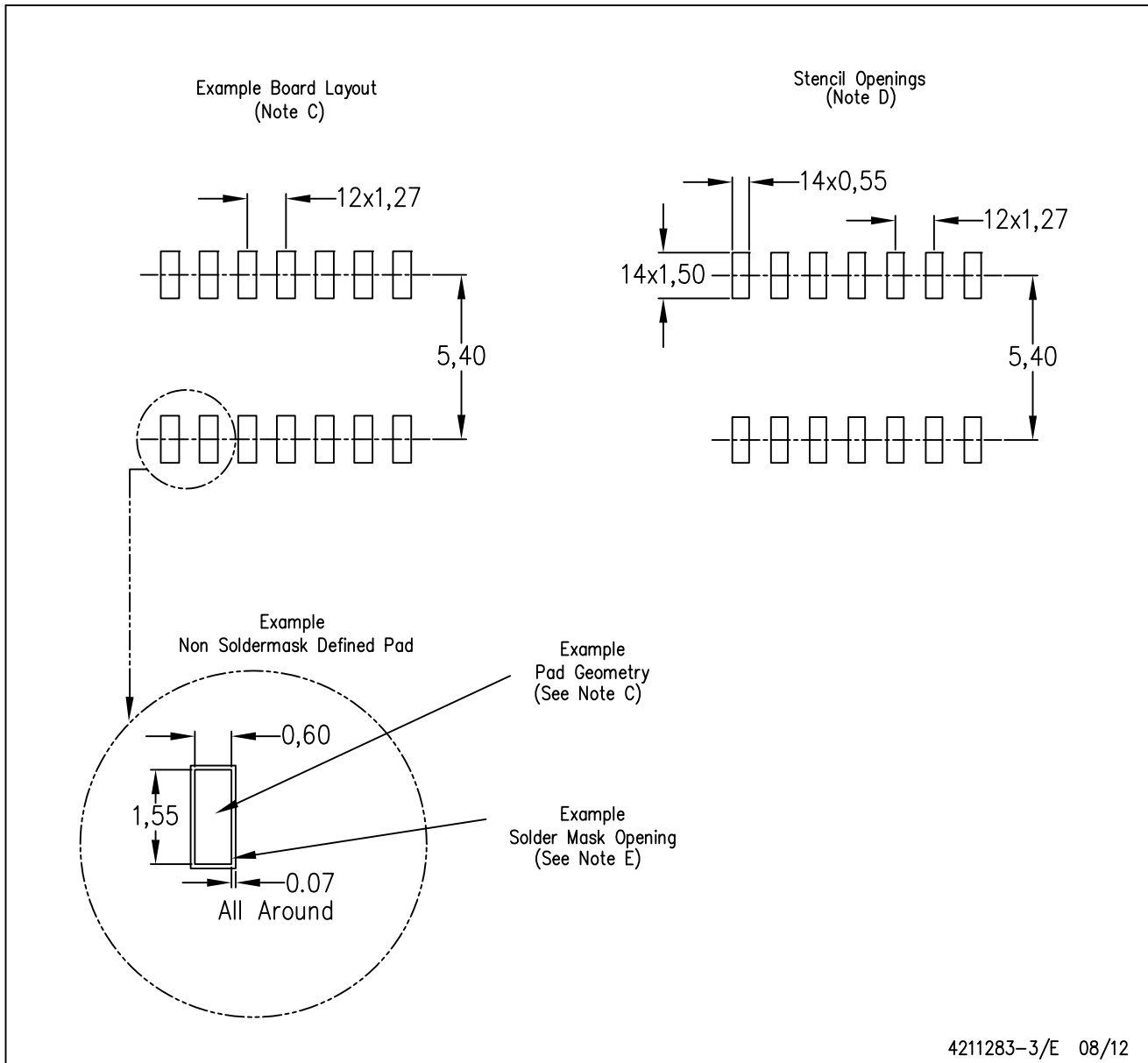

4211283-3/E 08/12

- NOTES:
- All linear dimensions are in millimeters.
  - This drawing is subject to change without notice.
  - Publication IPC-7351 is recommended for alternate designs.
  - Laser cutting apertures with trapezoidal walls and also rounding corners will offer better paste release. Customers should contact their board assembly site for stencil design recommendations. Refer to IPC-7525 for other stencil recommendations.
  - Customers should contact their board fabrication site for solder mask tolerances between and around signal pads.



PW (R-PDSO-G14)

PLASTIC SMALL OUTLINE



4211284-2/G 08/15

- NOTES:
- A. All linear dimensions are in millimeters.
  - B. This drawing is subject to change without notice.
  - C. Publication IPC-7351 is recommended for alternate designs.
  - D. Laser cutting apertures with trapezoidal walls and also rounding corners will offer better paste release. Customers should contact their board assembly site for stencil design recommendations. Refer to IPC-7525 for other stencil recommendations.
  - E. Customers should contact their board fabrication site for solder mask tolerances between and around signal pads.

N (R-PDIP-T\*\*)

PLASTIC DUAL-IN-LINE PACKAGE

16 PINS SHOWN



- NOTES:
- A. All linear dimensions are in inches (millimeters).
  - B. This drawing is subject to change without notice.
  - Falls within JEDEC MS-001, except 18 and 20 pin minimum body length (Dim A).
  - The 20 pin end lead shoulder width is a vendor option, either half or full width.



FK (S-CQCC-N\*\*)

LEADLESS CERAMIC CHIP CARRIER

28 TERMINAL SHOWN



| NO. OF TERMINALS ** | A                |                  | B                |                  |
|---------------------|------------------|------------------|------------------|------------------|
|                     | MIN              | MAX              | MIN              | MAX              |
| 20                  | 0.342<br>(8,69)  | 0.358<br>(9,09)  | 0.307<br>(7,80)  | 0.358<br>(9,09)  |
| 28                  | 0.442<br>(11,23) | 0.458<br>(11,63) | 0.406<br>(10,31) | 0.458<br>(11,63) |
| 44                  | 0.640<br>(16,26) | 0.660<br>(16,76) | 0.495<br>(12,58) | 0.560<br>(14,22) |
| 52                  | 0.740<br>(18,78) | 0.761<br>(19,32) | 0.495<br>(12,58) | 0.560<br>(14,22) |
| 68                  | 0.938<br>(23,83) | 0.962<br>(24,43) | 0.850<br>(21,6)  | 0.858<br>(21,8)  |
| 84                  | 1.141<br>(28,99) | 1.165<br>(29,59) | 1.047<br>(26,6)  | 1.063<br>(27,0)  |



4040140/D 01/11

- NOTES:
- All linear dimensions are in inches (millimeters).
  - This drawing is subject to change without notice.
  - This package can be hermetically sealed with a metal lid.
  - Falls within JEDEC MS-004

# MECHANICAL DATA

NS (R-PDSO-G\*\*)

PLASTIC SMALL-OUTLINE PACKAGE

14-PINS SHOWN



- NOTES:
- A. All linear dimensions are in millimeters.
  - B. This drawing is subject to change without notice.
  - C. Body dimensions do not include mold flash or protrusion, not to exceed 0,15.

## IMPORTANT NOTICE AND DISCLAIMER

TI PROVIDES TECHNICAL AND RELIABILITY DATA (INCLUDING DATASHEETS), DESIGN RESOURCES (INCLUDING REFERENCE DESIGNS), APPLICATION OR OTHER DESIGN ADVICE, WEB TOOLS, SAFETY INFORMATION, AND OTHER RESOURCES "AS IS" AND WITH ALL FAULTS, AND DISCLAIMS ALL WARRANTIES, EXPRESS AND IMPLIED, INCLUDING WITHOUT LIMITATION ANY IMPLIED WARRANTIES OF MERCHANTABILITY, FITNESS FOR A PARTICULAR PURPOSE OR NON-INFRINGEMENT OF THIRD PARTY INTELLECTUAL PROPERTY RIGHTS.

These resources are intended for skilled developers designing with TI products. You are solely responsible for (1) selecting the appropriate TI products for your application, (2) designing, validating and testing your application, and (3) ensuring your application meets applicable standards, and any other safety, security, or other requirements. These resources are subject to change without notice. TI grants you permission to use these resources only for development of an application that uses the TI products described in the resource. Other reproduction and display of these resources is prohibited. No license is granted to any other TI intellectual property right or to any third party intellectual property right. TI disclaims responsibility for, and you will fully indemnify TI and its representatives against, any claims, damages, costs, losses, and liabilities arising out of your use of these resources.

TI's products are provided subject to TI's Terms of Sale ([www.ti.com/legal/termsofsale.html](http://www.ti.com/legal/termsofsale.html)) or other applicable terms available either on [ti.com](http://ti.com) or provided in conjunction with such TI products. TI's provision of these resources does not expand or otherwise alter TI's applicable warranties or warranty disclaimers for TI products.

Mailing Address: Texas Instruments, Post Office Box 655303, Dallas, Texas 75265  
Copyright © 2019, Texas Instruments Incorporated

## Looking for pricing, stock, or lifecycle information?

Click below to explore more details on WIN SOURCE:

 [View LM324KANSR](#) on WIN SOURCE

 [Texas Instruments](#) Information

## Optimize Your Supply Chain with WIN SOURCE Solutions

-  Global Sourcing Solution
-  Obsolete Management
-  Cost Control Management
-  Shortage Management
-  Alternative Solution
-  Excess Inventory Management