



**THE DATASHEET OF
IRLTS6342TRPBF**



IRLTS6342PbF

HEXFET® Power MOSFET

V_{DS}	30	V
V_{GS}	±12	V
$R_{DS(on) \max}$ (@ $V_{GS} = 4.5V$)	17.5	mΩ
$R_{DS(on) \max}$ (@ $V_{GS} = 2.5V$)	22.0	mΩ
Q_g (typical)	11	nC
I_D (@ $T_A = 25^\circ C$)	8.3	A

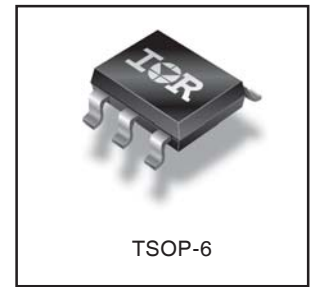
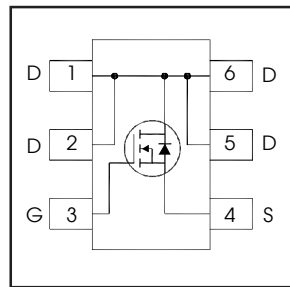

Applications

- System/Load Switch

Features and Benefits

Features

Industry-Standard TSOP-6 Package
RoHS Compliant Containing no Lead, no Bromide and no Halogen
MSL1, Consumer Qualification



Resulting Benefits

Multi-Vendor Compatibility
Environmentally Friendlier
Increased Reliability

Orderable part number	Package Type	Standard Pack		Note
		Form	Quantity	
IRLTS6342TRPBF	TSOP-6	Tape and Reel	3000	

Absolute Maximum Ratings

	Parameter	Max.	Units
V_{DS}	Drain-to-Source Voltage	30	V
V_{GS}	Gate-to-Source Voltage	±12	
$I_D @ T_A = 25^\circ C$	Continuous Drain Current, $V_{GS} @ 4.5V$	8.3	A
$I_D @ T_A = 70^\circ C$	Continuous Drain Current, $V_{GS} @ 4.5V$	6.7	
I_{DM}	Pulsed Drain Current ①	64	
$P_D @ T_A = 25^\circ C$	Power Dissipation ③	2.0	W
$P_D @ T_A = 70^\circ C$	Power Dissipation ③	1.3	
	Linear Derating Factor	0.02	W/°C
T_J	Operating Junction and	-55 to + 150	°C
T_{STG}	Storage Temperature Range		

Notes ① through ④ are on page 2

Static @ T_J = 25°C (unless otherwise specified)

	Parameter	Min.	Typ.	Max.	Units	Conditions
BV _{DSS}	Drain-to-Source Breakdown Voltage	30	—	—	V	V _{GS} = 0V, I _D = 250μA
ΔBV _{DSS} /ΔT _J	Breakdown Voltage Temp. Coefficient	—	23	—	mV/°C	Reference to 25°C, I _D = 1mA
R _{DS(on)}	Static Drain-to-Source On-Resistance	—	14.0	17.5	mΩ	V _{GS} = 4.5V, I _D = 8.3A ②
		—	17.5	22.0		V _{GS} = 2.5V, I _D = 6.7A ②
V _{GS(th)}	Gate Threshold Voltage	0.5	—	1.1	V	V _{DS} = V _{GS} , I _D = 10μA
ΔV _{GS(th)}	Gate Threshold Voltage Coefficient	—	-4.3	—	mV/°C	
I _{DSS}	Drain-to-Source Leakage Current	—	—	1.0	μA	V _{DS} = 24V, V _{GS} = 0V
		—	—	150		V _{DS} = 24V, V _{GS} = 0V, T _J = 125°C
I _{GSS}	Gate-to-Source Forward Leakage	—	—	100	nA	V _{GS} = 12V
	Gate-to-Source Reverse Leakage	—	—	-100		V _{GS} = -12V
g _{fs}	Forward Transconductance	25	—	—	S	V _{DS} = 10V, I _D = 6.4A
Q _g	Total Gate Charge	—	11	—	nC	V _{GS} = 4.5V
Q _{gs}	Gate-to-Source Charge	—	0.5	—		V _{DS} = 15V
Q _{gd}	Gate-to-Drain Charge	—	4.6	—		I _D = 6.4A
R _G	Gate Resistance	—	2.2	—	Ω	
t _{d(on)}	Turn-On Delay Time	—	5.4	—	ns	V _{DD} = 15V, V _{GS} = 4.5V ③
t _r	Rise Time	—	11	—		I _D = 6.4A
t _{d(off)}	Turn-Off Delay Time	—	32	—		R _G = 6.8Ω
t _f	Fall Time	—	15	—		See Figs. 18
C _{iss}	Input Capacitance	—	1010	—	pF	V _{GS} = 0V
C _{oss}	Output Capacitance	—	96	—		V _{DS} = 25V
C _{rss}	Reverse Transfer Capacitance	—	70	—		f = 1.0MHz

Diode Characteristics

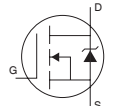
	Parameter	Min.	Typ.	Max.	Units	Conditions
I _S	Continuous Source Current (Body Diode)	—	—	2.0	A	MOSFET symbol showing the integral reverse p-n junction diode. 
I _{SM}	Pulsed Source Current (Body Diode) ①	—	—	64		
V _{SD}	Diode Forward Voltage	—	—	1.2	V	T _J = 25°C, I _S = 8.3A, V _{GS} = 0V ②
t _{rr}	Reverse Recovery Time	—	13	20	ns	T _J = 25°C, I _F = 6.4A, V _{DD} = 24V
Q _{rr}	Reverse Recovery Charge	—	5.8	8.7	nC	di/dt = 100/μs ②

Thermal Resistance

	Parameter	Typ.	Max.	Units
R _{θJA}	Junction-to-Ambient ③	—	62.5	°C/W

Notes:

- ① Repetitive rating; pulse width limited by max. junction temperature.
- ② Pulse width ≤ 400μs; duty cycle ≤ 2%.
- ③ When mounted on 1 inch square copper board.
- ④ R_θ is measured at T_J of approximately 90°C.

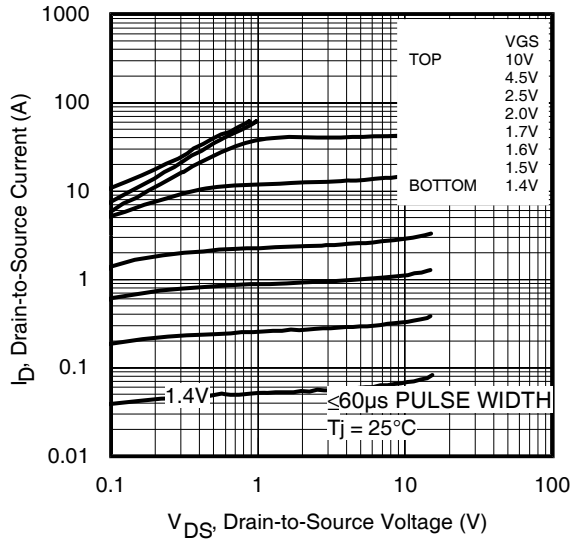

Fig 1. Typical Output Characteristics

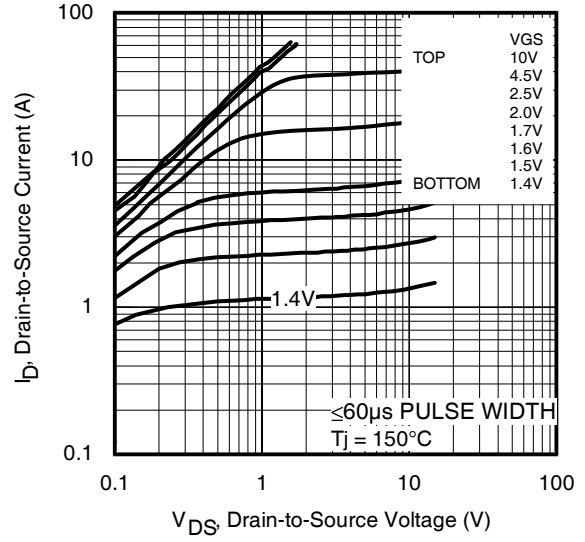

Fig 2. Typical Output Characteristics

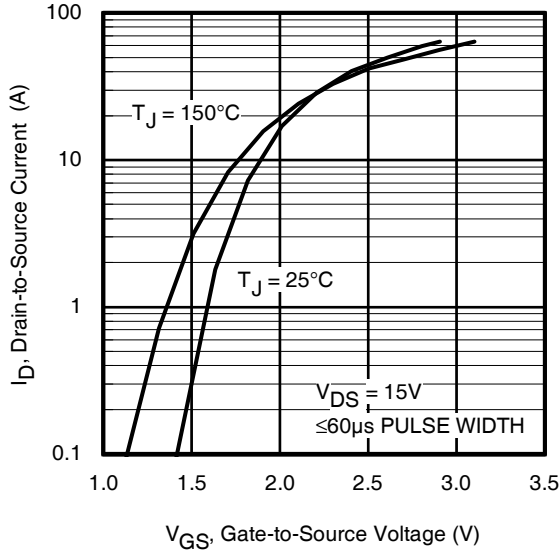

Fig 3. Typical Transfer Characteristics

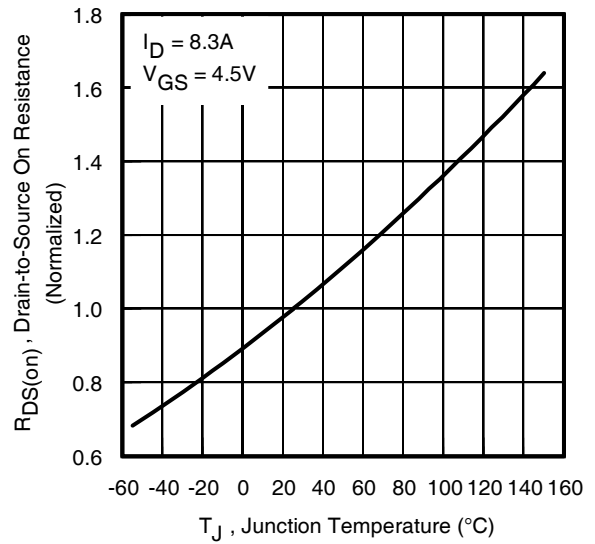

Fig 4. Normalized On-Resistance vs. Temperature

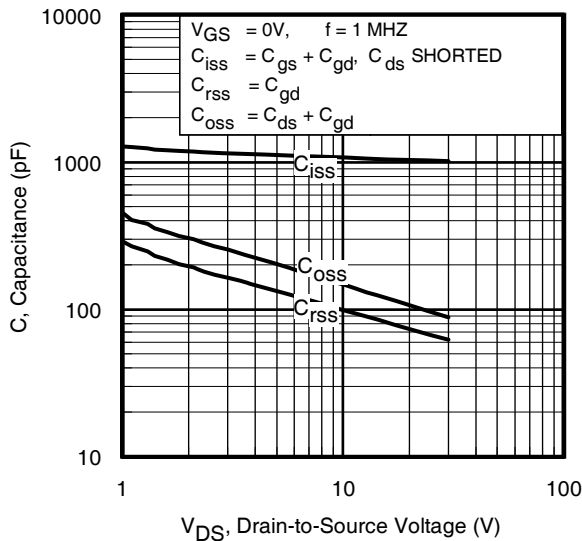

Fig 5. Typical Capacitance vs. Drain-to-Source Voltage
www.irf.com

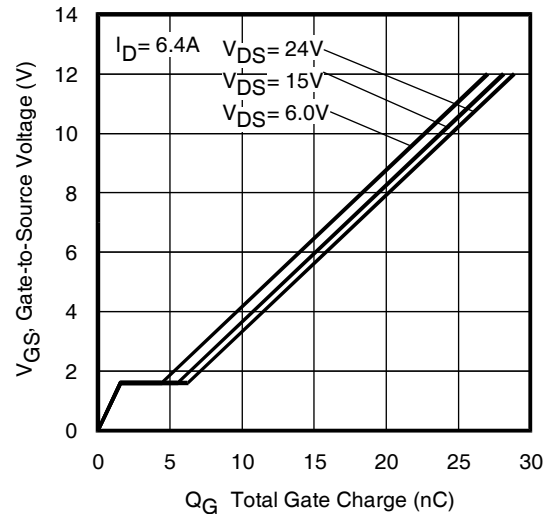

Fig 6. Typical Gate Charge vs. Gate-to-Source Voltage

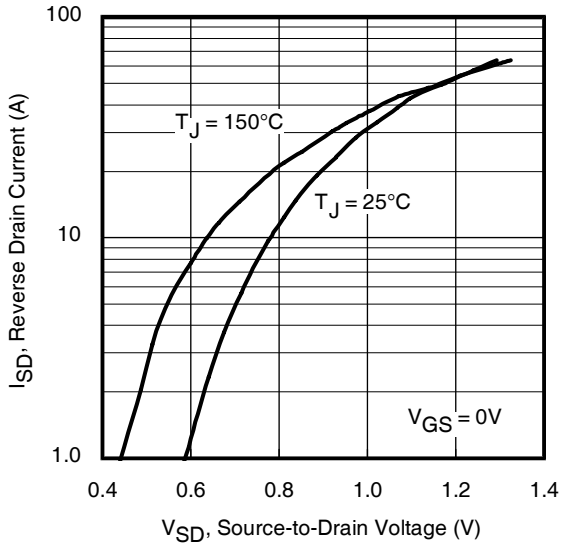

Fig 7. Typical Source-Drain Diode Forward Voltage

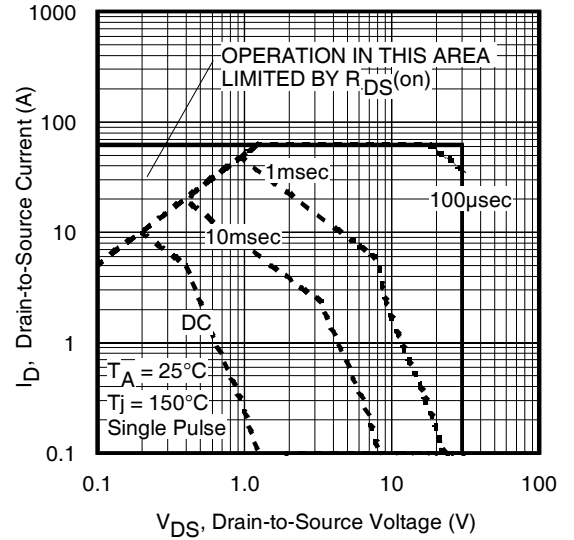

Fig 8. Maximum Safe Operating Area

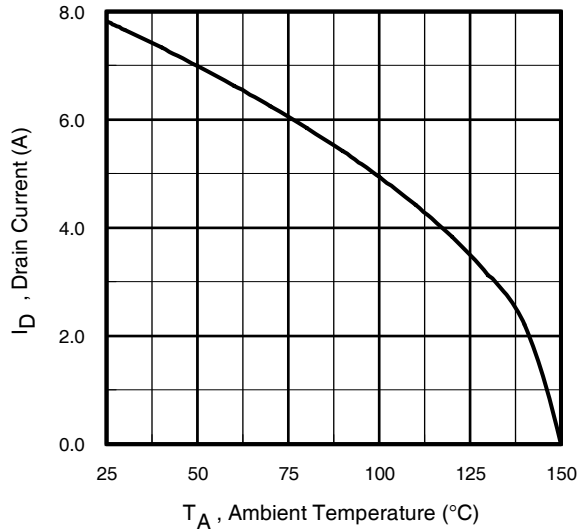

Fig 9. Maximum Drain Current vs. Ambient Temperature

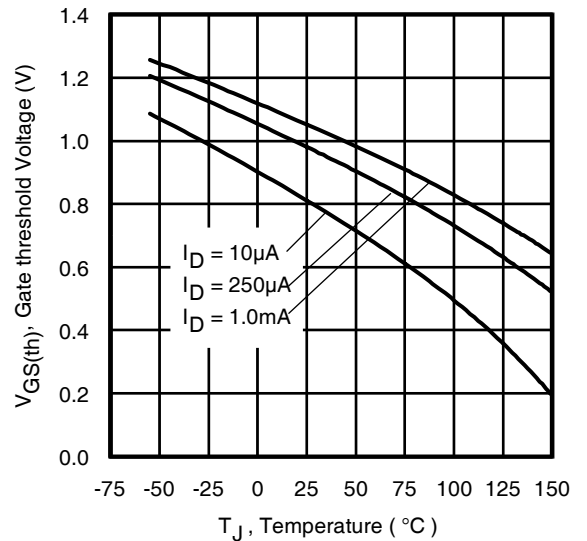

Fig 10. Threshold Voltage vs. Temperature

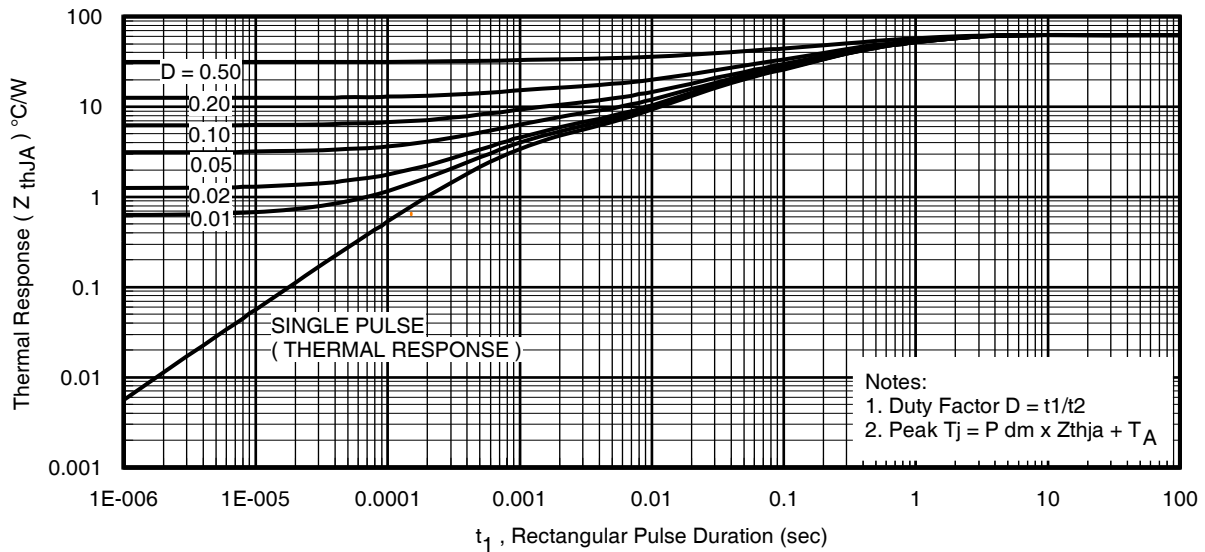

Fig 11. Maximum Effective Transient Thermal Impedance, Junction-to-Ambient

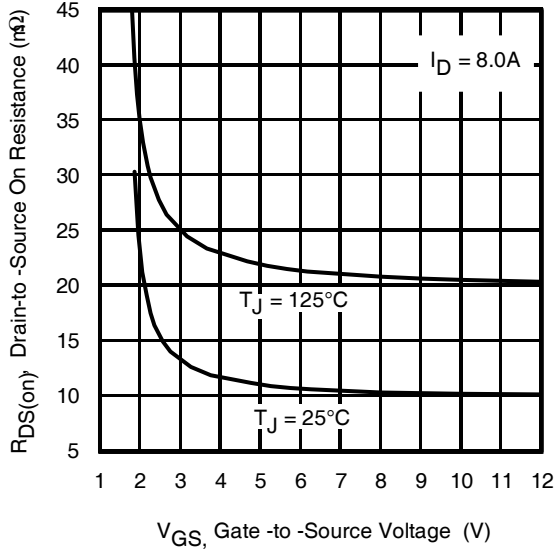

Fig 12. On-Resistance vs. Gate Voltage

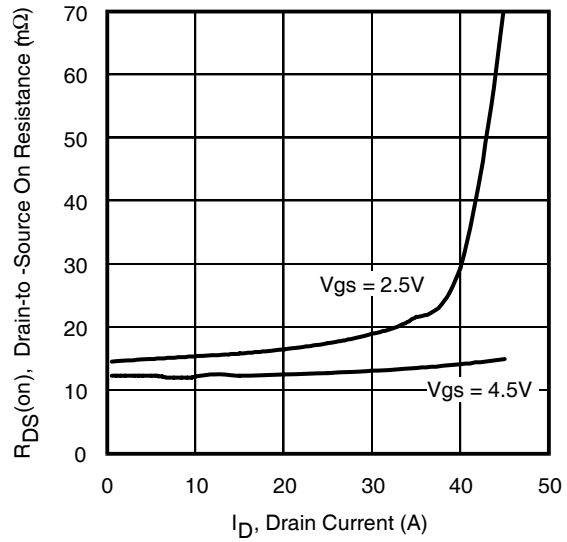

Fig 13. Typical On-Resistance vs. Drain Current

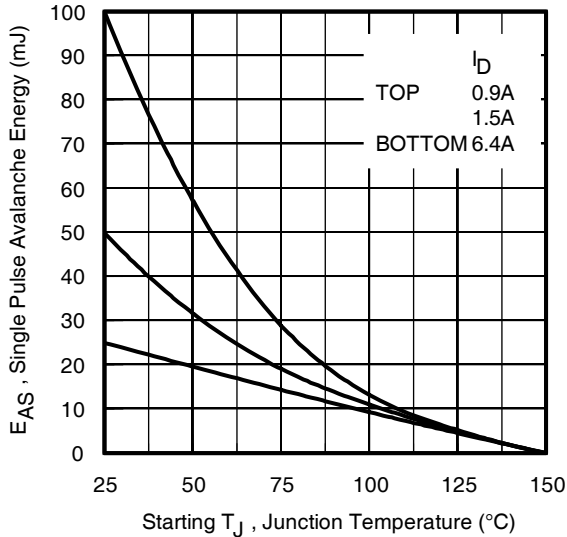

Fig 14. Maximum Avalanche Energy vs. Drain Current

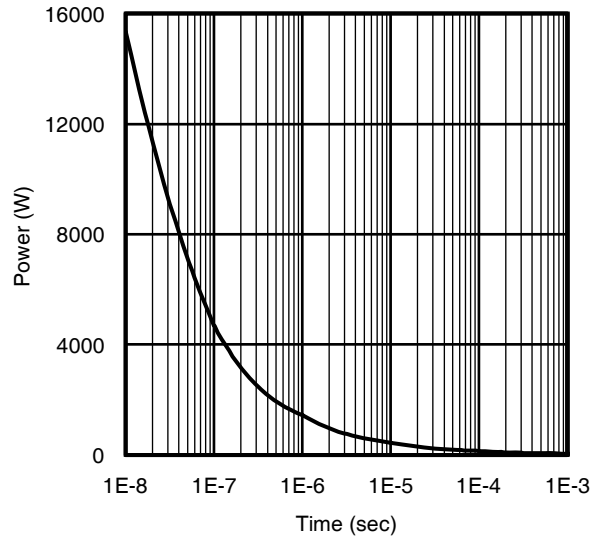
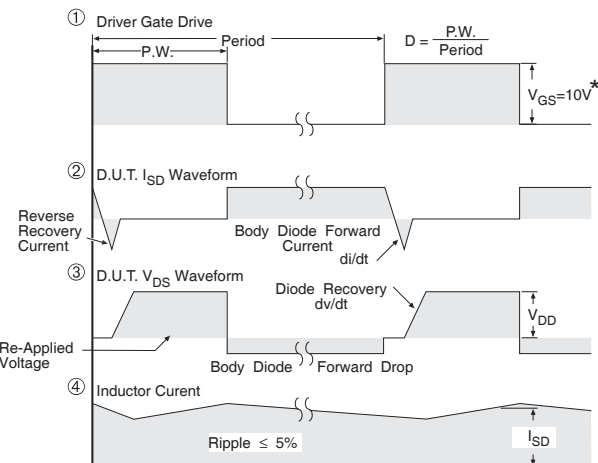
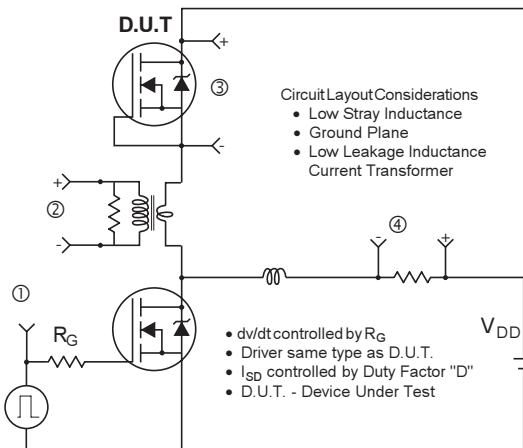

Fig 15. Typical Power vs. Time



* $V_{GS} = 5V$ for Logic Level Devices

Fig 16. Peak Diode Recovery dv/dt Test Circuit for N-Channel HEXFET® Power MOSFETs

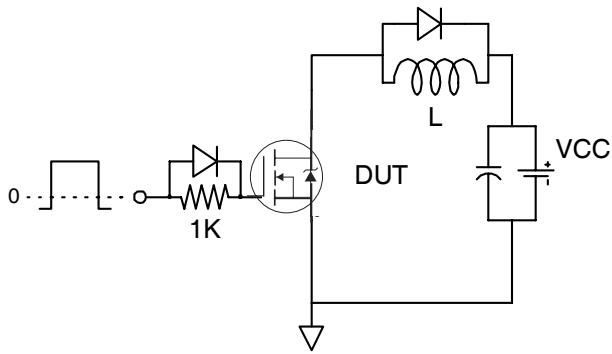

Fig 17a. Gate Charge Test Circuit

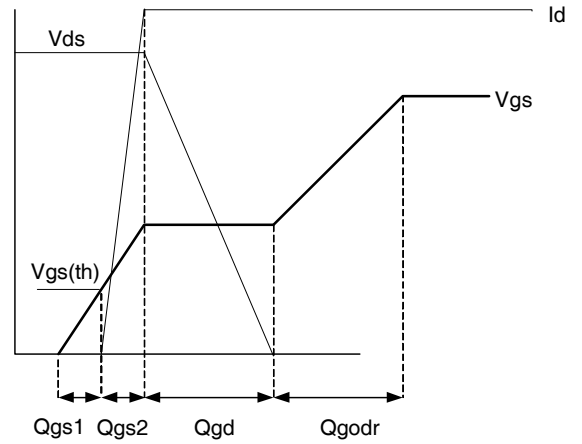

Fig 17b. Gate Charge Waveform

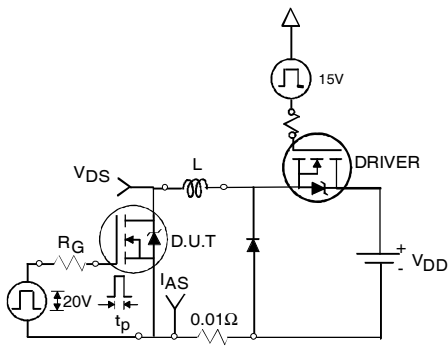

Fig 18a. Unclamped Inductive Test Circuit

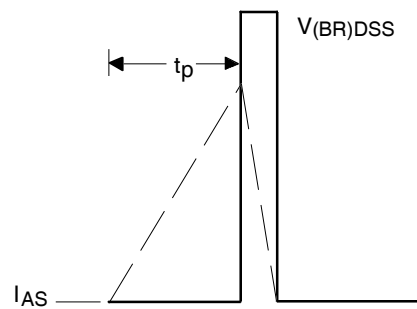

Fig 18b. Unclamped Inductive Waveforms

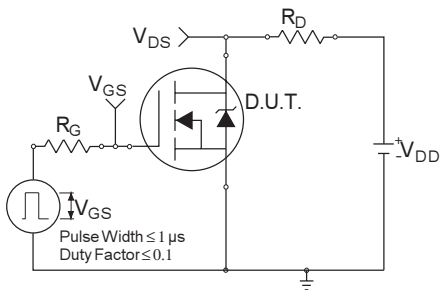

Fig 19a. Switching Time Test Circuit

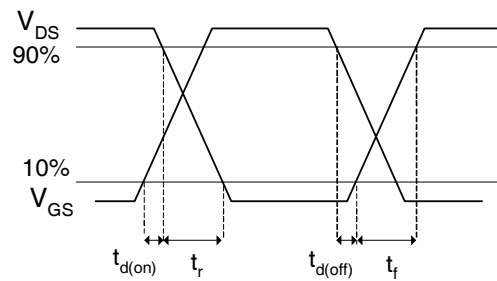
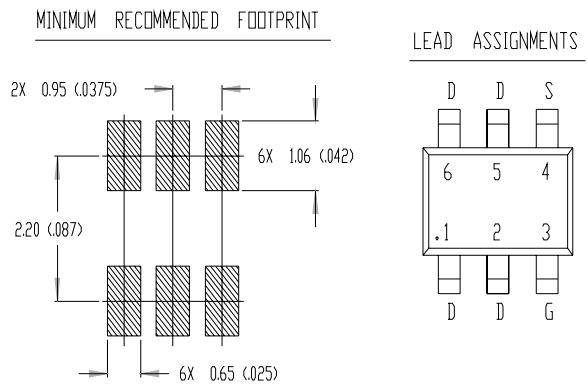
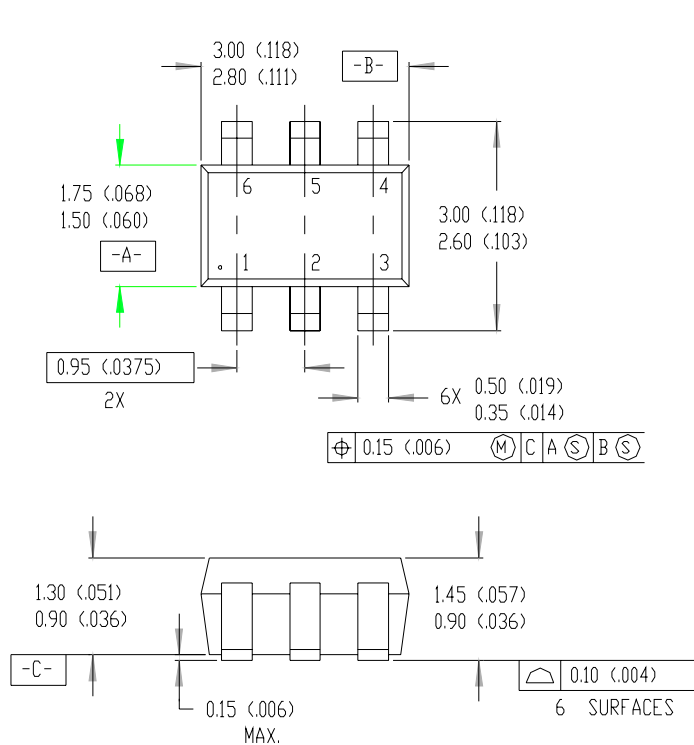
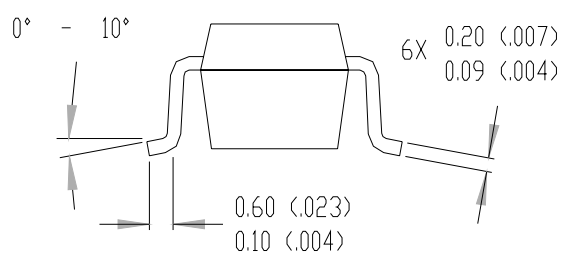

Fig 19b. Switching Time Waveforms

TSOP-6 Package Outline



- NOTES:
1. DIMENSIONING & TOLERANCING PER ANSI Y14.5M-1982.
 2. CONTROLLING DIMENSION: MILLIMETER.
 3. DIMENSIONS ARE SHOWN IN MILLIMETERS (INCHES).



TSOP-6 Part Marking Information

W = (1-26) IF PRECEDED BY LAST DIGIT OF CALENDAR YEAR

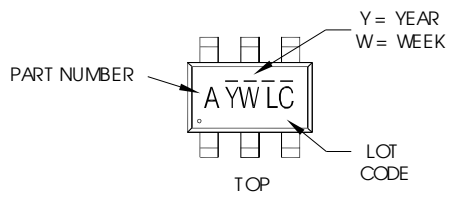

PART NUMBER CODE REFERENCE:

- A = SI3443DV
- B = IRF5800
- C = IRF5850
- D = IRF5851
- E = IRF5852
- F = IRF5801
- G = IRF5803
- H = IRF5804
- I = IRF5805
- J = IRF5806
- K = IRF5810
- N = IRF5802
- O = IRLTS6342TRPBF
- P = IRF58342TRPBF
- R = IRF59342TRPBF
- S = IRLTS2242TRPBF

Note: A line above the work week (as shown here) indicates Lead-Free.

YEAR	Y	WORK WEEK	W
2001	1	01	A
2002	2	02	B
2003	3	03	C
2004	4	04	D
2005	5		
2006	6		
2007	7		
2008	8		
2009	9		
2010	0	24	X
		25	Y
		26	Z

W = (27-52) IF PRECEDED BY A LETTER

YEAR	Y	WORK WEEK	W
2001	A	27	A
2002	B	28	B
2003	C	29	C
2004	D	30	D
2005	E		
2006	F		
2007	G		
2008	H		
2009	J		
2010	K	50	X
		51	Y
		52	Z

Note: For the most current drawing please refer to IR website at: <http://www.irf.com/package/>

TSOP-6 Tape & Reel Information

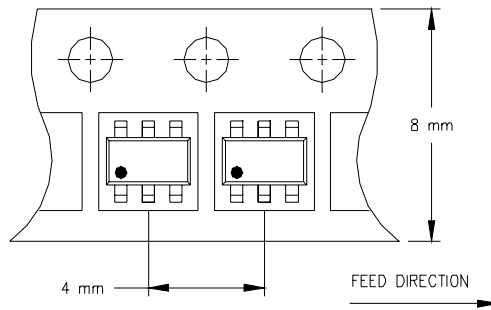

NOTES:

1. OUTLINE CONFORMS TO EIA-481 & EIA-541.

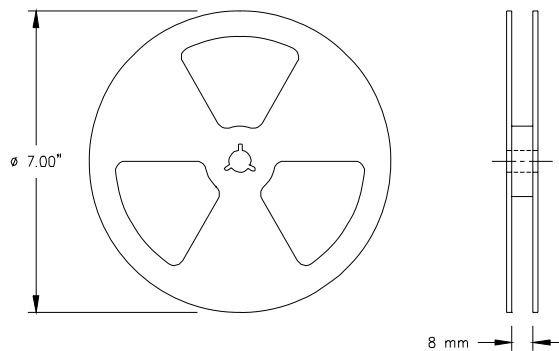

NOTES:

1. OUTLINE CONFORMS TO EIA-481 & EIA-541.

Qualification information[†]

Qualification level	Consumer ^{††} (per JEDEC JES D47F ^{†††} guidelines)	
Moisture Sensitivity Level	TSOP-6	MSL 1 (per JEDEC J-STD-020D ^{†††})
RoHS compliant	Yes	

[†] Qualification standards can be found at International Rectifier's web site

<http://www.irf.com/product-info/reliability>

^{††} Higher qualification ratings may be available should the user have such requirements.

Please contact your International Rectifier sales representative for further information:

<http://www.irf.com/whoto-call/salesrep/>

^{†††} Applicable version of JEDEC standard at the time of product release.

Data and specifications subject to change without notice.

International
IR Rectifier

IR WORLD HEADQUARTERS: 233 Kansas St., El Segundo, California 90245, USA Tel: (310) 252-7105

TAC Fax: (310) 252-7903

Visit us at www.irf.com for sales contact information.09/2011

www.irf.com

Looking for pricing, stock, or lifecycle information?

Click below to explore more details on WIN SOURCE:

 [View IRLTS6342TRPBF on WIN SOURCE](#)

 [Infineon Technologies](#) Information

Optimize Your Supply Chain with WIN SOURCE Solutions

-  Global Sourcing Solution
-  Obsolete Management
-  Cost Control Management
-  Shortage Management
-  Alternative Solution
-  Excess Inventory Management