



**THE DATASHEET OF  
PDTC114TM,315**



# PDTC114T series

NPN resistor-equipped transistors; R1 = 10 kΩ, R2 = open

Rev. 08 — 9 February 2006

Product data sheet

## 1. Product profile

### 1.1 General description

NPN Resistor-Equipped Transistors (RET) family.

Table 1: Product overview

Type number	Package			PNP complement
	Philips	JEITA	JEDEC	
PDTC114TE	SOT416	SC-75	-	PDTA114TE
PDTC114TK	SOT346	SC-59A	TO-236	PDTA114TK
PDTC114TM	SOT883	SC-101	-	PDTA114TM
PDTC114TS <a href="#">[1]</a>	SOT54	SC-43A	TO-92	PDTA114TS
PDTC114TT	SOT23	-	TO-236AB	PDTA114TT
PDTC114TU	SOT323	SC-70	-	PDTA114TU

[1] Also available in SOT54A and SOT54 variant packages (see [Section 2](#)).

### 1.2 Features

- Built-in bias resistors
- Simplifies circuit design
- 100 mA output current capability
- Reduces component count
- Reduces pick and place costs

### 1.3 Applications

- Digital applications
- Controlling IC inputs
- Cost-saving alternative for BC847 series in digital applications
- Switching loads

### 1.4 Quick reference data

Table 2: Quick reference data

Symbol	Parameter	Conditions	Min	Typ	Max	Unit
$V_{CEO}$	collector-emitter voltage	open base	-	-	50	V
$I_O$	output current		-	-	100	mA
R1	bias resistor 1 (input)		7	10	13	kΩ

**2. Pinning information**

**Table 3: Pinning**

Pin	Description	Simplified outline	Symbol
<b>SOT54</b>			
1	input (base)		
2	output (collector)		
3	GND (emitter)		
<b>SOT54A</b>			
1	input (base)		
2	output (collector)		
3	GND (emitter)		
<b>SOT54 variant</b>			
1	input (base)		
2	output (collector)		
3	GND (emitter)		
<b>SOT23; SOT323; SOT346; SOT416</b>			
1	input (base)		
2	GND (emitter)		
3	output (collector)		
<b>SOT883</b>			
1	input (base)		
2	GND (emitter)		
3	output (collector)		

### 3. Ordering information

Table 4: Ordering information

Type number	Package		
	Name	Description	Version
PDTC114TE	SC-75	plastic surface mounted package; 3 leads	SOT416
PDTC114TK	SC-59A	plastic surface mounted package; 3 leads	SOT346
PDTC114TM	SC-101	leadless ultra small plastic package; 3 solder lands; body 1.0 × 0.6 × 0.5 mm	SOT883
PDTC114TS <sup>[1]</sup>	SC-43A	plastic single-ended leaded (through hole) package; 3 leads	SOT54
PDTC114TT	-	plastic surface mounted package; 3 leads	SOT23
PDTC114TU	SC-70	plastic surface mounted package; 3 leads	SOT323

[1] Also available in SOT54A and SOT54 variant packages (see [Section 2](#) and [Section 9](#)).

### 4. Marking

Table 5: Marking codes

Type number	Marking code <sup>[1]</sup>
PDTC114TE	24
PDTC114TK	24
PDTC114TM	DT
PDTC114TS	TC114T
PDTC114TT	*12
PDTC114TU	*24

[1] \* = -: made in Hong Kong  
 \* = p: made in Hong Kong  
 \* = t: made in Malaysia  
 \* = W: made in China

## 5. Limiting values

**Table 6: Limiting values**

In accordance with the Absolute Maximum Rating System (IEC 60134).

Symbol	Parameter	Conditions	Min	Max	Unit
$V_{CBO}$	collector-base voltage	open emitter	-	50	V
$V_{CEO}$	collector-emitter voltage	open base	-	50	V
$V_{EBO}$	emitter-base voltage	open collector	-	5	V
$I_O$	output current		-	100	mA
$I_{CM}$	peak collector current	single pulse; $t_p \leq 1$ ms	-	100	mA
$P_{tot}$	total power dissipation	$T_{amb} \leq 25$ °C			
	SOT416		[1] -	150	mW
	SOT346		[1] -	250	mW
	SOT883		[2] [3] -	250	mW
	SOT54		[1] -	500	mW
	SOT23		[1] -	250	mW
	SOT323		[1] -	200	mW
$T_{stg}$	storage temperature		-65	+150	°C
$T_j$	junction temperature		-	150	°C
$T_{amb}$	ambient temperature		-65	+150	°C

[1] Device mounted on an FR4 Printed-Circuit Board (PCB), single-sided copper, tin-plated and standard footprint.

[2] Reflow soldering is the only recommended soldering method.

[3] Device mounted on an FR4 PCB with 60 μm copper strip line, standard footprint.

## 6. Thermal characteristics

**Table 7: Thermal characteristics**

Symbol	Parameter	Conditions	Min	Typ	Max	Unit
$R_{th(j-a)}$	thermal resistance from junction to ambient	in free air				
	SOT416		[1] -	-	833	K/W
	SOT346		[1] -	-	500	K/W
	SOT883		[2] [3] -	-	500	K/W
	SOT54		[1] -	-	250	K/W
	SOT23		[1] -	-	500	K/W
	SOT323		[1] -	-	625	K/W

[1] Device mounted on an FR4 PCB, single-sided copper, tin-plated and standard footprint.

[2] Reflow soldering is the only recommended soldering method.

[3] Device mounted on an FR4 PCB with 60 μm copper strip line, standard footprint.

**7. Characteristics**

**Table 8: Characteristics**  
*T<sub>amb</sub> = 25 °C unless otherwise specified.*

Symbol	Parameter	Conditions	Min	Typ	Max	Unit
I <sub>CBO</sub>	collector-base cut-off current	V <sub>CB</sub> = 50 V; I <sub>E</sub> = 0 A	-	-	100	nA
I <sub>CEO</sub>	collector-emitter cut-off current	V <sub>CE</sub> = 30 V; I <sub>B</sub> = 0 A	-	-	1	μA
		V <sub>CE</sub> = 30 V; I <sub>B</sub> = 0 A; T <sub>j</sub> = 150 °C	-	-	50	μA
I <sub>EBO</sub>	emitter-base cut-off current	V <sub>EB</sub> = 5 V; I <sub>C</sub> = 0 A	-	-	100	nA
h <sub>FE</sub>	DC current gain	V <sub>CE</sub> = 5 V; I <sub>C</sub> = 1 mA	200	-	-	
V <sub>CEsat</sub>	collector-emitter saturation voltage	I <sub>C</sub> = 10 mA; I <sub>B</sub> = 0.5 mA	-	-	150	mV
R1	bias resistor 1 (input)		7	10	13	kΩ
C <sub>c</sub>	collector capacitance	V <sub>CB</sub> = 10 V; I <sub>E</sub> = i <sub>e</sub> = 0 A; f = 1 MHz	-	-	2.5	pF

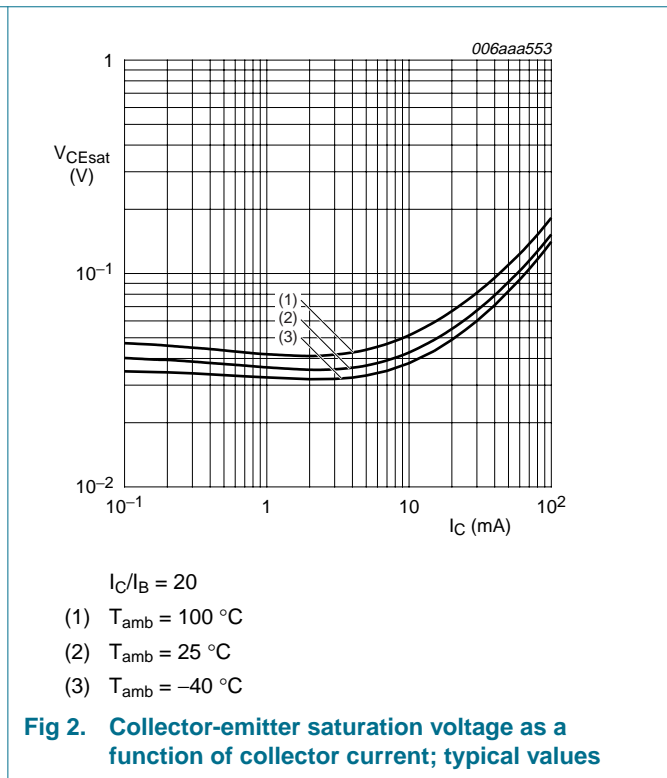
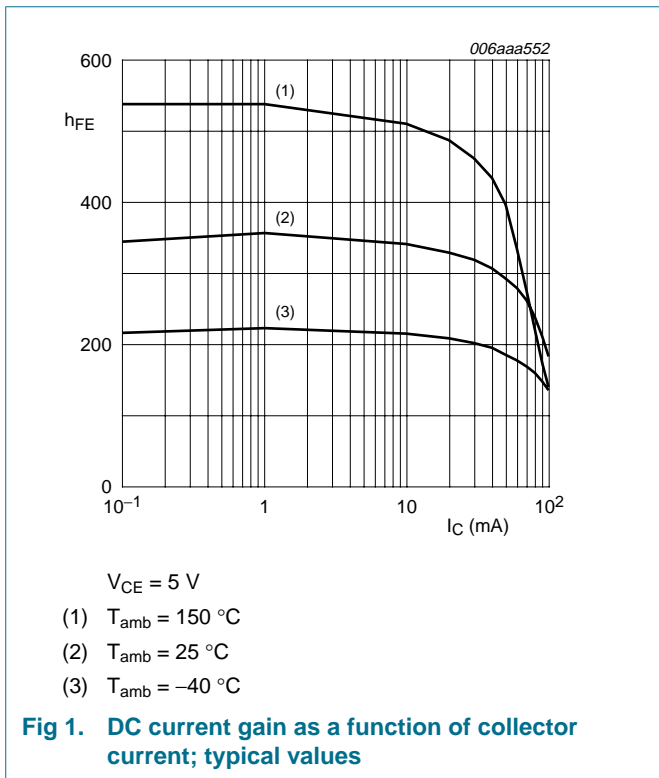

**8. Package outline**

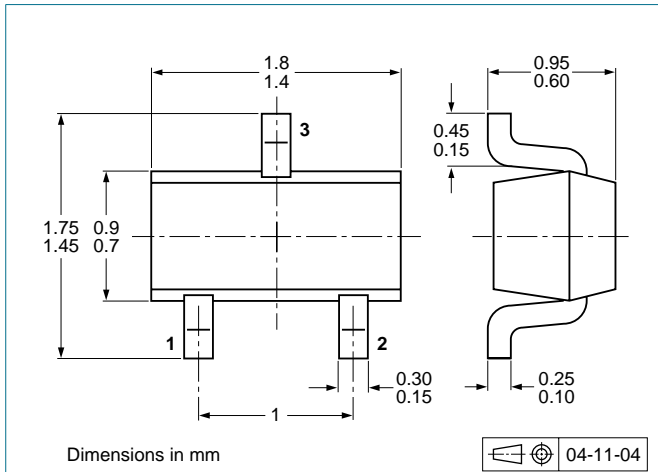

**Fig 3. Package outline SOT416 (SC-75)**

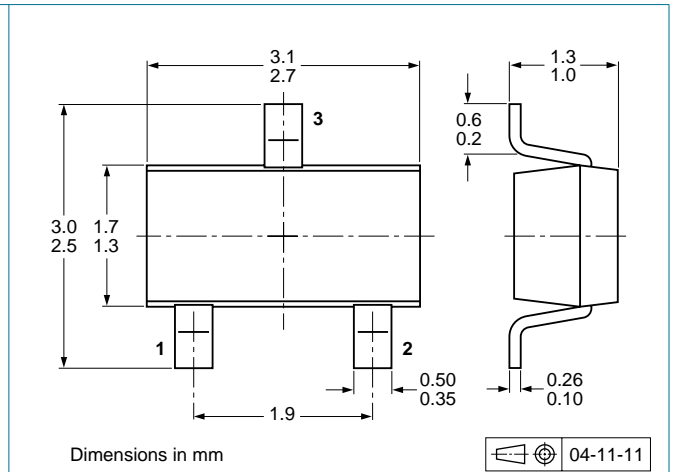

**Fig 4. Package outline SOT346 (SC-59A/TO-236)**

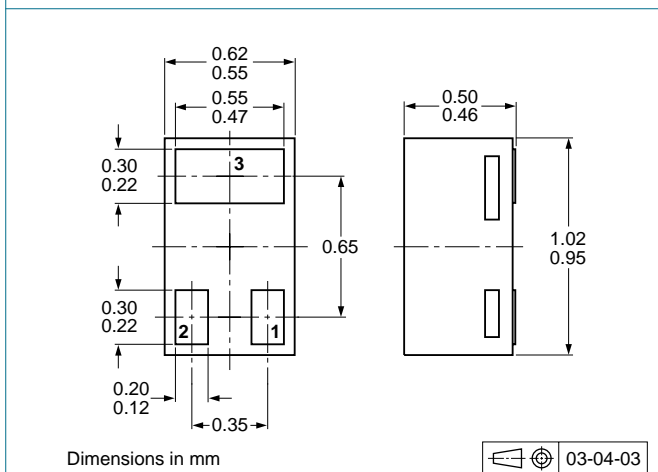

**Fig 5. Package outline SOT883 (SC-101)**

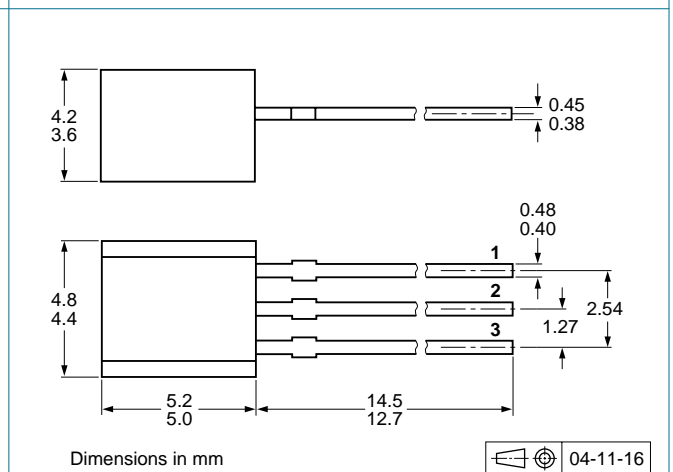

**Fig 6. Package outline SOT54 (SC-43A/TO-92)**

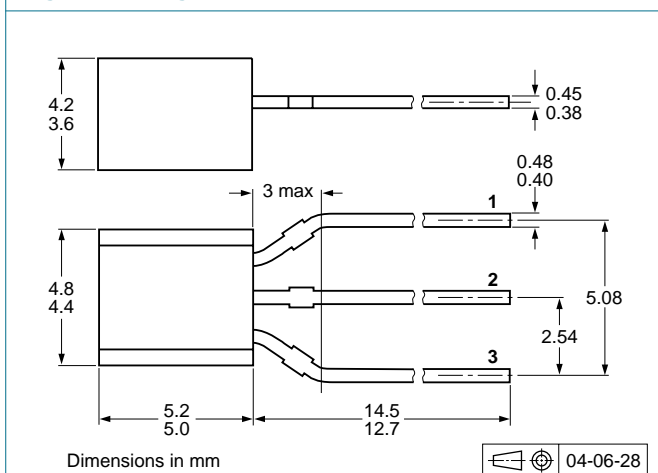

**Fig 7. Package outline SOT54A**

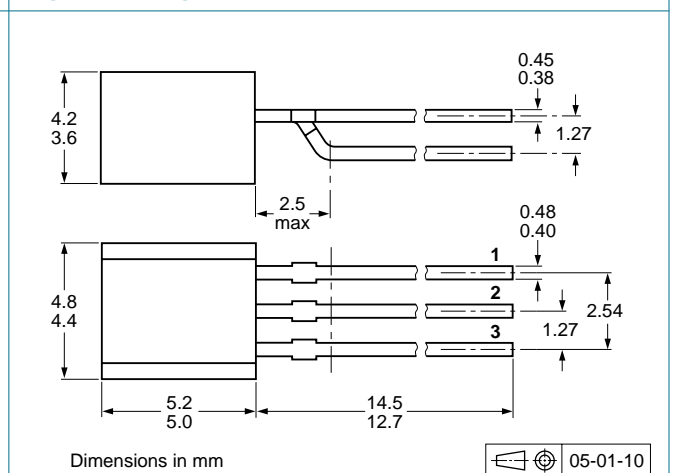

**Fig 8. Package outline SOT54 variant**

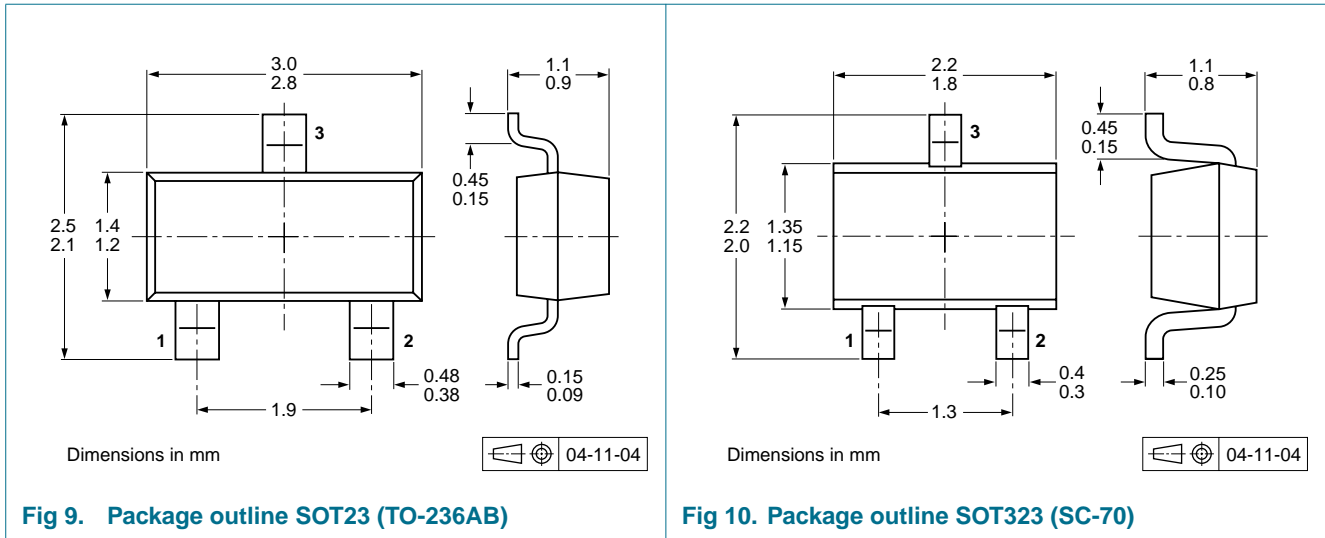

**Fig 9. Package outline SOT23 (TO-236AB)**

**Fig 10. Package outline SOT323 (SC-70)**

## 9. Packing information

**Table 9: Packing methods**

The indicated -xxx are the last three digits of the 12NC ordering code. [1]

Type number	Package	Description	Packing quantity		
			3000	5000	10000
PDTC114TE	SOT416	4 mm pitch, 8 mm tape and reel	-115	-	-135
PDTC114TK	SOT346	4 mm pitch, 8 mm tape and reel	-115	-	-135
PDTC114TM	SOT883	2 mm pitch, 8 mm tape and reel	-	-	-315
PDTC114TS	SOT54	bulk, straight leads	-	-412	-
	SOT54A	tape and reel, wide pitch	-	-	-116
		tape ammpack, wide pitch	-	-	-126
	SOT54 variant	bulk, delta pinning	-	-112	-
PDTC114TT	SOT23	4 mm pitch, 8 mm tape and reel	-215	-	-235
PDTC114TU	SOT323	4 mm pitch, 8 mm tape and reel	-115	-	-135

[1] For further information and the availability of packing methods, see [Section 15](#).

## 10. Revision history

Table 10: Revision history

Document ID	Release date	Data sheet status	Change notice	Doc. number	Supersedes
PDTC114T_SER_8	20060209	Product data sheet	-	-	PDTC114T_SER_7
Modifications:	<ul style="list-style-type: none"> <li>• The format of this data sheet has been redesigned to comply with the new presentation and information standard of Philips Semiconductors.</li> <li>• Type number PDTC114TEF removed</li> <li>• <a href="#">Table 1 “Product overview”</a>: EIAJ in table header amended to JEITA</li> <li>• <a href="#">Section 1.2 “Features”</a>: amended</li> <li>• <a href="#">Section 1.3 “Applications”</a>: amended</li> <li>• <a href="#">Figure 1, 2, 7 and 8</a>: added</li> <li>• <a href="#">Figure 3, 4, 5, 6, 9 and 10</a>: superseded by minimized package outline drawings</li> <li>• <a href="#">Section 9 “Packing information”</a>: added</li> <li>• <a href="#">Section 14 “Trademarks”</a>: added</li> </ul>				
PDTC114T_SER_7	20041011	Product specification	-	9397 750 14186	PDTC114T_SERIES_6
PDTC114T_SERIES_6	20040817	Product specification	-	9397 750 13664	PDTC114T_SERIES_5
PDTC114T_SERIES_5	20040119	Product specification	-	9397 750 11731	PDTC114T_SERIES_4
PDTC114T_SERIES_4	20030414	Product specification	-	9397 750 11011	PDTC114TE_2 PDTC114TK_2 PDTC114TS_2 PDTC114TT_3 PDTC114TU_3
PDTC114TU_3	19990416	Preliminary specification	-	9397 750 05599	PDTC114TU_2
PDTC114TU_2	19980519	Preliminary specification	-	9397 750 03908	PDTC114TU_1
PDTC114TU_1	19970716	Preliminary specification	-	9397 750 01149	-
PDTC114TT_3	19990416	Objective specification	-	9397 750 05598	PDTC114TT_2
PDTC114TT_2	19980519	Objective specification	-	9397 750 03912	PDTC114TT_1
PDTC114TT_1	19970714	Objective specification	-	9397 750 01371	-
PDTC114TS_2	19980518	Product specification	-	9397 750 03891	PDTC114TS_1
PDTC114TS_1	19970703	Product specification	-	9397 750 02297	-
PDTC114TK_2	19980519	Product specification	-	9397 750 03899	PDTC114TK_1

Table 10: Revision history ...continued

Document ID	Release date	Data sheet status	Change notice	Doc. number	Supersedes
PDTC114TK_1	19970528	Product specification	-	9397 750 01367	-
PDTC114TE_2	19980803	Product specification	-	9397 750 04123	PDTC114TE_1
PDTC114TE_1	19970711	Product specification	-	9397 750 02628	-

## 11. Data sheet status

Level	Data sheet status <sup>[1]</sup>	Product status <sup>[2] [3]</sup>	Definition
I	Objective data	Development	This data sheet contains data from the objective specification for product development. Philips Semiconductors reserves the right to change the specification in any manner without notice.
II	Preliminary data	Qualification	This data sheet contains data from the preliminary specification. Supplementary data will be published at a later date. Philips Semiconductors reserves the right to change the specification without notice, in order to improve the design and supply the best possible product.
III	Product data	Production	This data sheet contains data from the product specification. Philips Semiconductors reserves the right to make changes at any time in order to improve the design, manufacturing and supply. Relevant changes will be communicated via a Customer Product/Process Change Notification (CPCN).

[1] Please consult the most recently issued data sheet before initiating or completing a design.

[2] The product status of the device(s) described in this data sheet may have changed since this data sheet was published. The latest information is available on the Internet at URL <http://www.semiconductors.philips.com>.

[3] For data sheets describing multiple type numbers, the highest-level product status determines the data sheet status.

## 12. Definitions

**Short-form specification** — The data in a short-form specification is extracted from a full data sheet with the same type number and title. For detailed information see the relevant data sheet or data handbook.

**Limiting values definition** — Limiting values given are in accordance with the Absolute Maximum Rating System (IEC 60134). Stress above one or more of the limiting values may cause permanent damage to the device. These are stress ratings only and operation of the device at these or at any other conditions above those given in the Characteristics sections of the specification is not implied. Exposure to limiting values for extended periods may affect device reliability.

**Application information** — Applications that are described herein for any of these products are for illustrative purposes only. Philips Semiconductors makes no representation or warranty that such applications will be suitable for the specified use without further testing or modification.

## 13. Disclaimers

**Life support** — These products are not designed for use in life support appliances, devices, or systems where malfunction of these products can reasonably be expected to result in personal injury. Philips Semiconductors

## 15. Contact information

For additional information, please visit: <http://www.semiconductors.philips.com>

For sales office addresses, send an email to: [sales.addresses@www.semiconductors.philips.com](mailto:sales.addresses@www.semiconductors.philips.com)

customers using or selling these products for use in such applications do so at their own risk and agree to fully indemnify Philips Semiconductors for any damages resulting from such application.

**Right to make changes** — Philips Semiconductors reserves the right to make changes in the products - including circuits, standard cells, and/or software - described or contained herein in order to improve design and/or performance. When the product is in full production (status 'Production'), relevant changes will be communicated via a Customer Product/Process Change Notification (CPCN). Philips Semiconductors assumes no responsibility or liability for the use of any of these products, conveys no license or title under any patent, copyright, or mask work right to these products, and makes no representations or warranties that these products are free from patent, copyright, or mask work right infringement, unless otherwise specified.

## 14. Trademarks

**Notice** — All referenced brands, product names, service names and trademarks are the property of their respective owners.



## 16. Contents

---

<b>1</b>	<b>Product profile</b> . . . . .	<b>1</b>
1.1	General description . . . . .	1
1.2	Features . . . . .	1
1.3	Applications . . . . .	1
1.4	Quick reference data . . . . .	1
<b>2</b>	<b>Pinning information</b> . . . . .	<b>2</b>
<b>3</b>	<b>Ordering information</b> . . . . .	<b>3</b>
<b>4</b>	<b>Marking</b> . . . . .	<b>3</b>
<b>5</b>	<b>Limiting values</b> . . . . .	<b>4</b>
<b>6</b>	<b>Thermal characteristics</b> . . . . .	<b>4</b>
<b>7</b>	<b>Characteristics</b> . . . . .	<b>5</b>
<b>8</b>	<b>Package outline</b> . . . . .	<b>6</b>
<b>9</b>	<b>Packing information</b> . . . . .	<b>7</b>
<b>10</b>	<b>Revision history</b> . . . . .	<b>8</b>
<b>11</b>	<b>Data sheet status</b> . . . . .	<b>10</b>
<b>12</b>	<b>Definitions</b> . . . . .	<b>10</b>
<b>13</b>	<b>Disclaimers</b> . . . . .	<b>10</b>
<b>14</b>	<b>Trademarks</b> . . . . .	<b>10</b>
<b>15</b>	<b>Contact information</b> . . . . .	<b>10</b>

## Looking for pricing, stock, or lifecycle information?

Click below to explore more details on WIN SOURCE:

-  [View PDTC114TM,315 on WIN SOURCE](#)
-  [Nexperia USA Inc. Information](#)

## Optimize Your Supply Chain with WIN SOURCE Solutions

-  Global Sourcing Solution
-  Obsolete Management
-  Cost Control Management
-  Shortage Management
-  Alternative Solution
-  Excess Inventory Management