

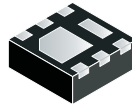

**THE DATASHEET OF
CSD25302Q2**





P-Channel NexFET™ Power MOSFET

FEATURES

- **Ultralow Q_g and Q_{gd}**
- **Low Thermal Resistance**
- **Avalanche Rated**
- **Pb Free Terminal Plating**
- **RoHS Compliant**
- **Halogen Free**
- **SON 2-mm × 2-mm Plastic Package**

APPLICATIONS

- **Battery Management**
- **Load Management**
- **Battery Protection**

DESCRIPTION

The device has been designed to deliver the lowest on resistance and gate charge in the smallest outline possible with excellent thermal characteristics in an ultra low profile. Low on resistance coupled with the extremely small footprint and low profile make the device ideal for battery operated space constrained applications.

Top View

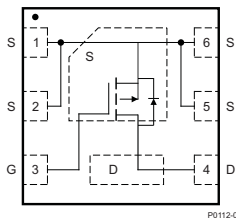

PRODUCT SUMMARY

V_{DS}	Drain to Source Voltage	-20	V	
Q_g	Gate Charge Total (-4.5V)	2.6	nC	
Q_{gd}	Gate Charge Gate to Drain	0.5	nC	
$R_{DS(on)}$	Drain to Source On Resistance	$V_{GS} = -1.8V$	71	m Ω
		$V_{GS} = -2.5V$	56	m Ω
		$V_{GS} = -4.5V$	39	m Ω
$V_{GS(th)}$	Threshold Voltage	-0.65	V	

ORDERING INFORMATION

Device	Package	Media	Qty	Ship
CSD25302Q2	SON 2-mm × 2-mm Plastic Package	13-Inch Reel	3000	Tape and Reel

ABSOLUTE MAXIMUM RATINGS

$T_A = 25^\circ\text{C}$ unless otherwise stated		VALUE	UNIT
V_{DS}	Drain to Source Voltage	-20	V
V_{GS}	Gate to Source Voltage	± 8	V
I_D	Continuous Drain Current, $T_C = 25^\circ\text{C}$	-5	A
	Continuous Drain Current ⁽¹⁾	-5	A
I_{DM}	Pulsed Drain Current, $T_A = 25^\circ\text{C}$ ⁽²⁾	-20	A
P_D	Power Dissipation	2.4	W
T_J, T_{STG}	Operating Junction and Storage Temperature Range	-55 to 150	$^\circ\text{C}$

(1) Package Limited

(2) Pulse duration 10 μs , duty cycle $\leq 2\%$

$R_{DS(on)}$ vs V_{GS}

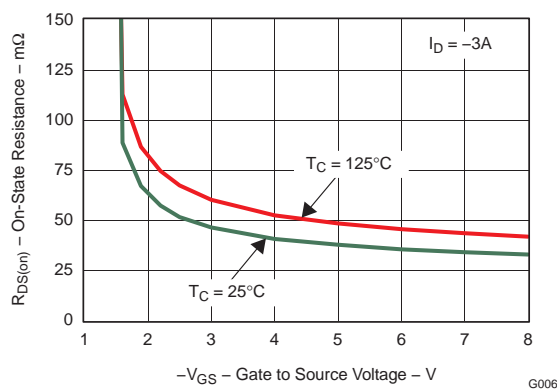

GATE CHARGE

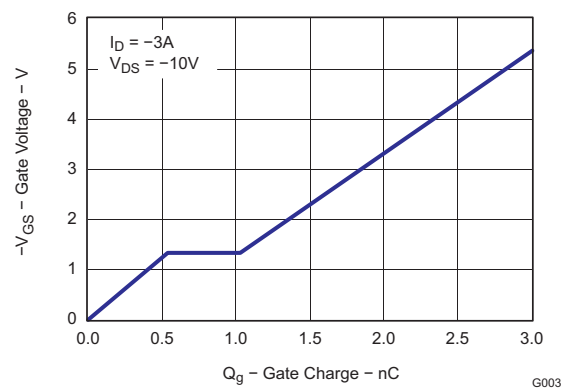

Please be aware that an important notice concerning availability, standard warranty, and use in critical applications of Texas Instruments semiconductor products and disclaimers thereto appears at the end of this data sheet.



These devices have limited built-in ESD protection. The leads should be shorted together or the device placed in conductive foam during storage or handling to prevent electrostatic damage to the MOS gates.

ELECTRICAL CHARACTERISTICS

$T_A = 25^\circ\text{C}$, unless otherwise specified

PARAMETER		TEST CONDITIONS	MIN	TYP	MAX	UNIT
Static Characteristics						
BV_{DSS}	Drain to Source Voltage	$V_{GS} = 0V, I_{DS} = -250\mu A$	-20			V
I_{DSS}	Drain to Source Leakage	$V_{GS} = 0V, V_{DS} = -16V$			-1	μA
I_{GSS}	Gate to Source Leakage	$V_{DS} = 0V, V_{GS} = \pm 8V$			-100	nA
$V_{GS(th)}$	Gate to Source Threshold Voltage	$V_{DS} = V_{GS}, I_{DS} = -250\mu A$	-0.5	-0.65	-0.9	V
$R_{DS(on)}$	Drain to Source On Resistance	$V_{GS} = -1.8V, I_{DS} = -3.0A$		71	92	m Ω
		$V_{GS} = -2.5V, I_{DS} = -3.0A$		56	70	m Ω
		$V_{GS} = -4.5V, I_{DS} = -3.0A$		39	49	m Ω
g_{fs}	Transconductance	$V_{DS} = -10V, I_{DS} = -3.0A$		12.3		S
Dynamic Characteristics						
C_{ISS}	Input Capacitance	$V_{GS} = 0V, V_{DS} = -10V, f = 1MHz$		270	350	pF
C_{OSS}	Output Capacitance			120	150	pF
C_{RSS}	Reverse Transfer Capacitance			40	55	pF
Q_g	Gate Charge Total (-4.5V)	$V_{DS} = -10V, I_{DS} = -3.0A$		2.6	3.4	nC
Q_{gd}	Gate Charge – Gate to Drain			0.5		nC
Q_{gs}	Gate Charge Gate to Source			0.54		nC
$Qg(th)$	Gate Charge at V_{th}			0.2		nC
Q_{OSS}	Output Charge		$V_{DS} = -13V, V_{GS} = 0V$		2.3	
$t_{d(on)}$	Turn On Delay Time	$V_{DS} = -10V, V_{GS} = -4.5V, I_{DS} = -3.0A, R_G = 2\Omega$		3.2		ns
t_r	Rise Time			13.2		ns
$t_{d(off)}$	Turn Off Delay Time			8.6		ns
t_f	Fall Time			1.3		ns
Diode Characteristics						
V_{SD}	Diode Forward Voltage	$I_{DS} = -3.0A, V_{GS} = 0V$	-0.8	-1.0		V
Q_{rr}	Reverse Recovery Charge	$V_{dd} = -13V, I_F = -3.0A, di/dt = 300A/\mu s$		2.5		nC
t_{rr}	Reverse Recovery Time			8.8		ns

THERMAL CHARACTERISTICS

$T_A = 25^\circ\text{C}$, unless otherwise specified

PARAMETER		MIN	TYP	MAX	UNIT
$R_{\theta JC}$	Thermal Resistance Junction to Case ⁽¹⁾			8.6	$^\circ\text{C/W}$
$R_{\theta JA}$	Thermal Resistance Junction to Ambient ⁽¹⁾⁽²⁾			66	$^\circ\text{C/W}$

- $R_{\theta JC}$ is determined with the device mounted on a 1-inch² (6.45-cm²), 2-oz. (0.071-mm thick) Cu pad on a 1.5-inch × 1.5-inch (3.81-cm × 3.81-cm), 0.06-inch (1.52-mm) thick FR4 PCB. $R_{\theta JC}$ is specified by design, whereas $R_{\theta JA}$ is determined by the user's board design.
- Device mounted on FR4 material with 1-inch² (6.45-cm²), 2-oz. (0.071-mm thick) Cu.

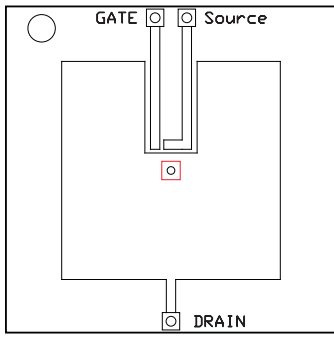

Max $R_{\theta JA} = 66^\circ\text{C/W}$
when mounted on
1 inch² (6.45 cm²) of
2-oz. (0.071-mm thick)
Cu.

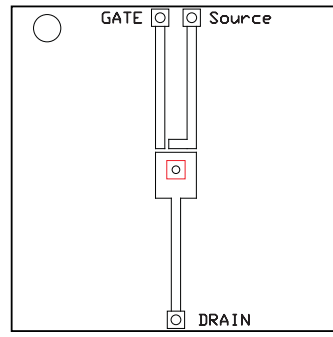

Max $R_{\theta JA} = 207^\circ\text{C/W}$
when mounted on
minimum pad area of
2-oz. (0.071-mm thick)
Cu.

TYPICAL MOSFET CHARACTERISTICS

$T_A = 25^\circ\text{C}$, unless otherwise specified

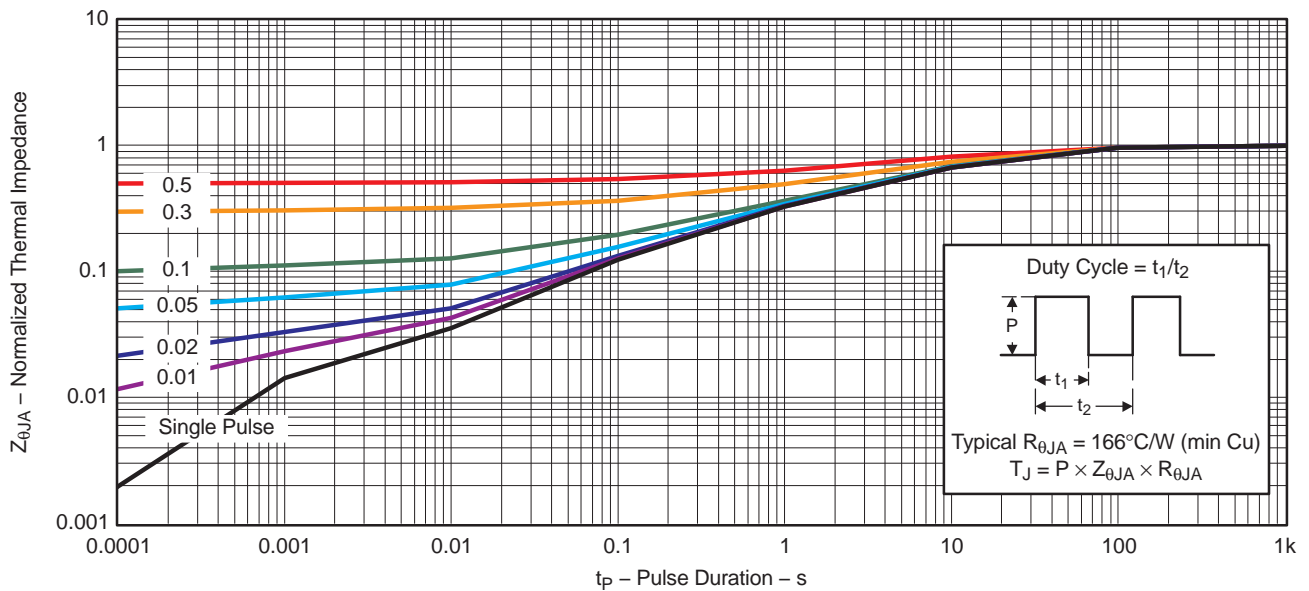

Figure 1. Transient Thermal Impedance

G012

TYPICAL MOSFET CHARACTERISTICS (continued)

$T_A = 25^\circ\text{C}$, unless otherwise specified

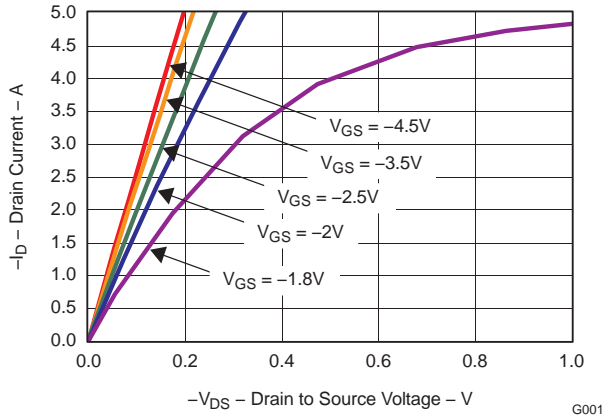

Figure 2. Saturation Characteristics

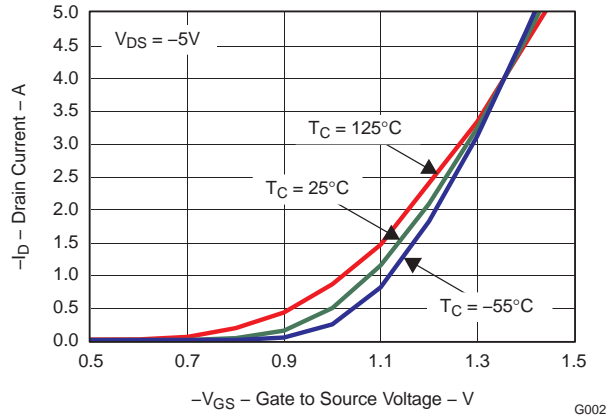

Figure 3. Transfer Characteristics

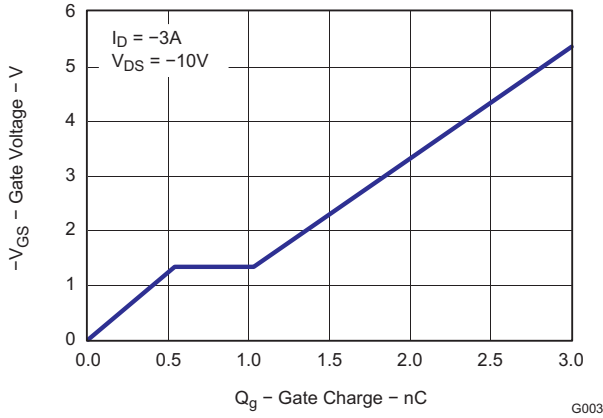

Figure 4. Gate Charge

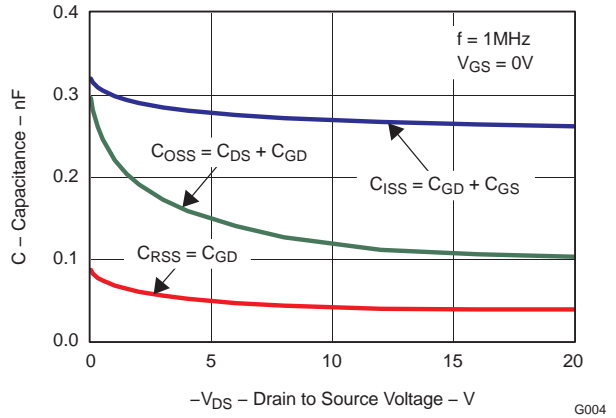

Figure 5. Capacitance

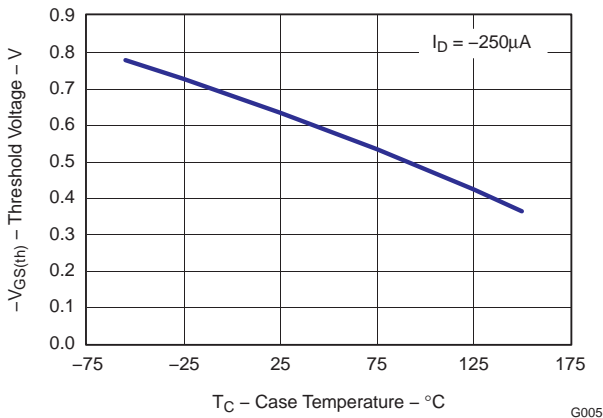

Figure 6. Threshold Voltage vs. Temperature

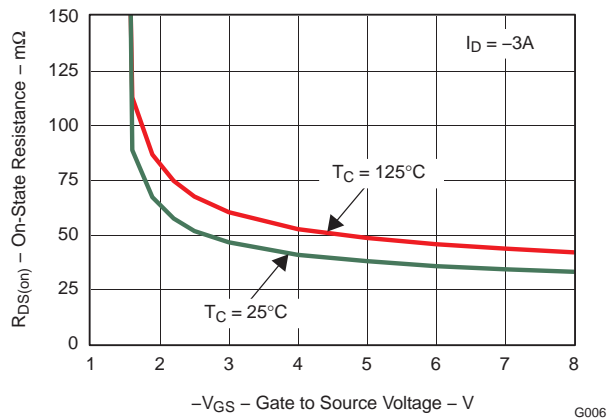

Figure 7. On-State Resistance vs. Gate to Source Voltage

TYPICAL MOSFET CHARACTERISTICS (continued)

T_A = 25°C, unless otherwise specified

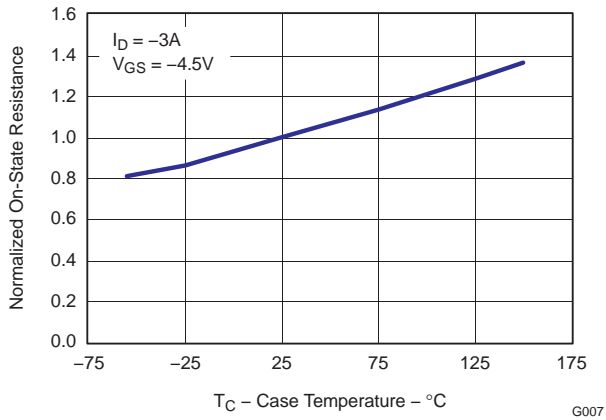

Figure 8. Normalized On-State Resistance vs. Temperature

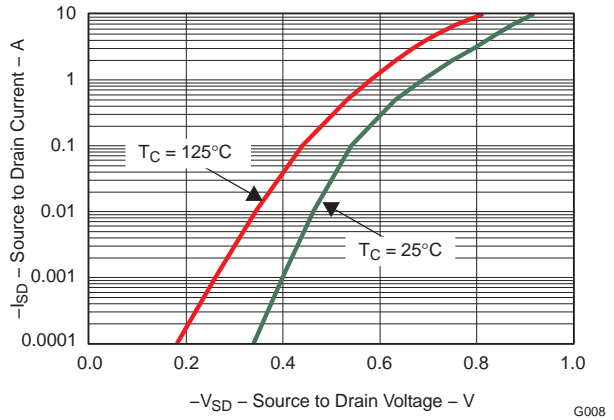

Figure 9. Typical Diode Forward Voltage

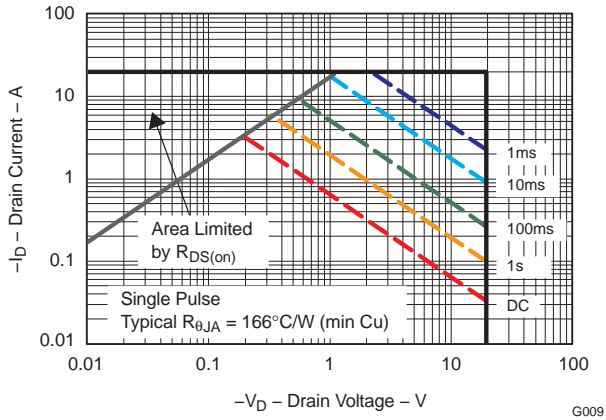

Figure 10. Maximum Safe Operating Area

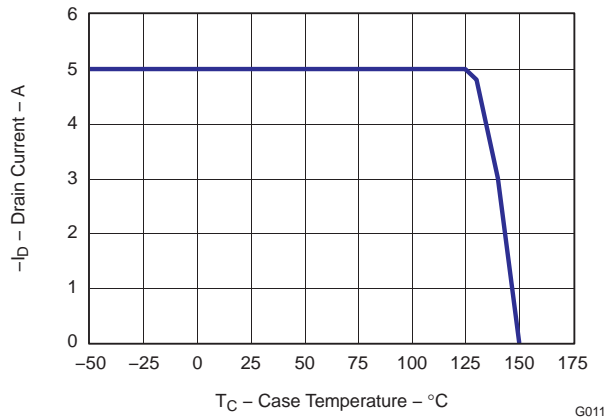
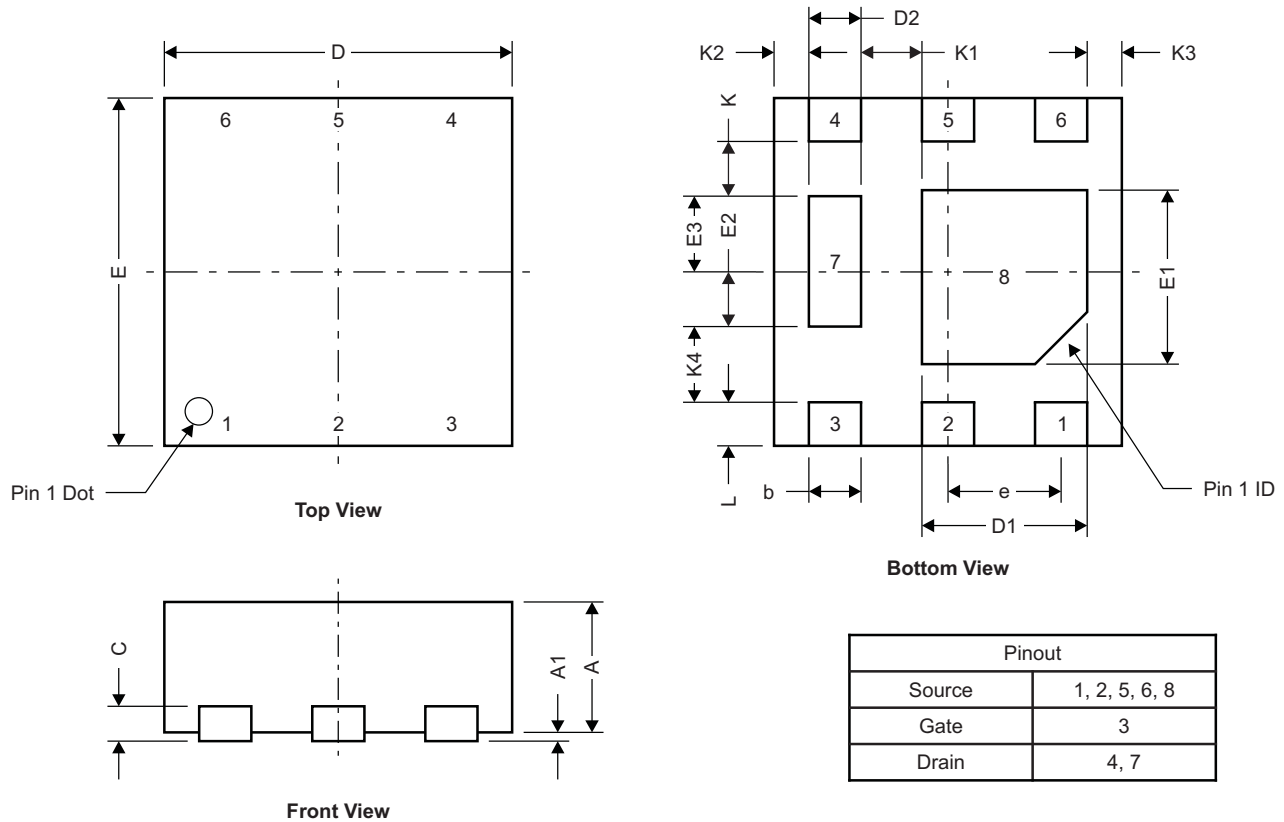

Figure 11. Maximum Drain Current vs. Temperature

MECHANICAL DATA

Q2 Package Dimensions



M0175-01

DIM	MILLIMETERS			INCHES		
	MIN	NOM	MAX	MIN	NOM	MAX
A	0.700	0.750	0.800	0.028	0.030	0.032
A1	0.000		0.050	0.000		0.002
b	0.250	0.300	0.350	0.010	0.012	0.014
C	0.203 TYP			0.008 TYP		
D	2.000 TYP			0.080 TYP		
D1	0.900	0.950	1.000	0.036	0.038	0.040
D2	0.300 TYP			0.012 TYP		
E	2.000 TYP			0.080 TYP		
E1	0.900	1.000	1.100	0.036	0.040	0.044
E2	0.280 TYP			0.0112 TYP		
E3	0.470 TYP			0.0188 TYP		
e	0.650 BSC			0.026 TYP		
K	0.280 TYP			0.0112 TYP		
K1	0.350 TYP			0.014 TYP		
K2	0.200 TYP			0.008 TYP		
K3	0.200 TYP			0.008 TYP		
K4	0.470 TYP			0.0188 TYP		
L	0.200	0.25	0.300	0.008	0.010	0.0121

Recommended PCB Pattern

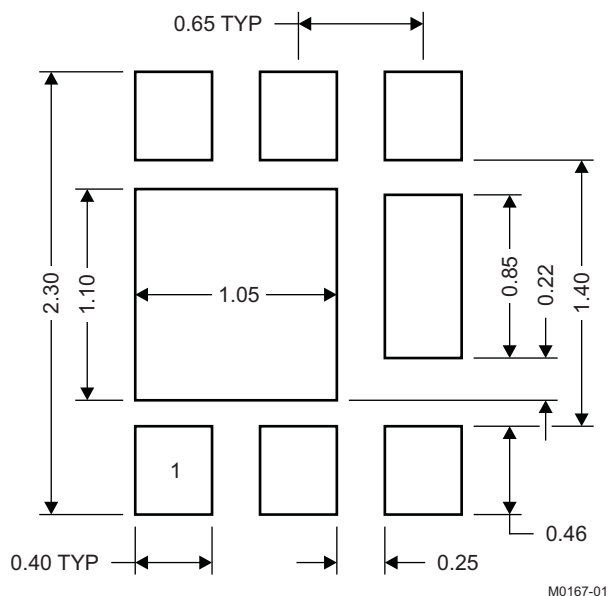

Note: All dimensions are in mm, unless otherwise specified.

For recommended circuit layout for PCB designs, see application note [SLPA005 – Reducing Ringing through PCB Layout Techniques](#).

Q2 Tape and Reel Information

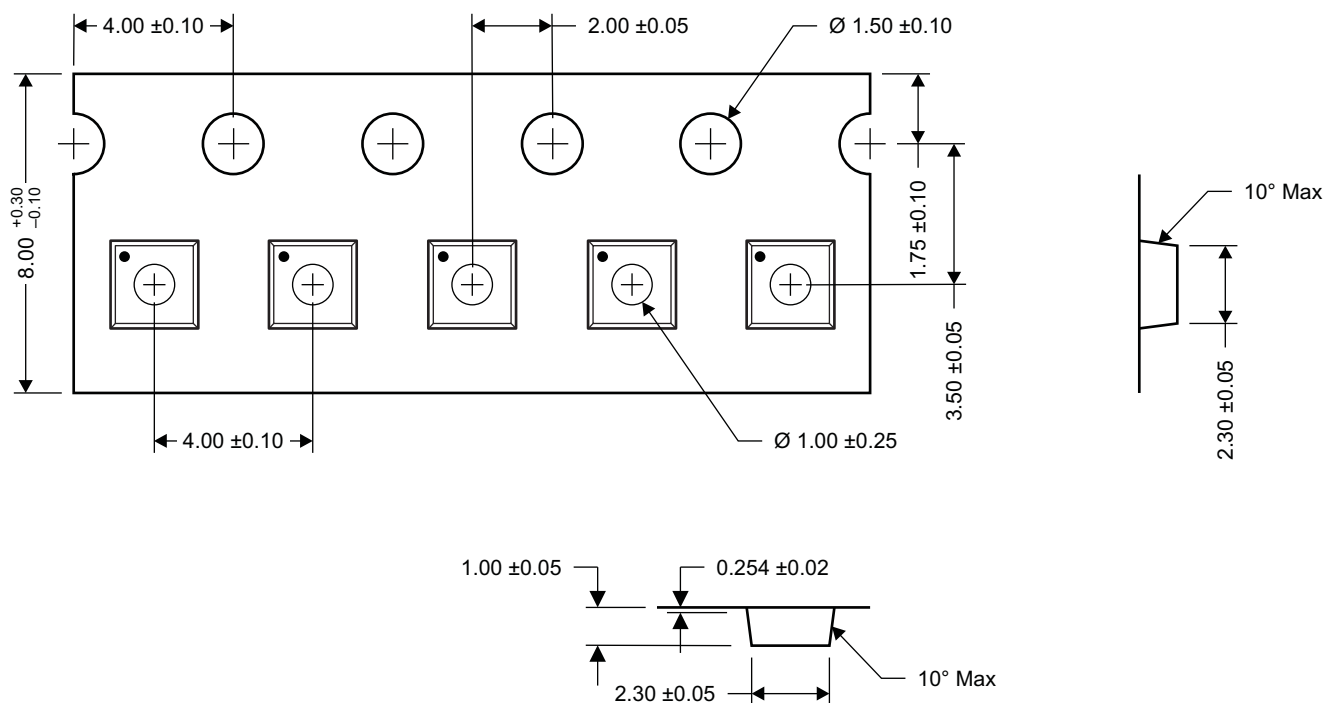

- Notes:
1. Measured from centerline of sprocket hole to centerline of pocket
 2. Cumulative tolerance of 10 sprocket holes is ± 0.20
 3. Other material available
 4. Typical SR of form tape Max 10^8 OHM/SQ
 5. All dimensions are in mm, unless otherwise specified.

REVISION HISTORY

Changes from Original (November 2009) to Revision A **Page**

- Deleted the Package Marking Information section **8**
-

Changes from Revision A (October 2010) to Revision B **Page**

- Added ESDS statement **2**
-

IMPORTANT NOTICE

Texas Instruments Incorporated and its subsidiaries (TI) reserve the right to make corrections, modifications, enhancements, improvements, and other changes to its products and services at any time and to discontinue any product or service without notice. Customers should obtain the latest relevant information before placing orders and should verify that such information is current and complete. All products are sold subject to TI's terms and conditions of sale supplied at the time of order acknowledgment.

TI warrants performance of its hardware products to the specifications applicable at the time of sale in accordance with TI's standard warranty. Testing and other quality control techniques are used to the extent TI deems necessary to support this warranty. Except where mandated by government requirements, testing of all parameters of each product is not necessarily performed.

TI assumes no liability for applications assistance or customer product design. Customers are responsible for their products and applications using TI components. To minimize the risks associated with customer products and applications, customers should provide adequate design and operating safeguards.

TI does not warrant or represent that any license, either express or implied, is granted under any TI patent right, copyright, mask work right, or other TI intellectual property right relating to any combination, machine, or process in which TI products or services are used. Information published by TI regarding third-party products or services does not constitute a license from TI to use such products or services or a warranty or endorsement thereof. Use of such information may require a license from a third party under the patents or other intellectual property of the third party, or a license from TI under the patents or other intellectual property of TI.

Reproduction of TI information in TI data books or data sheets is permissible only if reproduction is without alteration and is accompanied by all associated warranties, conditions, limitations, and notices. Reproduction of this information with alteration is an unfair and deceptive business practice. TI is not responsible or liable for such altered documentation. Information of third parties may be subject to additional restrictions.

Resale of TI products or services with statements different from or beyond the parameters stated by TI for that product or service voids all express and any implied warranties for the associated TI product or service and is an unfair and deceptive business practice. TI is not responsible or liable for any such statements.

TI products are not authorized for use in safety-critical applications (such as life support) where a failure of the TI product would reasonably be expected to cause severe personal injury or death, unless officers of the parties have executed an agreement specifically governing such use. Buyers represent that they have all necessary expertise in the safety and regulatory ramifications of their applications, and acknowledge and agree that they are solely responsible for all legal, regulatory and safety-related requirements concerning their products and any use of TI products in such safety-critical applications, notwithstanding any applications-related information or support that may be provided by TI. Further, Buyers must fully indemnify TI and its representatives against any damages arising out of the use of TI products in such safety-critical applications.

TI products are neither designed nor intended for use in military/aerospace applications or environments unless the TI products are specifically designated by TI as military-grade or "enhanced plastic." Only products designated by TI as military-grade meet military specifications. Buyers acknowledge and agree that any such use of TI products which TI has not designated as military-grade is solely at the Buyer's risk, and that they are solely responsible for compliance with all legal and regulatory requirements in connection with such use.

TI products are neither designed nor intended for use in automotive applications or environments unless the specific TI products are designated by TI as compliant with ISO/TS 16949 requirements. Buyers acknowledge and agree that, if they use any non-designated products in automotive applications, TI will not be responsible for any failure to meet such requirements.

Following are URLs where you can obtain information on other Texas Instruments products and application solutions:

Products

Audio	www.ti.com/audio
Amplifiers	amplifier.ti.com
Data Converters	dataconverter.ti.com
DLP® Products	www.dlp.com
DSP	dsp.ti.com
Clocks and Timers	www.ti.com/clocks
Interface	interface.ti.com
Logic	logic.ti.com
Power Mgmt	power.ti.com
Microcontrollers	microcontroller.ti.com
RFID	www.ti-rfid.com
OMAP Mobile Processors	www.ti.com/omap
Wireless Connectivity	www.ti.com/wirelessconnectivity

Applications

Automotive and Transportation	www.ti.com/automotive
Communications and Telecom	www.ti.com/communications
Computers and Peripherals	www.ti.com/computers
Consumer Electronics	www.ti.com/consumer-apps
Energy and Lighting	www.ti.com/energy
Industrial	www.ti.com/industrial
Medical	www.ti.com/medical
Security	www.ti.com/security
Space, Avionics and Defense	www.ti.com/space-avionics-defense
Video and Imaging	www.ti.com/video

TI E2E Community Home Page

e2e.ti.com

Mailing Address: Texas Instruments, Post Office Box 655303, Dallas, Texas 75265
Copyright © 2012, Texas Instruments Incorporated

Looking for pricing, stock, or lifecycle information?

Click below to explore more details on WIN SOURCE:

 [View CSD25302Q2](#) on WIN SOURCE

 [Texas Instruments](#) Information

Optimize Your Supply Chain with WIN SOURCE Solutions

-  Global Sourcing Solution
-  Obsolete Management
-  Cost Control Management
-  Shortage Management
-  Alternative Solution
-  Excess Inventory Management