



**THE DATASHEET OF  
PBSS4032PD,115**



## Important notice

Dear Customer,

On 7 February 2017 the former NXP Standard Product business became a new company with the tradename **Nexperia**. Nexperia is an industry leading supplier of Discrete, Logic and PowerMOS semiconductors with its focus on the automotive, industrial, computing, consumer and wearable application markets

In data sheets and application notes which still contain NXP or Philips Semiconductors references, use the references to Nexperia, as shown below.

Instead of <http://www.nxp.com>, <http://www.philips.com/> or <http://www.semiconductors.philips.com/>, use <http://www.nexperia.com>

Instead of [sales.addresses@www.nxp.com](mailto:sales.addresses@www.nxp.com) or [sales.addresses@www.semiconductors.philips.com](mailto:sales.addresses@www.semiconductors.philips.com), use [salesaddresses@nexperia.com](mailto:salesaddresses@nexperia.com) (email)

Replace the copyright notice at the bottom of each page or elsewhere in the document, depending on the version, as shown below:

- © NXP N.V. (year). All rights reserved or © Koninklijke Philips Electronics N.V. (year). All rights reserved

Should be replaced with:

- © **Nexperia B.V. (year). All rights reserved.**

If you have any questions related to the data sheet, please contact our nearest sales office via e-mail or telephone (details via [salesaddresses@nexperia.com](mailto:salesaddresses@nexperia.com)). Thank you for your cooperation and understanding,

Kind regards,

Team Nexperia

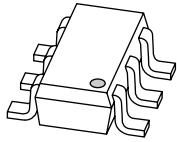

# PBSS4032PD

30 V, 2.7 A PNP low  $V_{CEsat}$  (BISS) transistor

Rev. 01 — 27 January 2010

Product data sheet

## 1. Product profile

### 1.1 General description

PNP low  $V_{CEsat}$  Breakthrough In Small Signal (BISS) transistor in a SOT457 (SC-74) small Surface-Mounted Device (SMD) plastic package.

NPN complement: PBSS4032ND.

### 1.2 Features

- Low collector-emitter saturation voltage  $V_{CEsat}$
- Optimized switching time
- High collector current capability  $I_C$  and  $I_{CM}$
- High collector current gain ( $h_{FE}$ ) at high  $I_C$
- High energy efficiency due to less heat generation
- AEC-Q101 qualified
- Smaller required Printed-Circuit Board (PCB) area than for conventional transistors

### 1.3 Applications

- DC-to-DC conversion
- Battery-driven devices
- Power management
- Charging circuits

### 1.4 Quick reference data

Table 1. Quick reference data

| Symbol      | Parameter                                  | Conditions                       | Min   | Typ | Max  | Unit       |
|-------------|--|----------------------------------|-------|-----|------|------------|
| $V_{CEO}$   | collector-emitter voltage                  | open base                        | -     | -   | -30  | V          |
| $I_C$       | collector current                          |                                  | -     | -   | -2.7 | A          |
| $I_{CM}$    | peak collector current                     | single pulse;<br>$t_p \leq 1$ ms | -     | -   | -5   | A          |
| $R_{CEsat}$ | collector-emitter<br>saturation resistance | $I_C = -3$ A;<br>$I_B = -300$ mA | [1] - | 88  | 130  | m $\Omega$ |

[1] Pulse test:  $t_p \leq 300$   $\mu$ s;  $\delta \leq 0.02$ .

## 2. Pinning information

Table 2. Pinning

| Pin | Description | Simplified outline | Graphic symbol                            |
|-----|-------------|--------------------|---|
| 1   | collector   |                    | <p style="text-align: center;">sym030</p> |
| 2   | collector   |                    |   |
| 3   | base        |                    |   |
| 4   | emitter     |                    |   |
| 5   | collector   |                    |   |
| 6   | collector   |                    |   |

## 3. Ordering information

Table 3. Ordering information

| Type number | Package |  |         |
|-------------|---------|--|---------|
|             | Name    | Description                              | Version |
| PBSS4032PD  | SC-74   | plastic surface-mounted package; 6 leads | SOT457  |

## 4. Marking

Table 4. Marking codes

| Type number | Marking code |
|-------------|--------------|
| PBSS4032PD  | ZG           |

## 5. Limiting values

Table 5. Limiting values

In accordance with the Absolute Maximum Rating System (IEC 60134).

| Symbol    | Parameter                 | Conditions                       | Min | Max  | Unit |
|-----------|---------------------------|----------------------------------|-----|------|------|
| $V_{CBO}$ | collector-base voltage    | open emitter                     | -   | -30  | V    |
| $V_{CEO}$ | collector-emitter voltage | open base                        | -   | -30  | V    |
| $V_{EBO}$ | emitter-base voltage      | open collector                   | -   | -5   | V    |
| $I_C$     | collector current         |                                  | -   | -2.7 | A    |
| $I_{CM}$  | peak collector current    | single pulse;<br>$t_p \leq 1$ ms | -   | -5   | A    |
| $I_B$     | base current              |                                  | -   | -0.5 | A    |

**Table 5. Limiting values ...continued**

In accordance with the Absolute Maximum Rating System (IEC 60134).

| Symbol    | Parameter               | Conditions                  | Min   | Max  | Unit |
|-----------|-------------------------|-----------------------------|-------|------|------|
| $P_{tot}$ | total power dissipation | $T_{amb} \leq 25\text{ °C}$ | [1] - | 480  | mW   |
|           |                         |                             | [2] - | 750  | mW   |
|           |                         |                             | [3] - | 1    | W    |
| $T_j$     | junction temperature    |                             | -     | 150  | °C   |
| $T_{amb}$ | ambient temperature     |                             | -55   | +150 | °C   |
| $T_{stg}$ | storage temperature     |                             | -65   | +150 | °C   |

- [1] Device mounted on an FR4 PCB, single-sided copper, tin-plated and standard footprint.
- [2] Device mounted on an FR4 PCB, single-sided copper, tin-plated, mounting pad for collector 6 cm<sup>2</sup>.
- [3] Device mounted on a ceramic PCB, Al<sub>2</sub>O<sub>3</sub>, standard footprint.

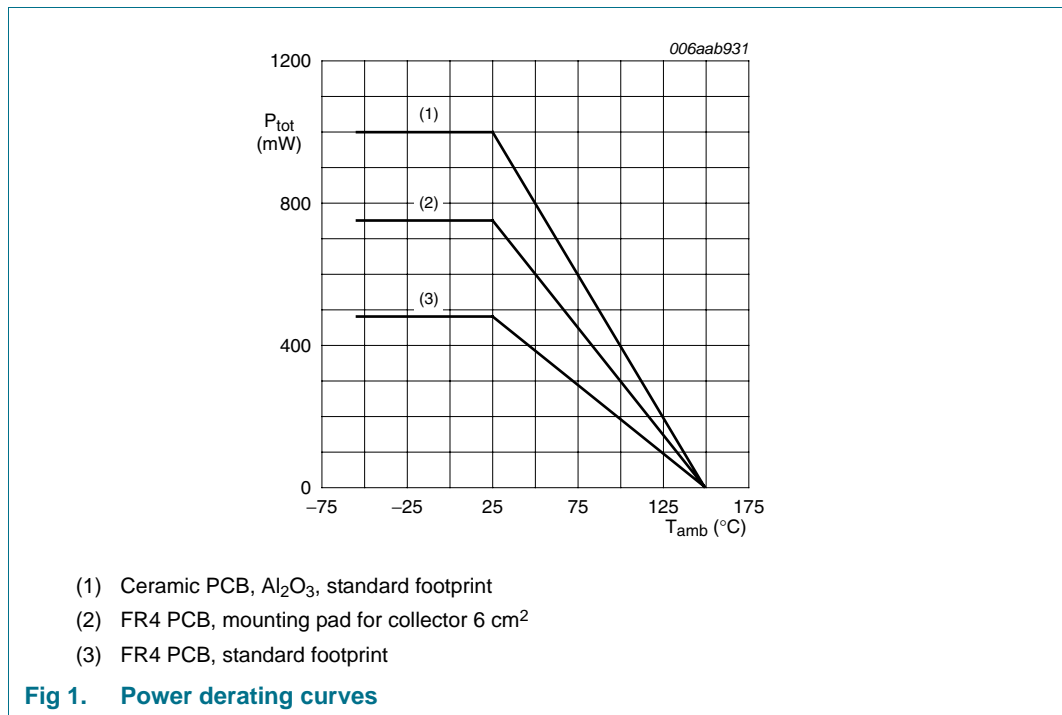

## 6. Thermal characteristics

**Table 6. Thermal characteristics**

| Symbol         | Parameter  | Conditions  | Min | Typ | Max | Unit |     |
|----------------|--|-------------|-----|-----|-----|------|-----|
| $R_{th(j-a)}$  | thermal resistance from junction to ambient      | in free air | [1] | -   | -   | 260  | K/W |
|                |  |             | [2] | -   | -   | 160  | K/W |
|                |  |             | [3] | -   | -   | 125  | K/W |
| $R_{th(j-sp)}$ | thermal resistance from junction to solder point |             | -   | -   | 45  | K/W  |     |

- [1] Device mounted on an FR4 PCB, single-sided copper, tin-plated and standard footprint.
- [2] Device mounted on an FR4 PCB, single-sided copper, tin-plated, mounting pad for collector 6 cm<sup>2</sup>.
- [3] Device mounted on a ceramic PCB, Al<sub>2</sub>O<sub>3</sub>, standard footprint.

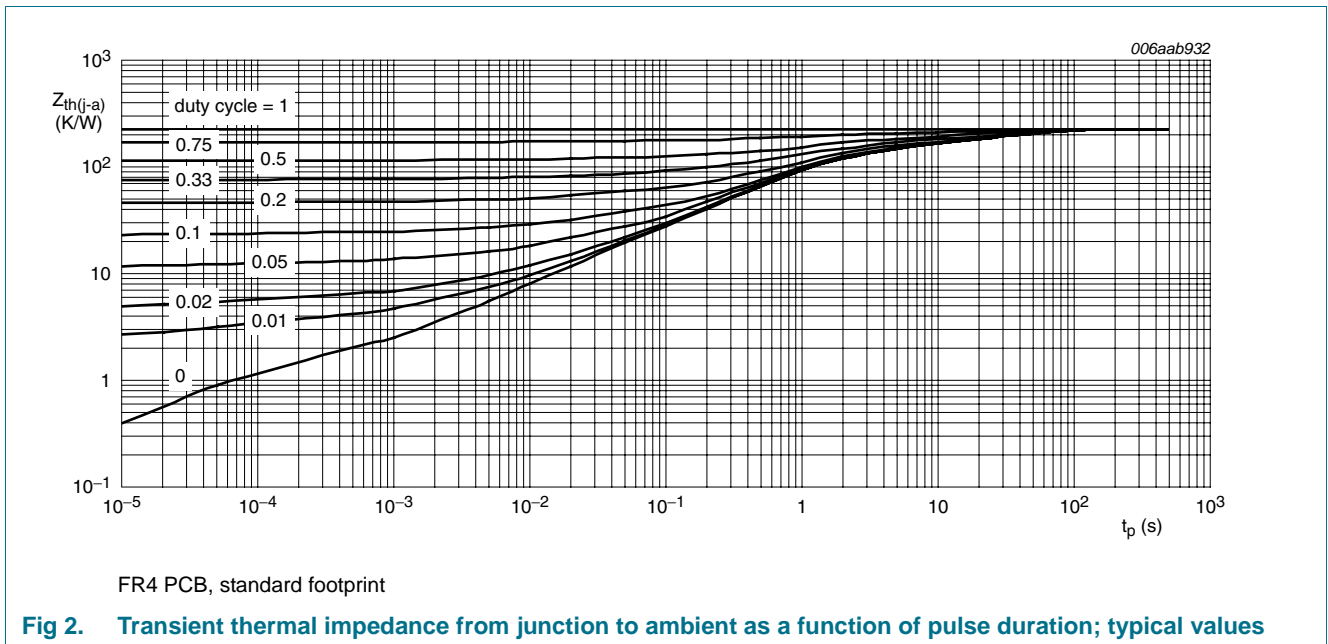

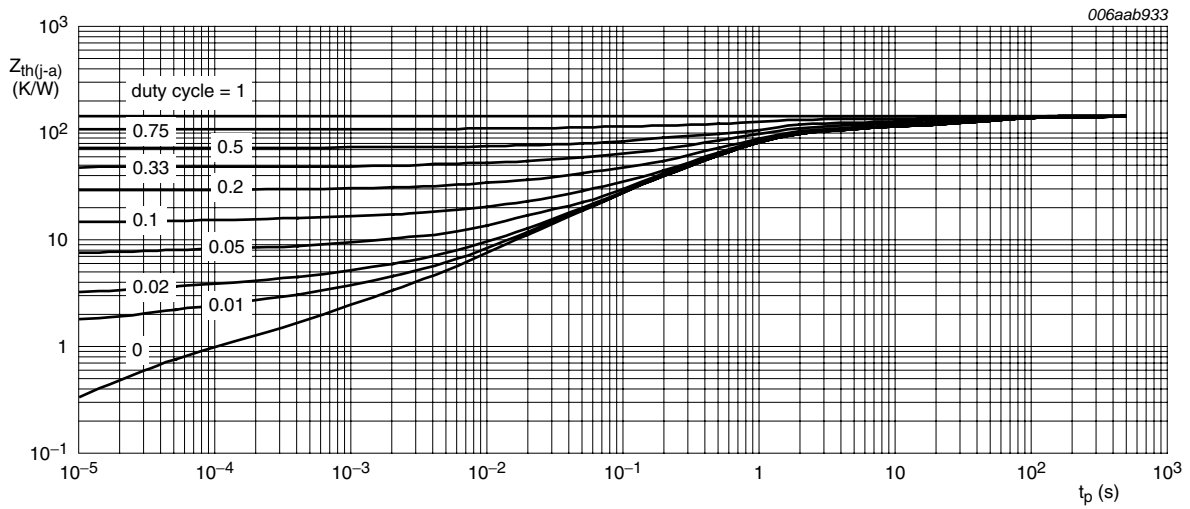

FR4 PCB, mounting pad for collector 6 cm<sup>2</sup>

Fig 3. Transient thermal impedance from junction to ambient as a function of pulse duration; typical values

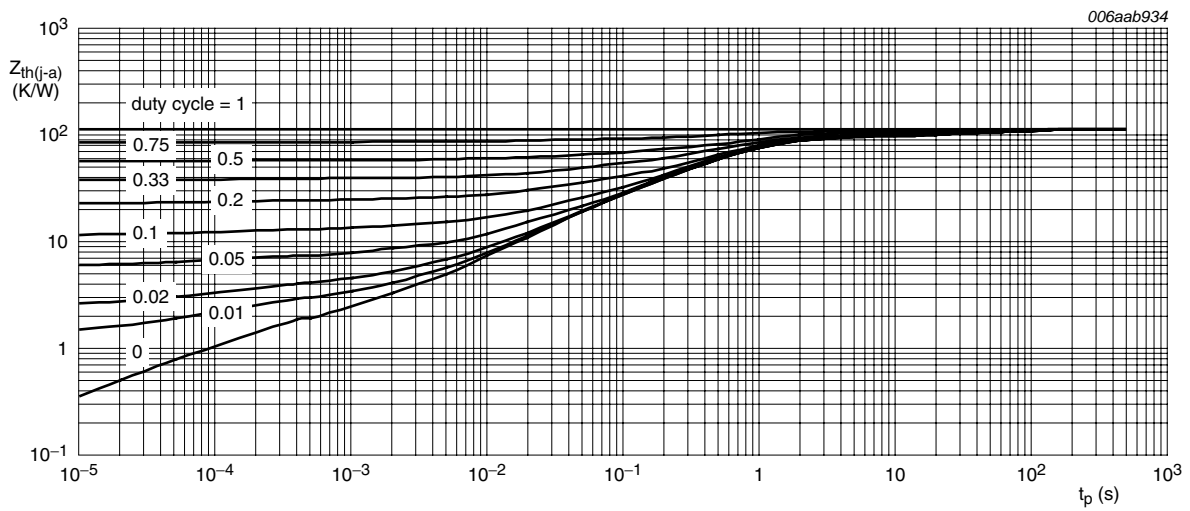

Ceramic PCB, Al<sub>2</sub>O<sub>3</sub>, standard footprint

Fig 4. Transient thermal impedance from junction to ambient as a function of pulse duration; typical values

## 7. Characteristics

**Table 7. Characteristics**
 $T_{amb} = 25\text{ }^{\circ}\text{C}$  unless otherwise specified.

| Symbol      | Parameter                               | Conditions   | Min | Typ   | Max   | Unit          |                  |
|-------------|---|--|-----|-------|-------|---------------|------------------|
| $I_{CBO}$   | collector-base cut-off current          | $V_{CB} = -30\text{ V}; I_E = 0\text{ A}$  | -   | -     | -100  | nA            |                  |
|             |   | $V_{CB} = -30\text{ V}; I_E = 0\text{ A}; T_j = 150\text{ }^{\circ}\text{C}$                     | -   | -     | -55   | $\mu\text{A}$ |                  |
| $I_{CES}$   | collector-emitter cut-off current       | $V_{CE} = -24\text{ V}; V_{BE} = 0\text{ V}$   | -   | -     | -100  | nA            |                  |
| $I_{EBO}$   | emitter-base cut-off current            | $V_{EB} = -5\text{ V}; I_C = 0\text{ A}$   | -   | -     | -100  | nA            |                  |
| $h_{FE}$    | DC current gain                         | $V_{CE} = -2\text{ V}; I_C = -500\text{ mA}$   | [1] | 200   | 350   | -             |                  |
|             |   | $V_{CE} = -2\text{ V}; I_C = -1\text{ A}$  | [1] | 200   | 300   | -             |                  |
|             |   | $V_{CE} = -2\text{ V}; I_C = -2\text{ A}$  | [1] | 100   | 160   | -             |                  |
|             |   | $V_{CE} = -2\text{ V}; I_C = -4\text{ A}$  | [1] | 25    | 40    | -             |                  |
| $V_{CEsat}$ | collector-emitter saturation voltage    | $I_C = -500\text{ mA}; I_B = -50\text{ mA}$  | -   | -87   | -130  | mV            |                  |
|             |   | $I_C = -1\text{ A}; I_B = -50\text{ mA}$   | [1] | -     | -140  | -210          | mV               |
|             |   | $I_C = -1\text{ A}; I_B = -10\text{ mA}$   | [1] | -     | -205  | -300          | mV               |
|             |   | $I_C = -2\text{ A}; I_B = -40\text{ mA}$   | [1] | -     | -280  | -420          | mV               |
|             |   | $I_C = -2\text{ A}; I_B = -200\text{ mA}$  | [1] | -     | -170  | -255          | mV               |
| $R_{CEsat}$ | collector-emitter saturation resistance | $I_C = -3\text{ A}; I_B = -300\text{ mA}$  | [1] | -     | 88    | 130           | $\text{m}\Omega$ |
|             |   |  |     |       |       |               |                  |
| $V_{BEsat}$ | base-emitter saturation voltage         | $I_C = -1\text{ A}; I_B = -100\text{ mA}$  | [1] | -     | -0.83 | -0.9          | V                |
|             |   | $I_C = -3\text{ A}; I_B = -300\text{ mA}$  | [1] | -     | -1.11 | -1.2          | V                |
| $V_{BEon}$  | base-emitter turn-on voltage            | $V_{CE} = -2\text{ V}; I_C = -2\text{ A}$  | -   | -0.85 | -0.95 | V             |                  |
| $t_d$       | delay time                              | $V_{CC} = -12.5\text{ V}; I_C = -1\text{ A}; I_{Bon} = -0.05\text{ A}; I_{Boff} = 0.05\text{ A}$ | -   | 20    | -     | ns            |                  |
| $t_r$       | rise time                               |  | -   | 55    | -     | ns            |                  |
| $t_{on}$    | turn-on time                            |  | -   | 75    | -     | ns            |                  |
| $t_s$       | storage time                            |  | -   | 130   | -     | ns            |                  |
| $t_f$       | fall time                               |  | -   | 80    | -     | ns            |                  |
| $t_{off}$   | turn-off time                           |  | -   | 210   | -     | ns            |                  |
| $f_T$       | transition frequency                    | $V_{CE} = -10\text{ V}; I_C = -100\text{ mA}; f = 100\text{ MHz}$                                | -   | 104   | -     | MHz           |                  |
| $C_c$       | collector capacitance                   | $V_{CB} = -10\text{ V}; I_E = I_e = 0\text{ A}; f = 1\text{ MHz}$                                | -   | 59    | -     | pF            |                  |

[1] Pulse test:  $t_p \leq 300\text{ }\mu\text{s}; \delta \leq 0.02$ .

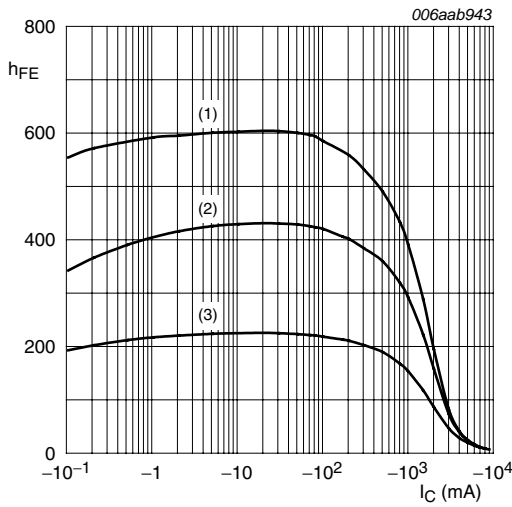

$V_{CE} = -2\text{ V}$   
 (1)  $T_{amb} = 100\text{ }^\circ\text{C}$   
 (2)  $T_{amb} = 25\text{ }^\circ\text{C}$   
 (3)  $T_{amb} = -55\text{ }^\circ\text{C}$

**Fig 5. DC current gain as a function of collector current; typical values**

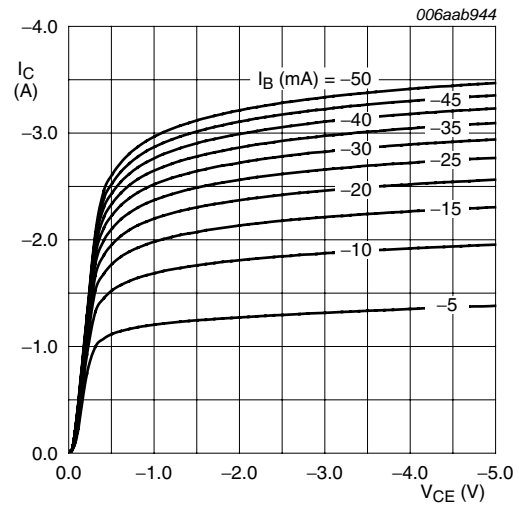

$T_{amb} = 25\text{ }^\circ\text{C}$

**Fig 6. Collector current as a function of collector-emitter voltage; typical values**

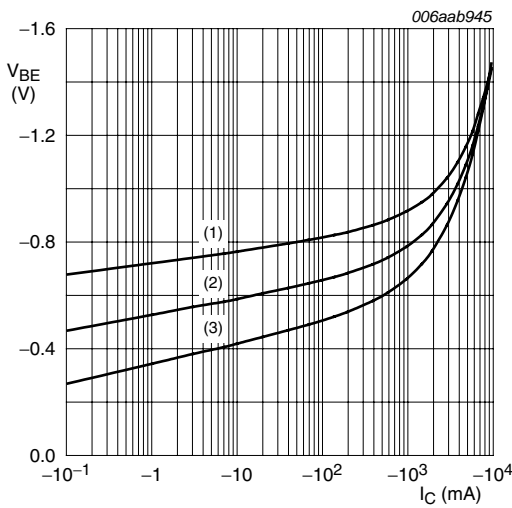

$V_{CE} = -2\text{ V}$   
 (1)  $T_{amb} = -55\text{ }^\circ\text{C}$   
 (2)  $T_{amb} = 25\text{ }^\circ\text{C}$   
 (3)  $T_{amb} = 100\text{ }^\circ\text{C}$

**Fig 7. Base-emitter voltage as a function of collector current; typical values**

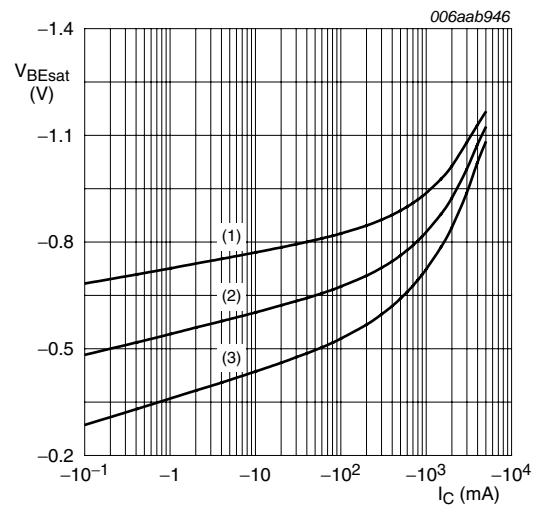

$I_C/I_B = 20$   
 (1)  $T_{amb} = -55\text{ }^\circ\text{C}$   
 (2)  $T_{amb} = 25\text{ }^\circ\text{C}$   
 (3)  $T_{amb} = 100\text{ }^\circ\text{C}$

**Fig 8. Base-emitter saturation voltage as a function of collector current; typical values**

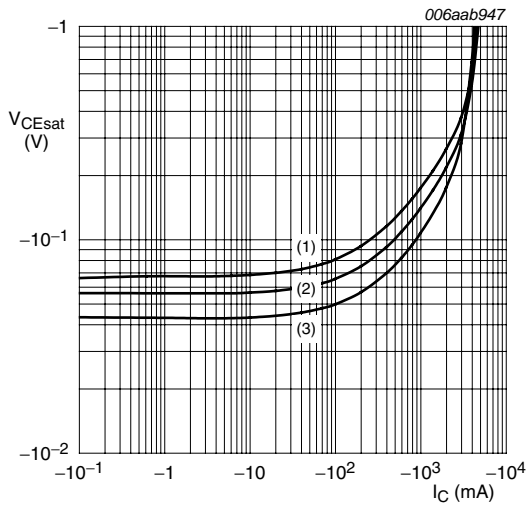

$I_C/I_B = 20$   
 (1)  $T_{amb} = 100\text{ °C}$   
 (2)  $T_{amb} = 25\text{ °C}$   
 (3)  $T_{amb} = -55\text{ °C}$

**Fig 9. Collector-emitter saturation voltage as a function of collector current; typical values**

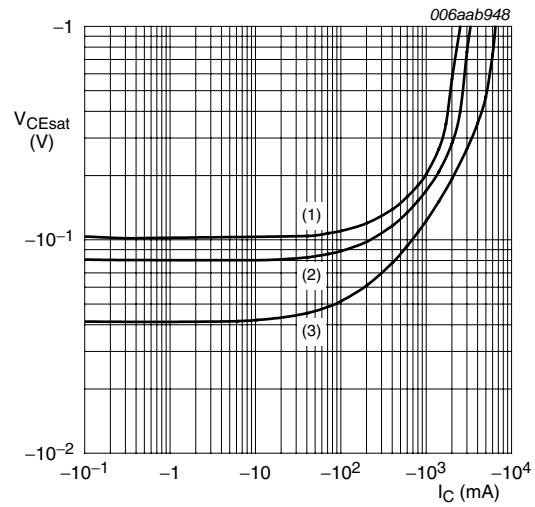

$T_{amb} = 25\text{ °C}$   
 (1)  $I_C/I_B = 100$   
 (2)  $I_C/I_B = 50$   
 (3)  $I_C/I_B = 10$

**Fig 10. Collector-emitter saturation voltage as a function of collector current; typical values**

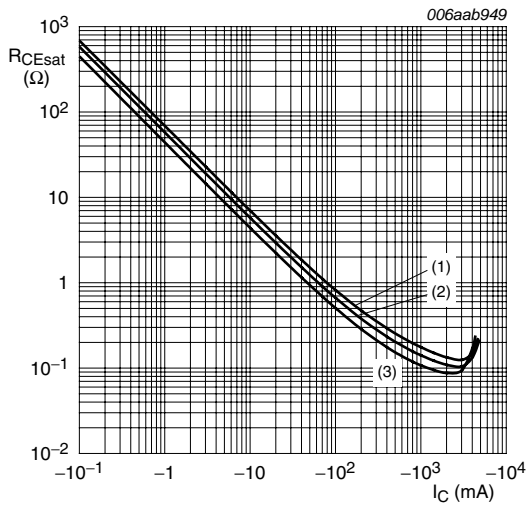

$I_C/I_B = 20$   
 (1)  $T_{amb} = 100\text{ °C}$   
 (2)  $T_{amb} = 25\text{ °C}$   
 (3)  $T_{amb} = -55\text{ °C}$

**Fig 11. Collector-emitter saturation resistance as a function of collector current; typical values**

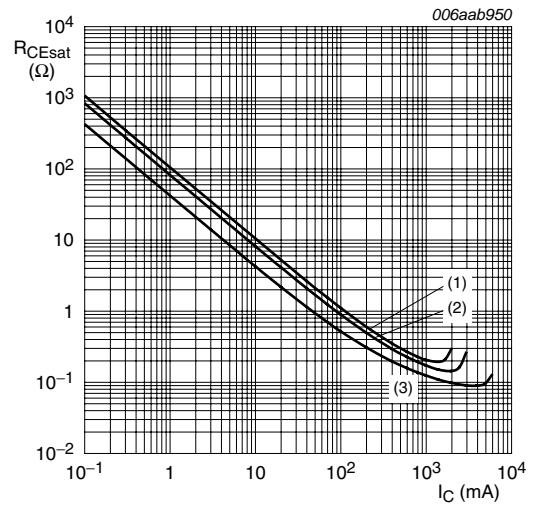

$T_{amb} = 25\text{ °C}$   
 (1)  $I_C/I_B = 100$   
 (2)  $I_C/I_B = 50$   
 (3)  $I_C/I_B = 10$

**Fig 12. Collector-emitter saturation resistance as a function of collector current; typical values**

**8. Test information**

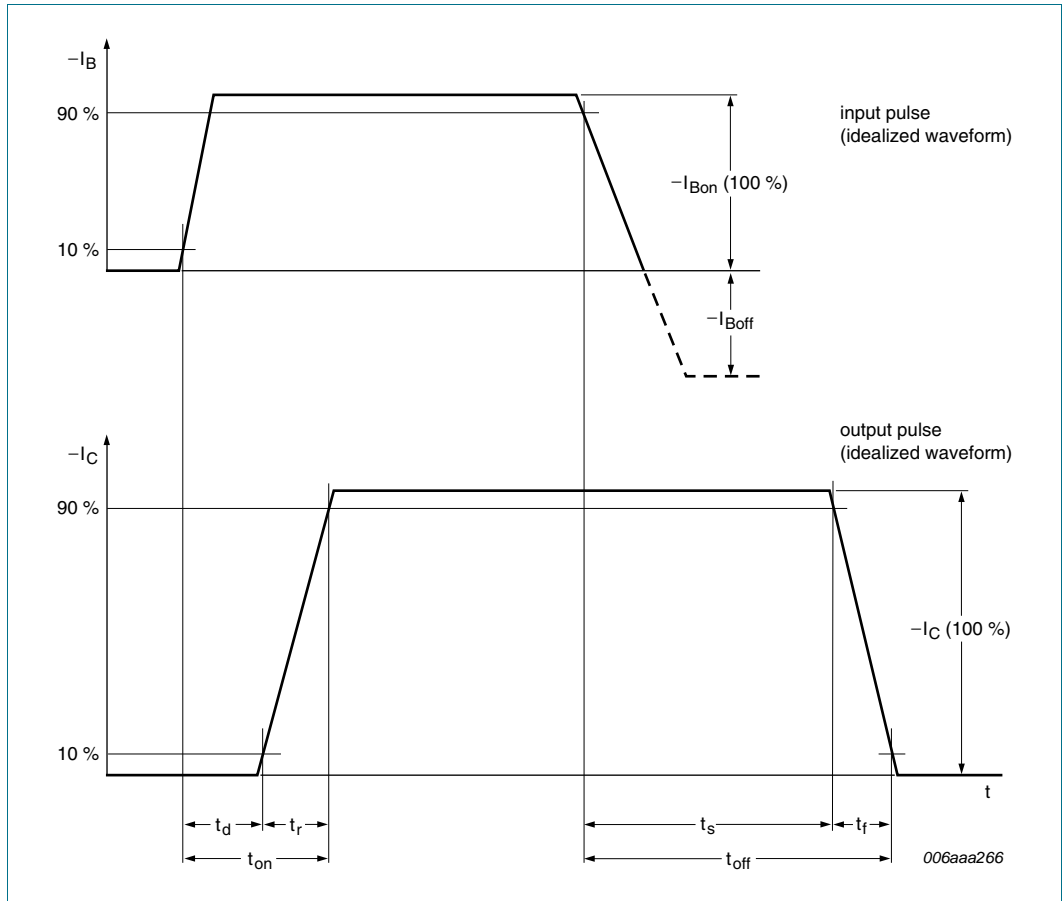

**Fig 13. BISS transistor switching time definition**

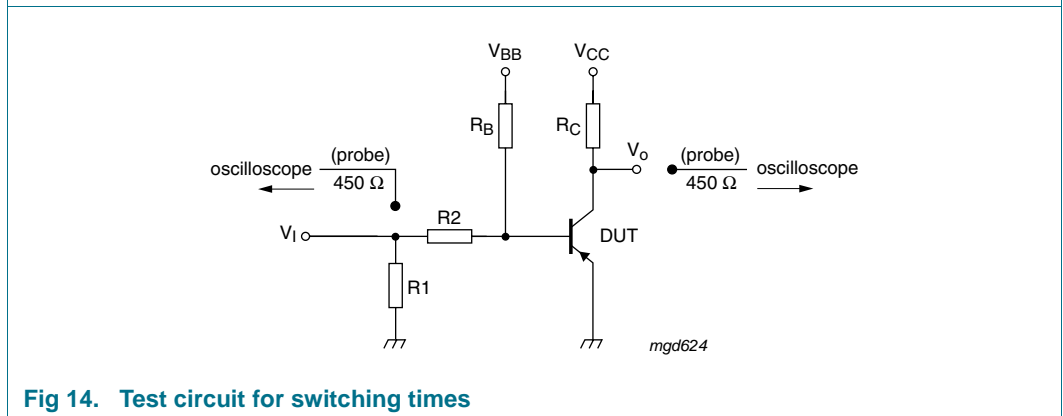
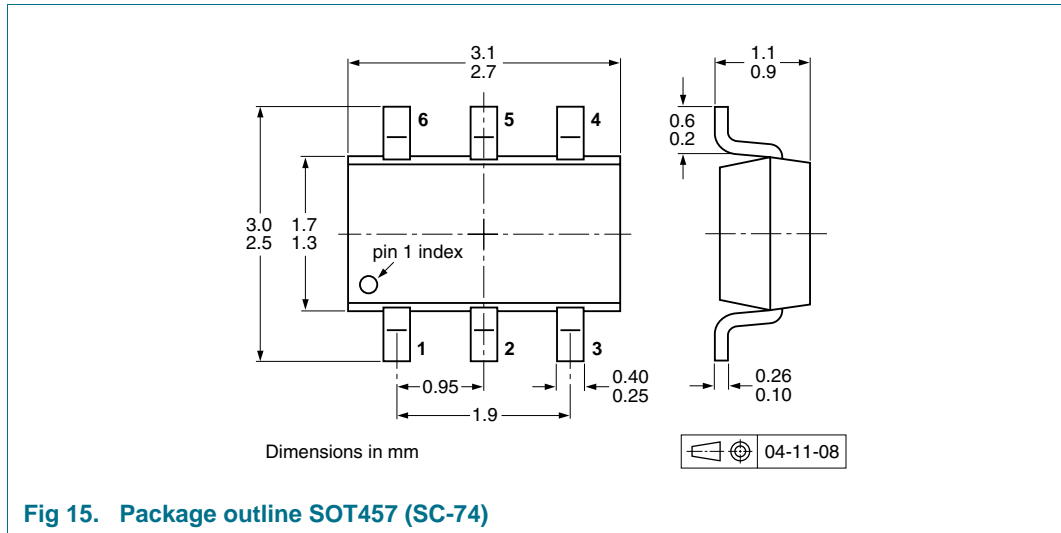

**Fig 14. Test circuit for switching times**

**8.1 Quality information**

This product has been qualified in accordance with the Automotive Electronics Council (AEC) standard Q101 - *Stress test qualification for discrete semiconductors*, and is suitable for use in automotive applications.

## 9. Package outline



## 10. Packing information

**Table 8. Packing methods**

The indicated -xxx are the last three digits of the 12NC ordering code.<sup>[1]</sup>

| Type number | Package | Description                    | Packing quantity |       |
|-------------|---------|--------------------------------|------------------|-------|
|             |         |                                | 3000             | 10000 |
| PBSS4032PD  | SOT457  | 4 mm pitch, 8 mm tape and reel | [2] -115         | -135  |
|             |         | 4 mm pitch, 8 mm tape and reel | [3] -215         | -235  |

[1] For further information and the availability of packing methods, see [Section 14](#).

[2] T1: normal taping

[3] T2: reverse taping

## 11. Soldering

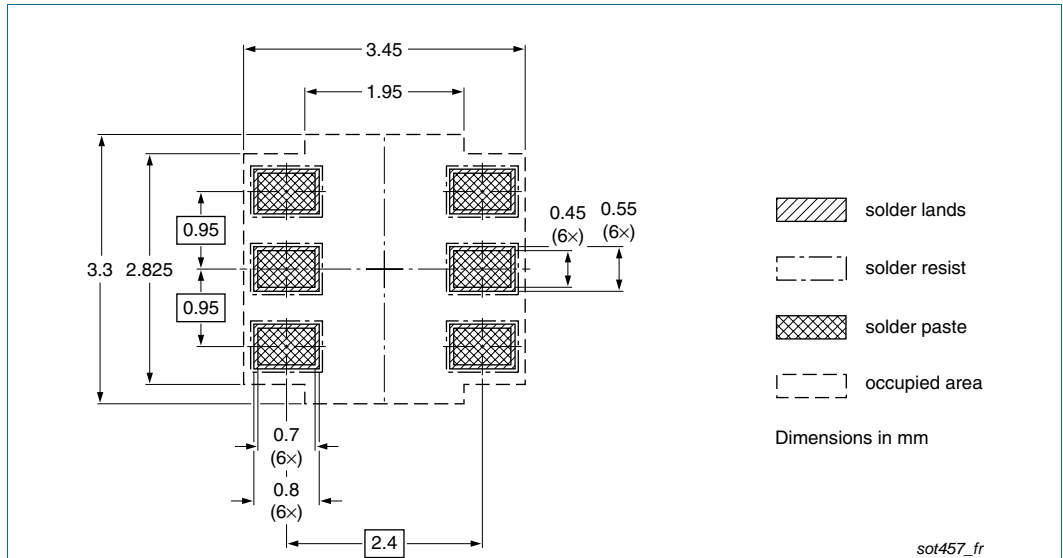

**Fig 16. Reflow soldering footprint SOT457 (SC-74)**

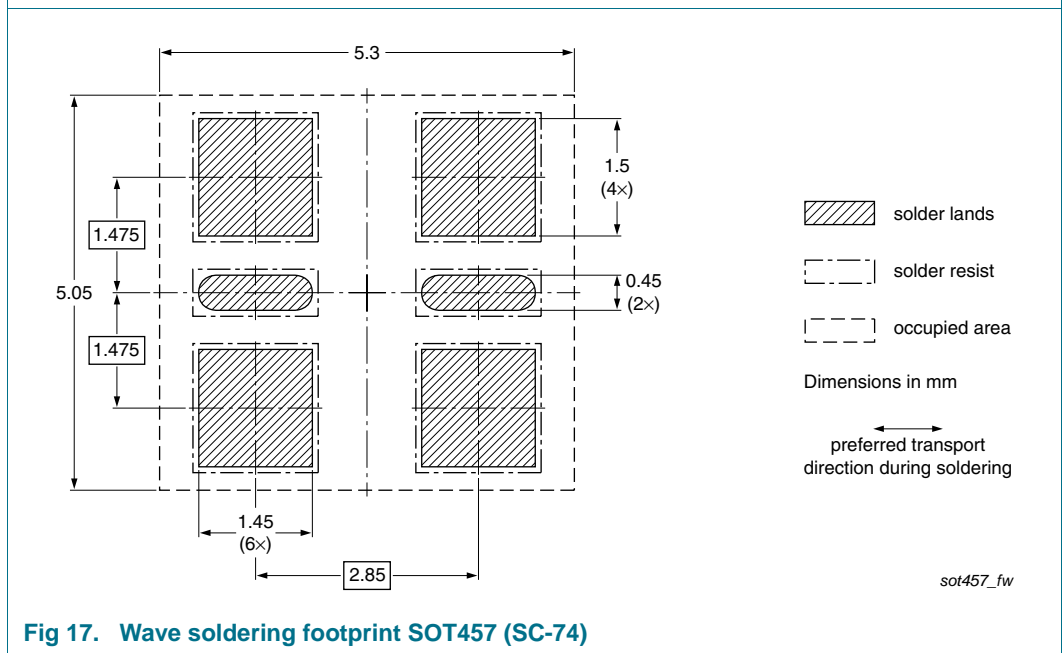

**Fig 17. Wave soldering footprint SOT457 (SC-74)**

## 12. Revision history

Table 9. Revision history

| Document ID  | Release date | Data sheet status  | Change notice | Supersedes |
|--------------|--------------|--------------------|---------------|------------|
| PBSS4032PD_1 | 20100127     | Product data sheet | -             | -          |

## 13. Legal information

### 13.1 Data sheet status

| Document status <sup>[1][2]</sup> | Product status <sup>[3]</sup> | Definition  |
|-----------------------------------|-------------------------------|---|
| Objective [short] data sheet      | Development                   | This document contains data from the objective specification for product development. |
| Preliminary [short] data sheet    | Qualification                 | This document contains data from the preliminary specification.                       |
| Product [short] data sheet        | Production                    | This document contains the product specification.                                     |

[1] Please consult the most recently issued document before initiating or completing a design.

[2] The term 'short data sheet' is explained in section "Definitions".

[3] The product status of device(s) described in this document may have changed since this document was published and may differ in case of multiple devices. The latest product status information is available on the Internet at URL <http://www.nxp.com>.

### 13.2 Definitions

**Draft** — The document is a draft version only. The content is still under internal review and subject to formal approval, which may result in modifications or additions. NXP Semiconductors does not give any representations or warranties as to the accuracy or completeness of information included herein and shall have no liability for the consequences of use of such information.

**Short data sheet** — A short data sheet is an extract from a full data sheet with the same product type number(s) and title. A short data sheet is intended for quick reference only and should not be relied upon to contain detailed and full information. For detailed and full information see the relevant full data sheet, which is available on request via the local NXP Semiconductors sales office. In case of any inconsistency or conflict with the short data sheet, the full data sheet shall prevail.

### 13.3 Disclaimers

**General** — Information in this document is believed to be accurate and reliable. However, NXP Semiconductors does not give any representations or warranties, expressed or implied, as to the accuracy or completeness of such information and shall have no liability for the consequences of use of such information.

**Right to make changes** — NXP Semiconductors reserves the right to make changes to information published in this document, including without limitation specifications and product descriptions, at any time and without notice. This document supersedes and replaces all information supplied prior to the publication hereof.

**Suitability for use** — NXP Semiconductors products are not designed, authorized or warranted to be suitable for use in medical, military, aircraft, space or life support equipment, nor in applications where failure or malfunction of an NXP Semiconductors product can reasonably be expected to result in personal injury, death or severe property or environmental

damage. NXP Semiconductors accepts no liability for inclusion and/or use of NXP Semiconductors products in such equipment or applications and therefore such inclusion and/or use is at the customer's own risk.

**Applications** — Applications that are described herein for any of these products are for illustrative purposes only. NXP Semiconductors makes no representation or warranty that such applications will be suitable for the specified use without further testing or modification.

**Limiting values** — Stress above one or more limiting values (as defined in the Absolute Maximum Ratings System of IEC 60134) may cause permanent damage to the device. Limiting values are stress ratings only and operation of the device at these or any other conditions above those given in the Characteristics sections of this document is not implied. Exposure to limiting values for extended periods may affect device reliability.

**Terms and conditions of sale** — NXP Semiconductors products are sold subject to the general terms and conditions of commercial sale, as published at <http://www.nxp.com/profile/terms>, including those pertaining to warranty, intellectual property rights infringement and limitation of liability, unless explicitly otherwise agreed to in writing by NXP Semiconductors. In case of any inconsistency or conflict between information in this document and such terms and conditions, the latter will prevail.

**No offer to sell or license** — Nothing in this document may be interpreted or construed as an offer to sell products that is open for acceptance or the grant, conveyance or implication of any license under any copyrights, patents or other industrial or intellectual property rights.

**Export control** — This document as well as the item(s) described herein may be subject to export control regulations. Export might require a prior authorization from national authorities.

**Quick reference data** — The Quick reference data is an extract of the product data given in the Limiting values and Characteristics sections of this document, and as such is not complete, exhaustive or legally binding.

### 13.4 Trademarks

Notice: All referenced brands, product names, service names and trademarks are the property of their respective owners.

## 14. Contact information

For more information, please visit: <http://www.nxp.com>

For sales office addresses, please send an email to: [salesaddresses@nxp.com](mailto:salesaddresses@nxp.com)

## 15. Contents

|           |                                      |           |
|-----------|--------------------------------------|-----------|
| <b>1</b>  | <b>Product profile</b> .....         | <b>1</b>  |
| 1.1       | General description .....            | 1         |
| 1.2       | Features .....                       | 1         |
| 1.3       | Applications .....                   | 1         |
| 1.4       | Quick reference data .....           | 1         |
| <b>2</b>  | <b>Pinning information</b> .....     | <b>2</b>  |
| <b>3</b>  | <b>Ordering information</b> .....    | <b>2</b>  |
| <b>4</b>  | <b>Marking</b> .....                 | <b>2</b>  |
| <b>5</b>  | <b>Limiting values</b> .....         | <b>2</b>  |
| <b>6</b>  | <b>Thermal characteristics</b> ..... | <b>4</b>  |
| <b>7</b>  | <b>Characteristics</b> .....         | <b>6</b>  |
| <b>8</b>  | <b>Test information</b> .....        | <b>9</b>  |
| 8.1       | Quality information .....            | 9         |
| <b>9</b>  | <b>Package outline</b> .....         | <b>10</b> |
| <b>10</b> | <b>Packing information</b> .....     | <b>10</b> |
| <b>11</b> | <b>Soldering</b> .....               | <b>11</b> |
| <b>12</b> | <b>Revision history</b> .....        | <b>12</b> |
| <b>13</b> | <b>Legal information</b> .....       | <b>13</b> |
| 13.1      | Data sheet status .....              | 13        |
| 13.2      | Definitions .....                    | 13        |
| 13.3      | Disclaimers .....                    | 13        |
| 13.4      | Trademarks .....                     | 13        |
| <b>14</b> | <b>Contact information</b> .....     | <b>13</b> |
| <b>15</b> | <b>Contents</b> .....                | <b>14</b> |

Please be aware that important notices concerning this document and the product(s) described herein, have been included in section 'Legal information'.



© NXP B.V. 2010.

All rights reserved.

For more information, please visit: <http://www.nxp.com>



For sales office addresses, please send an email to: [salesaddresses@nxp.com](mailto:salesaddresses@nxp.com)

Date of release: 27 January 2010

Document identifier: PBSS4032PD\_1

## Looking for pricing, stock, or lifecycle information?

Click below to explore more details on WIN SOURCE:

-  [View PBSS4032PD,115 on WIN SOURCE](#)
-  [Nexperia USA Inc. Information](#)

## Optimize Your Supply Chain with WIN SOURCE Solutions

-  Global Sourcing Solution
-  Obsolete Management
-  Cost Control Management
-  Shortage Management
-  Alternative Solution
-  Excess Inventory Management