



# THE DATASHEET OF AOI518



### General Description

- Latest Trench Power MOSFET technology
- Very Low  $R_{DS(on)}$  at 4.5V  $V_{GS}$
- Low Gate Charge
- High Current Capability
- RoHS and Halogen-Free Compliant

### Application

- DC/DC Converters in Computing
- Isolated DC/DC Converters in Telecom and Industrial

### Product Summary

$V_{DS}$	30V
$I_D$ (at $V_{GS}=10V$ )	46A
$R_{DS(ON)}$ (at $V_{GS}=10V$ )	< 5.2m $\Omega$
$R_{DS(ON)}$ (at $V_{GS} = 4.5V$ )	< 11.9m $\Omega$

100% UIS Tested  
 100%  $R_g$  Tested

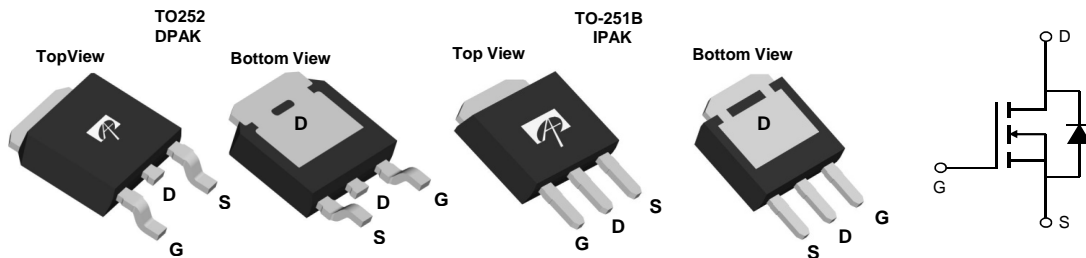

### Absolute Maximum Ratings $T_A=25^\circ\text{C}$ unless otherwise noted

Parameter	Symbol	Maximum	Units
Drain-Source Voltage	$V_{DS}$	30	V
Gate-Source Voltage	$V_{GS}$	$\pm 20$	V
Continuous Drain Current <sup>G</sup>	$I_D$	$T_C=25^\circ\text{C}$	46
		$T_C=100^\circ\text{C}$	36
Pulsed Drain Current <sup>C</sup>	$I_{DM}$	200	A
Continuous Drain Current	$I_{DSM}$	$T_A=25^\circ\text{C}$	18
		$T_A=70^\circ\text{C}$	14
Avalanche Current <sup>C</sup>	$I_{AS}$	25	A
Avalanche energy $L=0.1\text{mH}$ <sup>C</sup>	$E_{AS}$	31	mJ
$V_{DS}$ Spike	$V_{SPIKE}$	36	V
Power Dissipation <sup>B</sup>	$P_D$	$T_C=25^\circ\text{C}$	50
		$T_C=100^\circ\text{C}$	25
Power Dissipation <sup>A</sup>	$P_{DSM}$	$T_A=25^\circ\text{C}$	2.5
		$T_A=70^\circ\text{C}$	1.6
Junction and Storage Temperature Range	$T_J, T_{STG}$	-55 to 175	$^\circ\text{C}$

### Thermal Characteristics

Parameter	Symbol	Typ	Max	Units
Maximum Junction-to-Ambient <sup>A</sup>	$R_{\theta JA}$	16	20	$^\circ\text{C}/\text{W}$
Maximum Junction-to-Ambient <sup>A,D</sup>		41	50	$^\circ\text{C}/\text{W}$
Maximum Junction-to-Case	$R_{\theta JC}$	2.5	3	$^\circ\text{C}/\text{W}$

**Electrical Characteristics (T<sub>J</sub>=25°C unless otherwise noted)**

Symbol	Parameter	Conditions	Min	Typ	Max	Units
<b>STATIC PARAMETERS</b>						
BV <sub>DSS</sub>	Drain-Source Breakdown Voltage	I <sub>D</sub> =250μA, V <sub>GS</sub> =0V	30			V
I <sub>DSS</sub>	Zero Gate Voltage Drain Current	V <sub>DS</sub> =30V, V <sub>GS</sub> =0V T <sub>J</sub> =55°C			1 5	μA
I <sub>GSS</sub>	Gate-Body leakage current	V <sub>DS</sub> =0V, V <sub>GS</sub> = ±20V			100	nA
V <sub>GS(th)</sub>	Gate Threshold Voltage	V <sub>DS</sub> =V <sub>GS</sub> , I <sub>D</sub> =250μA	1.8	2.2	2.6	V
R <sub>DS(ON)</sub>	Static Drain-Source On-Resistance	V <sub>GS</sub> =10V, I <sub>D</sub> =20A T <sub>J</sub> =125°C	3.4	4.3	5.2	mΩ
		V <sub>GS</sub> =4.5V, I <sub>D</sub> =20A	6	9.1	11.9	mΩ
g <sub>FS</sub>	Forward Transconductance	V <sub>DS</sub> =5V, I <sub>D</sub> =20A		91		S
V <sub>SD</sub>	Diode Forward Voltage	I <sub>S</sub> =1A, V <sub>GS</sub> =0V		0.7	1	V
I <sub>S</sub>	Maximum Body-Diode Continuous Current <sup>G</sup>				46	A
<b>DYNAMIC PARAMETERS</b>						
C <sub>iss</sub>	Input Capacitance	V <sub>GS</sub> =0V, V <sub>DS</sub> =15V, f=1MHz	600	1187	1780	pF
C <sub>oss</sub>	Output Capacitance		240	483	730	pF
C <sub>rss</sub>	Reverse Transfer Capacitance		30	60	90	pF
R <sub>g</sub>	Gate resistance	V <sub>GS</sub> =0V, V <sub>DS</sub> =0V, f=1MHz	0.7	1.5	2.3	Ω
<b>SWITCHING PARAMETERS</b>						
Q <sub>g</sub> (10V)	Total Gate Charge	V <sub>GS</sub> =10V, V <sub>DS</sub> =15V, I <sub>D</sub> =20A		18		nC
Q <sub>g</sub> (4.5V)	Total Gate Charge			8.8		nC
Q <sub>gs</sub>	Gate Source Charge			4.1		nC
Q <sub>gd</sub>	Gate Drain Charge			3.6		nC
t <sub>D(on)</sub>	Turn-On Delay Time	V <sub>GS</sub> =10V, V <sub>DS</sub> =15V, R <sub>L</sub> =0.75Ω, R <sub>GEN</sub> =3Ω		7.3		ns
t <sub>r</sub>	Turn-On Rise Time			10.5		ns
t <sub>D(off)</sub>	Turn-Off Delay Time			21.8		ns
t <sub>f</sub>	Turn-Off Fall Time			5		ns
t <sub>rr</sub>	Body Diode Reverse Recovery Time		I <sub>F</sub> =20A, dI/dt=500A/μs		14.7	
Q <sub>rr</sub>	Body Diode Reverse Recovery Charge	I <sub>F</sub> =20A, dI/dt=500A/μs		24		nC

- A. The value of R<sub>θJA</sub> is measured with the device mounted on 1in<sup>2</sup> FR-4 board with 2oz. Copper, in a still air environment with T<sub>A</sub>=25° C. The Power dissipation P<sub>DSM</sub> is based on R<sub>θJA</sub> and the maximum allowed junction temperature of 150° C. The value in any given application depends on the user's specific board design, and the maximum temperature of 175° C may be used if the PCB allows it.
- B. The power dissipation P<sub>D</sub> is based on T<sub>J(MAX)</sub>=175° C, using junction-to-case thermal resistance, and is more useful in setting the upper dissipation limit for cases where additional heatsinking is used.
- C. Single pulse width limited by junction temperature T<sub>J(MAX)</sub>=175° C.
- D. The R<sub>θJA</sub> is the sum of the thermal impedance from junction to case R<sub>θJC</sub> and case to ambient.
- E. The static characteristics in Figures 1 to 6 are obtained using <300μs pulses, duty cycle 0.5% max.
- F. These curves are based on the junction-to-case thermal impedance which is measured with the device mounted to a large heatsink, assuming a maximum junction temperature of T<sub>J(MAX)</sub>=175° C. The SOA curve provides a single pulse rating.
- G. The maximum current rating is package limited.
- H. These tests are performed with the device mounted on 1 in<sup>2</sup> FR-4 board with 2oz. Copper, in a still air environment with T<sub>A</sub>=25° C.

THIS PRODUCT HAS BEEN DESIGNED AND QUALIFIED FOR THE CONSUMER MARKET. APPLICATIONS OR USES AS CRITICAL COMPONENTS IN LIFE SUPPORT DEVICES OR SYSTEMS ARE NOT AUTHORIZED. AOS DOES NOT ASSUME ANY LIABILITY ARISING OUT OF SUCH APPLICATIONS OR USES OF ITS PRODUCTS. AOS RESERVES THE RIGHT TO IMPROVE PRODUCT DESIGN, FUNCTIONS AND RELIABILITY WITHOUT NOTICE.

TYPICAL ELECTRICAL AND THERMAL CHARACTERISTICS

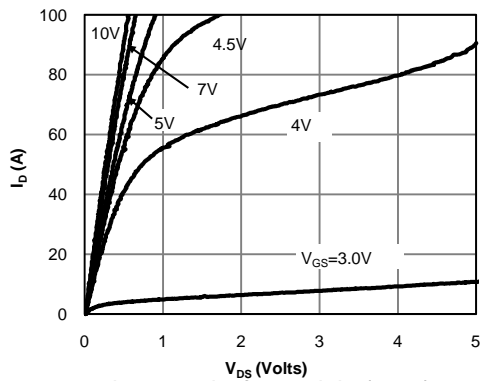

Fig 1: On-Region Characteristics (Note E)

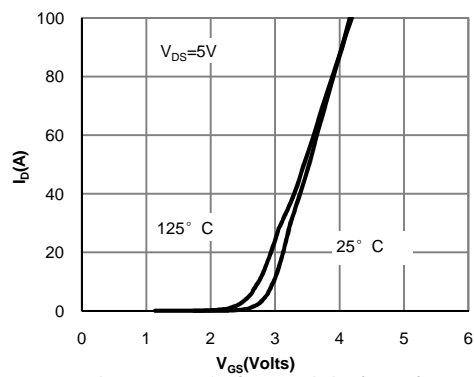

Figure 2: Transfer Characteristics (Note E)

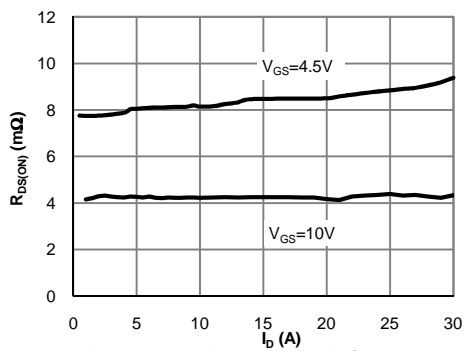

Figure 3: On-Resistance vs. Drain Current and Gate Voltage (Note E)

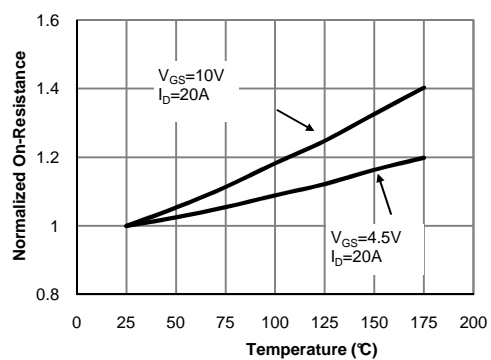

Figure 4: On-Resistance vs. Junction Temperature (Note E)

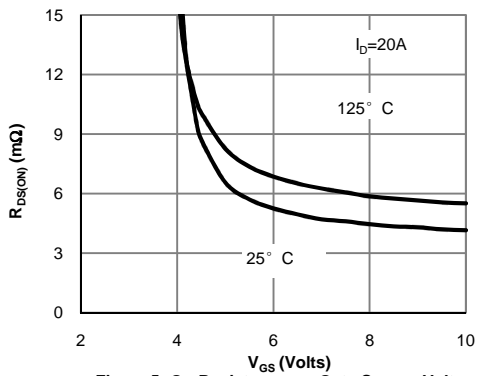

Figure 5: On-Resistance vs. Gate-Source Voltage (Note E)

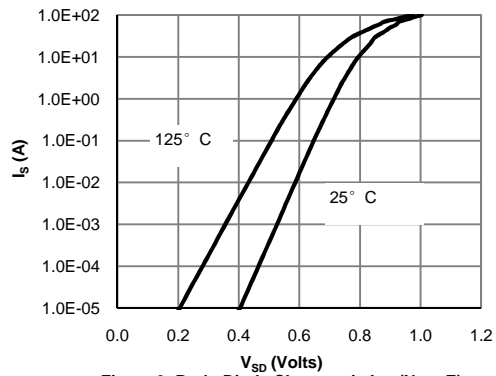

Figure 6: Body-Diode Characteristics (Note E)

TYPICAL ELECTRICAL AND THERMAL CHARACTERISTICS

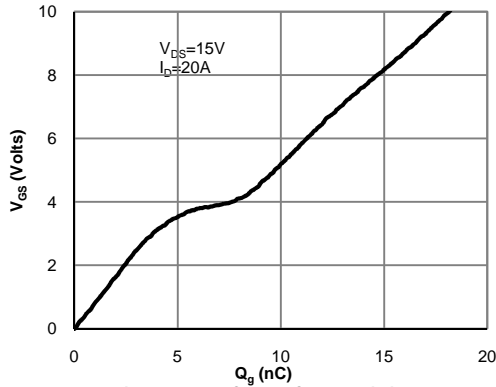

Figure 7: Gate-Charge Characteristics

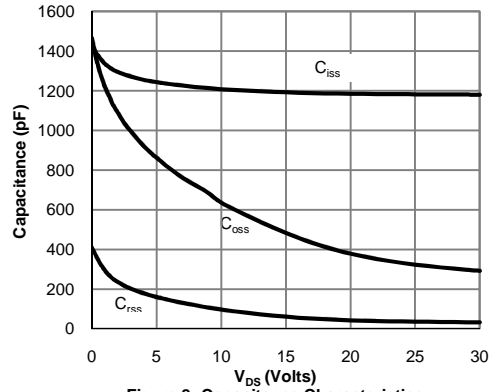

Figure 8: Capacitance Characteristics

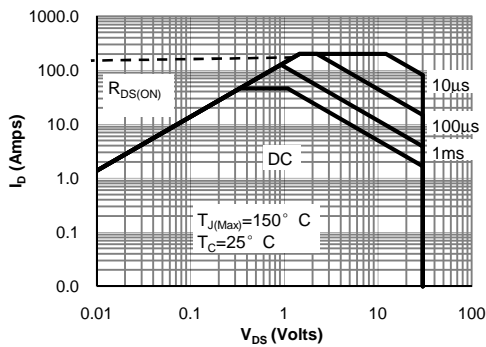

Figure 9: Maximum Forward Biased Safe Operating Area (Note F)

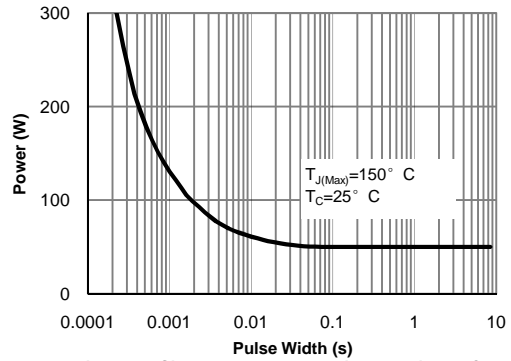

Figure 10: Single Pulse Power Rating Junction-to-Case (Note F)

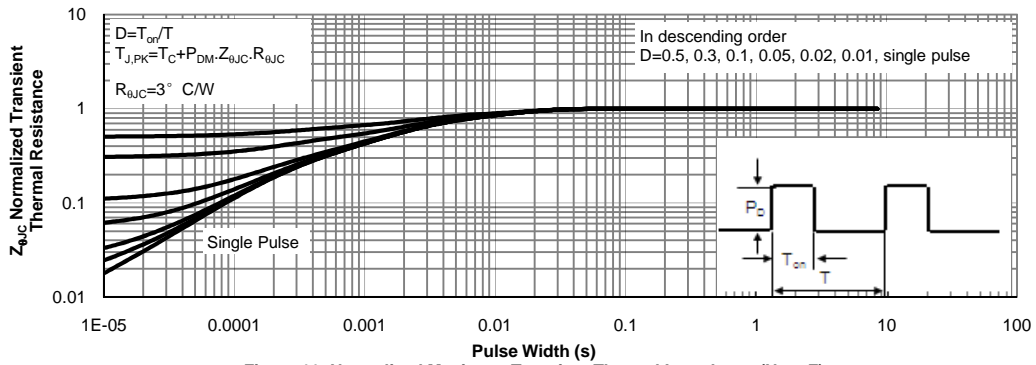

Figure 11: Normalized Maximum Transient Thermal Impedance (Note F)

TYPICAL ELECTRICAL AND THERMAL CHARACTERISTICS

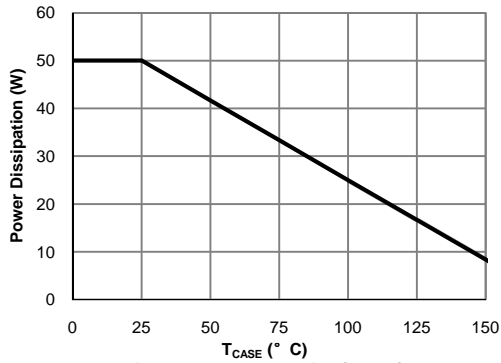

Figure 12: Power De-rating (Note F)

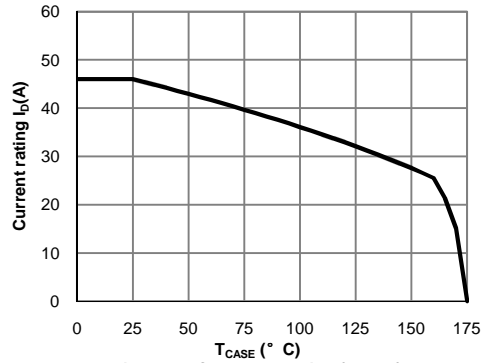

Figure 13: Current De-rating (Note F)

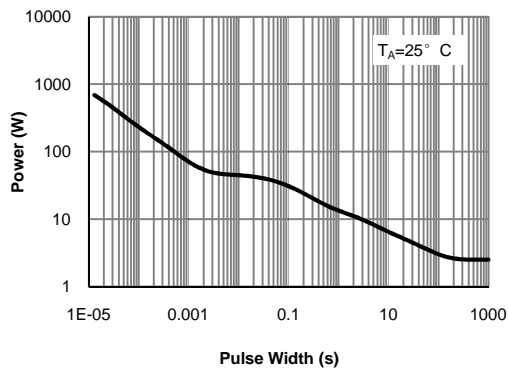

Figure 14: Single Pulse Power Rating Junction-to-Ambient (Note H)

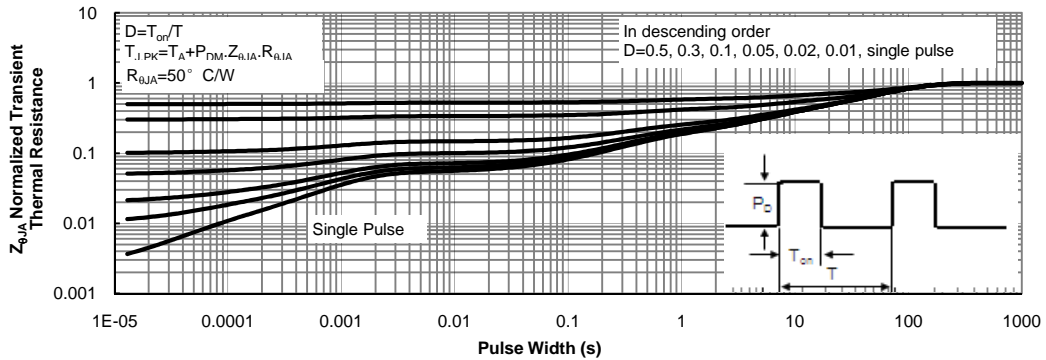
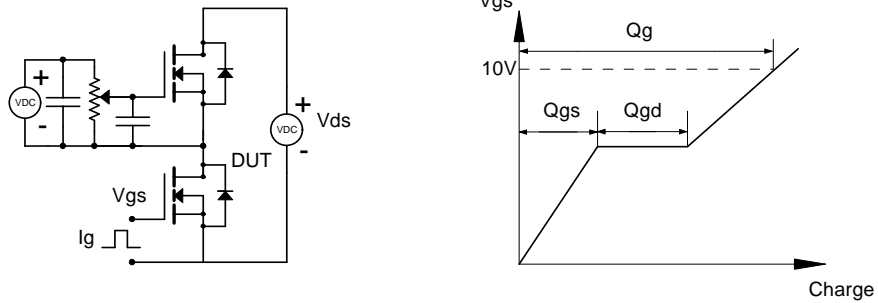
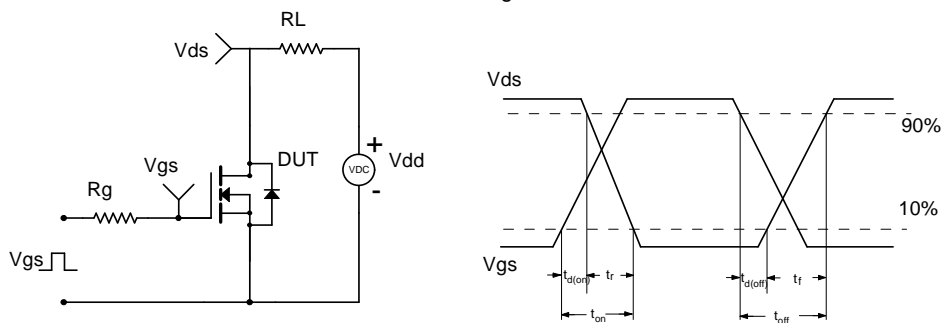

Figure 15: Normalized Maximum Transient Thermal Impedance (Note H)

Gate Charge Test Circuit & Waveform



Resistive Switching Test Circuit & Waveforms



Unclamped Inductive Switching (UIS) Test Circuit & Waveforms

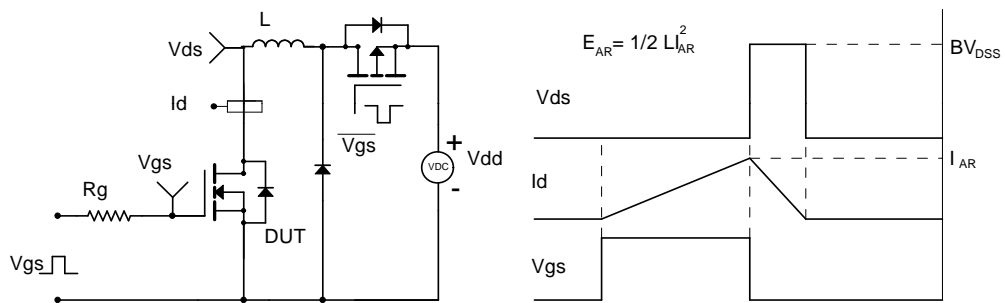

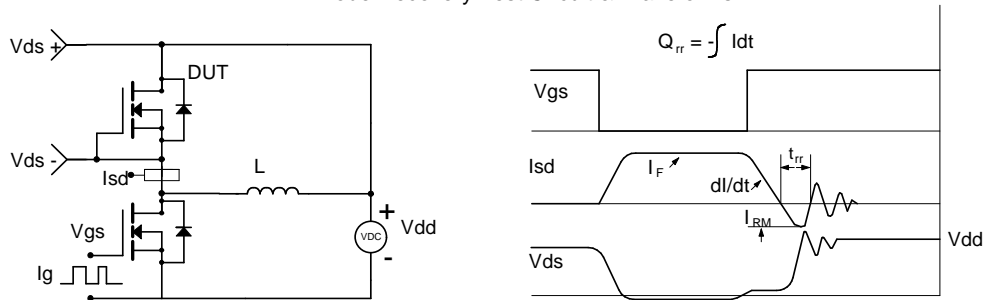

Diode Recovery Test Circuit & Waveforms



## Looking for pricing, stock, or lifecycle information?

Click below to explore more details on WIN SOURCE:

-  [View AOI518 on WIN SOURCE](#)
-  [Alpha & Omega Semiconductor Inc. Information](#)

## Optimize Your Supply Chain with WIN SOURCE Solutions

-  Global Sourcing Solution
-  Obsolete Management
-  Cost Control Management
-  Shortage Management
-  Alternative Solution
-  Excess Inventory Management