

High Performance Single 150 mA LDO

Features

- Tiny 1 mm x 1 mm UDFN, SOT23-5, and TSOT23-5 Packages
- Wide 2.5V to 6V Operating Range
- 150 mA Output Current
- Stable with 1 μ F Ceramic Output Capacitors
- Low Dropout Voltage: 155 mV @ 150 mA
- Excellent Load/Line Transient Response
- Low Quiescent Current: 29 μ A
- High PSRR: 70 dB
- Thermal-Shutdown and Current-Limit Protection

Applications

- USB Dongles
- Wireless LANs
- PC Desktops, Laptops, and Tablets
- Battery-Powered Equipment
- Digital Still and Video Cameras
- 5V General Purpose

General Description

The MIC5317 is a high performance 150 mA low dropout regulator that offers high power supply rejection (PSRR) in an ultra-small 1 mm x 1 mm package for stringent space requirements and demanding performance. The MIC5317 operates from an input voltage from 2.5V to 6.0V and is capable of providing the output voltages of 1.0V to 3.6V making it ideal for USB port or 6V AC adapter applications.

The MIC5317 offers 2% initial accuracy, low dropout voltage (155 mV @ 150 mA), and low ground current (typically 29 μ A). The MIC5317 can also be put into a zero off-mode current state, drawing virtually no current when disabled.

The MIC5317 is available in several advanced packages including a lead-free (RoHS-compliant) 1 mm x 1 mm UDFN that occupies only 1 mm² of PCB area, a 75% reduction in board area compared to SC-70 and 2 mm x 2 mm DFN packages. It is also available in a SOT23-5 and TSOT23-5 package.

The MIC5317 has an operating junction temperature range of -40°C to 125°C .

Package Types

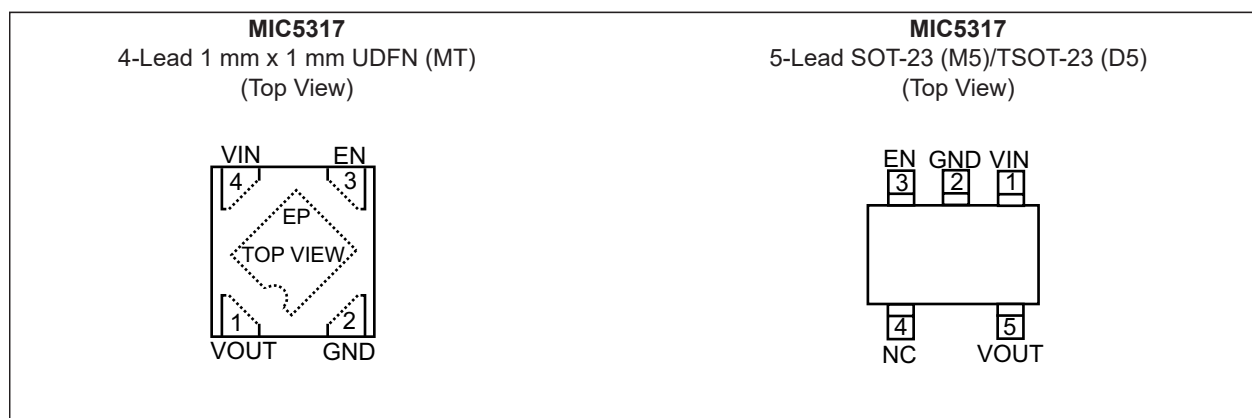

MIC5317

Typical Application Circuit

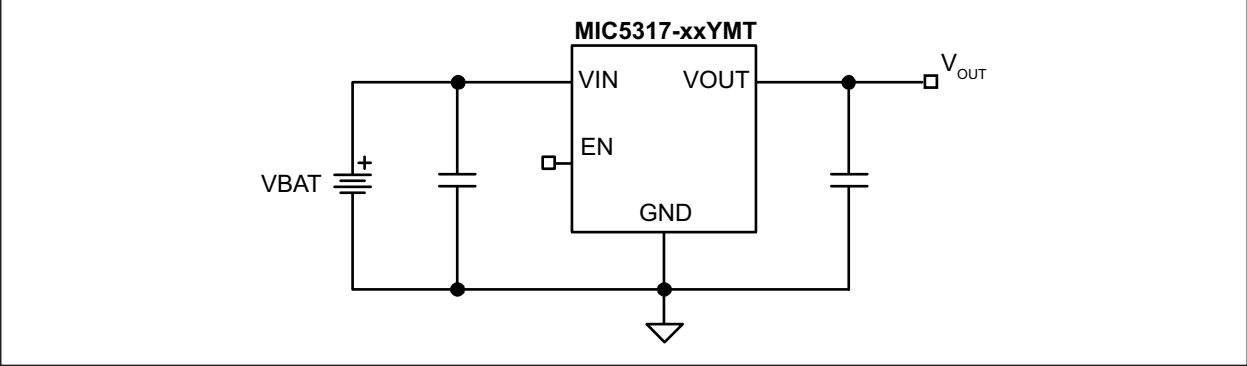

Functional Block Diagram

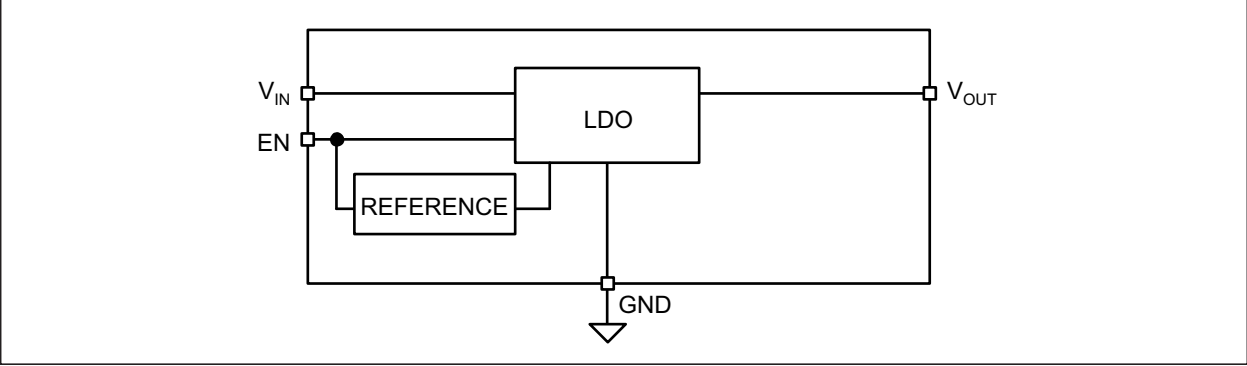

1.0 ELECTRICAL CHARACTERISTICS

Absolute Maximum Ratings †

Supply Voltage (V_{IN})	0V to +7V
Enable Voltage (V_{EN})	0V to V_{IN}
Power Dissipation (P_D)	Internally Limited (Note 1)
ESD Rating (HBM, Note 2)	2 kV

Operating Ratings ††

Supply Voltage (V_{IN})	+2.5V to +6V
Enable Voltage (V_{EN})	0V to V_{IN}

† Notice: Stresses above those listed under “Absolute Maximum Ratings” may cause permanent damage to the device. This is a stress rating only and functional operation of the device at those or any other conditions above those indicated in the operational sections of this specification is not intended. Exposure to maximum rating conditions for extended periods may affect device reliability.

†† Notice: The device is not guaranteed to function outside its operating ratings.

Note 1: The maximum allowable power dissipation of any T_A (ambient temperature) is $P_{D(MAX)} = (T_{J(MAX)} - T_A) / \theta_{JA}$. Exceeding the maximum allowable power dissipation will result in excessive die temperature and the regulator will go into thermal shutdown.

2: Devices are ESD sensitive. Handling precautions are recommended. Human body model, 1.5 k Ω in series with 100 pF.

MIC5317

ELECTRICAL CHARACTERISTICS

Electrical Characteristics: $V_{IN} = V_{EN} = V_{OUT} + 1V$; $C_{IN} = C_{OUT} = 1 \mu F$; $I_{OUT} = 100 \mu A$; $T_J = +25^\circ C$, **bold** values valid for $-40^\circ C$ to $+125^\circ C$, unless noted. [Note 1](#)

Parameter	Sym.	Min.	Typ.	Max.	Units	Conditions
Output Voltage Accuracy		-2.0	—	2.0	%	Variation from nominal V_{OUT}
		-3.0	—	3.0		Variation from nominal V_{OUT} : $-40^\circ C$ to $+125^\circ C$
Line Regulation		—	0.02	0.3	%	$V_{IN} = V_{OUT} + 1V$ to 6V; $I_{OUT} = 100 \mu A$
Load Regulation (Note 2)		—	10	25	mV	$I_{OUT} = 100 \mu A$ to 150 mA
Dropout Voltage (Note 3)	V_{DO}	—	55	110	mV	$I_{OUT} = 50 mA$; $V_{OUT} \geq 2.8V$
		—	155	310		$I_{OUT} = 150 mA$; $V_{OUT} \geq 2.8V$
		—	60	135		$I_{OUT} = 50 mA$; $V_{OUT} < 2.8V$
		—	180	380		$I_{OUT} = 150 mA$; $V_{OUT} < 2.8V$
Ground Pin Current (Note 4)	I_{GND}	—	29	39	μA	$I_{OUT} = 0 mA$
Ground Pin Current in Shutdown	I_{SHDN}	—	0.05	1	μA	$V_{EN} = 0V$
Ripple Rejection	PSRR	—	80	—	dB	$f = \text{Up to } 1 \text{ kHz}$; $C_{OUT} = 1 \mu F$
		—	65	—		$f = 1 \text{ kHz to } 10 \text{ kHz}$; $C_{OUT} = 1 \mu F$
Current Limit	I_{LIM}	200	325	550	mA	$V_{OUT} = 0V$
Output Voltage Noise	e_N	—	200	—	μV_{RMS}	$C_{OUT} = 1 \mu F$, 10 Hz to 100 kHz
Enable Input						
Enable Input Voltage	V_{EN}	—	—	0.2	V	Logic low
		1.2	—	—		Logic high
Enable Input Current	I_{EN}	—	0.01	1	μA	$V_{IL} \leq 0.2V$
		—	0.01	1		$V_{IH} \geq 1.2V$
Turn-On Time	t_{ON}	—	50	125	μs	$C_{OUT} = 1 \mu F$; $I_{OUT} = 150 mA$

Note 1: Specification for packaged product only.

- 2:** Regulation is measured at constant junction temperature using low duty cycle pulse testing; changes in output voltage due to heating effects are covered by the thermal regulation specification.
- 3:** Dropout voltage is defined as the input-to-output differential at which the output voltage drops 2% below its nominal value measured at 1V differential. For outputs below 2.5V, dropout voltage is the input-to-output differential with the minimum input voltage 2.5V.
- 4:** Ground pin current is the regulator quiescent current. The total current drawn from the supply is the sum of the load current plus the ground pin current.

TEMPERATURE SPECIFICATIONS

Parameters	Sym.	Min.	Typ.	Max.	Units	Conditions
Temperature Ranges						
Max. Junction Temperature Range	T_J	-40	—	+150	°C	—
Operating Junction Temperature Range	T_J	-40	—	+125	°C	—
Storage Temperature Range	T_S	-65	—	+150	°C	—
Lead Temperature	—	—	—	+260	°C	Soldering, 10 sec.
Package Thermal Resistances						
Thermal Resistance, 1x1 4-Ld UDFN	θ_{JA}	—	240	—	°C/W	—
Thermal Resistance, SOT23-5	θ_{JA}	—	253	—	°C/W	—
Thermal Resistance, TSOT23-5	θ_{JA}	—	253	—	°C/W	—

Note 1: The maximum allowable power dissipation is a function of ambient temperature, the maximum allowable junction temperature and the thermal resistance from junction to air (i.e., T_A , T_J , θ_{JA}). Exceeding the maximum allowable power dissipation will cause the device operating junction temperature to exceed the maximum +125°C rating. Sustained junction temperatures above +125°C can impact the device reliability.

MIC5317

2.0 TYPICAL PERFORMANCE CURVES

Note: The graphs and tables provided following this note are a statistical summary based on a limited number of samples and are provided for informational purposes only. The performance characteristics listed herein are not tested or guaranteed. In some graphs or tables, the data presented may be outside the specified operating range (e.g., outside specified power supply range) and therefore outside the warranted range.

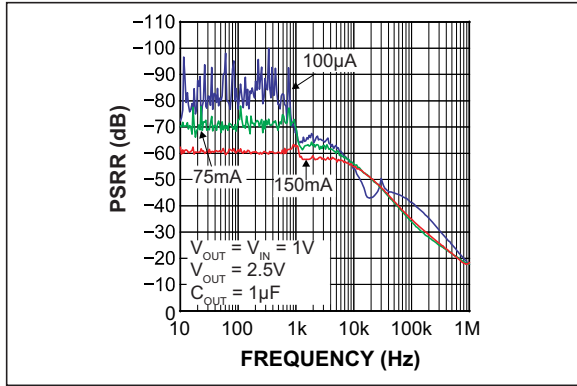

FIGURE 2-1: Power Supply Rejection Ratio.

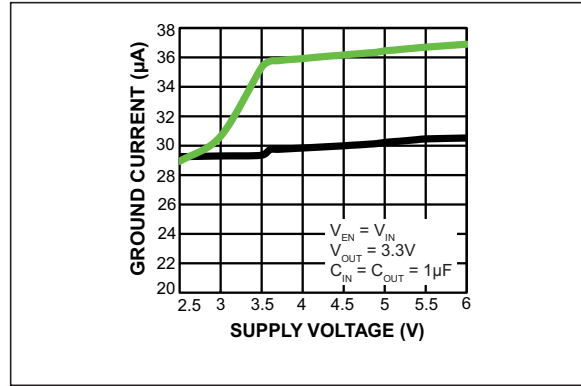

FIGURE 2-4: Ground Current vs. Supply Voltage.

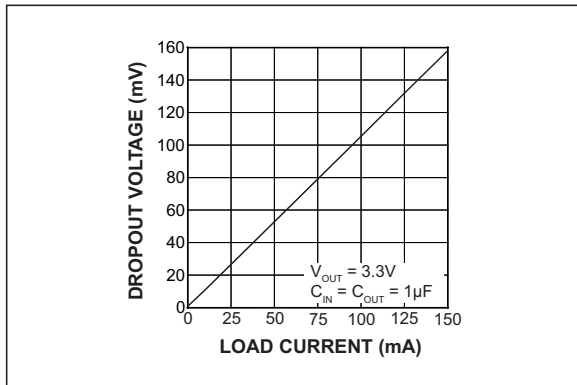

FIGURE 2-2: Dropout Voltage vs. Load Current.

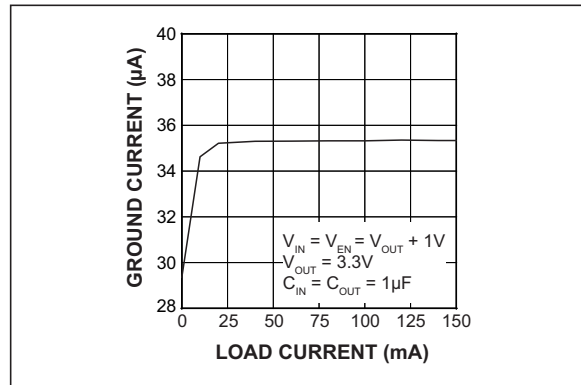

FIGURE 2-5: Ground Current vs. Load Current.

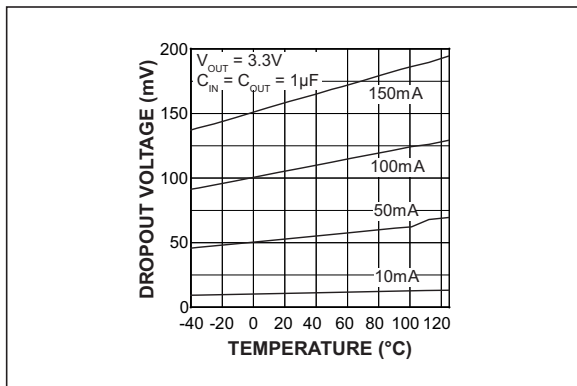

FIGURE 2-3: Dropout Voltage vs. Temperature.

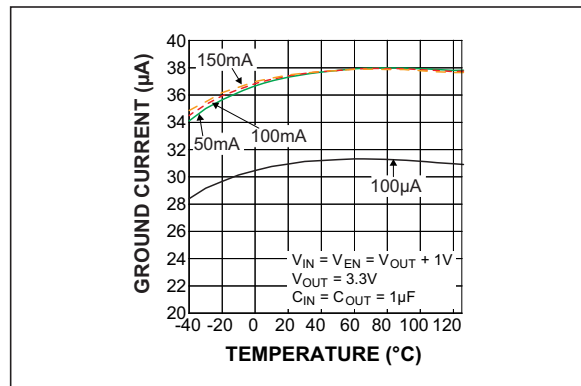

FIGURE 2-6: Ground Current vs. Temperature.

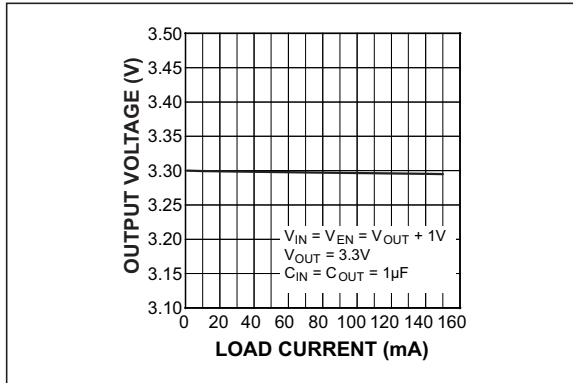

FIGURE 2-7: Output Voltage vs. Load Current.

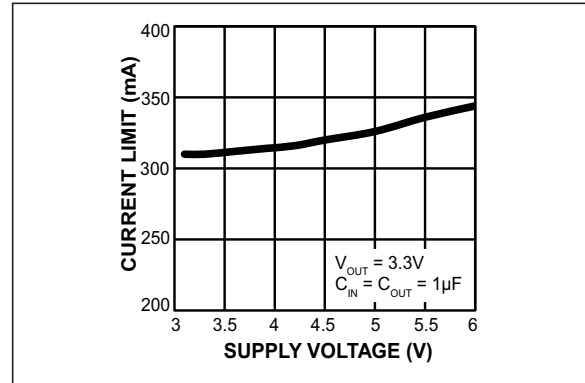

FIGURE 2-10: Current Limit vs. Supply Voltage.

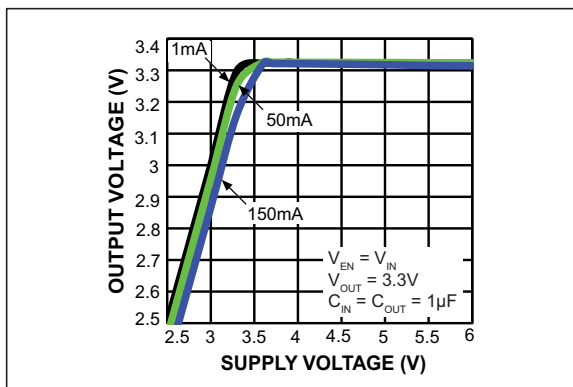

FIGURE 2-8: Output Voltage vs. Supply Voltage.

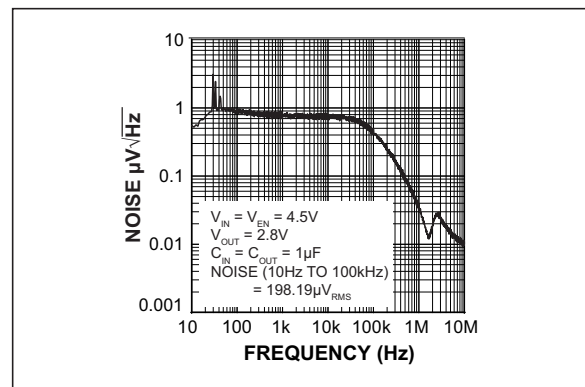

FIGURE 2-11: Output Noise Spectral Density.

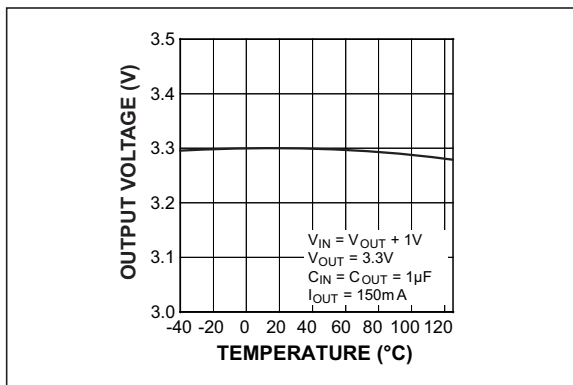

FIGURE 2-9: Output Voltage vs. Temperature.

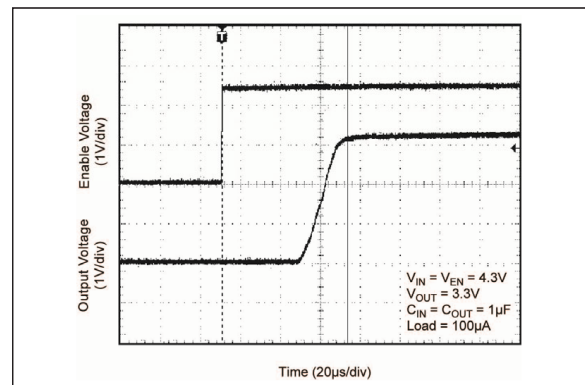

FIGURE 2-12: Enable Turn-On.

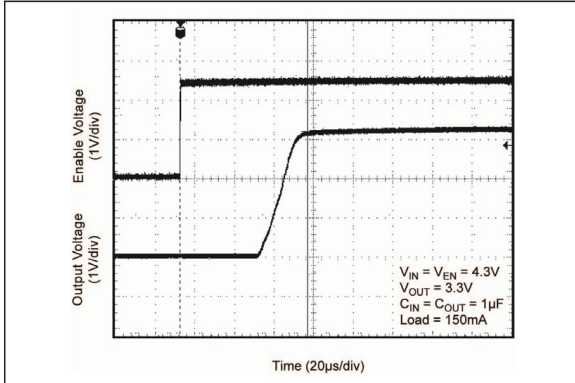

FIGURE 2-13: Enable Turn-On.

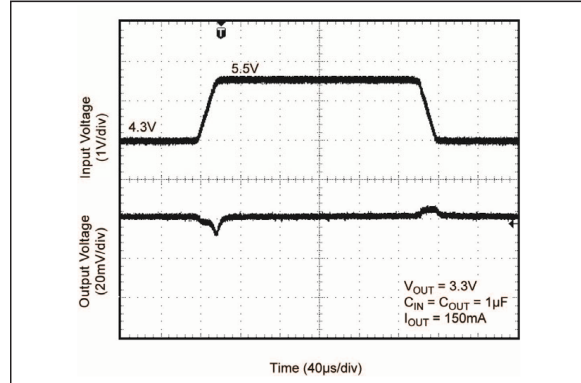

FIGURE 2-16: Line Transient.

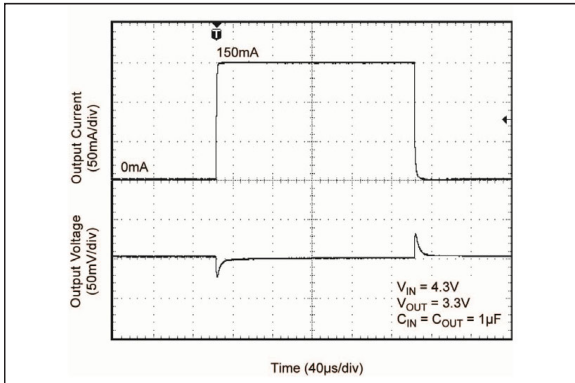

FIGURE 2-14: Load Transient.

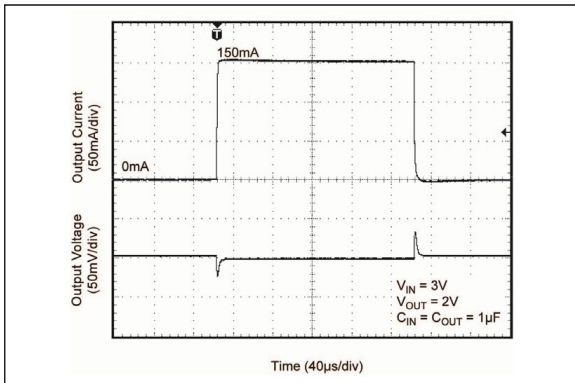

FIGURE 2-15: Load Transient.

3.0 PIN DESCRIPTIONS

The descriptions of the pins are listed in [Table 3-1](#).

TABLE 3-1: PIN FUNCTION TABLE

Pin Number	Pin Name UDFN-4	Pin Name SOT23-5	Pin Name TSOT23-5	Description
1	VOUT	—	—	Output voltage.
1	—	VIN	VIN	Supply input.
2	GND	GND	GND	Ground.
3	EN	EN	EN	Enable Input: Active-High. High = ON; Low = OFF. Do not leave floating.
4	VIN	—	—	Supply input.
4	—	NC	NC	No connect. Not internally connected.
5	—	VOUT	VOUT	Output voltage.
EP	ePAD	N/A	N/A	Exposed heat sink pad. Connect to ground.

MIC5317

4.0 APPLICATION INFORMATION

MIC5317 is a low-noise 150 mA LDO. The MIC5317 regulator is fully protected from damage due to fault conditions, offering linear current limiting and thermal shutdown.

4.1 Input Capacitor

The MIC5317 is a high-performance, high-bandwidth device. An input capacitor of 1 μF is required from the input to ground to provide stability. Low-ESR ceramic capacitors provide optimal performance at a minimum of space. Additional high-frequency capacitors, such as small-valued NPO dielectric-type capacitors, help filter out high-frequency noise and are good practice in any RF-based circuit. X5R or X7R dielectrics are recommended for the input capacitor. Y5V dielectrics lose most of their capacitance over temperature and are therefore, not recommended.

4.2 Output Capacitor

The MIC5317 requires an output capacitor of 1 μF or greater to maintain stability. The design is optimized for use with low-ESR ceramic chip capacitors. High-ESR capacitors are not recommended because they may cause high-frequency oscillation. The output capacitor can be increased, but performance has been optimized for a 1 μF ceramic output capacitor and does not improve significantly with larger capacitance.

X7R/X5R dielectric-type ceramic capacitors are recommended because of their temperature performance. X7R-type capacitors change capacitance by 15% over their operating temperature range and are the most stable type of ceramic capacitors. Z5U and Y5V dielectric capacitors change value by as much as 50% and 60%, respectively, over their operating temperature ranges. To use a ceramic-chip capacitor with Y5V dielectric, the value must be much higher than an X7R ceramic capacitor to ensure the same minimum capacitance over the equivalent operating temperature range.

4.3 No-Load Stability

Unlike many other voltage regulators, the MIC5317 will remain stable and in regulation with no load. This is especially important in CMOS RAM keep-alive applications.

4.4 Enable/Shutdown

The MIC5317 comes with an active-high enable pin that allows the regulator to be disabled. Forcing the enable pin low disables the regulator and sends it into a “zero” off-mode current state. In this state, current consumed by the regulator goes nearly to zero. Forcing the enable pin high enables the output voltage. The

active-high enable pin uses CMOS technology and the enable pin cannot be left floating. A floating enable pin may cause an indeterminate state on the output.

4.5 Thermal Considerations

The MIC5317 is designed to provide 150 mA of continuous current in a very small package. Maximum ambient operating temperature can be calculated based on the output current and the voltage drop across the part. For example if the input voltage is 3.6V, the output voltage is 2.8V, and the output current = 150 mA. The actual power dissipation of the regulator circuit can be determined using [Equation 4-1](#).

EQUATION 4-1:

$$P_D = (V_{IN} - V_{OUT1}) \times I_{OUT} + V_{IN} \times I_{GND}$$

Because this device is CMOS and the ground current is typically <100 μA over the load range, the power dissipation contributed by the ground current is <1% and can be ignored for [Equation 4-2](#).

EQUATION 4-2:

$$P_D = (3.6V - 2.8V) \times 150mA = 0.120W$$

To determine the maximum ambient operating temperature of the package, use the junction-to-ambient thermal resistance of the device and Equation 4-3.

EQUATION 4-3:

$$P_{D(MAX)} = \left(\frac{T_{J(MAX)} - T_A}{\theta_{JA}} \right)$$

$T_{J(MAX)} = 125^\circ\text{C}$, the maximum junction temperature of the die, θ_{JA} thermal resistance = 240°C/W for the YMT package and 253°C/W for the SOT23-5 and TSOT23-5 packages.

Substituting P_D for $P_{D(MAX)}$ and solving for the ambient operating temperature will give the maximum operating conditions for the regulator circuit. The junction-to-ambient thermal resistance for the minimum footprint is 240°C/W .

The maximum power dissipation must not be exceeded for proper operation.

For example, when operating the MIC5317-2.8YMT at an input voltage of 3.6V and 150 mA load with a minimum footprint layout, the maximum ambient operating temperature (T_A) can be determined as shown in [Equation 4-4](#):

EQUATION 4-4:

$$0.120W = (125^{\circ}C - T_A)/(240^{\circ}C/W)$$

$$T_A = 96^{\circ}C$$

Therefore the maximum ambient operating temperature of 96°C is allowed in a 1 mm × 1 mm UDFN package. For a full discussion of heat sinking and thermal effects on voltage regulators, refer to the “Regulator Thermals” section of Microchip’s [Designing with Low-Dropout Voltage Regulators](#) handbook.

MIC5317

5.0 TYPICAL APPLICATION SCHEMATICS

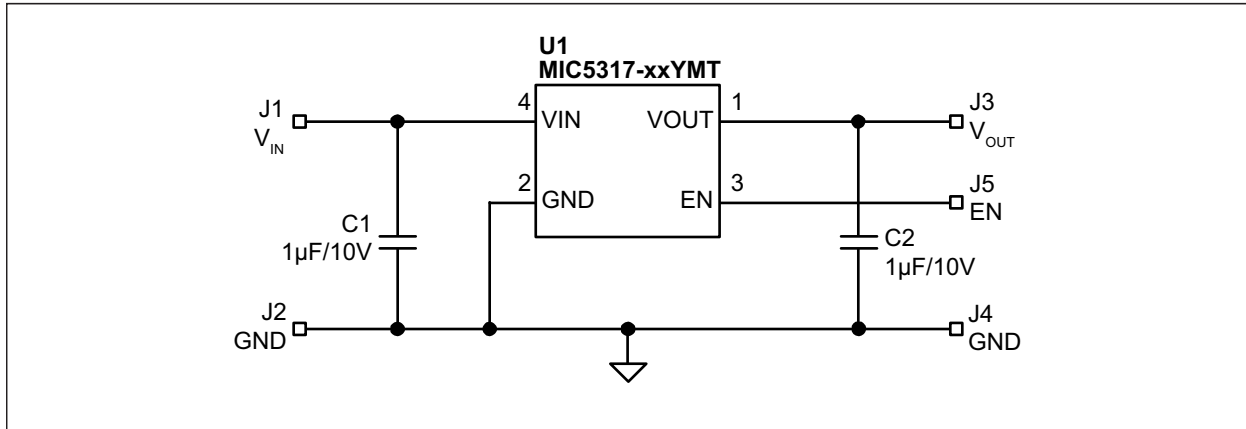

FIGURE 5-1: MIC5317-x.xYMT Typical Application Schematic.

TABLE 5-1: BILL OF MATERIALS

Item	Part Number	Manufacturer	Description	Qty.
C1, C2	GRM155R61A105KE15D	Murata	Capacitor, 1 µF Ceramic, 10V, X5R, Size 0402	2
U1	MIC5317-x.xYMT	Microchip	High-Performance Single 150 mA LDO	1

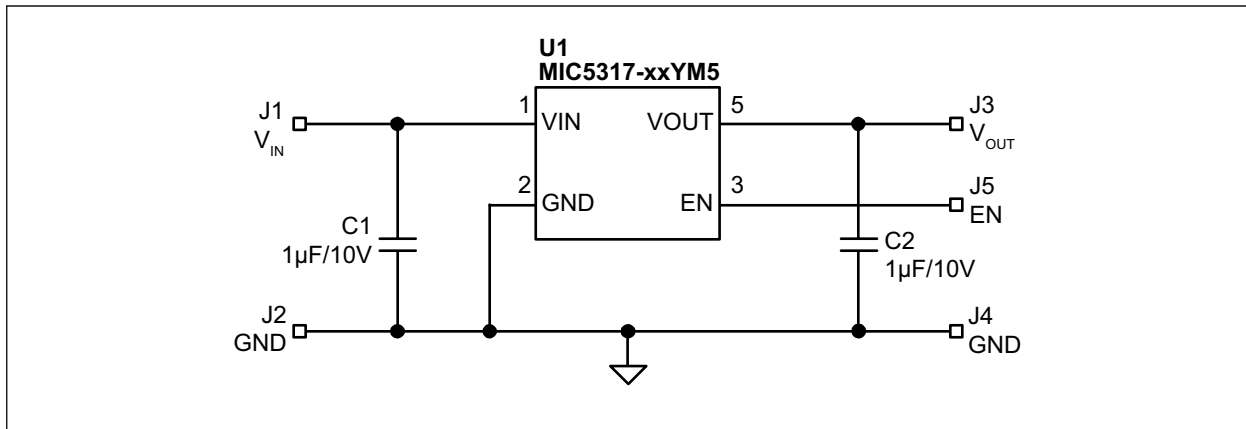

FIGURE 5-2: MIC5317-x.xYM5/YD5 Typical Application Schematic.

TABLE 5-2: BILL OF MATERIALS

Item	Part Number	Manufacturer	Description	Qty.
C1, C2	C1005X5R1A105K	TDK	Capacitor, 1 µF Ceramic, 10V, X5R, Size 0402	2
U1	MIC5317-x.xYM5/YD5	Microchip	High-Performance Single 150 mA LDO	1

6.0 PCB LAYOUT RECOMMENDATIONS

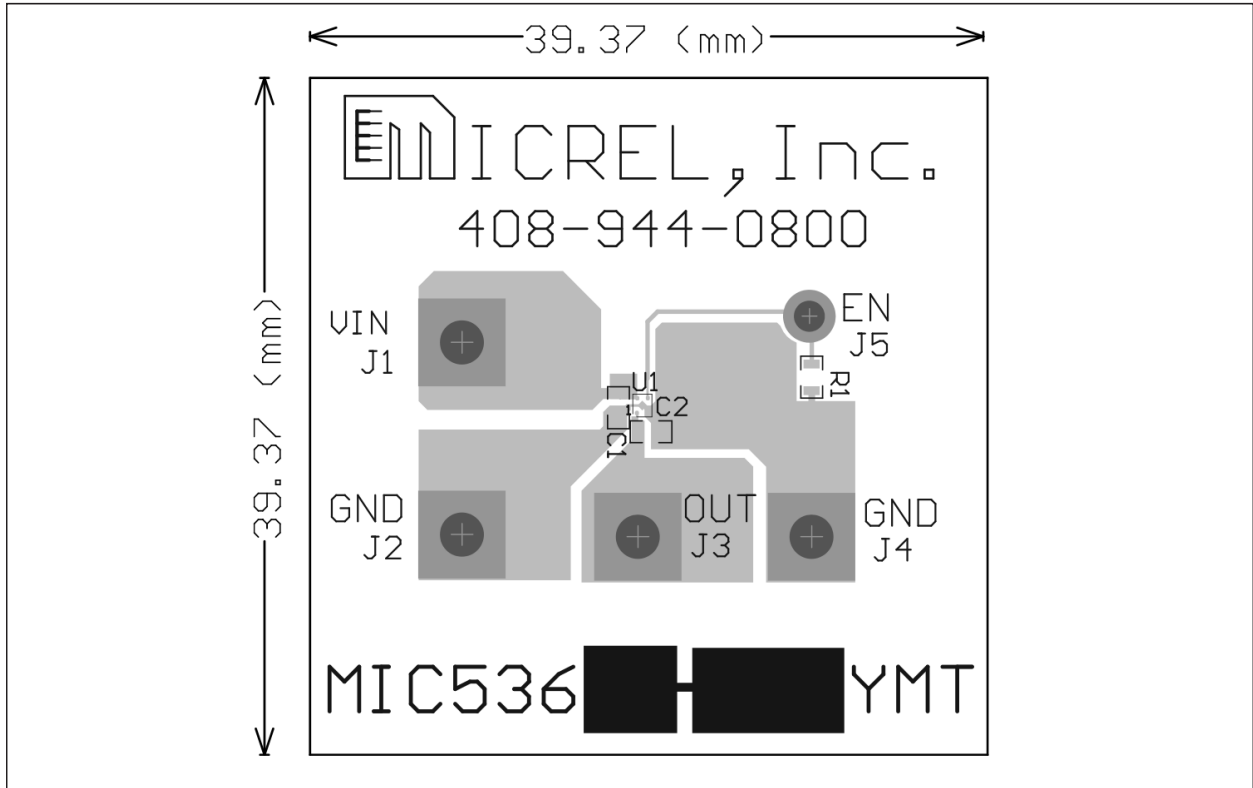

FIGURE 6-1: Top Layer.

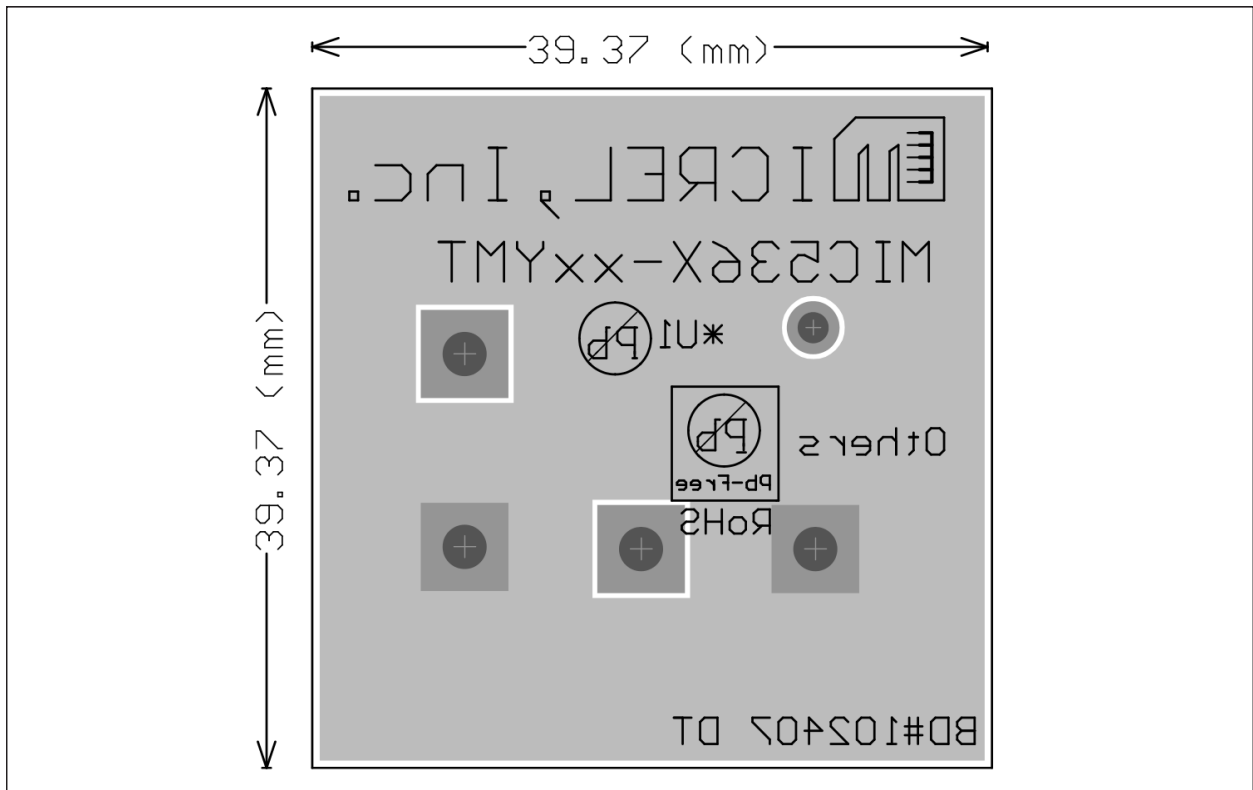

FIGURE 6-2: Bottom Layer.

MIC5317

7.0 PACKAGING INFORMATION

7.1 Package Marking Information

4-Lead UDFN*

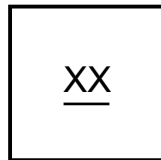

Example

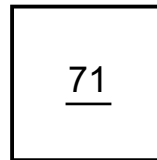

SOT23-5*

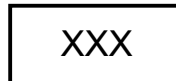

Example

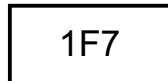

TSOT23-5*



Example

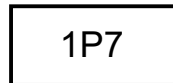

Legend:	XX...X	Product code or customer-specific information
	Y	Year code (last digit of calendar year)
	YY	Year code (last 2 digits of calendar year)
	WW	Week code (week of January 1 is week '01')
	NNN	Alphanumeric traceability code
	(e3)	Pb-free JEDEC® designator for Matte Tin (Sn)
	*	This package is Pb-free. The Pb-free JEDEC designator (e3) can be found on the outer packaging for this package.
	•, ▲, ▼	Pin one index is identified by a dot, delta up, or delta down (triangle mark).
Note:	In the event the full Microchip part number cannot be marked on one line, it will be carried over to the next line, thus limiting the number of available characters for customer-specific information. Package may or may not include the corporate logo.	
	Underbar (_) and/or Overbar (¯) symbol may not be to scale.	

TABLE 7-1: MARKING CODES

Part Number	Marking Code	Output Voltage
MIC5317-1.0YMT	71	1.0V
MIC5317-1.2YMT	72	1.2V
MIC5317-1.5YMT	73	1.5V
MIC5317-1.8YMT	74	1.8V
MIC5317-2.5YMT	76	2.5V
MIC5317-2.8YMT	77	2.8V
MIC5317-3.0YMT	78	3.0V

TABLE 7-1: MARKING CODES (CONTINUED)

Part Number	Marking Code	Output Voltage
MIC5317-3.3YMT	79	3.3V
MIC5317-1.0YM5	1C7	1.0V
MIC5317-1.2YM5	147	1.2V
MIC5317-1.5YM5	1F7	1.5V
MIC5317-1.8YM5	1G7	1.8V
MIC5317-2.5YM5	1J7	2.5V
MIC5317-2.8YM5	1M7	2.8V
MIC5317-3.0YM5	1P7	3.0V
MIC5317-3.3YM5	1S7	3.3V
MIC5317-1.0YD5	1C7	1.0V
MIC5317-1.2YD5	147	1.2V
MIC5317-1.5YD5	1F7	1.5V
MIC5317-1.8YD5	1G7	1.8V
MIC5317-2.5YD5	1J7	2.5V
MIC5317-2.8YD5	1M7	2.8V
MIC5317-3.0YD5	1P7	3.0V
MIC5317-3.3YD5	1S7	3.3V

MIC5317

4-Lead 1 mm x 1 mm UDFN Package Outline & Recommended Land Pattern

4-Lead Ultra Thin Plastic Dual Flat, No Lead Package (HCA) - 1x1 mm Body [UDFN]

Note: For the most current package drawings, please see the Microchip Packaging Specification located at <http://www.microchip.com/packaging>

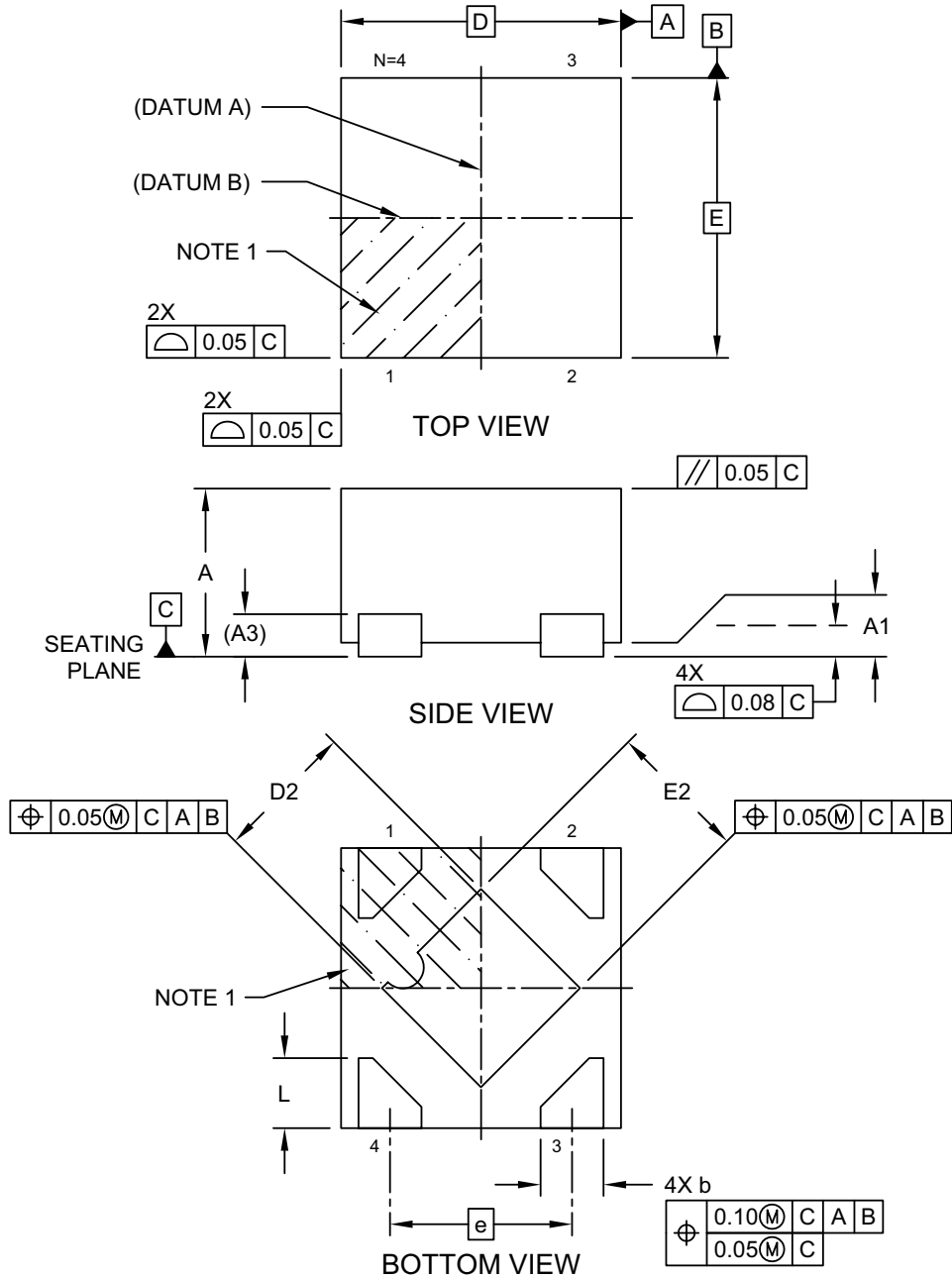

Microchip Technology Drawing C04-1149 Rev A Sheet 1 of 2

4-Lead Ultra Thin Plastic Dual Flat, No Lead Package (HCA) - 1x1 mm Body [UDFN]

Note: For the most current package drawings, please see the Microchip Packaging Specification located at <http://www.microchip.com/packaging>

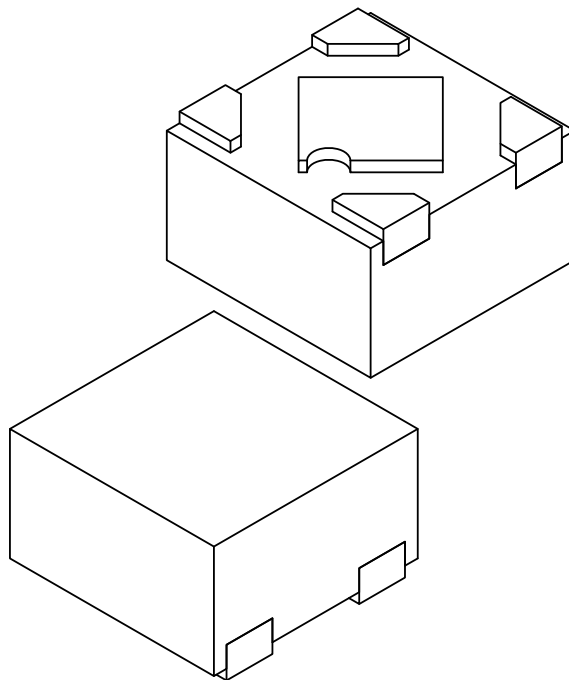

Dimension Limits	Units	MILLIMETERS		
		MIN	NOM	MAX
Number of Terminals	N	4		
Pitch	e	0.65 BSC		
Overall Height	A	0.50	0.55	0.60
Standoff	A1	0.00	0.02	0.05
Terminal Thickness	A3	0.152 REF		
Overall Length	D	1.00 BSC		
Exposed Pad Length	D2	0.45	0.50	0.55
Overall Width	E	1.00 BSC		
Exposed Pad Width	E2	0.45	0.50	0.55
Terminal Width	b	0.175	0.225	0.275
Terminal Length	L	0.20	0.25	0.30

Notes:

- Pin 1 visual index feature may vary, but must be located within the hatched area.
- Package is saw singulated
- Dimensioning and tolerancing per ASME Y14.5M
 BSC: Basic Dimension. Theoretically exact value shown without tolerances.
 REF: Reference Dimension, usually without tolerance, for information purposes only.

Microchip Technology Drawing C04-1149 Rev A Sheet 2 of 2

4-Lead Ultra Thin Plastic Dual Flat, No Lead Package (HCA) - 1x1 mm Body [UDFN]

Note: For the most current package drawings, please see the Microchip Packaging Specification located at <http://www.microchip.com/packaging>

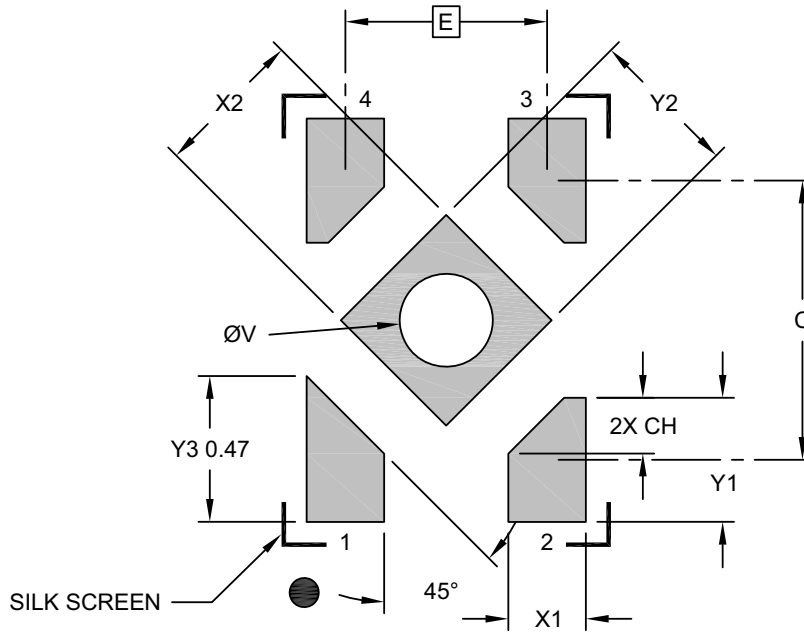

RECOMMENDED LAND PATTERN

Dimension Limits	Units	MILLIMETERS		
		MIN	NOM	MAX
Contact Pitch	E	0.65 BSC		
Center Pad Width	X2			0.48
Center Pad Length	Y2			0.48
Contact Pad Spacing	C		0.90	
Contact Pad Width (X4)	X1			0.25
Contact Pad Length (X3)	Y1			0.40
Terminal 1 Pad Length	Y3			0.47
Contact Pad Chamfer (X3)	CH		0.18	
Thermal Via Diameter	V		0.30	

Notes:

1. Dimensioning and tolerancing per ASME Y14.5M
BSC: Basic Dimension. Theoretically exact value shown without tolerances.
2. For best soldering results, thermal vias, if used, should be filled or tented to avoid solder loss during reflow process

Microchip Technology Drawing C04-3149 Rev A

5-Lead SOT23 Package Outline and Recommended Land Pattern

TITLE

5 LEAD SOT23 PACKAGE OUTLINE & RECOMMENDED LAND PATTERN

DRAWING #	SOT23-5LD-PL-1	UNIT	MM
-----------	----------------	------	----

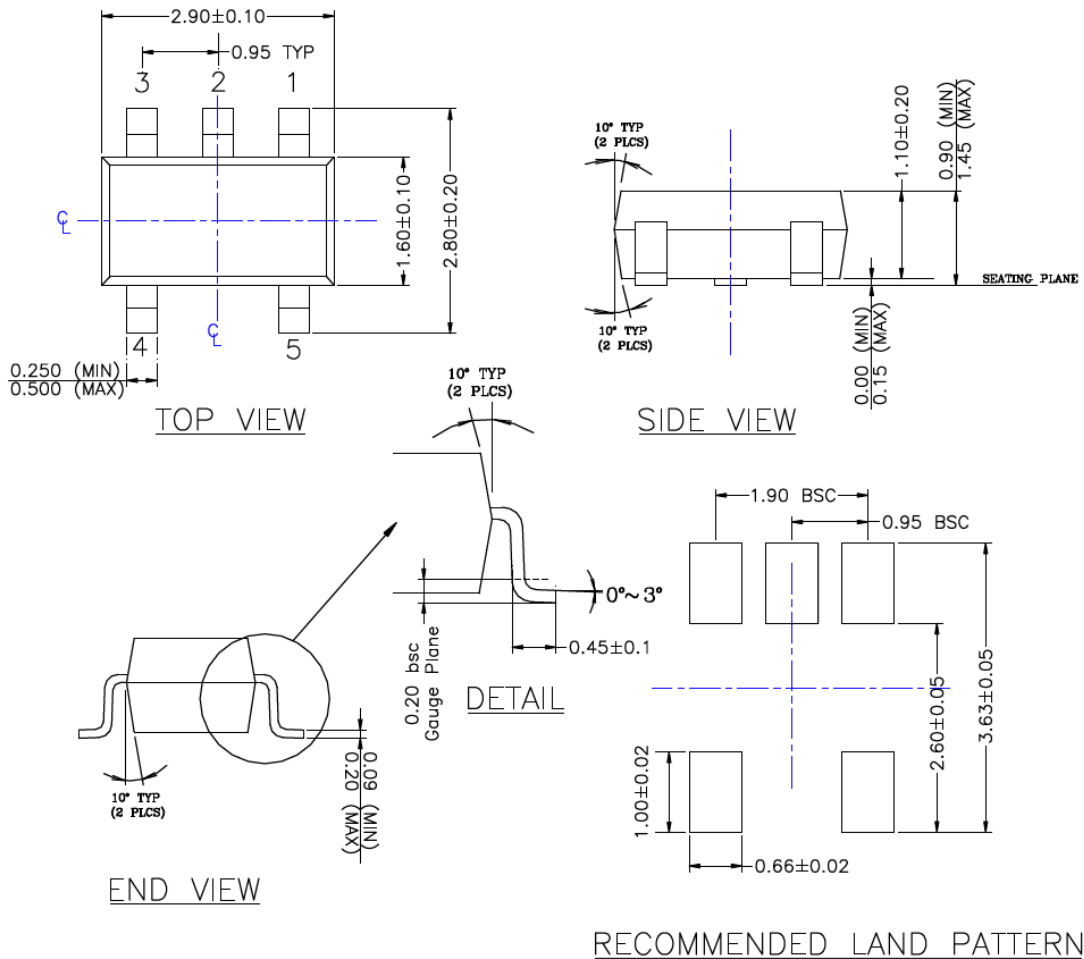

- NOTE:
1. PACKAGE OUTLINE EXCLUSIVE OF MOLD FLASH & BURR.
 2. PACKAGE OUTLINE INCLUSIVE OF SOLER PLATING.
 3. DIMENSION AND TOLERANCE PER ANSI Y14.5M, 1982.
 4. FOOT LENGTH MEASUREMENT BASED ON GAUGE PLANE METHOD.
 5. DIE FACES UP FOR MOLD, AND FACES DOWN FOR TRIM/FORM.
 6. ALL DIMENSIONS ARE IN MILLIMETERS.

Note: For the most current package drawings, please see the Microchip Packaging Specification located at <http://www.microchip.com/packaging>.

MIC5317

5-Lead TSOT23 Package Outline and Recommended Land Pattern

5-Lead Plastic Thin Small Outline Transistor (D5A) [TSOT] Micrel Legacy Package TSOT-5LD-PL-1

Note: For the most current package drawings, please see the Microchip Packaging Specification located at <http://www.microchip.com/packaging>

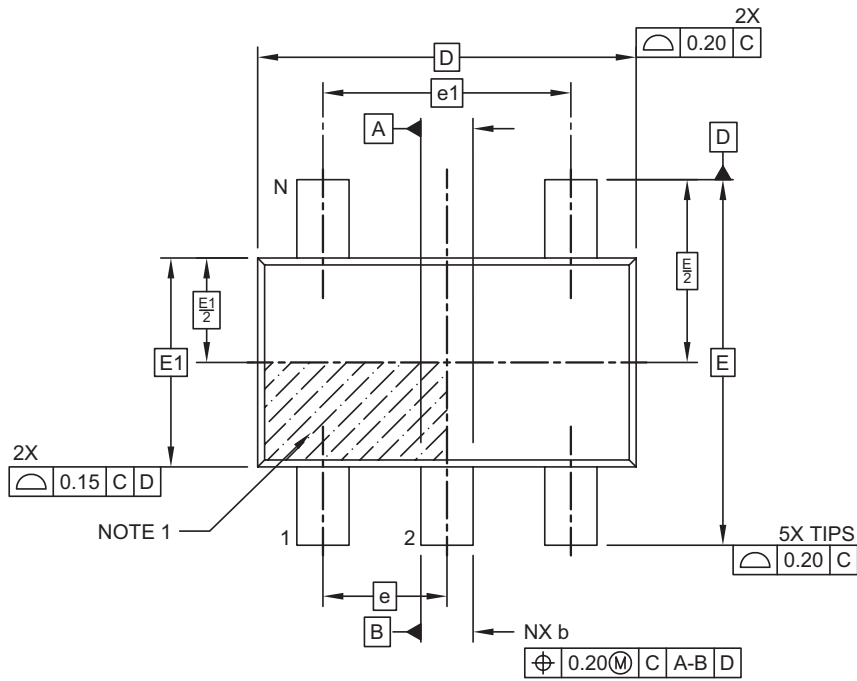

TOP VIEW

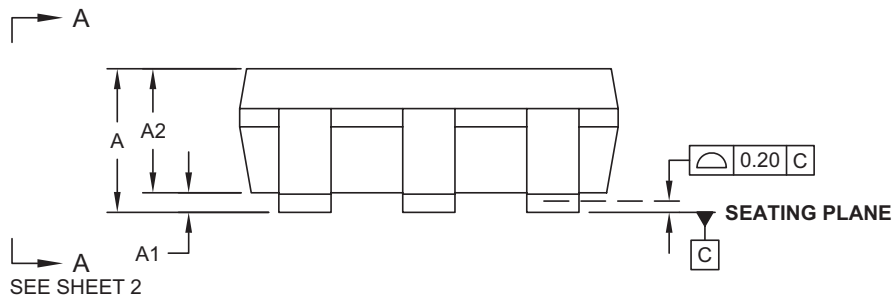

SIDE VIEW

Microchip Technology Drawing C04-1179 Rev A Sheet 1 of 2

5-Lead Plastic Thin Small Outline Transistor (D5A) [TSOT] Micrel Legacy Package TSOT-5LD-PL-1

Note: For the most current package drawings, please see the Microchip Packaging Specification located at <http://www.microchip.com/packaging>

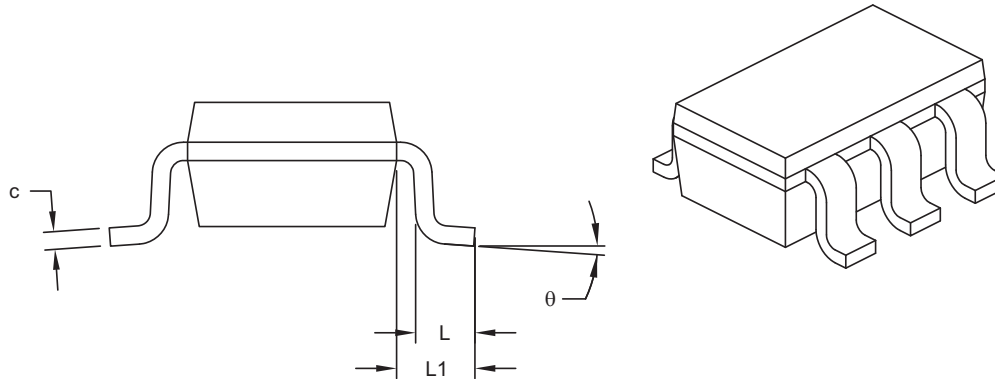

VIEW A-A
SHEET 1

Dimension Limits	Units	MILLIMETERS		
		MIN	NOM	MAX
Number of Leads	N	5		
Pitch	e	0.95 BSC		
Outside lead pitch	e1	1.90 BSC		
Overall Height	A	-	-	1.00
Molded Package Thickness	A2	0.84	0.87	0.90
Standoff	A1	0.00	-	0.10
Overall Width	E	2.80 BSC		
Molded Package Width	E1	1.60 BSC		
Overall Length	D	2.90 BSC		
Foot Length	L	0.30	0.40	0.50
Footprint	L1	0.60 REF		
Foot Angle	ϕ	0°	-	4°
Lead Thickness	c	0.127 REF		
Lead Width	b	0.30	-	0.50

Notes:

- Dimensions D and E1 do not include mold flash or protrusions. Mold flash or protrusions shall not exceed 0.25mm per side.
- Dimensioning and tolerancing per ASME Y14.5M
BSC: Basic Dimension. Theoretically exact value shown without tolerances.
REF: Reference Dimension, usually without tolerance, for information purposes only.

Microchip Technology Drawing C04-1179 Rev A Sheet 1 of 2

5-Lead Plastic Thin Small Outline Transistor (D5A) [TSOT] Micrel Legacy Package TSOT-5LD-PL-1

Note: For the most current package drawings, please see the Microchip Packaging Specification located at <http://www.microchip.com/packaging>

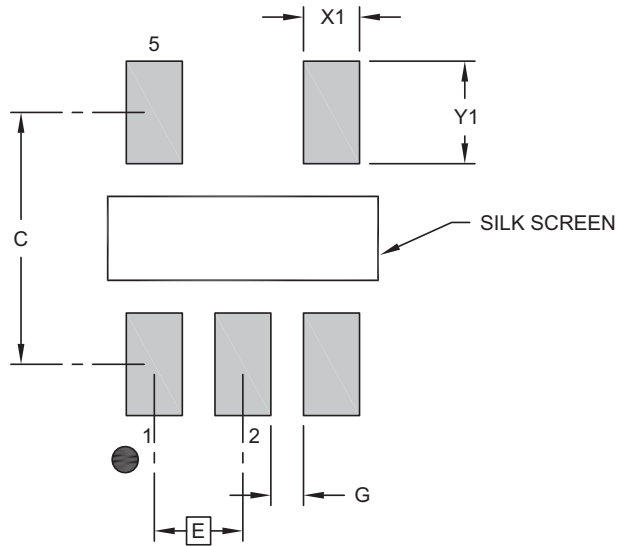

RECOMMENDED LAND PATTERN

Dimension Limits	Units	MILLIMETERS		
		MIN	NOM	MAX
Contact Pitch	E	0.95 BSC		
Contact Pad Spacing	C		2.60	
Contact Pad Width (X5)	X1			0.60
Contact Pad Length (X5)	Y1			1.10
Contact Pad to Center Pad (X2)	G	0.20		

Notes:

1. Dimensioning and tolerancing per ASME Y14.5M
BSC: Basic Dimension. Theoretically exact value shown without tolerances.

Microchip Technology Drawing C04-3179 Rev A

APPENDIX A: REVISION HISTORY

Revision A (April 2019)

- Converted Micrel document MIC5317 to Microchip data sheet template DS20006195A.
- Minor grammatical text changes throughout.

MIC5317

NOTES:

PRODUCT IDENTIFICATION SYSTEM

To order or obtain information, e.g., on pricing or delivery, contact your local Microchip representative or sales office.

Device	-X.X	X	XX	-XX
Part No.		Junction Temp. Range	Package	Media Type
Device:	MIC5317:	High Performance Single 150mA LDO		
Output Voltage:		1.0 = 1.0V 1.2 = 1.2V 1.5 = 1.5V 1.8 = 1.8V 2.5 = 2.5V 2.8 = 2.8V 3.0 = 3.0V 3.3 = 3.3V		
Junction Temperature Range:	Y =	-40°C to +125°C, RoHS-Compliant		
Package:		MT = 4-Lead 1 mm x 1 mm UDFN M5 = 5-Lead SOT23 D5 = 5-Lead Thin SOT23		
Media Type:		TR = 3,000/Reel TZ = 10,000/Reel (MT Package Option Only)		
Examples:				
a) MIC5317-1.0YMT-TR: MIC5317, 1.0V Output Voltage, -40°C to +125°C Temperature Range, 4-Lead 1 mm x 1 mm UDFN, 3,000/Reel				
b) MIC5317-1.5YM5-TR: MIC5317, 1.5V Output Voltage, -40°C to +125°C Temperature Range, 5-Lead SOT23, 3,000/Reel				
c) MIC5317-2.5YD5-TR: MIC5317, 2.5V Output Voltage, -40°C to +125°C Temperature Range, 5-Lead Thin SOT23, 3,000/Reel				
d) MIC5317-2.8YMT-TZ: MIC5317, 2.8V Output Voltage, -40°C to +125°C Temperature Range, 4-Lead 1 mm x 1 mm UDFN, 10,000/Reel				
e) MIC5317-3.0YM5-TR: MIC5317, 3.0V Output Voltage, -40°C to +125°C Temperature Range, 5-Lead SOT23, 3,000/Reel				
f) MIC5317-3.3YD5-TR: MIC5317, 3.3V Output Voltage, -40°C to +125°C Temperature Range, 5-Lead Thin SOT23, 3,000/Reel				
Note 1: Tape and Reel identifier only appears in the catalog part number description. This identifier is used for ordering purposes and is not printed on the device package. Check with your Microchip Sales Office for package availability with the Tape and Reel option.				

MIC5317

NOTES:

Note the following details of the code protection feature on Microchip devices:

- Microchip products meet the specification contained in their particular Microchip Data Sheet.
- Microchip believes that its family of products is one of the most secure families of its kind on the market today, when used in the intended manner and under normal conditions.
- There are dishonest and possibly illegal methods used to breach the code protection feature. All of these methods, to our knowledge, require using the Microchip products in a manner outside the operating specifications contained in Microchip's Data Sheets. Most likely, the person doing so is engaged in theft of intellectual property.
- Microchip is willing to work with the customer who is concerned about the integrity of their code.
- Neither Microchip nor any other semiconductor manufacturer can guarantee the security of their code. Code protection does not mean that we are guaranteeing the product as “unbreakable.”

Code protection is constantly evolving. We at Microchip are committed to continuously improving the code protection features of our products. Attempts to break Microchip's code protection feature may be a violation of the Digital Millennium Copyright Act. If such acts allow unauthorized access to your software or other copyrighted work, you may have a right to sue for relief under that Act.

Information contained in this publication regarding device applications and the like is provided only for your convenience and may be superseded by updates. It is your responsibility to ensure that your application meets with your specifications. MICROCHIP MAKES NO REPRESENTATIONS OR WARRANTIES OF ANY KIND WHETHER EXPRESS OR IMPLIED, WRITTEN OR ORAL, STATUTORY OR OTHERWISE, RELATED TO THE INFORMATION, INCLUDING BUT NOT LIMITED TO ITS CONDITION, QUALITY, PERFORMANCE, MERCHANTABILITY OR FITNESS FOR PURPOSE. Microchip disclaims all liability arising from this information and its use. Use of Microchip devices in life support and/or safety applications is entirely at the buyer's risk, and the buyer agrees to defend, indemnify and hold harmless Microchip from any and all damages, claims, suits, or expenses resulting from such use. No licenses are conveyed, implicitly or otherwise, under any Microchip intellectual property rights unless otherwise stated.

Microchip received ISO/TS-16949:2009 certification for its worldwide headquarters, design and wafer fabrication facilities in Chandler and Tempe, Arizona; Gresham, Oregon and design centers in California and India. The Company's quality system processes and procedures are for its PIC® MCUs and dsPIC® DSCs, KEELoq® code hopping devices, Serial EEPROMs, microperipherals, nonvolatile memory and analog products. In addition, Microchip's quality system for the design and manufacture of development systems is ISO 9001:2000 certified.

**QUALITY MANAGEMENT SYSTEM
CERTIFIED BY DNV
= ISO/TS 16949 =**

Trademarks

The Microchip name and logo, the Microchip logo, AnyRate, AVR, AVR logo, AVR Freaks, BitCloud, chipKIT, chipKIT logo, CryptoMemory, CryptoRF, dsPIC, FlashFlex, flexPWR, Helder, JukeBlox, KeeLoq, Klear, LANCheck, LINK MD, maXStylus, maXTouch, MediaLB, megaAVR, MOST, MOST logo, MPLAB, OptoLyzer, PIC, picoPower, PICSTART, PIC32 logo, Prochip Designer, QTouch, SAM-BA, SpyNIC, SST, SST Logo, SuperFlash, tinyAVR, UNI/O, and XMEGA are registered trademarks of Microchip Technology Incorporated in the U.S.A. and other countries.

ClockWorks, The Embedded Control Solutions Company, EtherSynch, Hyper Speed Control, HyperLight Load, IntellIMOS, mTouch, Precision Edge, and Quiet-Wire are registered trademarks of Microchip Technology Incorporated in the U.S.A.

Adjacent Key Suppression, AKS, Analog-for-the-Digital Age, Any Capacitor, AnyIn, AnyOut, BodyCom, CodeGuard, CryptoAuthentication, CryptoAutomotive, CryptoCompanion, CryptoController, dsPICDEM, dsPICDEM.net, Dynamic Average Matching, DAM, ECAN, EtherGREEN, In-Circuit Serial Programming, ICSP, INICnet, Inter-Chip Connectivity, JitterBlocker, KlearNet, KlearNet logo, memBrain, Mindi, MiWi, motorBench, MPASM, MPF, MPLAB Certified logo, MPLIB, MPLINK, MultiTRAK, NetDetach, Omniscient Code Generation, PICDEM, PICDEM.net, PICKit, PICtail, PowerSmart, PureSilicon, QMatrix, REAL ICE, Ripple Blocker, SAM-ICE, Serial Quad I/O, SMART-I.S., SQI, SuperSwitcher, SuperSwitcher II, Total Endurance, TSHARC, USBCheck, VariSense, ViewSpan, WiperLock, Wireless DNA, and ZENA are trademarks of Microchip Technology Incorporated in the U.S.A. and other countries.

SQTP is a service mark of Microchip Technology Incorporated in the U.S.A.

Silicon Storage Technology is a registered trademark of Microchip Technology Inc. in other countries.

GestIC is a registered trademark of Microchip Technology Germany II GmbH & Co. KG, a subsidiary of Microchip Technology Inc., in other countries.

All other trademarks mentioned herein are property of their respective companies.

© 2019, Microchip Technology Incorporated, All Rights Reserved.
ISBN: 978-1-5224-4426-8



MICROCHIP

Worldwide Sales and Service

AMERICAS

Corporate Office
2355 West Chandler Blvd.
Chandler, AZ 85224-6199
Tel: 480-792-7200
Fax: 480-792-7277
Technical Support:
<http://www.microchip.com/support>
Web Address:
www.microchip.com

Atlanta

Duluth, GA
Tel: 678-957-9614
Fax: 678-957-1455

Austin, TX

Tel: 512-257-3370

Boston

Westborough, MA
Tel: 774-760-0087
Fax: 774-760-0088

Chicago

Itasca, IL
Tel: 630-285-0071
Fax: 630-285-0075

Dallas

Addison, TX
Tel: 972-818-7423
Fax: 972-818-2924

Detroit

Novi, MI
Tel: 248-848-4000

Houston, TX

Tel: 281-894-5983

Indianapolis

Noblesville, IN
Tel: 317-773-8323
Fax: 317-773-5453
Tel: 317-536-2380

Los Angeles

Mission Viejo, CA
Tel: 949-462-9523
Fax: 949-462-9608
Tel: 951-273-7800

Raleigh, NC

Tel: 919-844-7510

New York, NY

Tel: 631-435-6000

San Jose, CA

Tel: 408-735-9110
Tel: 408-436-4270

Canada - Toronto

Tel: 905-695-1980
Fax: 905-695-2078

ASIA/PACIFIC

Australia - Sydney
Tel: 61-2-9868-6733

China - Beijing
Tel: 86-10-8569-7000

China - Chengdu
Tel: 86-28-8665-5511

China - Chongqing
Tel: 86-23-8980-9588

China - Dongguan
Tel: 86-769-8702-9880

China - Guangzhou
Tel: 86-20-8755-8029

China - Hangzhou
Tel: 86-571-8792-8115

China - Hong Kong SAR
Tel: 852-2943-5100

China - Nanjing
Tel: 86-25-8473-2460

China - Qingdao
Tel: 86-532-8502-7355

China - Shanghai
Tel: 86-21-3326-8000

China - Shenyang
Tel: 86-24-2334-2829

China - Shenzhen
Tel: 86-755-8864-2200

China - Suzhou
Tel: 86-186-6233-1526

China - Wuhan
Tel: 86-27-5980-5300

China - Xian
Tel: 86-29-8833-7252

China - Xiamen
Tel: 86-592-2388138

China - Zhuhai
Tel: 86-756-3210040

ASIA/PACIFIC

India - Bangalore
Tel: 91-80-3090-4444

India - New Delhi
Tel: 91-11-4160-8631

India - Pune
Tel: 91-20-4121-0141

Japan - Osaka
Tel: 81-6-6152-7160

Japan - Tokyo
Tel: 81-3-6880-3770

Korea - Daegu
Tel: 82-53-744-4301

Korea - Seoul
Tel: 82-2-554-7200

Malaysia - Kuala Lumpur
Tel: 60-3-7651-7906

Malaysia - Penang
Tel: 60-4-227-8870

Philippines - Manila
Tel: 63-2-634-9065

Singapore
Tel: 65-6334-8870

Taiwan - Hsin Chu
Tel: 886-3-577-8366

Taiwan - Kaohsiung
Tel: 886-7-213-7830

Taiwan - Taipei
Tel: 886-2-2508-8600

Thailand - Bangkok
Tel: 66-2-694-1351

Vietnam - Ho Chi Minh
Tel: 84-28-5448-2100

EUROPE

Austria - Wels
Tel: 43-7242-2244-39
Fax: 43-7242-2244-393

Denmark - Copenhagen
Tel: 45-4450-2828
Fax: 45-4485-2829

Finland - Espoo
Tel: 358-9-4520-820

France - Paris
Tel: 33-1-69-53-63-20
Fax: 33-1-69-30-90-79

Germany - Garching
Tel: 49-8931-9700

Germany - Haan
Tel: 49-2129-3766400

Germany - Heilbronn
Tel: 49-7131-67-3636

Germany - Karlsruhe
Tel: 49-721-625370

Germany - Munich
Tel: 49-89-627-144-0
Fax: 49-89-627-144-44

Germany - Rosenheim
Tel: 49-8031-354-560

Israel - Ra'anana
Tel: 972-9-744-7705

Italy - Milan
Tel: 39-0331-742611
Fax: 39-0331-466781

Italy - Padova
Tel: 39-049-7625286

Netherlands - Drunen
Tel: 31-416-690399
Fax: 31-416-690340

Norway - Trondheim
Tel: 47-7288-4388

Poland - Warsaw
Tel: 48-22-3325737

Romania - Bucharest
Tel: 40-21-407-87-50

Spain - Madrid
Tel: 34-91-708-08-90
Fax: 34-91-708-08-91

Sweden - Gothenberg
Tel: 46-31-704-60-40

Sweden - Stockholm
Tel: 46-8-5090-4654

UK - Wokingham
Tel: 44-118-921-5800
Fax: 44-118-921-5820

Looking for pricing, stock, or lifecycle information?

Click below to explore more details on WIN SOURCE:

- ⊖ [View MIC5317-2.5YM5-T5 on WIN SOURCE](#)
- ⊖ [Microchip Technology](#) Information

Optimize Your Supply Chain with WIN SOURCE Solutions

- ✓ Global Sourcing Solution
- ✓ Obsolete Management
- ✓ Cost Control Management
- ✓ Shortage Management
- ✓ Alternative Solution
- ✓ Excess Inventory Management