



**THE DATASHEET OF  
DXT5551P5-13**





**DXT5551P5**

**160V NPN HIGH VOLTAGE TRANSISTOR  
PowerDI<sup>®</sup>5**

**Features and Benefits**

- 43% smaller than SOT223; 60% smaller than TO252
- Maximum height just 1.1mm
- Rated up to 2.25W
- $BV_{CEO} > 160V$
- $I_{C(cont)} = 0.6A$
- **Lead Free, RoHS Compliant (Note 1)**
- **Halogen and Antimony Free, "Green" Device (Note 2)**
- **Qualified to AEC-Q101 Standards for High Reliability**

**Mechanical Data**

- Case: PowerDI<sup>®</sup>5
- Case Material: Molded Plastic, "Green" Molding Compound. UL Flammability Classification Rating 94V-0
- Moisture Sensitivity: Level 1 per J-STD-020
- Terminals: Finish – Matte Tin annealed over Copper leadframe. Solderable per MIL-STD-202, Method 208 ③
- Weight: 0.093 grams (approximate)

**Applications**

- Telecom line driver

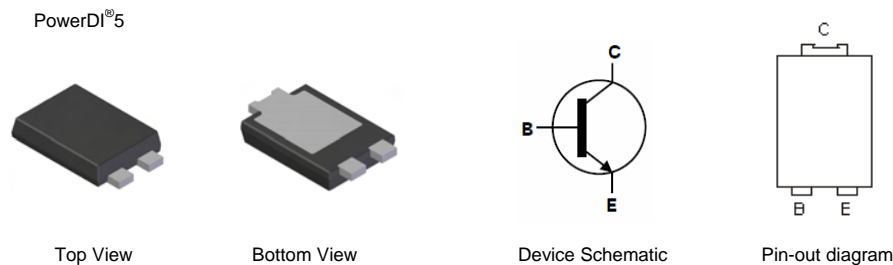

**Ordering Information** (Note 3)

Product	Marking	Reel size (inches)	Tape width (mm)	Quantity per reel
DXT5551P5-13	DXT5551	13	16	5,000

- Notes:
1. No purposefully added lead.
  2. Halogen and Antimony Free. Diodes Inc's "Green" Policy can be found on our website at <http://www.diodes.com>
  3. For packaging details, go to our website at <http://www.diodes.com>

**Marking Information**

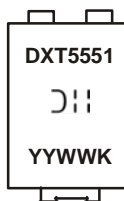

DXT5551 = Product Type Marking Code  
 D||| = Manufacturers' Code Marking  
 K = Factory Designator  
 YYWW = Date Code Marking  
 YY = Last Two Digits of Year (ex: 09 for 2009)  
 WW = Week code (01 - 53)

**Maximum Ratings** @ $T_A = 25^\circ\text{C}$  unless otherwise specified

Characteristic	Symbol	Value	Unit
Collector-Base Voltage	$V_{CB0}$	180	V
Collector-Emitter Voltage	$V_{CEO}$	160	V
Emitter-Base Voltage	$V_{EBO}$	6	V
Continuous Collector Current	$I_C$	600	mA

**Thermal Characteristics** @ $T_A = 25^\circ\text{C}$  unless otherwise specified

Characteristic	Symbol	Value	Unit
Power Dissipation (Note 4)	$P_D$	2.25	W
Thermal Resistance, Junction to Ambient Air (Note 4)	$R_{\theta JA}$	55.5	$^\circ\text{C/W}$
Power Dissipation (Note 5)	$P_D$	1.28	W
Thermal Resistance, Junction to Ambient Air (Note 5)	$R_{\theta JA}$	97.4	$^\circ\text{C/W}$
Power Dissipation (Note 6)	$P_D$	0.7	W
Thermal Resistance, Junction to Ambient Air (Note 6)	$R_{\theta JA}$	179	$^\circ\text{C/W}$
Thermal Resistance, Junction to Collector Terminal	$R_{\theta JT}$	30	$^\circ\text{C/W}$
Operating and Storage Temperature Range	$T_J, T_{STG}$	-55 to +150	$^\circ\text{C}$

- Notes:
4. Device mounted on 1.6mm FR-4 PCB, single sided 2 oz. copper, collector pad dimensions 50mm x 50mm.
  5. Device mounted on 1.6mm FR-4 PCB, single sided 1 oz. copper, collector pad dimensions 25mm x 25mm.
  6. Device mounted on 1.6mm FR-4 PCB, single sided 1 oz. copper, minimum recommended pad layout.

**Thermal Characteristics**

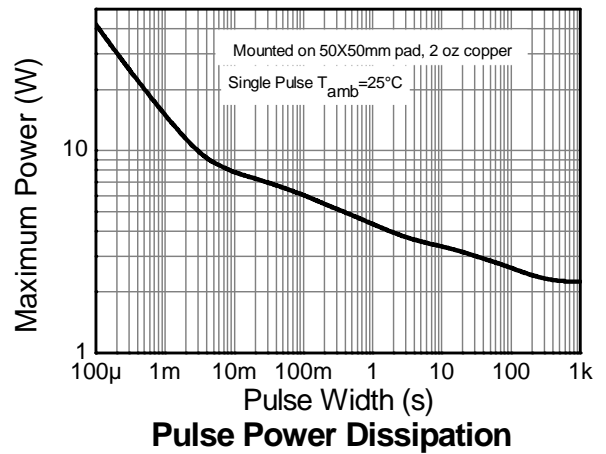
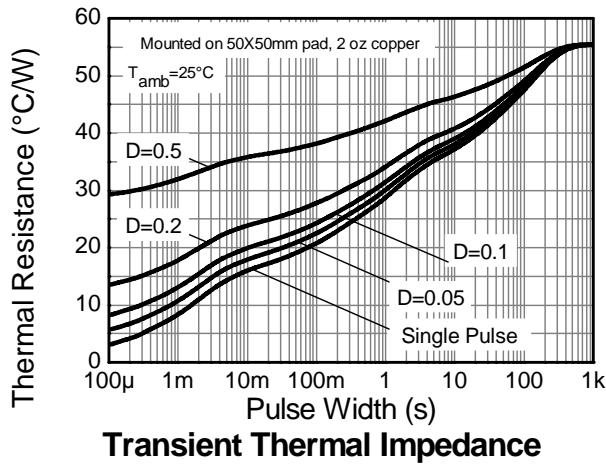
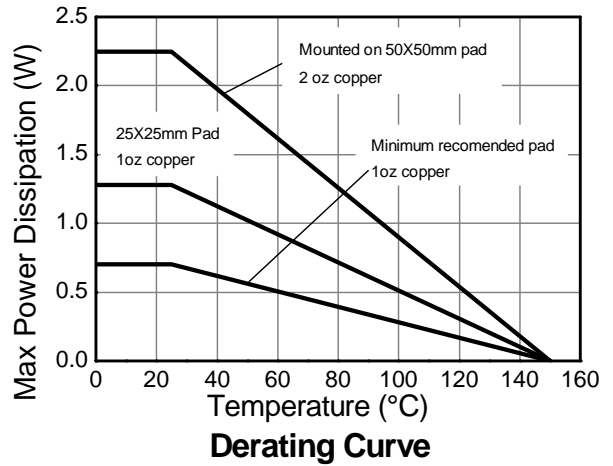
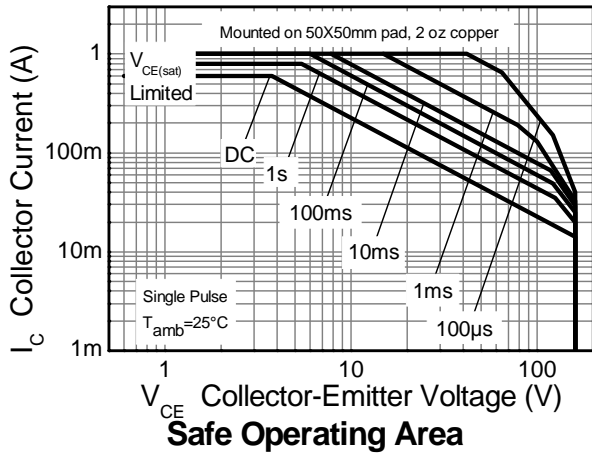

**Electrical Characteristics** @T<sub>A</sub> = 25°C unless otherwise specified

Characteristic	Symbol	Min	Typ	Max	Unit	Test Condition
Collector-Base Breakdown Voltage	BV <sub>CBO</sub>	180	270	–	V	I <sub>C</sub> = 100μA
Collector-Emitter Breakdown Voltage (Note 7)	BV <sub>CEO</sub>	160	200	–	V	I <sub>C</sub> = 1mA
Emitter-Base Breakdown Voltage	BV <sub>EBO</sub>	6.0	7.85	–	V	I <sub>E</sub> = 10μA
Collector Cutoff Current	I <sub>CBO</sub>	–	<1	50	nA	V <sub>CB</sub> = 120V
		–	–	50	μA	V <sub>CB</sub> = 120V, T <sub>A</sub> = 100°C
Collector-Emitter Saturation Voltage (Note 7)	V <sub>CE(sat)</sub>	–	65	150	mV	I <sub>C</sub> = 10mA, I <sub>B</sub> = 1mA
		–	115	200	mV	I <sub>C</sub> = 50mA, I <sub>B</sub> = 5mA
Base-Emitter Saturation Voltage (Note 7)	V <sub>BE(sat)</sub>	–	760	1000	mV	I <sub>C</sub> = 10mA, I <sub>B</sub> = 1mA
		–	840	1200	mV	I <sub>C</sub> = 50mA, I <sub>B</sub> = 5mA
DC Current Gain (Note 7)	h <sub>FE</sub>	80	130	–	–	V <sub>CE</sub> = 5V, I <sub>C</sub> = 1mA
		80	145	250	–	V <sub>CE</sub> = 5V, I <sub>C</sub> = 10mA
		30	65	–	–	V <sub>CE</sub> = 5V, I <sub>C</sub> = 50mA
Transition Frequency	f <sub>T</sub>	–	130	–	MHz	V <sub>CE</sub> = 10V, I <sub>C</sub> = 10mA, f = 100MHz
Output Capacitance (Note 7)	C <sub>obo</sub>	–	–	6	pF	V <sub>CB</sub> = 10V, f = 1MHz
Delay Time	t <sub>(d)</sub>	–	95	–	ns	V <sub>CC</sub> = 510V, I <sub>C</sub> = 10mA, I <sub>B1</sub> = I <sub>B2</sub> = 1mA
Rise Time	t <sub>(r)</sub>	–	64	–	ns	
Storage Time	t <sub>(s)</sub>	–	1256	–	ns	
Delay Time	t <sub>(f)</sub>	–	140	–	ns	

Notes: 7. Pulse Test: Pulse width ≤300μs. Duty cycle ≤2.0%.

**Typical Characteristics**

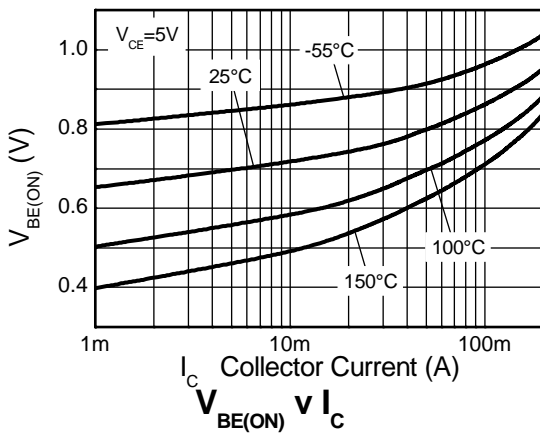
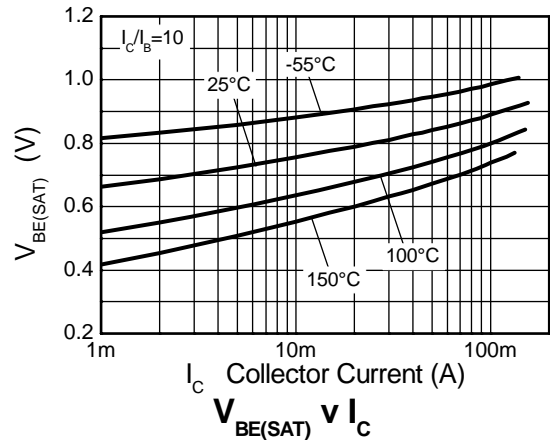
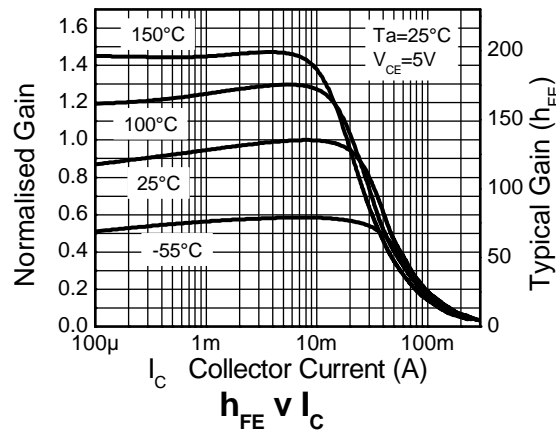
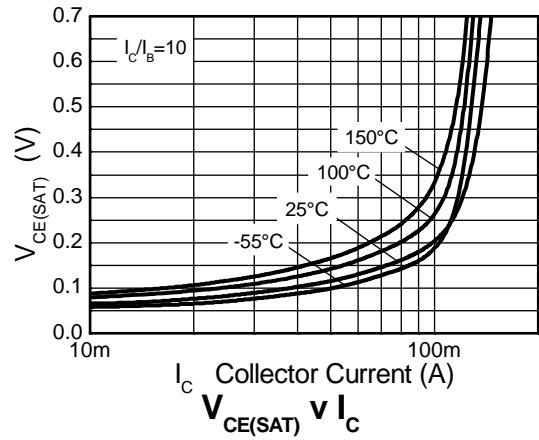
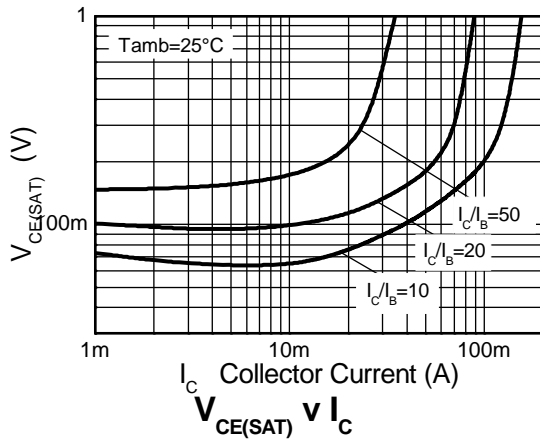

**Package Outline Dimensions**

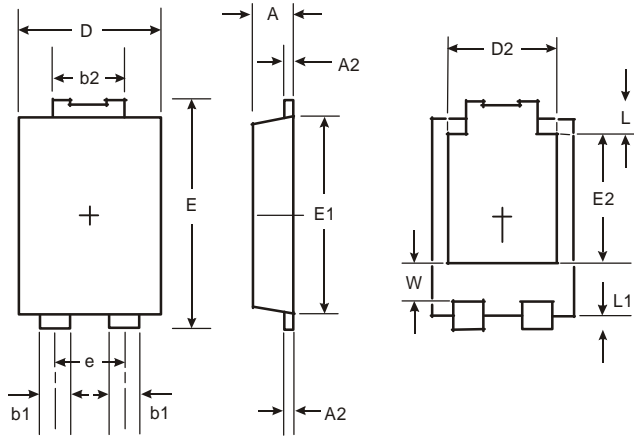

PowerDI <sup>®</sup> 5		
Dim	Min	Max
A	1.05	1.15
A2	0.33	0.43
b1	0.80	0.99
b2	1.70	1.88
D	3.90	4.05
D2	3.054 Typ	
E	6.40	6.60
e	1.84 Typ	
E1	5.30	5.45
E2	3.549 Typ	
L	0.75	0.95
L1	0.50	0.65
W	1.10	1.41
All Dimensions in mm		

**Suggested Pad Layout**

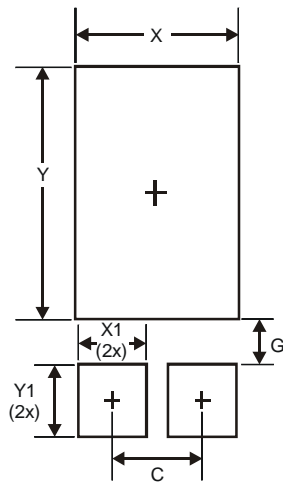

Dimensions	Value (in mm)
C	1.840
G	0.852
X	3.360
X1	1.390
Y	4.860
Y1	1.400

#### IMPORTANT NOTICE

DIODES INCORPORATED MAKES NO WARRANTY OF ANY KIND, EXPRESS OR IMPLIED, WITH REGARDS TO THIS DOCUMENT, INCLUDING, BUT NOT LIMITED TO, THE IMPLIED WARRANTIES OF MERCHANTABILITY AND FITNESS FOR A PARTICULAR PURPOSE (AND THEIR EQUIVALENTS UNDER THE LAWS OF ANY JURISDICTION).

Diodes Incorporated and its subsidiaries reserve the right to make modifications, enhancements, improvements, corrections or other changes without further notice to this document and any product described herein. Diodes Incorporated does not assume any liability arising out of the application or use of this document or any product described herein; neither does Diodes Incorporated convey any license under its patent or trademark rights, nor the rights of others. Any Customer or user of this document or products described herein in such applications shall assume all risks of such use and will agree to hold Diodes Incorporated and all the companies whose products are represented on Diodes Incorporated website, harmless against all damages.

Diodes Incorporated does not warrant or accept any liability whatsoever in respect of any products purchased through unauthorized sales channel. Should Customers purchase or use Diodes Incorporated products for any unintended or unauthorized application, Customers shall indemnify and hold Diodes Incorporated and its representatives harmless against all claims, damages, expenses, and attorney fees arising out of, directly or indirectly, any claim of personal injury or death associated with such unintended or unauthorized application.

Products described herein may be covered by one or more United States, international or foreign patents pending. Product names and markings noted herein may also be covered by one or more United States, international or foreign trademarks.

#### LIFE SUPPORT

Diodes Incorporated products are specifically not authorized for use as critical components in life support devices or systems without the express written approval of the Chief Executive Officer of Diodes Incorporated. As used herein:

A. Life support devices or systems are devices or systems which:

1. are intended to implant into the body, or
2. support or sustain life and whose failure to perform when properly used in accordance with instructions for use provided in the labeling can be reasonably expected to result in significant injury to the user.

B. A critical component is any component in a life support device or system whose failure to perform can be reasonably expected to cause the failure of the life support device or to affect its safety or effectiveness.

Customers represent that they have all necessary expertise in the safety and regulatory ramifications of their life support devices or systems, and acknowledge and agree that they are solely responsible for all legal, regulatory and safety-related requirements concerning their products and any use of Diodes Incorporated products in such safety-critical, life support devices or systems, notwithstanding any devices- or systems-related information or support that may be provided by Diodes Incorporated. Further, Customers must fully indemnify Diodes Incorporated and its representatives against any damages arising out of the use of Diodes Incorporated products in such safety-critical, life support devices or systems.

Copyright © 2010, Diodes Incorporated

[www.diodes.com](http://www.diodes.com)

## Looking for pricing, stock, or lifecycle information?

Click below to explore more details on WIN SOURCE:

 [View DXT5551P5-13 on WIN SOURCE](#)

 [Diodes Incorporated](#) Information

## Optimize Your Supply Chain with WIN SOURCE Solutions

-  Global Sourcing Solution
-  Obsolete Management
-  Cost Control Management
-  Shortage Management
-  Alternative Solution
-  Excess Inventory Management