



**THE DATASHEET OF  
TPS22930AYZVR**



## TPS22930 Ultra Small, Low On-Resistance Load Switch With Controlled Turn-on

### 1 Features

- Integrated Single Channel Load Switch
- Ultra Small Four Terminal Wafer-Chip-Scale Package (Nominal Dimensions Shown, See Addendum for Details)
  - 0.9 mm × 0.9 mm, 0.5 mm Pitch, 0.5 mm Height (YZV)
- Input Voltage Range: 1.4 V to 5.5 V
- Ultra Low  $R_{ON}$  Resistance
  - $R_{ON} = 35\text{ m}\Omega$  at  $V_{IN} = 5\text{ V}$
  - $R_{ON} = 36\text{ m}\Omega$  at  $V_{IN} = 3.6\text{ V}$
  - $R_{ON} = 49\text{ m}\Omega$  at  $V_{IN} = 1.8\text{ V}$
- 2 A Maximum Continuous Switch Current
- Low Quiescent Current ( $< 3\text{ }\mu\text{A}$ )
- Low Control Input Threshold Enables Use of 1.2 V/1.8 V/2.5 V/3.3 V Logic
- Controlled Slew Rate
- Under Voltage Lockout
- Reverse Current Protection When Disabled

### 2 Applications

- Smartphone / Wireless Handsets
- Portable Industrial / Medical Equipment
- Portable Media Players
- Point of Sales Terminals
- GPS Navigation Devices
- Digital Cameras
- Portable Instrumentation

### 4 Simplified Schematic

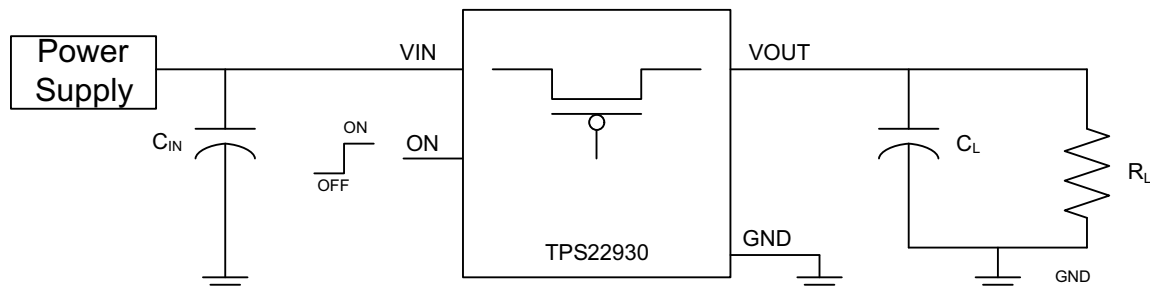

### 3 Description

The TPS22930 is a small, low  $R_{ON}$  load switch with controlled turn on. The device contains a P-channel MOSFET that can operate over an input voltage range of 1.4 V to 5.5 V. The switch is controlled by an on/off input (ON), which is capable of interfacing directly with low-voltage control signals. The TPS22930 is active high enable.

The TPS22930 device provides circuit breaker functionality by disabling the body diode during reverse voltage (also known as reverse current) situations. Reverse current protection is active only when the power-switch is disabled (off). The device disengages the body diode when the output voltage ( $V_{OUT}$ ) is driven higher than the input ( $V_{IN}$ ) to stop the flow of current towards the input side of the switch. Additionally, under-voltage lockout (UVLO) protection turns the switch off if the input voltage is too low.

The slew rate of the device is internally controlled in order to avoid inrush current.

The TPS22930 is available in an ultra-small, space-saving 4-pin CSP package and is characterized for operation over the free-air temperature range of  $-40^{\circ}\text{C}$  to  $85^{\circ}\text{C}$ .

#### Device Information<sup>(1)</sup>

PART NUMBER	PACKAGE	BODY SIZE (MAX)
TPS22930	DSBGA (4)	0.92 mm × 0.92 mm

(1) For all available packages, see the orderable addendum at the end of the data sheet.



## Table of Contents

<b>1 Features</b> .....	<b>1</b>	9.2 Functional Block Diagram .....	<b>12</b>
<b>2 Applications</b> .....	<b>1</b>	9.3 Feature Description .....	<b>12</b>
<b>3 Description</b> .....	<b>1</b>	9.4 Device Functional Modes .....	<b>13</b>
<b>4 Simplified Schematic</b> .....	<b>1</b>	<b>10 Application and Implementation</b> .....	<b>14</b>
<b>5 Revision History</b> .....	<b>2</b>	10.1 Application Information .....	<b>14</b>
<b>6 Pin Configuration and Functions</b> .....	<b>3</b>	10.2 Typical Application .....	<b>14</b>
<b>7 Specifications</b> .....	<b>3</b>	<b>11 Power Supply Recommendations</b> .....	<b>15</b>
7.1 Absolute Maximum Ratings .....	<b>3</b>	<b>12 Layout</b> .....	<b>15</b>
7.2 ESD Ratings .....	<b>4</b>	12.1 Layout Guidelines .....	<b>15</b>
7.3 Recommended Operating Conditions .....	<b>4</b>	12.2 Layout Example .....	<b>16</b>
7.4 Thermal Information .....	<b>4</b>	12.3 Thermal Considerations .....	<b>16</b>
7.5 Electrical Characteristics .....	<b>5</b>	<b>13 Device and Documentation Support</b> .....	<b>17</b>
7.6 Switching Characteristics .....	<b>6</b>	13.1 Community Resources .....	<b>17</b>
7.7 Typical Characteristics .....	<b>6</b>	13.2 Trademarks .....	<b>17</b>
<b>8 Parameter Measurement Information</b> .....	<b>11</b>	13.3 Electrostatic Discharge Caution .....	<b>17</b>
<b>9 Detailed Description</b> .....	<b>12</b>	13.4 Glossary .....	<b>17</b>
9.1 Overview .....	<b>12</b>	<b>14 Mechanical, Packaging, and Orderable Information</b> .....	<b>17</b>

## 5 Revision History

### Changes from Revision A (June 2015) to Revision B Page

- Made changes to [Pin Configuration and Functions](#) .....

**1**

### Changes from Original (November 2012) to Revision A Page

- Removed Ordering Information table. ....
- Added ESD Ratings table, Feature Description section, Device Functional Modes, Application and Implementation section, Power Supply Recommendations section, Layout section, Device and Documentation Support section, and Mechanical, Packaging, and Orderable Information section. ....

**1**

**1**

## 6 Pin Configuration and Functions

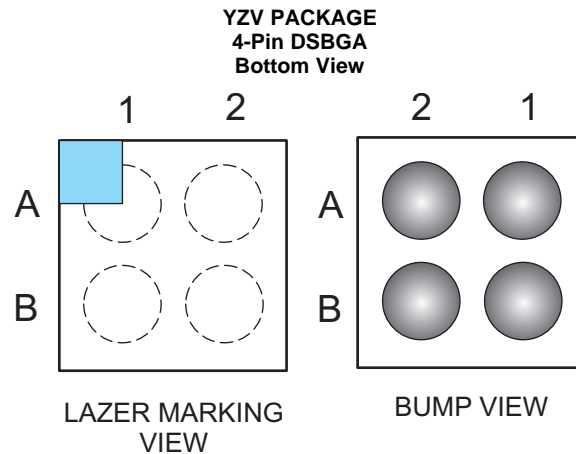

### Pin Assignments

<b>A</b>	VOUT	VIN
<b>B</b>	GND	ON
	<b>1</b>	<b>2</b>

### Pin Functions

PIN		I/O	DESCRIPTION
NO.	NAME		
A1	VOUT	O	Switch output.
A2	VIN	I	Switch input. Input bypass capacitor recommended for minimizing $V_{IN}$ dip during transients.
B1	GND	–	Device ground.
B2	ON	I	Switch control input, active high. Do not leave floating.

## 7 Specifications

### 7.1 Absolute Maximum Ratings

over operating free-air temperature range (unless otherwise noted)<sup>(1)(2)</sup>

		MIN	MAX	UNIT
$V_{IN}$	Input voltage	–0.3	6	V
$V_{OUT}$	Output voltage	–0.3	6	V
$V_{ON}$	Input voltage	–0.3	6	V
$I_{MAX}$	Maximum continuous switch current		2	A
$I_{PLS}$	Maximum pulsed switch current, pulse $\leq 1$ ms, 25% duty cycle		2.5	A
$T_A$	Operating free-air temperature <sup>(3)</sup>	–40	85	°C
$T_J$	Maximum junction temperature		150	°C
$T_{stg}$	Storage temperature	–65	150	°C

- (1) Stresses beyond those listed under *Absolute Maximum Ratings* may cause permanent damage to the device. These are stress ratings only, and functional operation of the device at these or any other conditions beyond those indicated under *Recommended Operating Conditions* is not implied. Exposure to absolute-maximum-rated conditions for extended periods may affect device reliability.
- (2) All voltage values are with respect to network ground terminal.
- (3) In applications where high power dissipation and/or poor package thermal resistance is present, the maximum ambient temperature may have to be derated. Maximum ambient temperature  $[T_{A(max)}]$  is dependent on the maximum operating junction temperature  $[T_{J(max)}]$ , the maximum power dissipation of the device in the application  $[P_{D(max)}]$ , and the junction-to-ambient thermal resistance of the part/package in the application ( $R_{\theta JA}$ ), as given by the following equation:  $T_{A(max)} = T_{J(max)} - (R_{\theta JA} \times P_{D(max)})$

## 7.2 ESD Ratings

		VALUE	UNIT
$V_{(ESD)}$ Electrostatic discharge	Human-body model (HBM), per ANSI/ESDA/JEDEC JS-001 <sup>(1)</sup>	±2000	V
	Charged-device model (CDM), per JEDEC specification JESD22-C101 <sup>(2)</sup>	±1000	

- (1) JEDEC document JEP155 states that 500-V HBM allows safe manufacturing with a standard ESD control process. Manufacturing with less than 500-V HBM is possible with the necessary precautions.
- (2) JEDEC document JEP157 states that 250-V CDM allows safe manufacturing with a standard ESD control process. Manufacturing with less than 250-V CDM is possible with the necessary precautions.

## 7.3 Recommended Operating Conditions

over operating free-air temperature range (unless otherwise noted)

		MIN	MAX	UNIT
$V_{IN}$	Input voltage range	1.4	5.5	V
$V_{ON}$	ON voltage range	0	5.5	V
$V_{OUT}$	Output voltage range	0	$V_{IN}$	V
$V_{IH}$	High-level input voltage, ON	$V_{IN} = 3.61\text{ V to }5.5\text{ V}$		V
		$V_{IN} = 1.4\text{ V to }3.6\text{ V}$		
$V_{IL}$	Low-level input voltage, ON	$V_{IN} = 3.61\text{ V to }5.5\text{ V}$		V
		$V_{IN} = 1.4\text{ V to }3.6\text{ V}$		
$C_{IN}$	Input capacitor	1 <sup>(1)</sup>		μF

- (1) Refer to [Application Information](#) section.

## 7.4 Thermal Information

THERMAL METRIC <sup>(1)</sup>		TPS22930	UNIT
		YZV (DSBGA)	
		4 PINS	
$R_{\theta JA}$	Junction-to-ambient thermal resistance	189.1	°C/W
$R_{\theta JC(top)}$	Junction-to-case (top) thermal resistance	1.9	°C/W
$R_{\theta JB}$	Junction-to-board thermal resistance	36.8	°C/W
$\psi_{JT}$	Junction-to-top characterization parameter	11.3	°C/W
$\psi_{JB}$	Junction-to-board characterization parameter	36.8	°C/W
$R_{\theta JC(bot)}$	Junction-to-case (bottom) thermal resistance	–	°C/W

- (1) For more information about traditional and new thermal metrics, see the *Semiconductor and IC Package Thermal Metrics* application report, [SPRA953](#).

## 7.5 Electrical Characteristics

Unless otherwise note, the specification in the following table applies over the operating ambient temperature  $-40^{\circ}\text{C} \leq T_A \leq 85^{\circ}\text{C}$  (Full). Typical values are for  $T_A = 25^{\circ}\text{C}$ .

PARAMETER		TEST CONDITIONS	$T_A$	MIN	TYP	MAX	UNIT
<b>POWER SUPPLIES AND CURRENTS</b>							
$I_{IN}$	Quiescent current	$I_{OUT} = 0\text{ V}, V_{IN} = V_{ON} = 5.25\text{ V}$	Full		2.3	10	$\mu\text{A}$
		$I_{OUT} = 0\text{ V}, V_{IN} = V_{ON} = 4.2\text{ V}$			2.2	7	
		$I_{OUT} = 0\text{ V}, V_{IN} = V_{ON} = 3.6\text{ V}$			2.1	7	
		$I_{OUT} = 0\text{ V}, V_{IN} = V_{ON} = 2.5\text{ V}$			1.0	5	
		$I_{OUT} = 0\text{ V}, V_{IN} = V_{ON} = 1.5\text{ V}$			0.8	5	
$I_{IN(off)}$	Off supply current	$V_{OUT} = \text{Open}, V_{IN} = 5.25\text{ V}, V_{ON} = 0\text{ V}$	Full		0.3	10	$\mu\text{A}$
		$V_{OUT} = \text{Open}, V_{IN} = 4.2\text{ V}, V_{ON} = 0\text{ V}$			0.2	7	
		$V_{OUT} = \text{Open}, V_{IN} = 3.6\text{ V}, V_{ON} = 0\text{ V}$			0.2	7	
		$V_{OUT} = \text{Open}, V_{IN} = 2.5\text{ V}, V_{ON} = 0\text{ V}$			0.1	5	
		$V_{OUT} = \text{Open}, V_{IN} = 1.5\text{ V}, V_{ON} = 0\text{ V}$			0.1	5	
$I_{IN(Leak)}$	Leakage current	$V_{OUT} = 0\text{ V}, V_{IN} = 5.25\text{ V}, V_{ON} = 0\text{ V}$	Full		0.8	10	$\mu\text{A}$
		$V_{OUT} = 0\text{ V}, V_{IN} = 4.2\text{ V}, V_{ON} = 0\text{ V}$			0.2	7	
		$V_{OUT} = 0\text{ V}, V_{IN} = 3.6\text{ V}, V_{ON} = 0\text{ V}$			0.2	7	
		$V_{OUT} = 0\text{ V}, V_{IN} = 2.5\text{ V}, V_{ON} = 0\text{ V}$			0.1	5	
		$V_{OUT} = 0\text{ V}, V_{IN} = 1.5\text{ V}, V_{ON} = 0\text{ V}$			0.1	5	
$I_{ON}$	ON pin input leakage current	$V_{ON} = 5.5\text{ V}$	Full			0.5	$\mu\text{A}$
$I_{RCP(Leak)}$	Reverse leakage current	$V_{IN} = V_{ON} = \text{GND}, V_{OUT} = 5\text{ V},$ measured from $V_{IN}$	Full			2	
UVLO	Undervoltage lockout	$V_{IN}$ increasing, $V_{ON} = 3.6\text{ V}, I_{OUT} = -100\text{ mA}$	Full			1.2	
		$V_{IN}$ decreasing, $V_{ON} = 3.6\text{ V}, I_{OUT} = -100\text{ mA}$			0.5		
<b>RESISTANCE CHARACTERISTICS</b>							
$R_{ON}$	ON-state resistance	$I_{OUT} = -200\text{ mA}$	$V_{IN} = 5.0\text{ V}$	25°C	35	44	$\text{m}\Omega$
				Full		50	
			$V_{IN} = 4.2\text{ V}$	25°C	35	44	
				Full		50	
			$V_{IN} = 3.6\text{ V}$	25°C	36	44	
				Full		50	
			$V_{IN} = 2.5\text{ V}$	25°C	39	44	
				Full		50	
			$V_{IN} = 1.8\text{ V}$	25°C	49	55	
				Full		62	
			$V_{IN} = 1.5\text{ V}$	25°C	59	66	
				Full		74	

### 7.6 Switching Characteristics

PARAMETER	TEST CONDITIONS	MIN	TYP	MAX	UNIT
<b>V<sub>IN</sub> = 5.5 V, T<sub>A</sub> = 25°C (unless otherwise noted)</b>					
t <sub>ON</sub> Turn-on time	R <sub>L</sub> = 10 Ω, C <sub>L</sub> = 0.1 μF		4.8		μs
t <sub>OFF</sub> Turn-off time			6.3		
t <sub>R</sub> V <sub>OUT</sub> rise time			5.6		
t <sub>F</sub> V <sub>OUT</sub> fall time			2.8		
<b>V<sub>IN</sub> = 4.2 V, T<sub>A</sub> = 25°C (unless otherwise noted)</b>					
t <sub>ON</sub> Turn-on time	R <sub>L</sub> = 10 Ω, C <sub>L</sub> = 0.1 μF		5.8		μs
t <sub>OFF</sub> Turn-off time			7.3		
t <sub>R</sub> V <sub>OUT</sub> rise time			5.4		
t <sub>F</sub> V <sub>OUT</sub> fall time			2.8		
<b>V<sub>IN</sub> = 3.0 V, T<sub>A</sub> = 25°C (unless otherwise noted)</b>					
t <sub>ON</sub> Turn-on time	R <sub>L</sub> = 10 Ω, C <sub>L</sub> = 0.1 μF		7.4		μs
t <sub>OFF</sub> Turn-off time			9.5		
t <sub>R</sub> V <sub>OUT</sub> rise time			6.3		
t <sub>F</sub> V <sub>OUT</sub> fall time			2.9		

### 7.7 Typical Characteristics

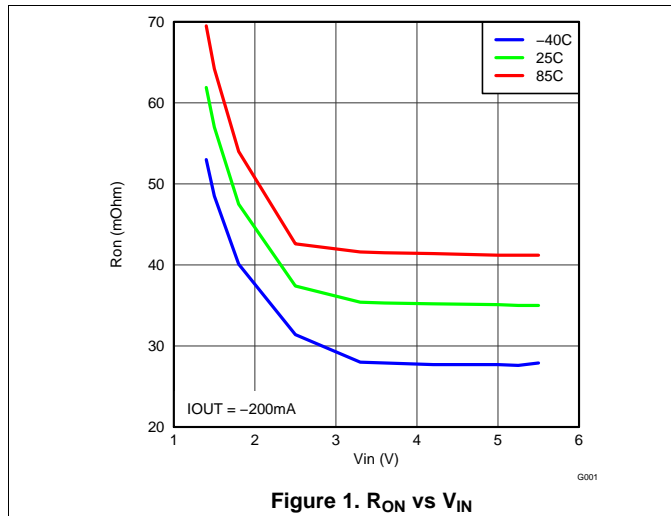

Figure 1. R<sub>ON</sub> vs V<sub>IN</sub>

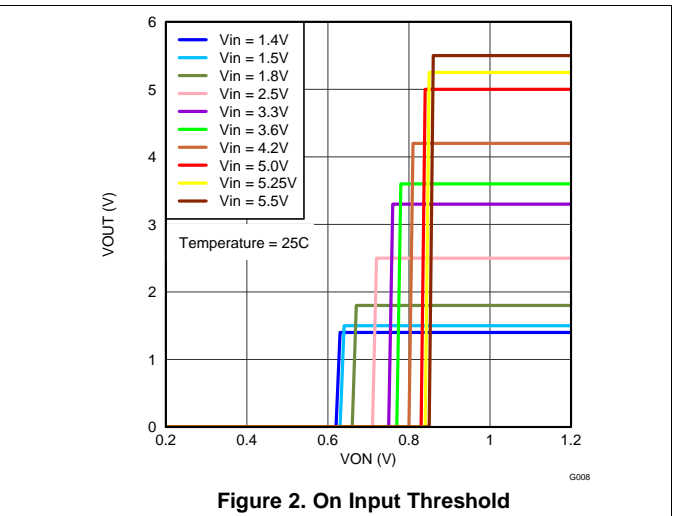

Figure 2. On Input Threshold

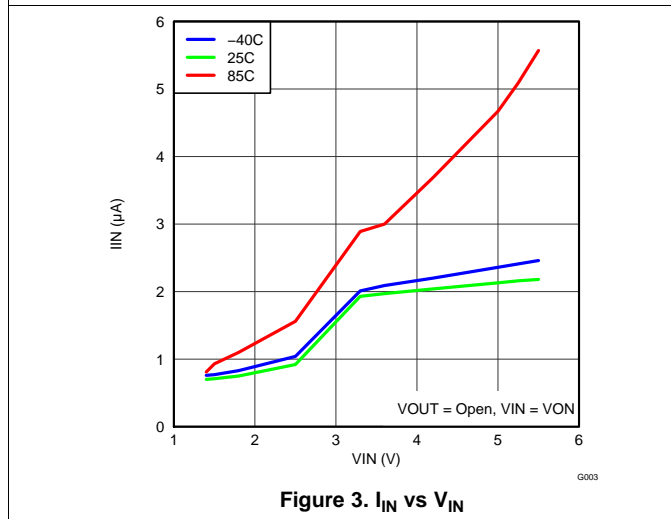

Figure 3. I<sub>IN</sub> vs V<sub>IN</sub>

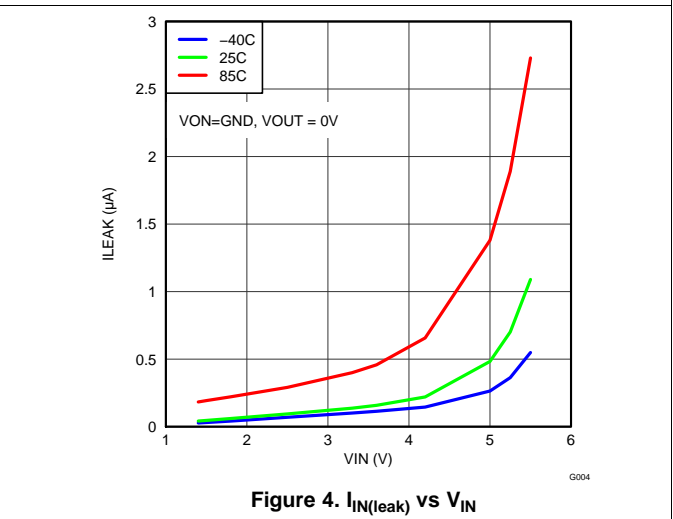
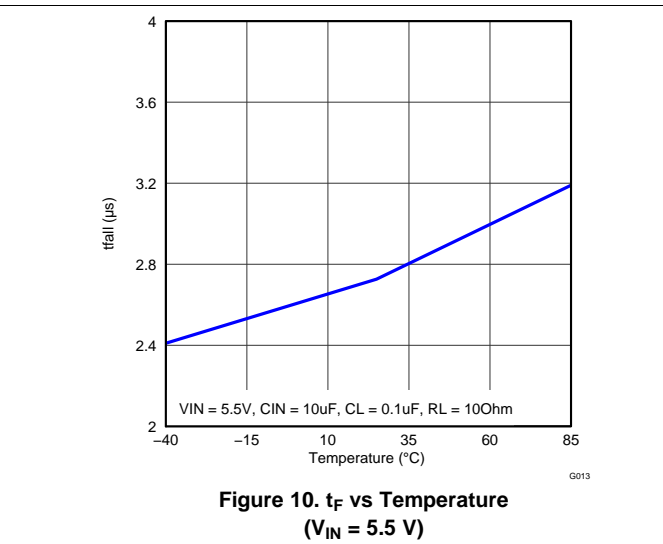
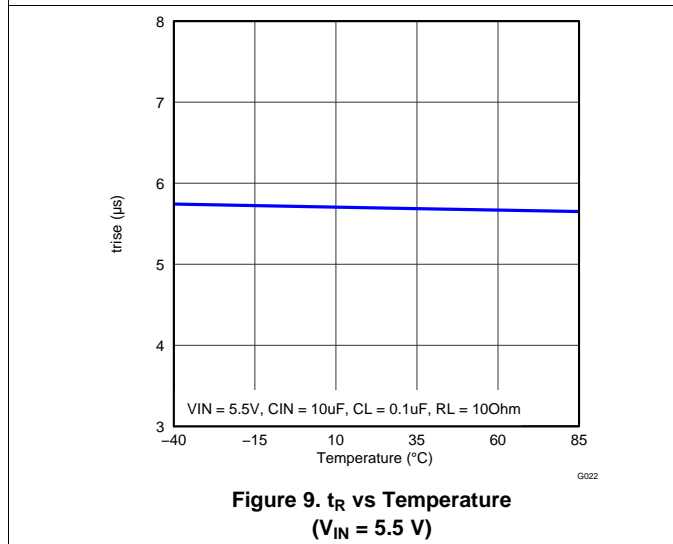
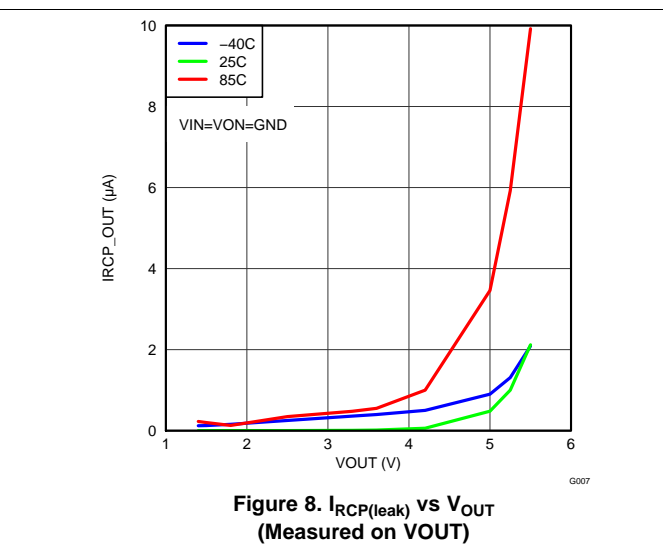
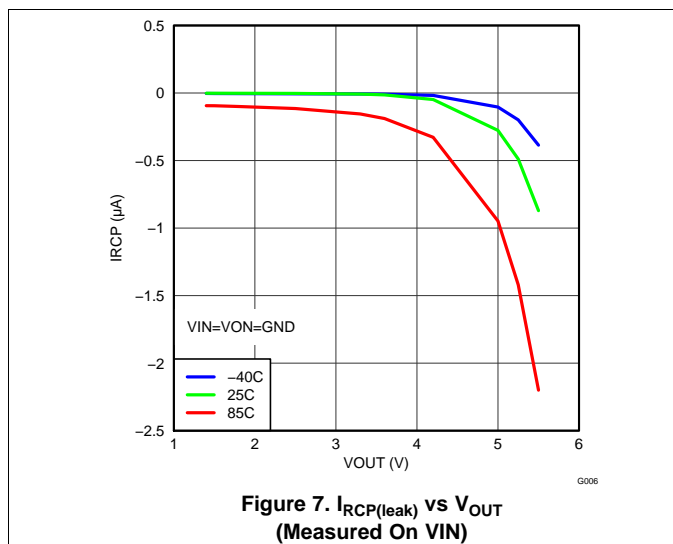
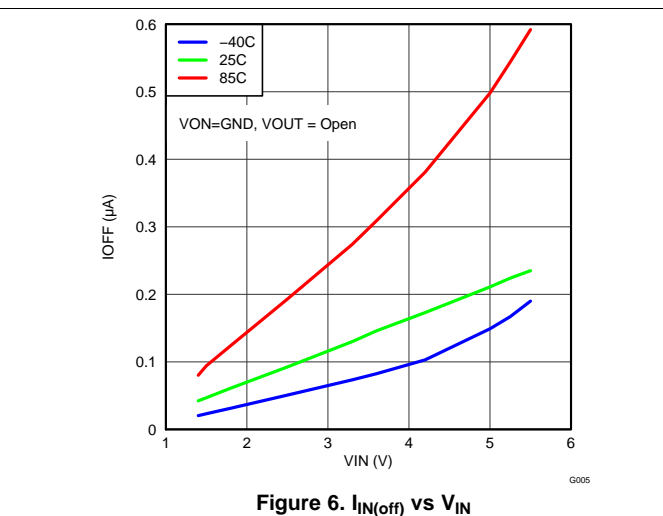
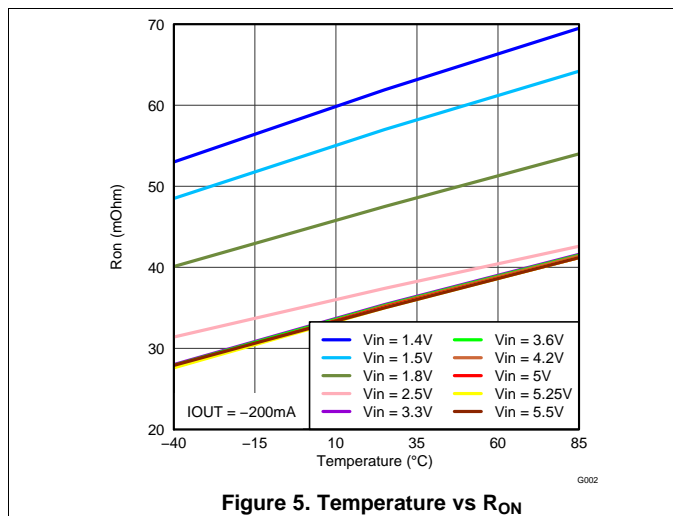
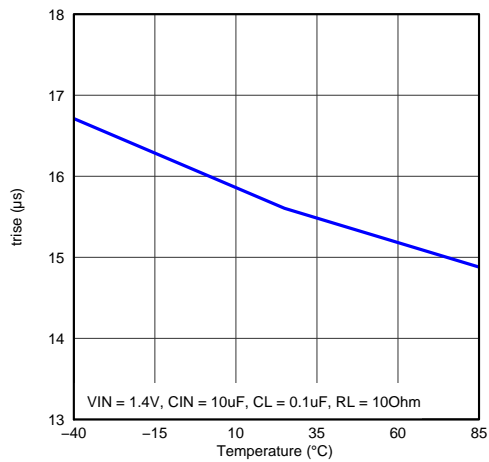
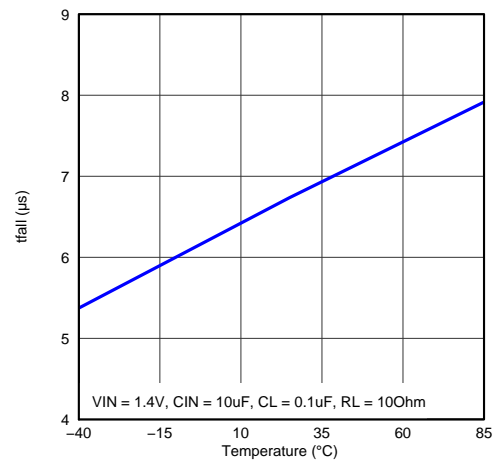
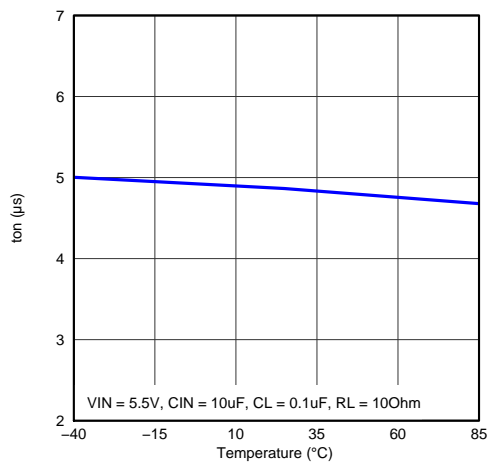
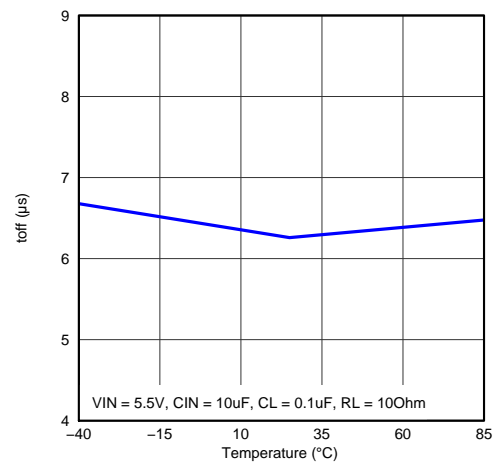
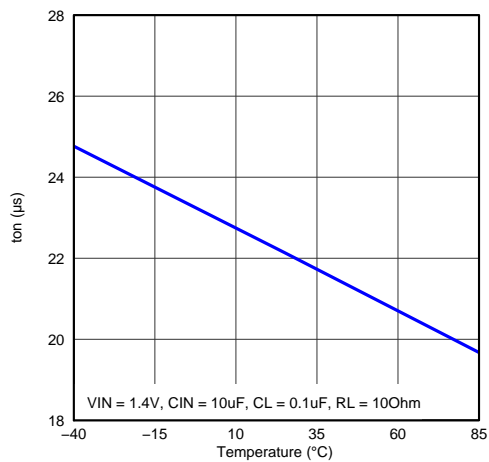
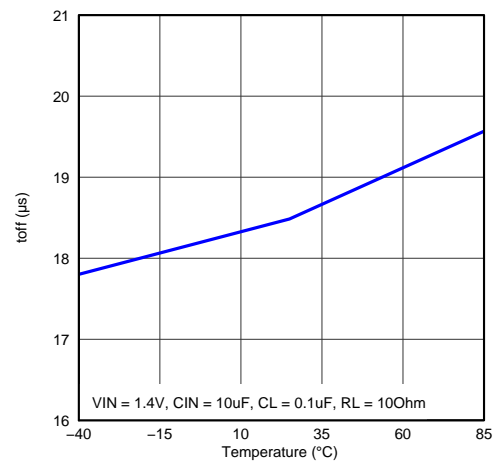

Figure 4. I<sub>IN(leak)</sub> vs V<sub>IN</sub>

Typical Characteristics (continued)



**Typical Characteristics (continued)**

**Figure 11.  $t_{R}$  vs Temperature  
( $V_{IN} = 1.4\text{ V}$ )**

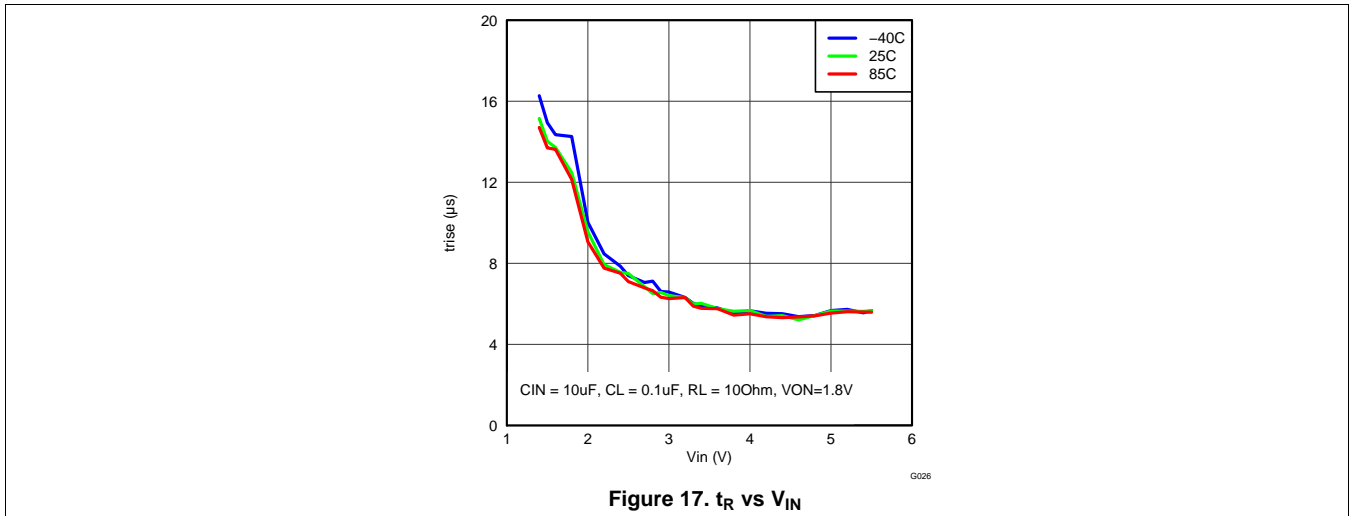
**Figure 12.  $t_{F}$  vs Temperature  
( $V_{IN} = 1.4\text{ V}$ )**

**Figure 13.  $t_{ON}$  vs Temperature  
( $V_{IN} = 5.5\text{ V}$ )**

**Figure 14.  $t_{OFF}$  vs Temperature  
( $V_{IN} = 5.5\text{ V}$ )**

**Figure 15.  $t_{ON}$  vs Temperature  
( $V_{IN} = 1.4\text{ V}$ )**

**Figure 16.  $t_{OFF}$  vs Temperature  
( $V_{IN} = 1.4\text{ V}$ )**

Typical Characteristics (continued)



7.7.1 Typical AC Scope Captures at  $T_A = 25^\circ\text{C}$

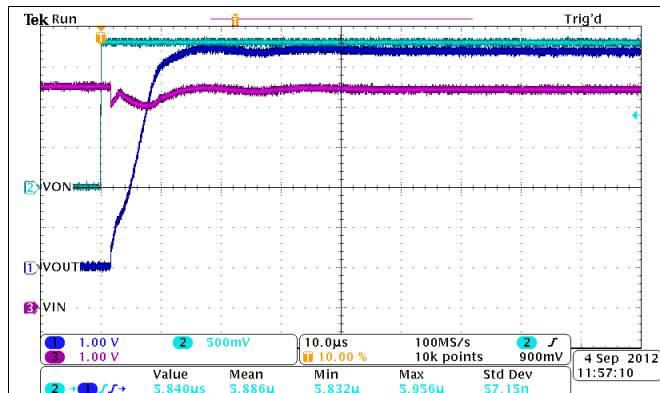

Figure 18. Turn-On Response Time  
 $(V_{IN} = 5.5\text{ V}, C_{IN} = 10\ \mu\text{F}, C_L = 1\ \mu\text{F}, R_L = 10\ \Omega)$

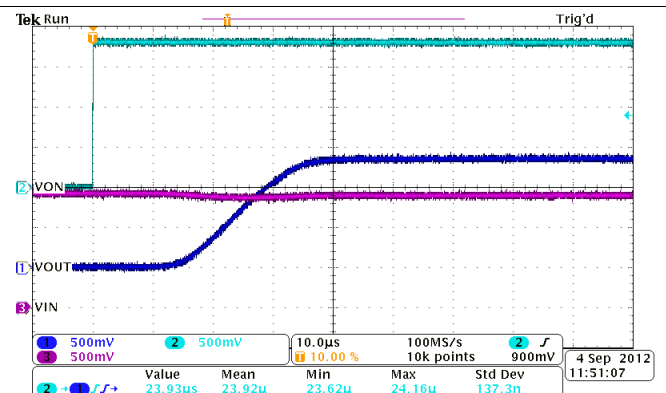

Figure 19. Turn-On Response Time  
 $(V_{IN} = 1.4\text{ V}, C_{IN} = 10\ \mu\text{F}, C_L = 1\ \mu\text{F}, R_L = 10\ \Omega)$

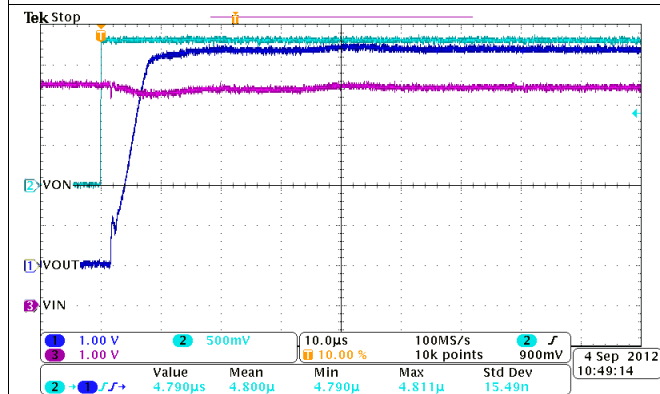

Figure 20. Turn-On Response Time  
 $(V_{IN} = 5.5\text{ V}, C_{IN} = 10\ \mu\text{F}, C_L = 0.1\ \mu\text{F}, R_L = 10\ \Omega)$

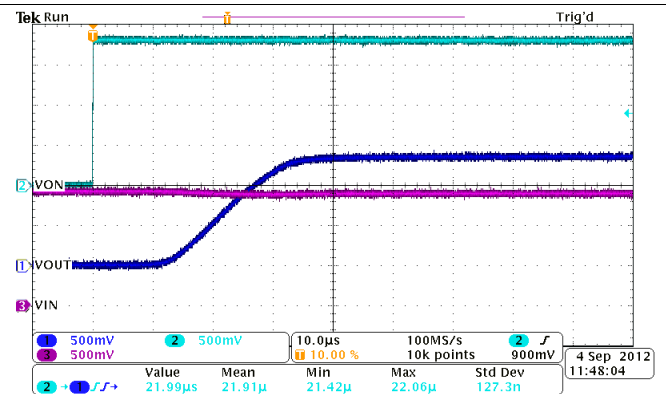

Figure 21. Turn-On Response Time  
 $(V_{IN} = 1.4\text{ V}, C_{IN} = 10\ \mu\text{F}, C_L = 0.1\ \mu\text{F}, R_L = 10\ \Omega)$

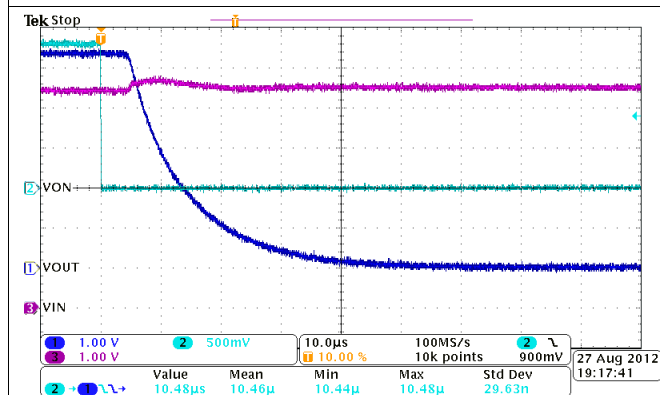

Figure 22. Turn-Off Response Time  
 $(V_{IN} = 5.5\text{ V}, C_{IN} = 10\ \mu\text{F}, C_L = 1\ \mu\text{F}, R_L = 10\ \Omega)$

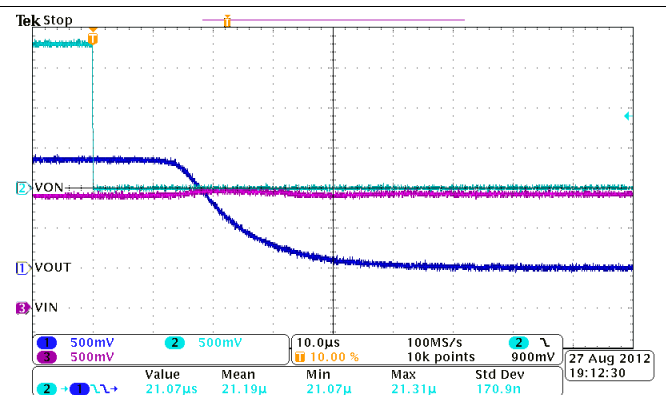
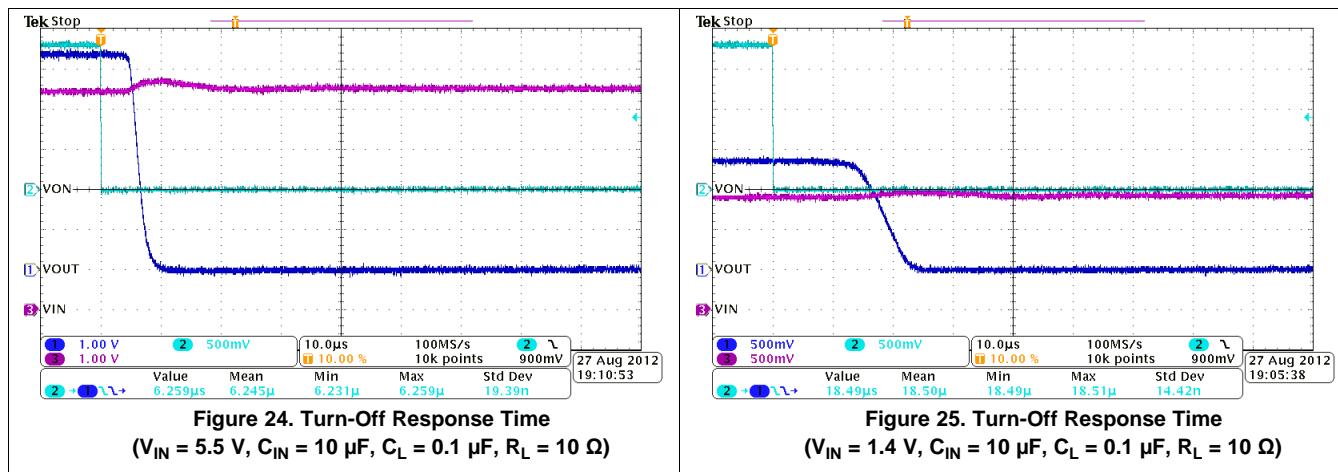
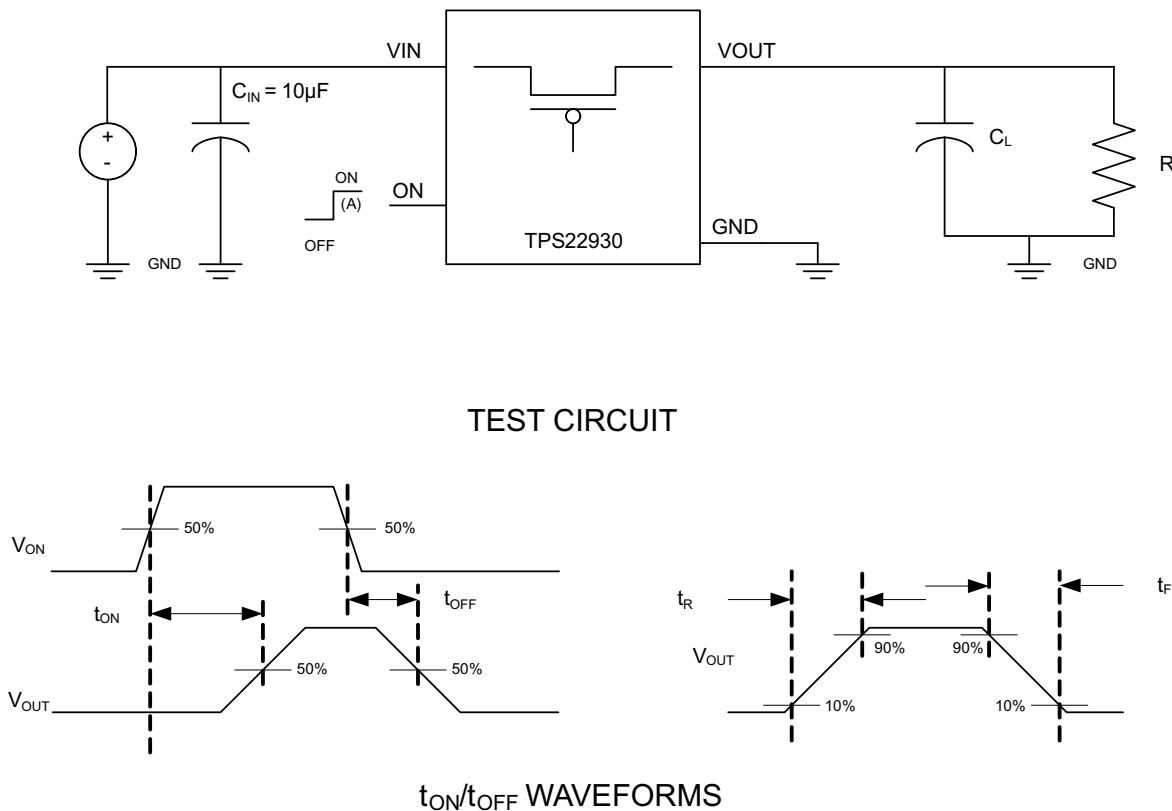

Figure 23. Turn-Off Response Time  
 $(V_{IN} = 1.4\text{ V}, C_{IN} = 10\ \mu\text{F}, C_L = 1\ \mu\text{F}, R_L = 10\ \Omega)$

Typical AC Scope Captures at  $T_A = 25^\circ\text{C}$  (continued)



8 Parameter Measurement Information



(A) Rise and fall times of the control signal are 100ns.

Figure 26. Test Circuit and  $t_{ON}/t_{OFF}$  Waveforms

## 9 Detailed Description

### 9.1 Overview

The TPS22930 is a single channel, 2-A load switch in a 4-terminal BSGA package. A low enable threshold makes it capable of interfacing directly with low voltage control signals. In the off state, the device has very low leakage current during off state. This prevents downstream circuits from pulling high standby current from the supply. When turning on, the output will rise with a controlled slew rate to limit inrush current.

The device will also disengage the body diode when disabled to provide reverse current protection. The undervoltage lockout (UVLO) threshold will ensure the switch is turned off and will block reverse current if the  $V_{IN}$  power supply is removed

### 9.2 Functional Block Diagram

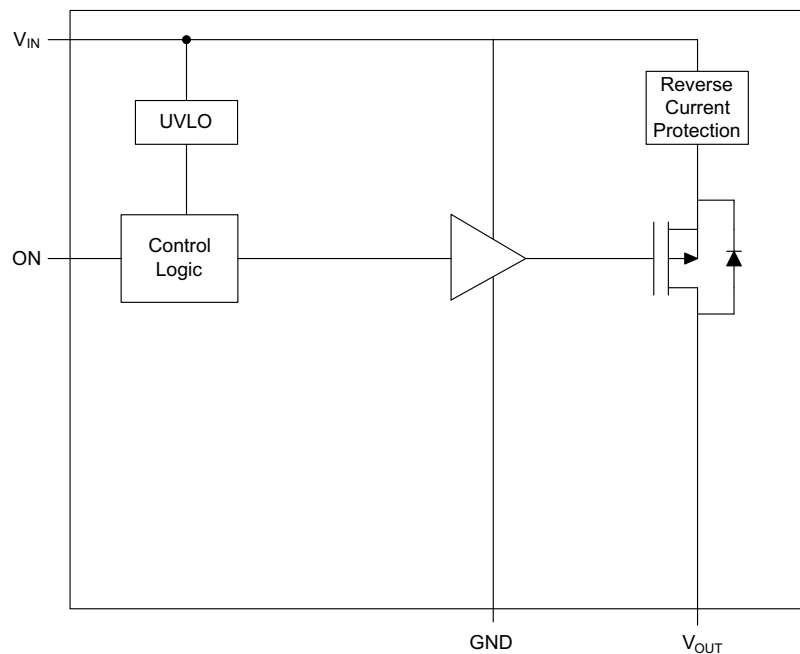

### 9.3 Feature Description

**Table 1. Feature List**

DEVICE	$R_{ON}$ (TYP) AT 4.2 V	RISE TIME AT 4.2 V (TYP)	QUICK OUTPUT DISCHARGE <sup>(1)</sup>	MAXIMUM CONTINUOUS CURRENT	ENABLE
TPS22930A	35 m $\Omega$	5.4 $\mu$ s	No	2 A	Active High

(1) This feature discharges output of the switch to GND through a resistor, preventing the output from floating when the pass FET is disabled

#### 9.3.1 On And Off Control

The ON pins control the state of the switch. Asserting ON high enables the switch. ON is active high and has a low threshold, making it capable of interfacing with low-voltage signals. The ON pin is compatible with standard GPIO logic threshold. It can be used with any microcontroller with 1.2V or higher GPIO voltage.

#### 9.3.2 UVLO

UVLO turns off the switch if the input voltage drops below the under voltage lockout threshold. With the ON pin active, the input voltage rising above the under voltage lockout threshold will allow a controlled turn-on of the switch to limit current over-shoot.

The maximum UVLO of the TPS22930A is 1.2 V. This is under the minimum  $V_{IN}$  voltage and meets the system UVLO requirements. Once the device is disabled through UVLO, it will block reverse current in the case a voltage is applied to  $V_{OUT}$

### 9.3.3 Reverse Current Protection

Reverse current protection (RCP) is only active when ON is asserted low. When ON is asserted high, current can flow from  $V_{OUT}$  to  $V_{IN}$  or from  $V_{IN}$  to  $V_{OUT}$ . This allows the device to function as a bi-directional switch when enabled.

## 9.4 Device Functional Modes

[Table 2](#) describes the state of the switch and the reverse current protection as determined by the ON pin.

**Table 2. Switch and Reverse Current Protection State**

ON	$V_{IN}$ to $V_{Out}$	RCP
H	On	Off
L	Off	On

## 10 Application and Implementation

### NOTE

Information in the following applications sections is not part of the TI component specification, and TI does not warrant its accuracy or completeness. TI's customers are responsible for determining suitability of components for their purposes. Customers should validate and test their design implementation to confirm system functionality.

### 10.1 Application Information

#### 10.1.1 Input Capacitor (Optional)

To limit the voltage drop on the input supply caused by transient in-rush currents when the switch turns on into a discharged load capacitor or short-circuit, it is recommended that a capacitor be placed between VIN and GND. A 1- $\mu$ F ceramic capacitor,  $C_{IN}$ , placed close to the pins, is usually sufficient. Higher values of  $C_{IN}$  can be used to further reduce the voltage drop during high-current application. When switching heavy loads, it is recommended to have an input capacitor about 100 times higher than the output capacitor to avoid excessive voltage drop; however, a 100 to 1 ratio is not required for proper functionality of the device.

#### 10.1.2 Output Capacitor (Optional)

Due to the integrated body diode in the PMOS switch, a  $C_{IN}$  greater than  $C_L$  is highly recommended. A  $C_L$  greater than  $C_{IN}$  can cause  $V_{OUT}$  to exceed  $V_{IN}$  when the system supply is removed. This could result in current flow through the body diode from  $V_{OUT}$  to  $V_{IN}$ . A  $C_{IN}$  to  $C_L$  ratio of 100 to 1 is recommended for minimizing  $V_{IN}$  dip caused by inrush currents during startup; however, a 100 to 1 ratio is not required for proper functionality of the device.

### 10.2 Typical Application

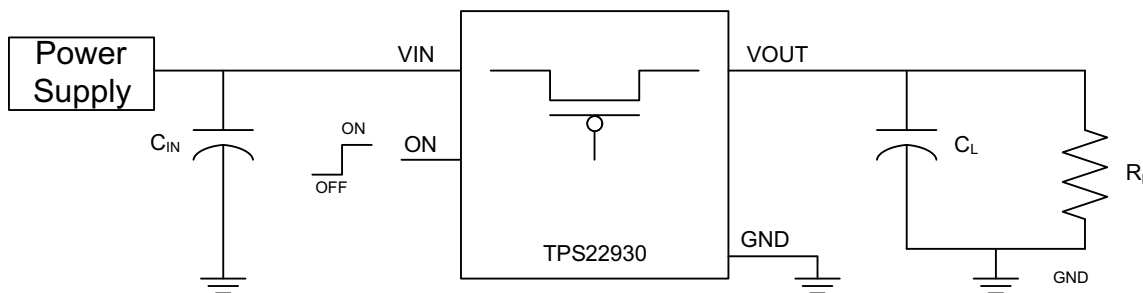

Figure 27. Typical Application Schematic

#### 10.2.1 Design Requirements

For this design example, the following will be used as the system requirements.

Table 3. Design Parameters

DESIGN PARAMETER	EXAMPLE VALUE
$V_{IN}$ Range	1.5 V to 5.5 V
UVLO Threshold	< 1.5 V
Reverse Current Protection	Required
Load Current	1 A
Ambient Temperature	25 °C

### 10.2.2 Detailed Design Procedure

To begin the design process, the designer needs to know the following:

- Input Voltage range
- UVLO Threshold
- Load Current
- Ambient Temperature

### 10.2.3 Application Curve

Figure 28 shows the UVLO response when the device is enabled.

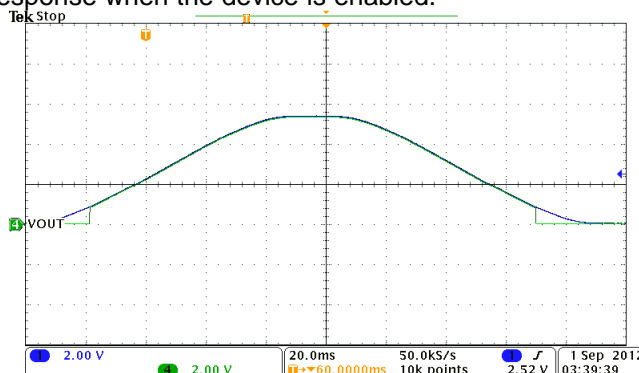

ON = 5 V

Figure 28. UVLO Response

## 11 Power Supply Recommendations

The device is designed to operate from a VIN range of 1.5 V to 5.5 V. The power supply should be well regulated and placed as close to the device terminals as possible. It must be able to withstand all transient and load current steps. In most situations, using an input capacitance of 1  $\mu$ F is sufficient to prevent the supply voltage from dipping when the switch is turned on. In cases where the power supply is slow to respond to a large transient current or large load current step, additional bulk capacitance may be required on the input

## 12 Layout

### 12.1 Layout Guidelines

For best performance, all traces should be as short as possible. To be most effective, the input and output capacitors should be placed close to the device to minimize the effects that parasitic trace inductances may have on normal operation. Using wide traces for VIN, VOUT, and GND helps minimize the parasitic electrical effects along with minimizing the case to ambient thermal impedance. The ON pin cannot be left floating and must be driven either high or low for proper functionality.

Figure 29 shows an example of a layout.

## 12.2 Layout Example

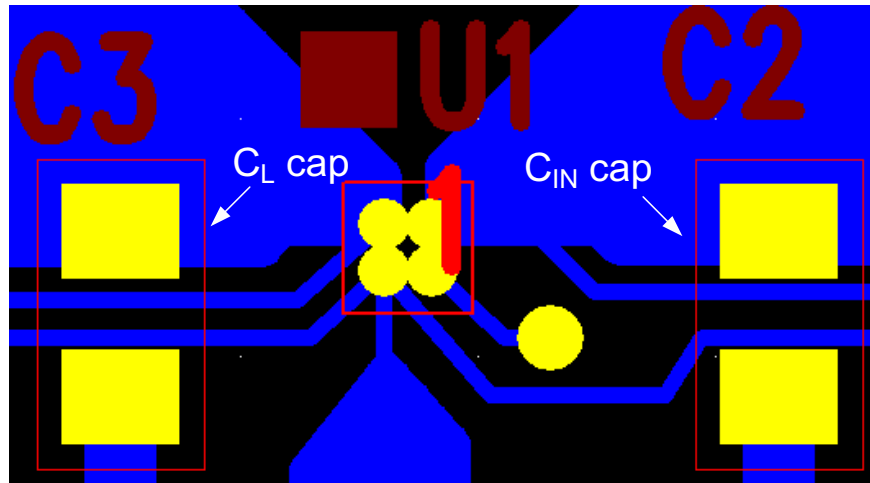

**Figure 29. Layout Recommendation**

## 12.3 Thermal Considerations

The maximum IC junction temperature should be restricted to 125°C under normal operating conditions. To calculate the maximum allowable dissipation,  $P_{D(max)}$  for a given output current and ambient temperature, use the following equation as a guideline:

$$P_{D(max)} = \frac{T_{J(max)} - T_A}{\theta_{JA}}$$

where

- $P_{D(max)}$  = maximum allowable power dissipation
- $T_{J(max)}$  = maximum allowable junction temperature (125°C for the TPS22930)
- $T_A$  = ambient temperature of the device
- $\theta_{JA}$  = junction to air thermal impedance. See [Thermal Information](#) table. This parameter is highly dependent upon board layout. (1)

The power dissipated by the device depends on the  $R_{ON}$  of the device at a given  $V_{IN}$ . To calculate the amount of power being dissipated by the device, use the following equation:

$$P_{IR} = I^2 \times R_{ON}$$

where

- $P_{IR}$  = power dissipated by the device
- $I$  = load current in amperes
- $R_{ON}$  = resistance of the device in Ohms at a given  $V_{IN}$  (see [Electrical Characteristics](#) table) (2)

The result from [Equation 2](#) should always be less than or equal to the result from [Equation 1](#).

## 13 Device and Documentation Support

### 13.1 Community Resources

The following links connect to TI community resources. Linked contents are provided "AS IS" by the respective contributors. They do not constitute TI specifications and do not necessarily reflect TI's views; see TI's [Terms of Use](#).

**TI E2E™ Online Community** *TI's Engineer-to-Engineer (E2E) Community*. Created to foster collaboration among engineers. At [e2e.ti.com](http://e2e.ti.com), you can ask questions, share knowledge, explore ideas and help solve problems with fellow engineers.

**Design Support** *TI's Design Support* Quickly find helpful E2E forums along with design support tools and contact information for technical support.

### 13.2 Trademarks

E2E is a trademark of Texas Instruments.  
All other trademarks are the property of their respective owners.

### 13.3 Electrostatic Discharge Caution



These devices have limited built-in ESD protection. The leads should be shorted together or the device placed in conductive foam during storage or handling to prevent electrostatic damage to the MOS gates.

### 13.4 Glossary

[SLYZ022](#) — *TI Glossary*.

This glossary lists and explains terms, acronyms, and definitions.

## 14 Mechanical, Packaging, and Orderable Information

The following pages include mechanical, packaging, and orderable information. This information is the most current data available for the designated devices. This data is subject to change without notice and revision of this document. For browser-based versions of this data sheet, refer to the left-hand navigation.

**PACKAGING INFORMATION**

Orderable Device	Status (1)	Package Type	Package Drawing	Pins	Package Qty	Eco Plan (2)	Lead/Ball Finish (6)	MSL Peak Temp (3)	Op Temp (°C)	Device Marking (4/5)	Samples
TPS22930AYZVR	ACTIVE	DSBGA	YZV	4	3000	Green (RoHS & no Sb/Br)	SNAGCU	Level-1-260C-UNLIM	-40 to 85	3Q	<a href="#">Samples</a>
TPS22930AYZVT	ACTIVE	DSBGA	YZV	4	250	Green (RoHS & no Sb/Br)	SNAGCU	Level-1-260C-UNLIM	-40 to 85	3Q	<a href="#">Samples</a>

(1) The marketing status values are defined as follows:

**ACTIVE:** Product device recommended for new designs.

**LIFEBUY:** TI has announced that the device will be discontinued, and a lifetime-buy period is in effect.

**NRND:** Not recommended for new designs. Device is in production to support existing customers, but TI does not recommend using this part in a new design.

**PREVIEW:** Device has been announced but is not in production. Samples may or may not be available.

**OBSOLETE:** TI has discontinued the production of the device.

(2) Eco Plan - The planned eco-friendly classification: Pb-Free (RoHS), Pb-Free (RoHS Exempt), or Green (RoHS & no Sb/Br) - please check <http://www.ti.com/productcontent> for the latest availability information and additional product content details.

**TBD:** The Pb-Free/Green conversion plan has not been defined.

**Pb-Free (RoHS):** TI's terms "Lead-Free" or "Pb-Free" mean semiconductor products that are compatible with the current RoHS requirements for all 6 substances, including the requirement that lead not exceed 0.1% by weight in homogeneous materials. Where designed to be soldered at high temperatures, TI Pb-Free products are suitable for use in specified lead-free processes.

**Pb-Free (RoHS Exempt):** This component has a RoHS exemption for either 1) lead-based flip-chip solder bumps used between the die and package, or 2) lead-based die adhesive used between the die and leadframe. The component is otherwise considered Pb-Free (RoHS compatible) as defined above.

**Green (RoHS & no Sb/Br):** TI defines "Green" to mean Pb-Free (RoHS compatible), and free of Bromine (Br) and Antimony (Sb) based flame retardants (Br or Sb do not exceed 0.1% by weight in homogeneous material)

(3) MSL, Peak Temp. - The Moisture Sensitivity Level rating according to the JEDEC industry standard classifications, and peak solder temperature.

(4) There may be additional marking, which relates to the logo, the lot trace code information, or the environmental category on the device.

(5) Multiple Device Markings will be inside parentheses. Only one Device Marking contained in parentheses and separated by a "~" will appear on a device. If a line is indented then it is a continuation of the previous line and the two combined represent the entire Device Marking for that device.

(6) Lead/Ball Finish - Orderable Devices may have multiple material finish options. Finish options are separated by a vertical ruled line. Lead/Ball Finish values may wrap to two lines if the finish value exceeds the maximum column width.

**Important Information and Disclaimer:** The information provided on this page represents TI's knowledge and belief as of the date that it is provided. TI bases its knowledge and belief on information provided by third parties, and makes no representation or warranty as to the accuracy of such information. Efforts are underway to better integrate information from third parties. TI has taken and continues to take reasonable steps to provide representative and accurate information but may not have conducted destructive testing or chemical analysis on incoming materials and chemicals. TI and TI suppliers consider certain information to be proprietary, and thus CAS numbers and other limited information may not be available for release.

In no event shall TI's liability arising out of such information exceed the total purchase price of the TI part(s) at issue in this document sold by TI to Customer on an annual basis.

## TAPE AND REEL INFORMATION



### QUADRANT ASSIGNMENTS FOR PIN 1 ORIENTATION IN TAPE



\*All dimensions are nominal

Device	Package Type	Package Drawing	Pins	SPQ	Reel Diameter (mm)	Reel Width W1 (mm)	A0 (mm)	B0 (mm)	K0 (mm)	P1 (mm)	W (mm)	Pin1 Quadrant
TPS22930AYZVR	DSBGA	YZV	4	3000	180.0	8.4	1.0	1.0	0.63	4.0	8.0	Q1
TPS22930AYZVT	DSBGA	YZV	4	250	180.0	8.4	1.0	1.0	0.63	4.0	8.0	Q1

**TAPE AND REEL BOX DIMENSIONS**

\*All dimensions are nominal

Device	Package Type	Package Drawing	Pins	SPQ	Length (mm)	Width (mm)	Height (mm)
TPS22930AYZVR	DSBGA	YZV	4	3000	182.0	182.0	20.0
TPS22930AYZVT	DSBGA	YZV	4	250	182.0	182.0	20.0

YZV (S-XBGA-N4)

DIE-SIZE BALL GRID ARRAY

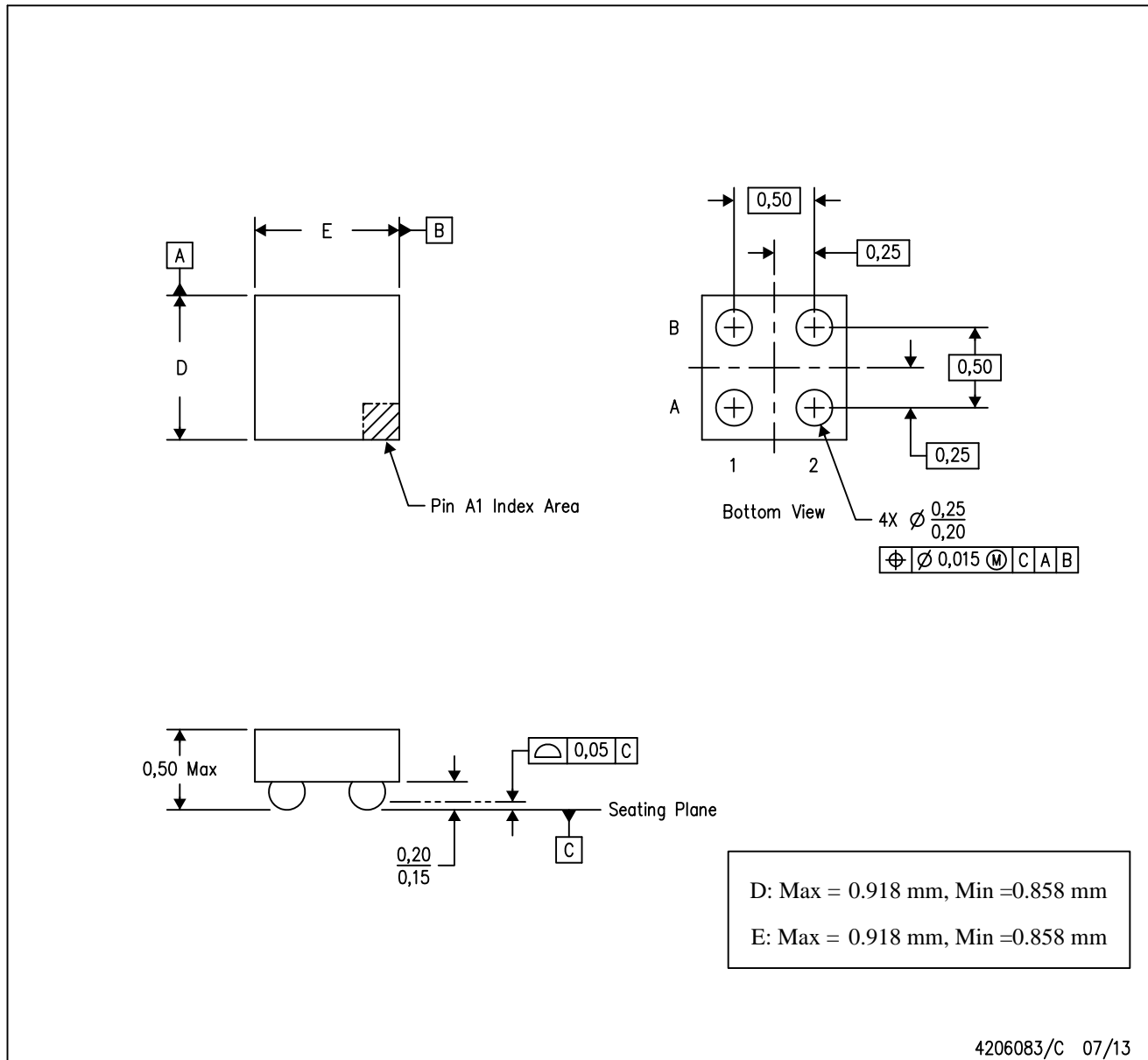

- NOTES:
- A. All linear dimensions are in millimeters. Dimensioning and tolerancing per ASME Y14.5M-1994.
  - B. This drawing is subject to change without notice.
  - C. NanoFree™ package configuration.

NanoFree is a trademark of Texas Instruments.

## IMPORTANT NOTICE AND DISCLAIMER

TI PROVIDES TECHNICAL AND RELIABILITY DATA (INCLUDING DATASHEETS), DESIGN RESOURCES (INCLUDING REFERENCE DESIGNS), APPLICATION OR OTHER DESIGN ADVICE, WEB TOOLS, SAFETY INFORMATION, AND OTHER RESOURCES "AS IS" AND WITH ALL FAULTS, AND DISCLAIMS ALL WARRANTIES, EXPRESS AND IMPLIED, INCLUDING WITHOUT LIMITATION ANY IMPLIED WARRANTIES OF MERCHANTABILITY, FITNESS FOR A PARTICULAR PURPOSE OR NON-INFRINGEMENT OF THIRD PARTY INTELLECTUAL PROPERTY RIGHTS.

These resources are intended for skilled developers designing with TI products. You are solely responsible for (1) selecting the appropriate TI products for your application, (2) designing, validating and testing your application, and (3) ensuring your application meets applicable standards, and any other safety, security, or other requirements. These resources are subject to change without notice. TI grants you permission to use these resources only for development of an application that uses the TI products described in the resource. Other reproduction and display of these resources is prohibited. No license is granted to any other TI intellectual property right or to any third party intellectual property right. TI disclaims responsibility for, and you will fully indemnify TI and its representatives against, any claims, damages, costs, losses, and liabilities arising out of your use of these resources.

TI's products are provided subject to TI's Terms of Sale ([www.ti.com/legal/termsofsale.html](http://www.ti.com/legal/termsofsale.html)) or other applicable terms available either on [ti.com](http://ti.com) or provided in conjunction with such TI products. TI's provision of these resources does not expand or otherwise alter TI's applicable warranties or warranty disclaimers for TI products.

Mailing Address: Texas Instruments, Post Office Box 655303, Dallas, Texas 75265  
Copyright © 2019, Texas Instruments Incorporated

## Looking for pricing, stock, or lifecycle information?

Click below to explore more details on WIN SOURCE:

 [View TPS22930AYZVR on WIN SOURCE](#)

 [Texas Instruments](#) Information

## Optimize Your Supply Chain with WIN SOURCE Solutions

-  Global Sourcing Solution
-  Obsolete Management
-  Cost Control Management
-  Shortage Management
-  Alternative Solution
-  Excess Inventory Management