



**THE DATASHEET OF  
FDH15N50**



## FDH15N50 / FDP15N50 / FDB15N50

### 15A, 500V, 0.38 Ohm, N-Channel SMPS Power MOSFET

#### Applications

**Switch Mode Power Supplies(SMPS), such as**

- PFC Boost
- Two-Switch Forward Converter
- Single Switch Forward Converter
- Flyback Converter
- Buck Converter
- High Speed Switching

#### Features

- Low Gate Charge  $Q_g$  results in Simple Drive Requirement
- Improved Gate, Avalanche and High Reapplied  $dv/dt$  Ruggedness
- Reduced  $t_{DS(ON)}$
- Reduced Miller Capacitance and Low Input Capacitance
- Improved Switching Speed with Low EMI
- 175°C Rated Junction Temperature

#### Package

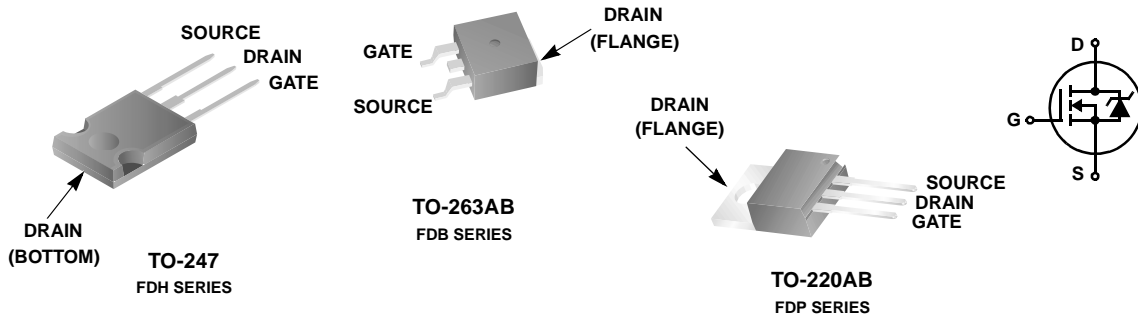

#### Absolute Maximum Ratings $T_C = 25^\circ\text{C}$ unless otherwise noted

Symbol	Parameter	Ratings	Units
$V_{DSS}$	Drain to Source Voltage	500	V
$V_{GS}$	Gate to Source Voltage	$\pm 30$	V
$I_D$	Drain Current		
	Continuous ( $T_C = 25^\circ\text{C}$ , $V_{GS} = 10\text{V}$ )	15	A
	Continuous ( $T_C = 100^\circ\text{C}$ , $V_{GS} = 10\text{V}$ )	11	A
	Pulsed <sup>1</sup>	60	A
$P_D$	Power dissipation	300	W
	Derate above $25^\circ\text{C}$	2	W/ $^\circ\text{C}$
$T_J, T_{STG}$	Operating and Storage Temperature	-55 to 175	$^\circ\text{C}$
	Soldering Temperature for 10 seconds	300 (1.6mm from case)	$^\circ\text{C}$

#### Thermal Characteristics

Symbol	Parameter	Value	Units
$R_{\theta JC}$	Thermal Resistance Junction to Case	0.50	$^\circ\text{C}/\text{W}$
$R_{\theta JA}$	Thermal Resistance Junction to Ambient (TO-247)	40	$^\circ\text{C}/\text{W}$
$R_{\theta JA}$	Thermal Resistance Junction to Ambient (TO-220, TO-263)	62	$^\circ\text{C}/\text{W}$

## Package Marking and Ordering Information

Device Marking	Device	Package	Reel Size	Tape Width	Quantity
FDH15N50	FDH15N50	TO-247	Tube	-	30
FDP15N50	FDP15N50	TO-220	Tube	-	50
FDB15N50	FDB15N50	TO-263	330mm	24mm	800

## Electrical Characteristics $T_J = 25^\circ\text{C}$ (unless otherwise noted)

Symbol	Parameter	Test Conditions	Min	Typ	Max	Units
--------	-----------	-----------------	-----	-----	-----	-------

### Statics

$B_{VDSS}$	Drain to Source Breakdown Voltage	$I_D = 250\mu\text{A}$ , $V_{GS} = 0\text{V}$	500	-	-	V
$\Delta B_{VDSS}/\Delta T_J$	Breakdown Voltage Temp. Coefficient	Reference to $25^\circ\text{C}$ , $I_D = 1\text{mA}$	-	0.58	-	$\text{V}/^\circ\text{C}$
$r_{DS(ON)}$	Drain to Source On-Resistance	$V_{GS} = 10\text{V}$ , $I_D = 7.5\text{A}$	-	0.33	0.38	$\Omega$
$V_{GS(th)}$	Gate Threshold Voltage	$V_{DS} = V_{GS}$ , $I_D = 250\mu\text{A}$	2.0	3.4	4.0	V
$I_{DSS}$	Zero Gate Voltage Drain Current	$V_{DS} = 500\text{V}$	-	-	25	$\mu\text{A}$
		$V_{GS} = 0\text{V}$	-	-	250	
$I_{GSS}$	Gate to Source Leakage Current	$V_{GS} = \pm 30\text{V}$	-	-	$\pm 100$	nA

### Dynamics

$g_{fs}$	Forward Transconductance	$V_{DD} = 10\text{V}$ , $I_D = 7.5\text{A}$	10	-	-	S
$Q_{g(TOT)}$	Total Gate Charge at 10V	$V_{GS} = 10\text{V}$ , $V_{DS} = 400\text{V}$ , $I_D = 15\text{A}$	-	33	41	nC
$Q_{gs}$	Gate to Source Gate Charge		-	7.2	10	nC
$Q_{gd}$	Gate to Drain "Miller" Charge		-	12	16	nC
$t_{d(ON)}$	Turn-On Delay Time		$V_{DD} = 250\text{V}$ , $I_D = 15\text{A}$ , $R_G = 6.2\Omega$ , $R_D = 17\Omega$	-	9	-
$t_r$	Rise Time		-	5.4	-	ns
$t_{d(OFF)}$	Turn-Off Delay Time		-	26	-	ns
$t_f$	Fall Time		-	5	-	ns
$C_{ISS}$	Input Capacitance	$V_{DS} = 25\text{V}$ , $V_{GS} = 0\text{V}$ , $f = 1\text{MHz}$	-	1850	-	pF
$C_{OSS}$	Output Capacitance		-	230	-	pF
$C_{RSS}$	Reverse Transfer Capacitance		-	16	-	pF

### Avalanche Characteristics

$E_{AS}$	Single Pulse Avalanche Energy <sup>2</sup>		760	-	-	mJ
$I_{AR}$	Avalanche Current		-	-	15	A

### Drain-Source Diode Characteristics

$I_S$	Continuous Source Current (Body Diode)	MOSFET symbol showing the integral reverse p-n junction diode. 	-	-	15	A
$I_{SM}$	Pulsed Source Current <sup>1</sup> (Body Diode)		-	-	60	A
$V_{SD}$	Source to Drain Diode Voltage	$I_{SD} = 15\text{A}$	-	0.86	1.2	V
$t_{rr}$	Reverse Recovery Time	$I_{SD} = 15\text{A}$ , $di_{SD}/dt = 100\text{A}/\mu\text{s}$	-	470	730	ns
$Q_{RR}$	Reverse Recovered Charge	$I_{SD} = 15\text{A}$ , $di_{SD}/dt = 100\text{A}/\mu\text{s}$	-	5	6.6	$\mu\text{C}$

#### Notes:

- 1: Repetitive rating; pulse width limited by maximum junction temperature
- 2: Starting  $T_J = 25^\circ\text{C}$ ,  $L = 7.0\text{mH}$ ,  $I_{AS} = 15\text{A}$

## Typical Characteristics

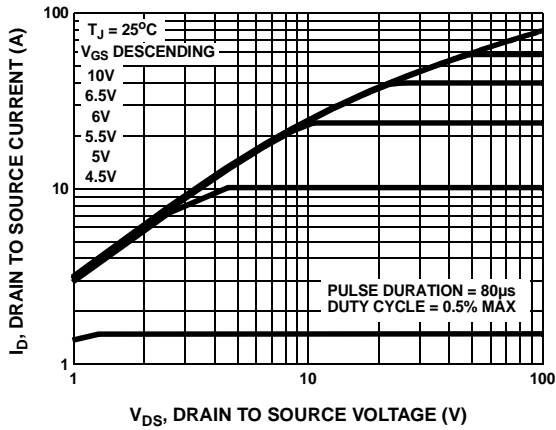

Figure 1. Output Characteristics

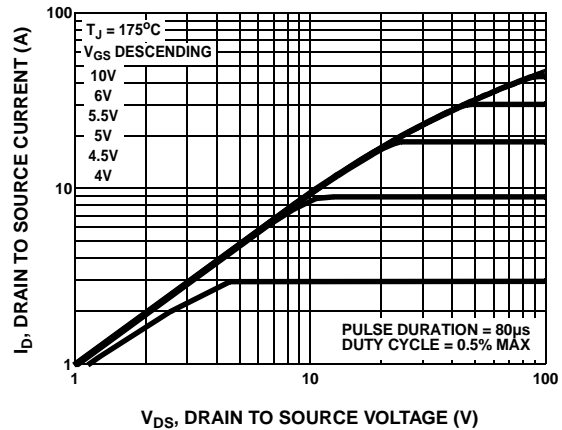

Figure 2. Output Characteristics

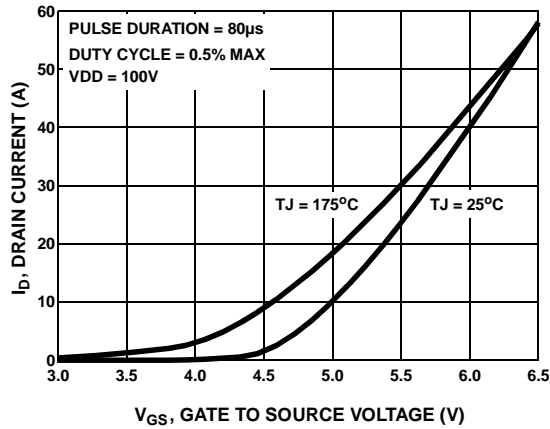

Figure 3. Transfer Characteristics

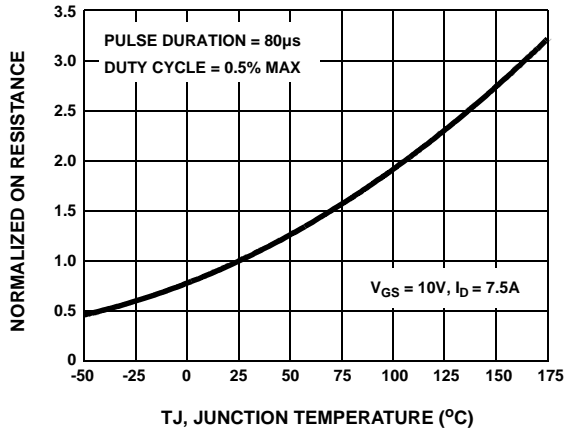

Figure 4. Normalized Drain To Source On Resistance vs Junction Temperature

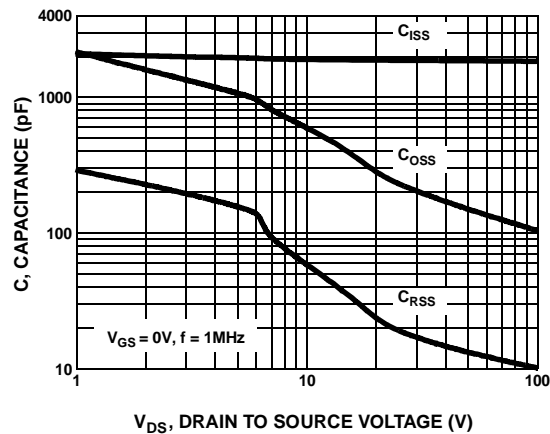

Figure 5. Capacitance vs Drain To Source Voltage

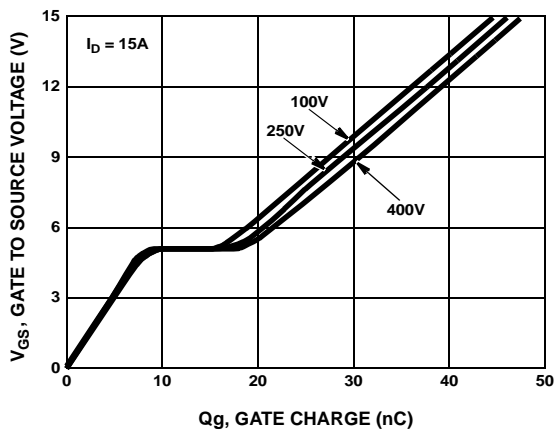

Figure 6. Gate Charge Waveforms For Constant Gate Current

## Typical Characteristics

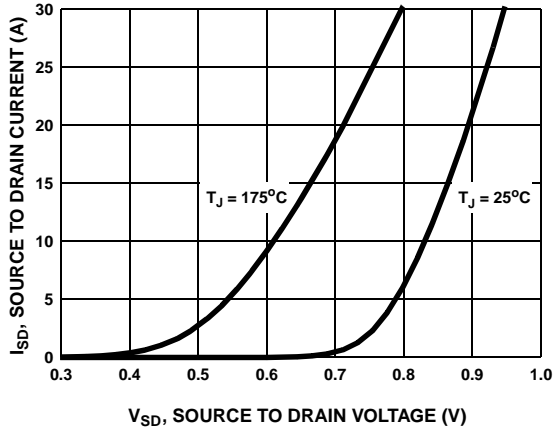

Figure 7. Body Diode Forward Voltage vs Body Diode Current

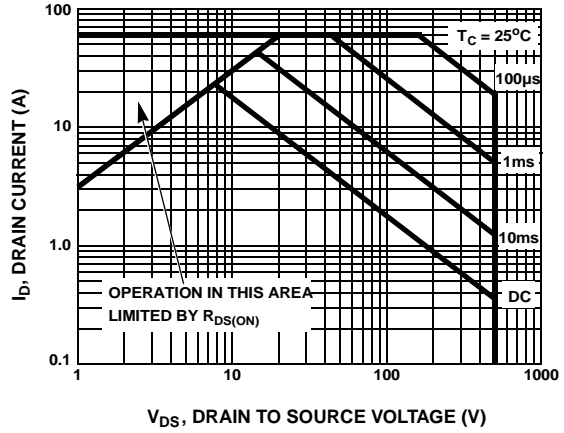

Figure 8. Maximum Safe Operating Area

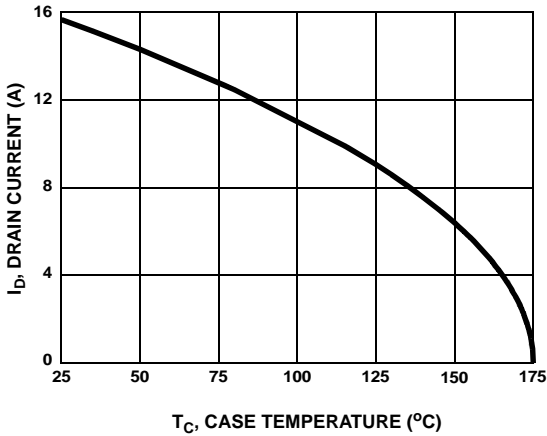

Figure 9. Maximum Drain Current vs Case Temperature

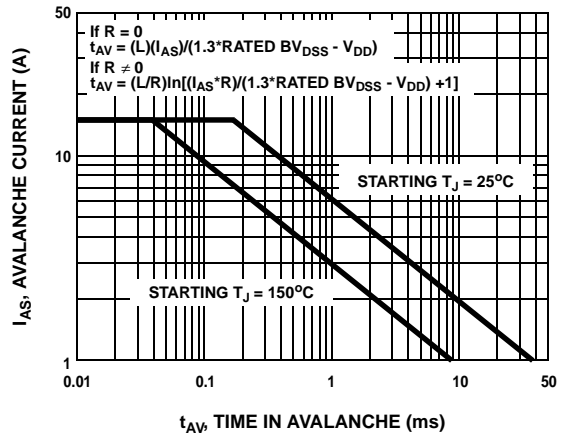

Figure 10. Unclamped Inductive Switching Capability

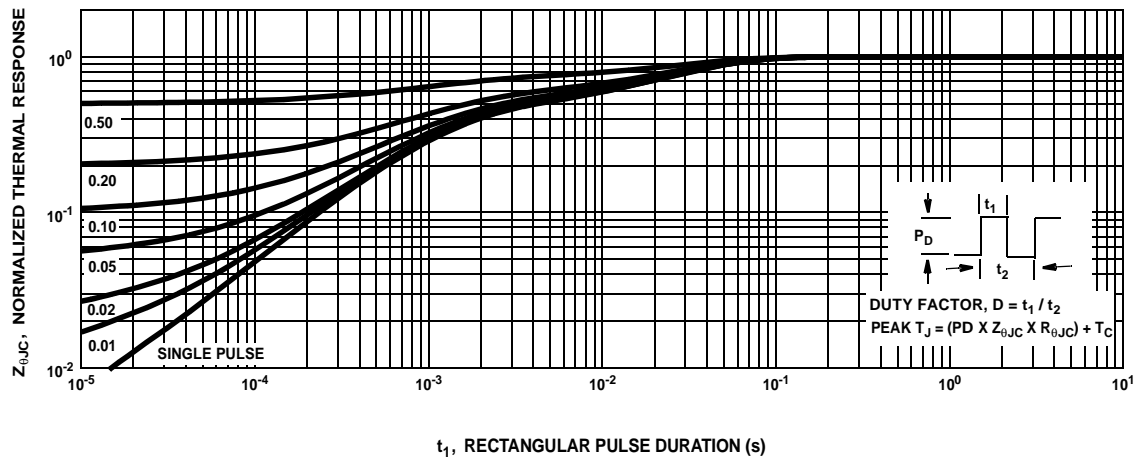
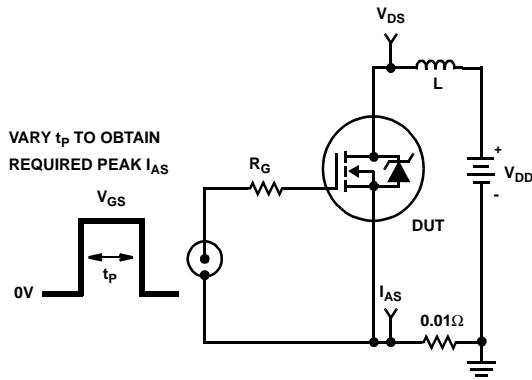
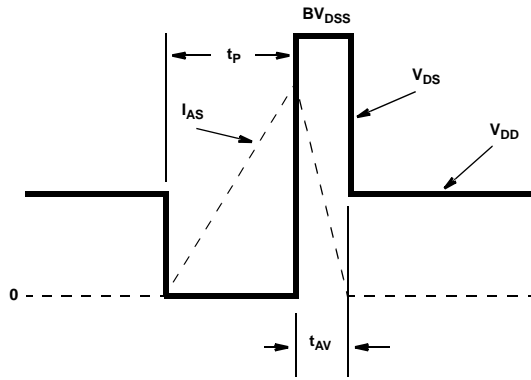

Figure 11. Normalized Transient Thermal Impedance, Junction to Case

**Test Circuits and Waveforms**



**Figure 12. Unclamped Energy Test Circuit**



**Figure 13. Unclamped Energy Waveforms**

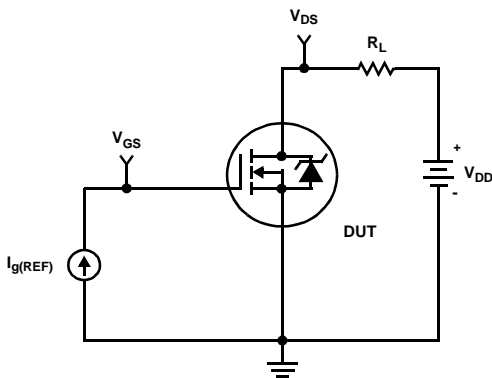

**Figure 14. Gate Charge Test Circuit**

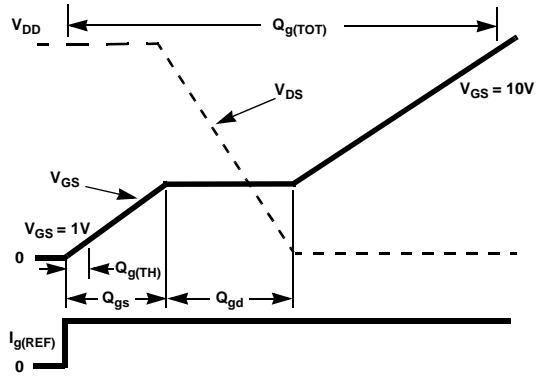

**Figure 15. Gate Charge Waveforms**

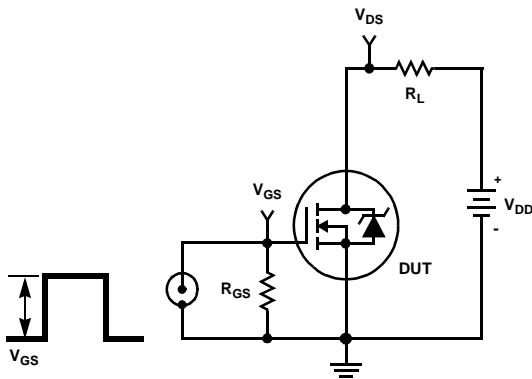

**Figure 16. Switching Time Test Circuit**

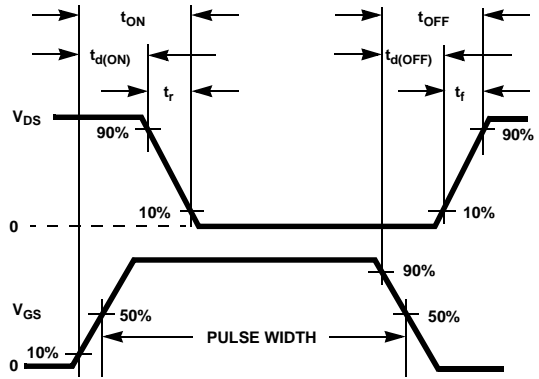

**Figure 17. Switching Time Waveform**

## TRADEMARKS

The following are registered and unregistered trademarks Fairchild Semiconductor owns or is authorized to use and is not intended to be an exhaustive list of all such trademarks.

ACEx™	FACT™	ImpliedDisconnect™	PACMAN™	SPM™
ActiveArray™	FACT Quiet Series™	ISOPLANAR™	POP™	Stealth™
Bottomless™	FAST®	LittleFET™	Power247™	SuperSOT™-3
CoolFET™	FASTr™	MicroFET™	PowerTrench®	SuperSOT™-6
CROSSVOLT™	FRFET™	MicroPak™	QFET®	SuperSOT™-8
DOME™	GlobalOptoisolator™	MICROWIRE™	QS™	SyncFET™
EcoSPARK™	GTO™	MSX™	QT Optoelectronics™	TinyLogic®
E <sup>2</sup> C MOS™	HiSeC™	MSXPro™	Quiet Series™	TruTranslation™
EnSigna™	I <sup>2</sup> C™	OCX™	RapidConfigure™	UHC™
Across the board. Around the world.™		OCXPro™	RapidConnect™	UltraFET®
The Power Franchise™		OPTOLOGIC®	SILENT SWITCHER®	VCX™
Programmable Active Droop™		OPTOPLANAR™	SMART START™	

## DISCLAIMER

FAIRCHILD SEMICONDUCTOR RESERVES THE RIGHT TO MAKE CHANGES WITHOUT FURTHER NOTICE TO ANY PRODUCTS HEREIN TO IMPROVE RELIABILITY, FUNCTION OR DESIGN. FAIRCHILD DOES NOT ASSUME ANY LIABILITY ARISING OUT OF THE APPLICATION OR USE OF ANY PRODUCT OR CIRCUIT DESCRIBED HEREIN; NEITHER DOES IT CONVEY ANY LICENSE UNDER ITS PATENT RIGHTS, NOR THE RIGHTS OF OTHERS.

## LIFE SUPPORT POLICY

FAIRCHILD'S PRODUCTS ARE NOT AUTHORIZED FOR USE AS CRITICAL COMPONENTS IN LIFE SUPPORT DEVICES OR SYSTEMS WITHOUT THE EXPRESS WRITTEN APPROVAL OF FAIRCHILD SEMICONDUCTOR CORPORATION.

As used herein:

1. Life support devices or systems are devices or systems which, (a) are intended for surgical implant into the body, or (b) support or sustain life, or (c) whose failure to perform when properly used in accordance with instructions for use provided in the labeling, can be reasonably expected to result in significant injury to the user.
2. A critical component is any component of a life support device or system whose failure to perform can be reasonably expected to cause the failure of the life support device or system, or to affect its safety or effectiveness.



## PRODUCT STATUS DEFINITIONS

### Definition of Terms

Datasheet Identification	Product Status	Definition
Advance Information	Formative or In Design	This datasheet contains the design specifications for product development. Specifications may change in any manner without notice.
Preliminary	First Production	This datasheet contains preliminary data, and supplementary data will be published at a later date. Fairchild Semiconductor reserves the right to make changes at any time without notice in order to improve design.
No Identification Needed	Full Production	This datasheet contains final specifications. Fairchild Semiconductor reserves the right to make changes at any time without notice in order to improve design.
Obsolete	Not In Production	This datasheet contains specifications on a product that has been discontinued by Fairchild semiconductor. The datasheet is printed for reference information only.

## Looking for pricing, stock, or lifecycle information?

Click below to explore more details on WIN SOURCE:

-  [View FDH15N50 on WIN SOURCE](#)
-  [Fairchild/ON Semiconductor](#) Information

## Optimize Your Supply Chain with WIN SOURCE Solutions

-  Global Sourcing Solution
-  Obsolete Management
-  Cost Control Management
-  Shortage Management
-  Alternative Solution
-  Excess Inventory Management