



**THE DATASHEET OF  
IXFH66N20Q**



# HiPerFET™ Power MOSFETs Q-Class

IXFH 66N20Q  
IXFT 66N20Q

$V_{DSS} = 200 \text{ V}$   
 $I_{D25} = 66 \text{ A}$   
 $R_{DS(on)} = 40 \text{ m}\Omega$

$t_{rr} \leq 200 \text{ ns}$

N-Channel Enhancement Mode  
Avalanche Rated High dv/dt, Low  $Q_g$

Preliminary data sheet

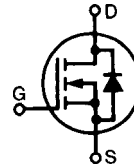

Symbol	Test Conditions	Maximum Ratings	
$V_{DSS}$	$T_J = 25^\circ\text{C}$ to $150^\circ\text{C}$	200	V
$V_{DGR}$	$T_J = 25^\circ\text{C}$ to $150^\circ\text{C}$ ; $R_{GS} = 1 \text{ M}\Omega$	200	V
$V_{GS}$	Continuous	$\pm 30$	V
$V_{GSM}$	Transient	$\pm 40$	V
$I_{D25}$	$T_C = 25^\circ\text{C}$	66	A
$I_{DM}$	$T_C = 25^\circ\text{C}$ , pulse width limited by $T_{JM}$	264	A
$I_{AR}$	$T_C = 25^\circ\text{C}$	66	A
$E_{AR}$	$T_C = 25^\circ\text{C}$	40	mJ
$E_{AS}$	$T_C = 25^\circ\text{C}$	1.5	J
dv/dt	$I_S \leq I_{DM}$ , $di/dt \leq 100 \text{ A}/\mu\text{s}$ , $V_{DD} \leq V_{DSS}$ , $T_J \leq 150^\circ\text{C}$ , $R_G = 2 \Omega$	20	V/ns
$P_D$	$T_C = 25^\circ\text{C}$	400	W
$T_J$		-55 ... +150	$^\circ\text{C}$
$T_{JM}$		150	$^\circ\text{C}$
$T_{stg}$		-55 ... +150	$^\circ\text{C}$
$T_L$	1.6 mm (0.062 in.) from case for 10 s	300	$^\circ\text{C}$
$M_d$	Mounting torque	1.13/10 Nm/lb.in.	
Weight	TO-247	6	g
	TO-268	4	g

## TO-268 (D3) (IXFT) Case Style

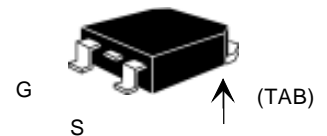

## TO-247 AD

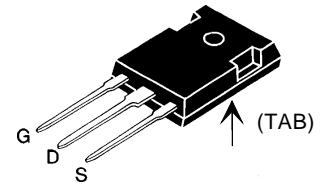

G = Gate      D = Drain  
S = Source      TAB = Drain

## Features

- IXYS advanced low  $Q_g$  process
- International standard packages
- Low gate charge and capacitance
  - easier to drive
  - faster switching
- Low  $R_{DS(on)}$
- Unclamped Inductive Switching (UIS) rated
- Molding epoxies meet UL 94 V-0 flammability classification

## Advantages

- Easy to mount
- Space savings
- High power density

Symbol	Test Conditions ( $T_J = 25^\circ\text{C}$ , unless otherwise specified)	Characteristic Values		
		Min.	Typ.	Max.
$V_{DSS}$	$V_{GS} = 0 \text{ V}$ , $I_D = 250 \mu\text{A}$	200		V
$V_{GS(th)}$	$V_{DS} = V_{GS}$ , $I_D = 4 \text{ mA}$	2.0		V
$I_{GSS}$	$V_{GS} = \pm 30 \text{ V}_{DC}$ , $V_{DS} = 0$			$\pm 100 \text{ nA}$
$I_{DSS}$	$V_{DS} = V_{DSS}$ , $T_J = 25^\circ\text{C}$			25 $\mu\text{A}$
	$V_{GS} = 0 \text{ V}$ , $T_J = 125^\circ\text{C}$			1 mA
$R_{DS(on)}$	$V_{GS} = 10 \text{ V}$ , $I_D = 0.5 I_{D25}$ Pulse test, $t \leq 300 \mu\text{s}$ , duty cycle $d \leq 2\%$			40 m $\Omega$

Symbol	Test Conditions	Characteristic Values ( $T_J = 25^\circ\text{C}$ , unless otherwise specified)		
		Min.	Typ.	Max.
$g_{fs}$	$V_{DS} = 10\text{ V}$ ; $I_D = 0.5 I_{D25}$ , pulse test	30	45	S
$C_{iss}$	$V_{GS} = 0\text{ V}$ , $V_{DS} = 25\text{ V}$ , $f = 1\text{ MHz}$		3700	pF
$C_{oss}$			860	pF
$C_{rss}$			260	pF
$t_{d(on)}$	$V_{GS} = 10\text{ V}$ , $V_{DS} = 0.5 V_{DSS}$ , $I_D = 0.5 I_{D25}$ $R_G = 2.0\ \Omega$ (External)		20	ns
$t_r$			18	ns
$t_{d(off)}$			50	ns
$t_f$			14	ns
$Q_{g(on)}$	$V_{GS} = 10\text{ V}$ , $V_{DS} = 0.5 V_{DSS}$ , $I_D = 0.5 I_{D25}$		105	nC
$Q_{gs}$			20	nC
$Q_{gd}$			44	nC
$R_{thJC}$			0.31	K/W
$R_{thCK}$	(TO-247)		0.25	K/W

Symbol	Test Conditions	Characteristic Values ( $T_J = 25^\circ\text{C}$ , unless otherwise specified)		
		min.	typ.	max.
$I_S$	$V_{GS} = 0\text{ V}$			66 A
$I_{SM}$	Repetitive;			264 A
$V_{SD}$	$I_F = I_S$ , $V_{GS} = 0\text{ V}$ , Pulse test, $t \leq 300\ \mu\text{s}$ , duty cycle $d \leq 2\%$			1.5 V
$t_{rr}$	$I_F = 25\text{ A}$ , $-di/dt = 100\text{ A}/\mu\text{s}$ , $V_R = 100\text{ V}$		0.6	200 ns
$Q_{RM}$			7	$\mu\text{C}$
$I_{RM}$				A

### Min. Recommended Footprint

Dimensions in mm and inches

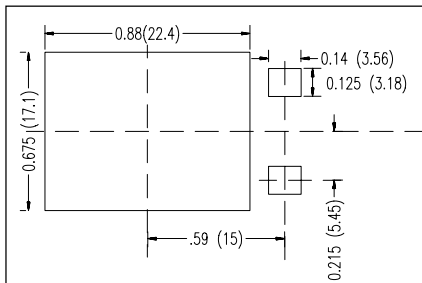

### TO-247 AD Outline

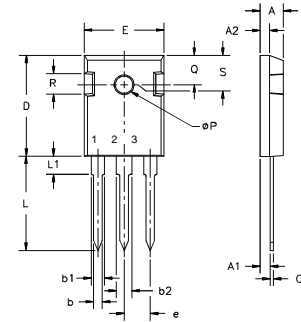

Terminals: 1 - Gate 2 - Drain  
3 - Source Tab - Drain

Dim.	Millimeter		Inches	
	Min.	Max.	Min.	Max.
A	4.7	5.3	.185	.209
A <sub>1</sub>	2.2	2.54	.087	.102
A <sub>2</sub>	2.2	2.6	.059	.098
b	1.0	1.4	.040	.055
b <sub>1</sub>	1.65	2.13	.065	.084
b <sub>2</sub>	2.87	3.12	.113	.123
C	.4	.8	.016	.031
D	20.80	21.46	.819	.845
E	15.75	16.26	.610	.640
e	5.20	5.72	0.205	0.225
L	19.81	20.32	.780	.800
L <sub>1</sub>		4.50		.177
∅P	3.55	3.65	.140	.144
Q	5.89	6.40	0.232	0.252
R	4.32	5.49	.170	.216
S	6.15	BSC	242	BSC

### TO-268 Outline

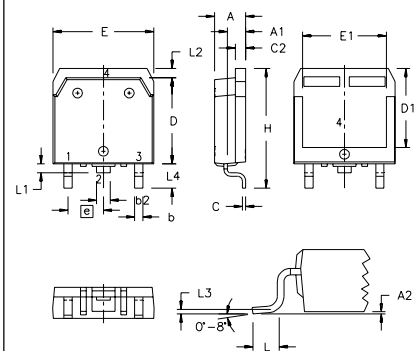

SYM	INCHES		MILLIMETERS	
	MIN	MAX	MIN	MAX
A	.193	.201	4.90	5.10
A <sub>1</sub>	.106	.114	2.70	2.90
A <sub>2</sub>	.001	.010	0.02	0.25
b	.045	.057	1.15	1.45
b <sub>2</sub>	.075	.083	1.90	2.10
C	.016	.026	0.40	0.65
C <sub>2</sub>	.057	.063	1.45	1.60
D	.543	.551	13.80	14.00
D <sub>1</sub>	.488	.500	12.40	12.70
E	.624	.632	15.85	16.05
E <sub>1</sub>	.524	.535	13.30	13.60
e	.215 BSC		5.45 BSC	
H	.736	.752	18.70	19.10
L	.094	.106	2.40	2.70
L <sub>1</sub>	.047	.055	1.20	1.40
L <sub>2</sub>	.039	.045	1.00	1.15
L <sub>3</sub>	.010 BSC		0.25 BSC	
L <sub>4</sub>	.150	.161	3.80	4.10

IXYS reserves the right to change limits, test conditions, and dimensions.

IXYS MOSFETs and IGBTs are covered by one or more of the following U.S. patents:

4,835,592 4,881,106 5,017,508 5,049,961 5,187,117 5,486,715 6,306,728B1 6,259,123B1 6,306,728B1  
4,850,072 4,931,844 5,034,796 5,063,307 5,237,481 5,381,025 6,404,065B1 6,162,665 6,534,343

**Fig. 1. Output Characteristics**  
**@ 25 Deg. C**

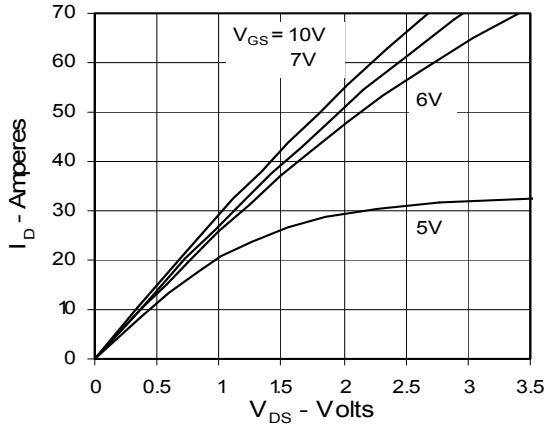

**Fig. 2. Extended Output Characteristics**  
**@ 25 deg. C**

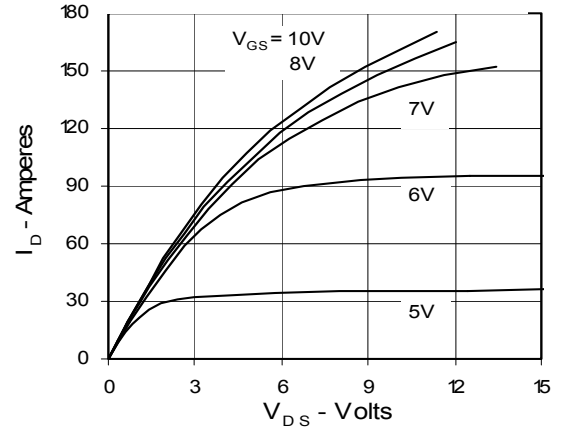

**Fig. 3. Output Characteristics**  
**@ 125 Deg. C**

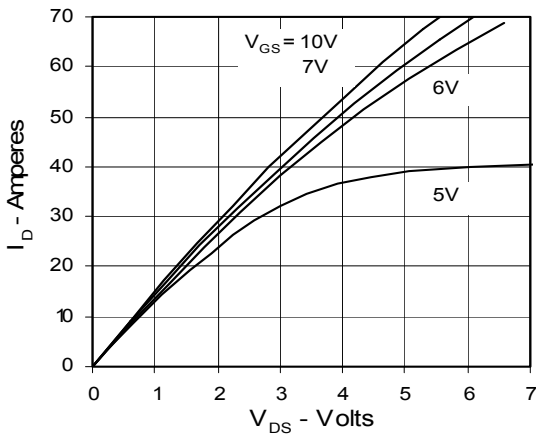

**Fig. 4.  $R_{DS(on)}$  Normalized to  $I_{D25}$  Value vs. Junction Temperature**

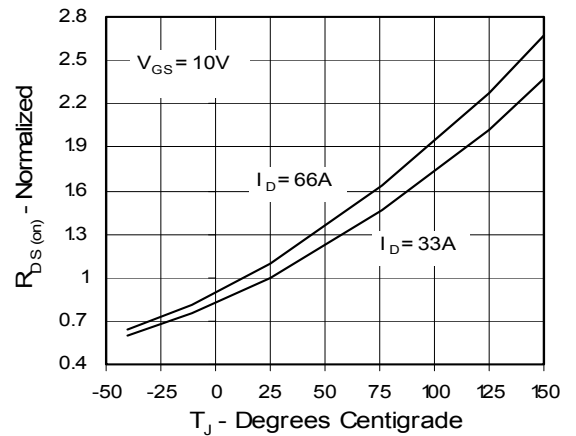

**Fig. 5.  $R_{DS(on)}$  Normalized to  $I_{D25}$  Value vs.  $I_D$**

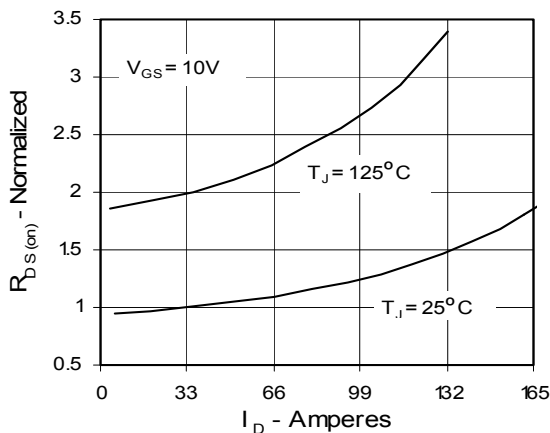

**Fig. 6. Drain Current vs. Case Temperature**

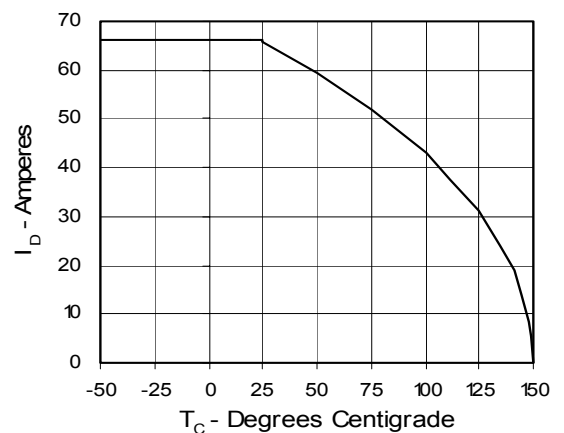

**Fig. 7. Input Admittance**

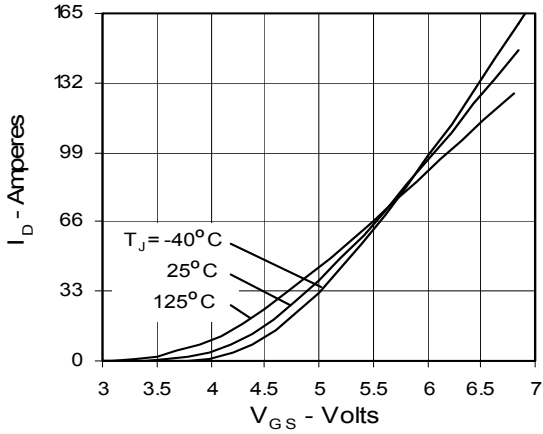

**Fig. 8. Transconductance**

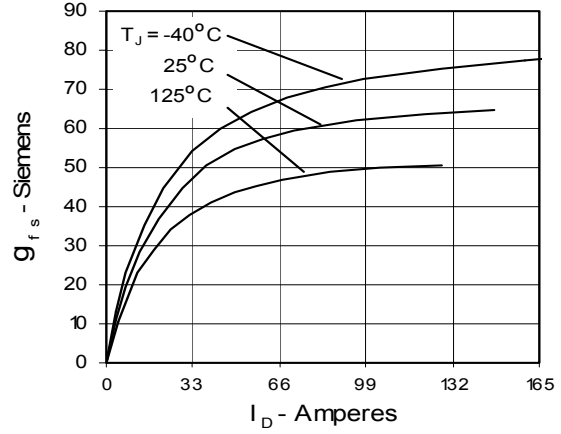

**Fig. 9. Source Current vs. Source-To-Drain Voltage**

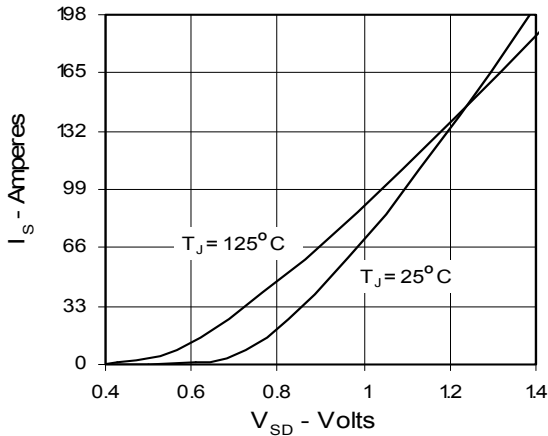

**Fig. 10. Gate Charge**

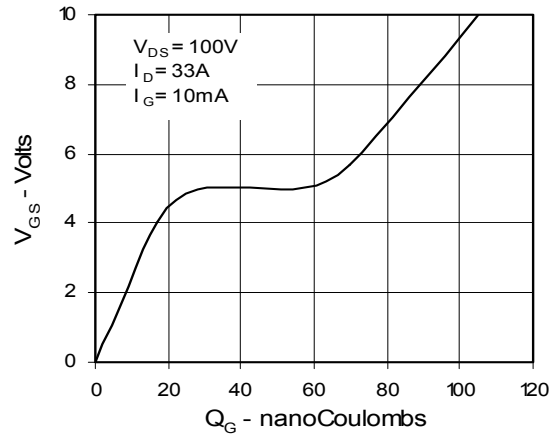

**Fig. 11. Capacitance**

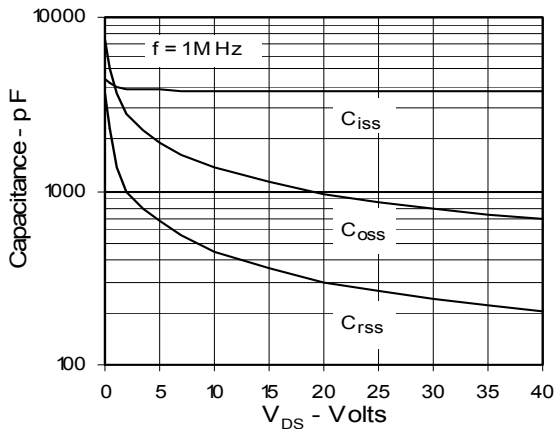

**Fig. 12. Maximum Transient Thermal Resistance**

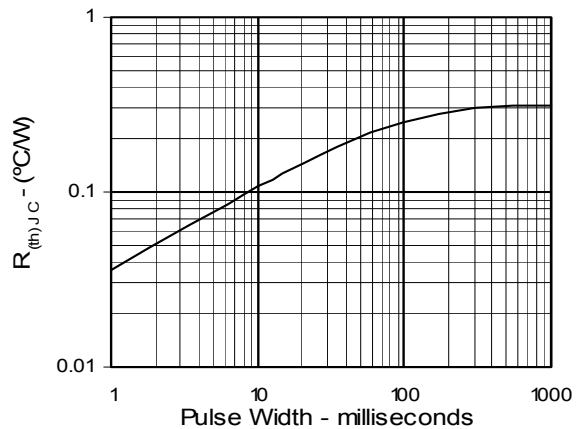

IXYS reserves the right to change limits, test conditions, and dimensions.

IXYS MOSFETs and IGBTs are covered by one or more of the following U.S. patents:

4,835,592 4,881,106 5,017,508 5,049,961 5,187,117 5,486,715 6,306,728B1 6,259,123B1 6,306,728B1  
4,850,072 4,931,844 5,034,796 5,063,307 5,237,481 5,381,025 6,404,065B1 6,162,665 6,534,343

## Looking for pricing, stock, or lifecycle information?

Click below to explore more details on WIN SOURCE:

 [View IXFH66N20Q on WIN SOURCE](#)

 [IXYS Information](#)

## Optimize Your Supply Chain with WIN SOURCE Solutions

-  Global Sourcing Solution
-  Obsolete Management
-  Cost Control Management
-  Shortage Management
-  Alternative Solution
-  Excess Inventory Management